

- ~ K 1697 SE-70 (Type name, HKSE-70)
- ~ K 1698 SE-110 (Type name, HKSE-110)
- SE-150 (Type name, HKSE-150)

EN This head light for DC power source from 5 to 16 V only. Do not use it to an AC power source (e.g. a dynamo)! Connecting over voltage power may cause the lamp to be destroyed!

Lights without switch function on it. Lights on and off control by e-bike system.

DE Dieser Scheinwerfer ist nur für eine Gleichspannungsstromquelle (DC) von 5 bis 16 V. Nicht an Wechselspannungsquelle (z.B. Dynamo) benutzen! Anschluss an Überspannung kann zur Zerstörung des Scheinwerfers führen! Scheinwerfer ohne Lichtschalter. Ein- und Ausschalten durch E-Bike System Bedieneinheit.

Hinweis: Die Texte in deutscher Sprache beinhalten teilweise zusätzliche Informationen die nur im Geltungsbereich der StVZO Gültigkeit haben.

Product Overview | Produktübersicht

Model No. HKSE70D / HKSE110D / HKSE150D

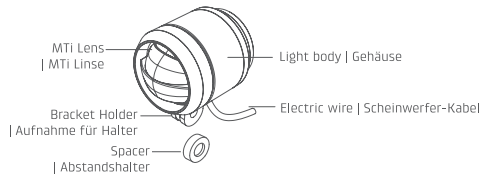

Product Include | Inhalt:

- 1 x Front light with electric wire | 1x Scheinwerfer mit Scheinwerfer-Kabel
- 1 x Spacer | 1x Abstandshalter

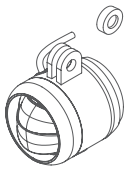

Model No. HKSE70U / HKSE110U / HKSE150U



Model No. HKSE110R / HKSE110L / HKSE150R / HKSE150L
To use with handlebar bracket
| Zur Verwendung mit Lenkerhalter
(Part no. HB31850)

Accessories | Zubehör

Optional accessories, depending on drive system and mounting position. | Optionales Zubehör, je nach Antriebssystem und Halterposition.

Aluminum HandleBar Bracket for Ø31.8 / 35mm | Aluminium CNC Lenkerhalter Ø31.8 / 35mm Part no. HB31850

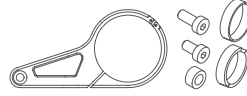

- 1 x Handle bar bracket | 1x Lenkerhalter
- 1 x M4 8mm bolt | 1 x M4 8mm Schraube
- 1 x M4 10mm bolt | 1 x M4 10mm Schraube
- 1 x 3.7mm spacer | 1 x 3.7mm Abstandshalter
- 2 x 0.5mm pad | 2 x 0.5mm pad
- 2 x 2.5mm pad | 2 x 2.5mm pad

Universal fork bracket | Universeller Kunststoff Gabelhalter Part no. FKPL

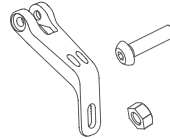

- 1 x Plastic fork bracket | Kunststoff Gabelhalter
- 1 x M5 20mm bolt | 1 x M5 20mm Schraube
- 1 x M5 4mm nut | 1 x M5 4mm Mutter

Bracket for SR Suntour NEX-E, NEX, CR8 | Halter für SR Suntour NEX-E, NEX, CR8 Part no. STU-1

Bracket for SR Suntour NCX-E | Halter für SR Suntour NCX-E Part no. STU-2

Bracket for SR Suntour SF20-NEX-E25 | Halter für SR Suntour SF20-NEX-E25 Part no. STU-4

Aluminum 2 Axles fork Bracket | Verstellbarer CNC Aluminium Gabelhalter Part no. FK2A

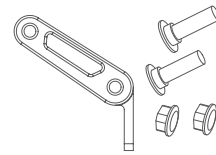

- 1 x 2 Axles fork bracket | 1x 2 Arme für Halter
- 2 x M5 Mutual to lock bolt | 2x M5 Halteschrauben
- 2 x M5 Mutual to lock nut | 2x M5 Kontermutter

Bracket for SR Suntour Mobie | Halter für SR Suntour Mobie Part no. STU-3

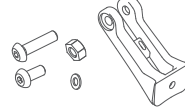

- 1 x Bracket for Suntour | 1x Halter für Suntour
- 1 x M5 20mm bolt | 1 x M5 20mm Schraube
- 1 x M5 4mm nut | 1 x M5 4mm Mutter
- 1 x M5 10mm bolt | 1 x M5 10mm Schraube
- 1 x M5 Washer | 1 x M5 Beilagscheibe

GoPro Style mount for Bosch Intuvia & Nyon | Halter für Bosch Intuvia & Nyon Part no. GO-B01

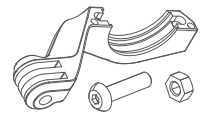

- 1 x Bracket for Bosch | 1 x Halter für Bosch
- 1 x M5 20mm bolt | 1 x M5 20mm Schraube
- 1 x M5 4mm nut | 1 x M5 4mm Mutter

Front K-Reflector | K-Reflektor vorne Part no. RF1



- 1 x Reflector | 1 x Reflektor

K-Reflector bracket + adapter | K-Reflektor mit Halterung Part no. RFD

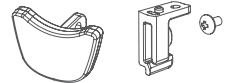

- 1 x Reflector | 1 x Reflektor
- 1 x Reflector bracket | 1 x Reflektor Halterung
- 1 x M3 6mm Philips bolt | 1 x M3 6mm Kreuz-schlitzschraube

Installation Guide | Installationsanleitung

A Mount on ø31.8 / ø35mm handlebar | ø31.8 / ø35mm Lenkerhalter

Available for HKSE110L / HKSE110R / HKSE150L / HKSE150R
| Verfügbar für HKSE110L / HKSE110R / HKSE150L / HKSE150R

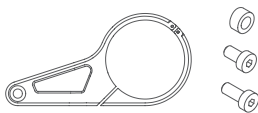

Include:

- 1 x Aluminum CNC HandleBar Bracket | 1 x Aluminium CNC Lenkerhalter
- 1 x M4 8mm bolt | 1 x M4 8mm Schraube
- 1 x M4 10mm bolt | 1 x M4 10mm Schraube
- 1 x 3.7mm spacer | 1 x 3.7mm Abstandshalter
- 2 x 0.5mm pad | 2 x 0.5mm pad
- 2 x 2.5mm pad | 2 x 2.5mm pad

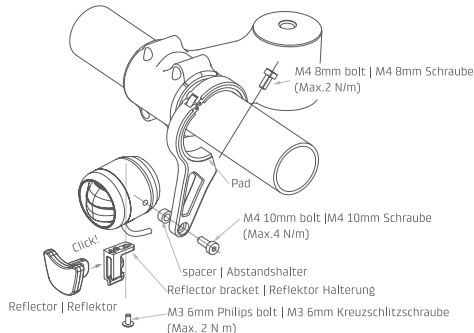

IMPORTANT! HORIZONTAL INSTALLATION - Both Light and Reflector Aligning
| **WICHTIG! HORIZONTALE INSTALLATION**. Beide, Scheinwerfer und Reflektor
parallel zur Fahrbahn ausrichten

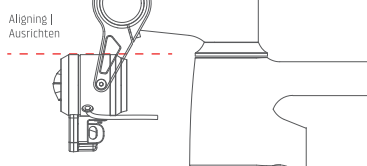

B Aluminum 2 axles fork bracket | Verstellbarer CNC Aluminium Gabelhalter

Available for HKSE70D / HKSE70U / HKSE110D / HKSE110U / HKSE150D / HKSE 150U
| Verfügbar für HKSE70D / HKSE70U / HKSE110D / HKSE110U / HKSE150D / HKSE150U

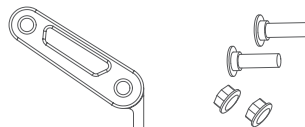

Include:

- 1 x 2 Axles fork bracket | 1x 2 Arme für Halter
- 2 x M5 Mutual to lock bolt | 2x M5 Halteschrauben
- 2 x M5 Mutual to lock nut | 2x M5 Kontermutter

Aluminum CNC Adjustable fork Bracket | Verstellbarer CNC Aluminium Gabelhalter

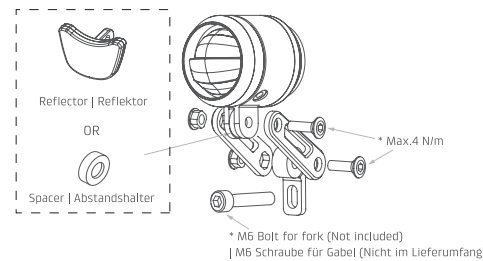

IMPORTANT! HORIZONTAL INSTALLATION - Both Light and Reflector Aligning
| **WICHTIG! HORIZONTALE INSTALLATION**. Beide, Scheinwerfer und Reflektor
parallel zur Fahrbahn ausrichten

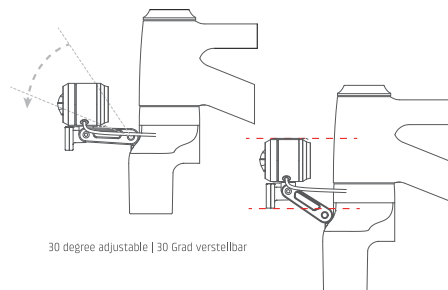

30 degree adjustable | 30 Grad verstellbar

C Mount under Bosch bike computer | Halter für Bosch Bedieneinheit

Available for HKSE70U / HKSE110U / HKSE150U
| Verfügbar für HKSE70U / HKSE110U / HKSE150U

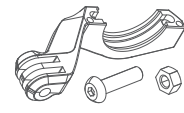

Include:

- 1 x Bracket for Bosch Intuvia | 1 x Halter für Bosch Intuvia
- 1 x M5 20mm bolt | 1 x M5 20mm Schraube
- 1 x M5 4mm nut | 1 x M5 4mm Mutter

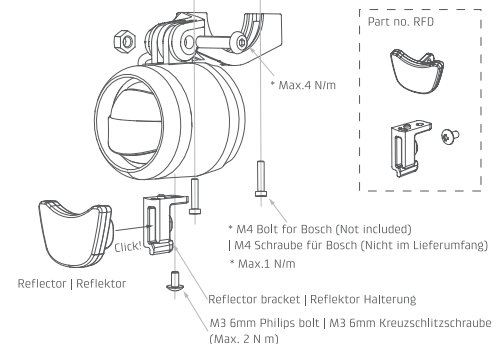

IMPORTANT! HORIZONTAL INSTALLATION | **WICHTIG! HORIZONTALE INSTALLATION**

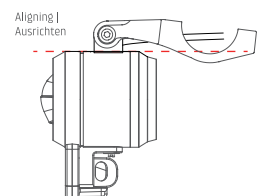

Aligning | Ausrichten

D Mount on Fork | Gabelhalter verfügbar
 Universal fork bracket | Universal Gabelhalter

Available for HKSE700 / HKSE1100 / HKSE1500
 | Verfügbar für HKSE700 / HKSE1100 / HKSE1500

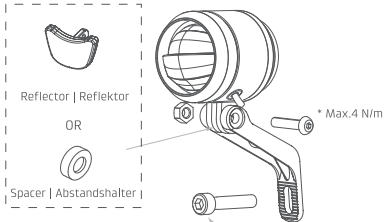

IMPORTANT! HORIZONTAL INSTALLATION | Both Light and Reflector Aligned
| WICHTIG! HORIZONTALE INSTALLATION. Beide, Scheinwerfer und Reflektor
 parallel zur Fahrbahn ausrichten

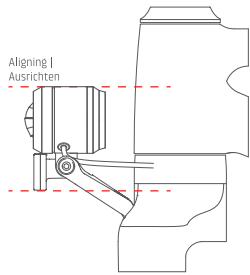

E Mount on SR-Suntour Fork | Halter an Suntour Gabel
 For SR Suntour Mobie | Für SR Suntour Mobie

Available for HKSE700 / HKSE1100 / HKSE1500
 | Verfügbar für HKSE700 / HKSE1100 / HKSE1500

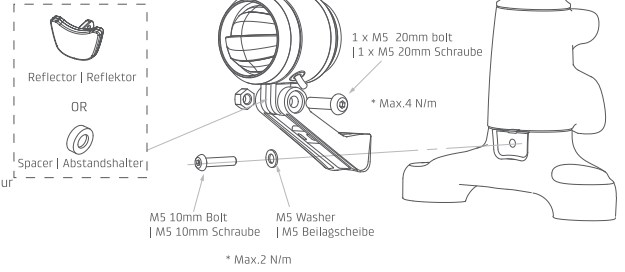
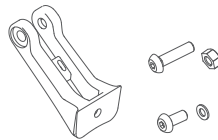

For SR Suntour NEX-E, NEX, CR8, NCX-E, SF-20-NEX-E25
| Halter für SR Suntour NEX-E, NEX, CR8, NCX-E, SF-20-NEX-E25

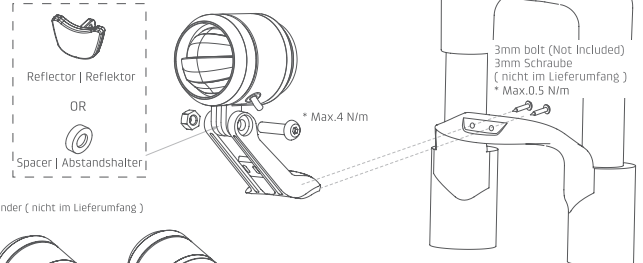
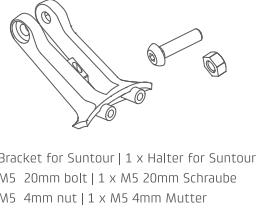

Cable Sorting Suggestion

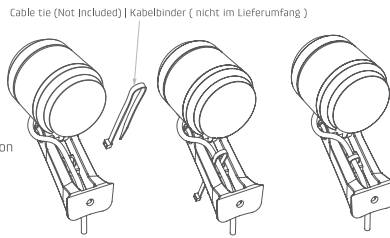

IMPORTANT! HORIZONTAL INSTALLATION | HORIZONTALE INSTALLATION
 Both Light and Reflector | Beide, Scheinwerfer und Reflektor
 parallel zur Fahrbahn ausrichten

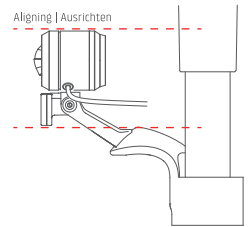

F On stem | Am Vorbau

Available for HKSE700 / HKSE1100 / HKSE1500
 | Verfügbar für HKSE700 / HKSE1100 / HKSE1500

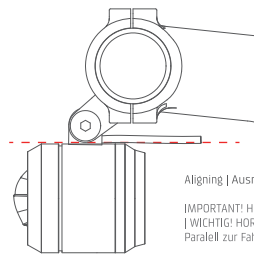
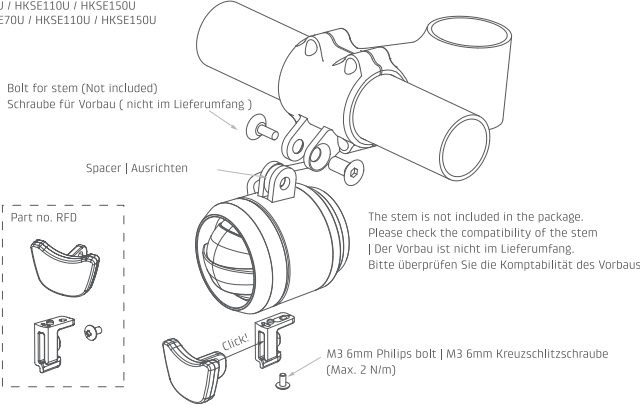

Technical Data | Technische Daten

These front lights have been developed for use on E-Bikes with speeds up to 25 km/h (Pedelects).
 | Diese Scheinwerfer sind für E-Bikes bis zu 25 km/h (Pedelects) entwickelt worden.

Model Name	SE-70	SE-110	SE-150
Model No.	HKSE700 / HKSE70D	HKSE1100 / HKSE110D HKSE110R / HKSE110L	HKSE1500 / HKSE150D HKSE150R / HKSE150L
Output Lichtleistung	70 lux / 300 lumen	110 lux / 550 lumen	150 lux / 750 lumen
Optical Technology Optische Technologie	MTi	MTi	MTi
Light Source Lichtquelle	High Intensity LED *1	High Intensity LED *2	High Intensity LED *2
Color of light emitted Lichtfarbe emittiert	6000K (5% tolerance)	6000K (5% tolerance)	6000K (5% tolerance)
Input Voltage Eingangsspannung	4.5 - 16V (DC)	4.5 - 16V (DC)	4.5 - 16V (DC)
Max Peak Current Maximaler Spitzenstrom	0.7A	0.8A	1A
Operating temperature Betriebstemperatur	-25--+70	-25--+70	-25--+70
Housing Gehäuse	Plastic	Aluminum Alloy / Plastic	Aluminum Alloy
Wire Stromkabel	AWG 24	AWG 24	AWG 24
Cable Length Kabellänge	450 / 1400mm	450 / 1400mm	450 / 1400mm
Weight Gewicht	66g	83g	91g
Dimension Masse	ø43.5 x 49 mm	ø43.5 x 53 mm	ø43.5 x 53 mm
IP Rating IP Einordnung	IP56	IP56	IP56
Wattage Leistung	2.7W	5.6W	7.2W

Caution | VORSICHT

EN

- When mounting the litemove light, please use the existing screws and rubber from the bracket from the package.
- Please take care to tighten the screws with the right torque shown on each model.
- Never use a high-pressure hose or alcohol-containing fluids to clean. Do not use aggressive cleaning agents (also no alcohol)
- According to StVZO §67, the light needs to be mounted properly ready for use.
- Prior to every ride, a secure and sturdy connection of the light to its mounting bracket and of the mounting bracket to the bicycle must be checked and ensured.
- Mounting height of the headlamp should be at least 250 mm and maximum 1200 mm above the ground.
- If an LED has failed, the headlight must be replaced accordingly.

DE

- Bei Installation des LITEMOVE Scheinwerfers bitte der Packung beiliegende Schrauben und Kleinteile verwenden.
- Bitte beachten Sie bei Anzug der Schrauben das richtige Anzugsmoment laut Aufdruck auf dem Produkt.
- Niemals hohen Luftdruck oder alkoholhaltige Flüssigkeiten zur Reinigung verwenden. Keine aggressiven Reiniger verwenden (ebenso keinen Alkohol)
- Nach StVZO §67 müssen die lichttechnischen Einrichtungen vorschriftsmäßig und fest angebracht sowie ständig betriebsfertig sein. Lichttechnische Einrichtungen dürfen nicht verdeckt sein.
- Stellen sie den Lichtkegel des Scheinwerfers so ein, dass die Mitte des Lichtkegels in 5m halb so hoch ist wie der Scheinwerfer selbst.
- Anbauhöhe des Scheinwerfers soll mindesten 400 mm und maximal bis 1200 mm über den Boden betragen.
- Wenn eine LED ausgefallen ist muss der Scheinwerfer ersetzt werden.