



M-WAVE

YOUR WORLD OF CYCLING



YOUR WORLD OF CYCLING

M-Wave, das sind erstklassige Produkte für alle Radfahrer, die insbesondere Funktion im Fokus haben. M-Wave bietet ein vollumfängliches Sortiment für Radfahrer mit technischem Anspruch, die auf der Suche nach innovativen und qualitativ wertigen Materialien sind.

Hinter M-Wave steht Entwicklung und Design aus Deutschland, eine Qualitätskontrolle auf höchstem Niveau, jahrelange praktische Erfahrung und das enorme Know-how von Europas größtem Importeur von Zweiradzubehör.

Das M-Wave Sortiment umfasst über 1000 Artikel mit überdurchschnittlichen Händlermargen, die weltweit in mehr als 70 Ländern verkauft werden.

M-Wave - these are first-class products for all cyclists who have a particular focus on function. M-Wave offers a complete range for cyclists with technical demand who are looking for innovative and quality materials.

M-Wave stands for development and design from Germany, a quality control at the highest level, many years of practical experience and the enormous know-how of Europe's largest importer of bicycle accessories.

The M-Wave range includes over 1000 items with above-average retail margins, sold in more than 70 countries worldwide.



ALL A CYCLIST NEEDS

Egal ob Regen oder Sonnenschein, Tag oder Nacht, M-Wave bietet die passende Lösung.

Whether rain or sunshine, day or night, M-Wave offers the right solution.



MAKE CYCLISTS HAPPY

Innovative Produkte, praktisches Design, bodenständige Preise: „Be happy“

Innovative products and functional designs at a fair price-ride with a smile!



QUALITY MATERIALS

M-Wave Produkte entsprechen den höchsten Qualitäts- und Fertigungsstandards.

M-Wave products meet with the highest quality and manufacturing standards.

PACKAGING DESIGN

Helles, leuchtendes Blau. Damit ziehen die konsequent einheitlich gestalteten M-Wave-Verpackungen die Aufmerksamkeit der Kunden auf sich.

Die optimierte Gestaltung der Verpackungen mit den wichtigsten Produktinformationen als Icons und zweisprachigen Stichpunkten gewährleistet, dass der Kunde sich schnell zurechtfindet und sich selbst bedienen kann. Die einheitliche Optik ermöglicht eine aufmerksamkeitsstarke, geschlossene Präsentation des M-Wave Sortiments in jedem Fachgeschäft.

Bright and brilliant blue. With this the uniformly designed M-Wave packaging attracts the attention of the customers.

The optimized design of the packaging with the most important product information as icons and bilingual bullet points ensures that the customer can quickly find his way and serve himself. The uniform look allows an eye-catching, closed presentation of the M-Wave assortment in every specialist shop.



M-WAVE SHOP SYSTEM

ALLES AUF EINEN BLICK - ALLES AUS EINER HAND

Laden Sie den Kunden zum Kaufen ein! Ein professionelles Shop-Design vermittelt Kompetenz, unterstützt Sie in der Beratung, begeistert Ihre Kunden und generiert profitablen Zusatzumsatz für Sie.

YOUR ONE-STOP - SHOP SOLUTION

Invite the customer to buy!

A professional shop design conveys competence, supports you in consulting, inspires your customers and generates profitable additional sales for you.

PREMIUM SLATWALL

Die Premium-Slatwall von M-Wave ermöglicht es Ihnen, die Produkte klar und übersichtlich zu präsentieren. Der Einsatz von PoS-Themenwelten führt Kunden gezielt zum Kontakt und Kennenlernen Ihrer Waren. Gerne unterstützen wir Sie mit thematischen und individuellen Bestückungsvorschlägen.

The premium Slatwall by M-Wave allows you to present the products clearly. The use of PoS theme worlds leads customers to a first contact and to get to know your goods. We are happy to assist you with thematic and individual assembly suggestions.



OUR WEBSHOP

Alle M-Wave Produkte sind in unserem Webshop www.messingschlager.com übersichtlich mit allen wichtigen Eigenschaften und Verkaufsargumenten dargestellt. Sie können dort einfach und schnell bestellt werden!

All M-Wave products are presented in our webshop www.messingschlager.com clearly arranged with all important features and sales arguments. Just order your products here easily and quickly!

www.messingschlager.com

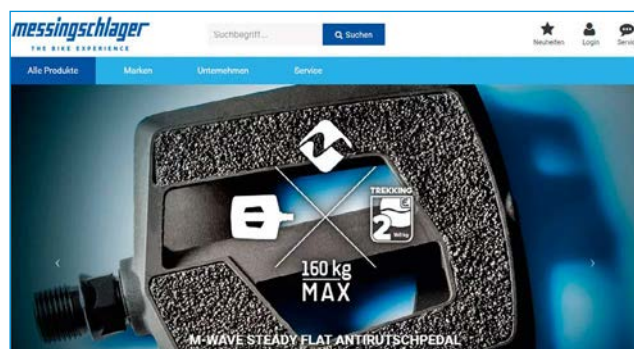

ART.-NR. UVP **BESCHREIBUNG**

DESCRIPTION

WARNWESTE ›VEST ILLU‹

- entspricht der europäischen Norm **EN 1150** für Warnbekleidung – bereits Pflicht in vielen europäischen Ländern wie Deutschland, Italien, ...
- 100 % Polyester
- mit **2 Reflexstreifen**
- **Weite sehr flexibel einstellbar** durch elastischen Gummibund und **verstellbaren** Klettverschlüssen
- im Polybeutel mit Euroloch

SAFETY VEST ›VEST ILLU‹

- conforms to European **EN 1150** for reflective clothing - already required in many European countries like Germany, Italy, ...
- 100 % polyester
- with **2 reflective tapes**
- **very flexible width adjustment** by using an elastic rubber band and **adjustable** hook and loop fasteners
- in PE bag with eurohole



Art. 120914



Art. 120915

120914 U
Kindergröße mit Motiv XXS-XS
5,99 €

child size with motive XXS-XS

120916 U
Größe S - M

size S - M

120915 U
Größe M - L

size M - L

120919 U
Größe XL - XXL
6,90 €

size XL - XXL

DREIECKSWESTE ›SASH ILLU‹

- **super leicht**, atmungsaktiv und mit **maximaler Bewegungsfreiheit**
- neongelbe Weste mit **Reflexstreifen** vorne, hinten und seitlich
- Universalgröße
- **Weite sehr flexibel einstellbar** durch elastischen Gummibund und **verstellbaren** Klettverschlüssen
- für alle Outdoor-Aktivitäten, z. B. Radfahren, Joggen, Walking, ...
- im Polybeutel mit Euroloch

TRIANGLE VEST ›SASH ILLU‹

- **super light**, breathable and offers **maximum mobility**
- neon yellow vest with **reflective tapes** at the front, rear and sides
- unisize
- **very flexible width adjustment** by using an elastic rubber band and **adjustable** hook and loop fasteners
- for all outdoor activities, e. g. cycling, jogging, walking, ...
- in PE bag with eurohole



120939 U
Größe XS /S

size XS /S

120940 U
Größe M / L

size M / L

120941 U
Größe XL / XXL
5,90 €

size XL / XXL

120908 U
LED-LEUCHTBAND ›WRAP FLASH‹
5,90 €

- für Arme, Beine, ...
- **3M Scotchlite® reflektierendes**, neongelbes Band
- 4 rote LEDs
- 2 Funktionen: Dauer- und Blinklicht
- bis zu 300 m und **360°** sichtbar
- für alle Outdoor-Aktivitäten, z. B. Joggen, Walking, ...
- inkl. Batterie (1x CR 2032, Art. 640816)
- in M-Wave Blisterverpackung

LED LIGHT STRAP ›WRAP FLASH‹

- for arms, legs, ...
- **3M Scotchlite® reflective**, neon yellow band
- 4 red LEDs
- 2 functions: steady and flashing light
- visibility up to 300 m and **360°**
- for all outdoor activities, e. g. jogging, walking, ...
- incl. battery (1x CR 2032, art. 640816)
- in M-Wave blister packaging

3M Scotchlite®
Reflective Material



360°

120903 U
HOSEN-/ARMBAND ›GEAR STRAP ILLU‹
3,90 €

- mit **Reflexstreifen**
- **Weite flexibel einstellbar** durch Gummieinlagen
- mit Klettverschluss
- paarweise im Polybeutel mit M-Wave Eurolochheader

TROUSERS/ARM STRAP ›GEAR STRAP ILLU‹

- with **reflective stripe**
- **flexible width adjustment** through rubber inserts
- with hook and loop fastener
- one pair in PE bag with M-Wave eurohole header



ART.-NR. UVP	BESCHREIBUNG	DESCRIPTION	
120902 U 3,90 €	HOSEN-/ARMBAND ›SNAP-WRAP‹ Einfach in geradem Zustand auf Arm oder Bein schlagen – fertig! • selbstrollend • neongelb • 30 x 340 mm • paarweise auf M-Wave Eurolochkarte	TROUSERS/ARM STRAP ›SNAP-WRAP‹ Just hit it on the arm or leg when it is uncurled - ready! • self coiling • neon yellow • 30 x 340 mm • one pair on M-Wave eurohole card	
120964 U	HOSENKLAMMERN ›ILLU PANTCLAMPS N‹ • Stahl • verchromt • mit Reflexstreifen paarweise im Polybeutel	TROUSERS CLAMPS ›ILLU PANTCLAMPS N‹ • steel • c. p. • with reflective stripe one pair in PE bag	
120965 U 3,50 €	paarweise auf M-Wave Eurolochkarte	one pair on M-Wave eurohole card	
120993 6,90 €	MAGNETKLAMMER ›ILLU LED‹ • 4 weiße LEDs • 2 Funktionen: Dauer- und Blinklicht • mit reflektierendem Material • schnelle, einfache, universelle und schonende Anbringung durch Magnetverschluss • für alle Outdoor-Aktivitäten, z. B. Joggen, Walking, ... • inkl. Batterie CR 2032 (Art. 640814) • auf M-Wave Eurolochkarte	MAGNET CLIP ›ILLU LED‹ • 4 white LEDs • 2 functions: steady and flashing light • reflective material • quick, easy, universal and gentle mounting through magnetic catch • for all outdoor activities e. g. jogging, walking, ... • incl. battery CR 2032 (art. 640814) • on M-Wave eurohole card	
120994 U 2,90 €	MAGNET ILLU ›MAGNET ILLU‹ • aus reflektierendem Material • schnelle, einfache, universelle und schonende Anbringung durch Magnetverschluss • auf M-Wave Eurolochkarte	MAGNET ILLU ›MAGNET ILLU‹ • reflective material • quick, easy, universal and gentle mounting through magnetic catch • on M-Wave eurohole card	
120990 U 5,90 €	REFLEXAUFKLEBER ›REFLICKERS SMILE‹ • 3M Scotchlite - Qualität • 4 gelbe Sticker mit schwarzem Aufdruck: 2 x Smile, 2 x 3M-Logo • auf M-Wave Eurolochkarte	REFLECTIVE STICKERS ›REFLICKERS SMILE‹ • 3M Scotchlite quality • 4 yellow stickers with black imprint: 2 x smile, 2 x 3M logo • on M-Wave eurohole card	
120901 5,90 €	REFLEKTOR FÜR SATTELGESTELL ›REFLICKER SWING‹ • schnelle, einfache Anbringung • aus reflektierendem Material „ 3M Diamond “ • erhöht Aufmerksamkeit durch schwingende Befestigung oder Fixierung mit Kabelbinder • zweifarbig: rot und gelb • Größe ca. 89 x 60 mm • mit M-Wave Eurolochheader	REFLECTOR FOR SADDLE RAIL ›REFLICKER SWING‹ • quick, easy mounting • reflective material “ 3M Diamond “ • increases attention by swinging mounting or fixation with cable ties • 2 colorway: red and yellow • size approx. 89 x 60 mm • with M-Wave eurohole header	

3M Scotchlite
Reflective Material

3M Scotchlite
Reflective Material

ART.-NR. UVP **BESCHREIBUNG**

DESCRIPTION

- 120992 U**
4,90 €
- REFLEXAUFKLEBER ›REFLICKERS BOW‹**
- **3M Scotchlite® - Qualität**
 - **leicht gebogene Form**
 - **1 Set = 16 Stück (8 x weiß, 8 x gelb)**
 - ca. 0,7 x 10 cm
 - auf M-Wave Eurolochkarte

- REFLECTIVE STICKERS ›REFLICKERS BOW‹**
- **3M Scotchlite® quality**
 - **slightly curved shape**
 - **1 set = 16 pieces (8 x white, 8 x yellow)**
 - approx. 0.7 x 10 cm
 - on M-Wave eurohole card

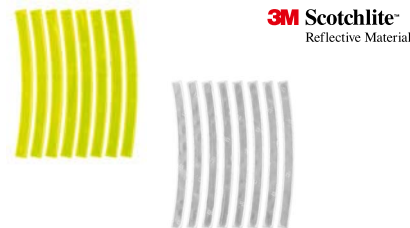

Anbringung auf Felgen im Geltungsbereich der StVZO (Deutschland) unzulässig, da ohne deutsches Prüfzeichen.

- 120970 U**
14,90 €
- ABSTANDSFAHNE ›SF LONG‹**
- **klappbar**
 - mit 1 roten LED
 - mit **Bewegungssensor**
 - zur Montage am Gepäckträger oder an der Sitzrohrstrebe (Ø 8 - 20 mm!)
 - Dreiecksflagge mit **Reflexstreifen**
 - Länge Ausleger: 360 mm
 - Größe Fahne: 200 x 120 mm
 - im Polybeutel mit M-Wave Euroloch-header

- SAFETY FLAGPOLE ›SF LONG‹**
- **foldable**
 - with 1 red LED
 - with **movement sensor**
 - to be mounted on the rear carrier or on the seat stay (Ø 8 - 20 mm!)
 - triangle flag with **reflective tapes**
 - length extension arm: 360 mm
 - flag size: 200 x 120 mm
 - in PE bag with M-Wave eurohole header

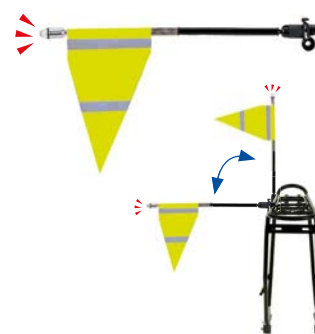

Ohne deutsches Prüfzeichen - Verkauf und Nutzung im Geltungsbereich der StVZO (Deutschland) unzulässig (Abgabe nur an außerdeutsche Kunden).

- 120971 U**
5,90 €
- ABSTANDSFAHNE ›SF SHORT‹**
- mit Sicherheitsende
 - Länge Ausleger: 380 mm
 - zur Montage am Gepäckträger
 - im Polybeutel mit M-Wave Euroloch-header

- SAFETY FLAGPOLE ›SF SHORT‹**
- with safety end
 - length extension arm: 380 mm
 - to be mounted on the rear carrier
 - in PE bag with M-Wave eurohole header



- 120975 U**
3,99 €
- WIMPELSTANGE**
- zur Montage an der Hinterradachse
 - ideal für Kinder- und Lauflernfahrräder
 - 150 cm
 - in der Mitte **teilbar**
 - im Polybeutel

- SECURITY FLAG**
- for mounting on the rear hub axle
 - ideal for children and running bikes
 - 150 cm
 - **divisible** in the middle
 - in PE bag

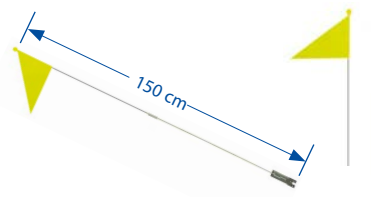

-  **FAHRRADHANDSCHUHE ›SECURE‹**
- **360° reflektierende** Applikationen
 - mit **non-slip-Noppen**
 - Daumen und Zeigefinger mit spezieller Einlage zur **Touchscreenbedienung**
 - mit **Ausziehhilfe**
 - außen teilweise aus **elastischem Lycra**
 - waschbar
 - atmungsaktiv
 - elastischer Bund
 - auf M-Wave Eurolochkarte

- BICYCLE GLOVES ›SECURE‹**
- **360° reflective** applications
 - with **non-slip knobs**
 - thumb and forefinger with contact area for **touchscreen operation**
 - with loops as **take-off assistance**
 - outside partly made of **elastic lycra**
 - washable
 - breathable
 - elastic waistband
 - on M-Wave eurohole card



- 719890 U** Größe S
- 719891 U** Größe M
- 719892 U** Größe L
- 719893 U** Größe XL
14,90 €

- size S
- size M
- size L
- size XL

- 715206 U**
5,90 €
-  **HALS-/KOPFTUCH ›NEON YELLOW‹**
- 100 % Polyester **Funktions-Microfaser**
 - **nahtlos, elastisch** und **atmungsaktiv**
 - Größe: ca. 24 x 48 cm
 - auf M-Wave Eurolochkarte

- TUBULAR HEADWEAR ›NEON YELLOW‹**
- 100 % Polyester **function microfibre**
 - **seamless, elastic** and **breathable**
 - size: approx. 24 x 48 cm
 - on M-Wave eurohole card



ART.-NR. UVP **BESCHREIBUNG**

DESCRIPTION

KINDERHELM ›SMILE‹

- **Microshell** Oberschale
- große **Durchlüftungsöffnungen** mit **Mückenschutz**
- gelb
- integriertes **Visier**
- kinderleichtes Verschlusssystem
- an Kopfgröße anpassbar durch universelles, austauschbares **Ring-Kopfgrößeneinstellsystem**
- im M-Wave Einzelkarton

730231 ›Smile‹
Größe **XS, 46 - 52 cm** Kopfumfang

730230 ›Smile‹
Größe **S, 52 - 57 cm** Kopfumfang
24,90 €

CHILDREN HELMET ›SMILE‹

- **Microshell** face plate
- big **holes for air circulation** with **fly net**
- yellow
- integrated **visor**
- very simple closing
- adjustable to head size by universal, interchangeable **ring head size adjustment system**
- in M-Wave box

›Smile‹
size **XS, 46 - 52 cm** head size

›Smile‹
size **S, 52 - 57 cm** head size

according to EN 1078



HELMÜBERZUG

- **Regenschutz**
- **wasserabweisend**
- atmungsaktiv
- neongelb mit **Reflex-Logo**
- auf M-Wave Eurolochkarte

120997 ›Kids‹
Kindergröße XS - S

120998 ›Peter‹
Größe M - L
6,49 €

HELMET COVER

- **rain shelter**
- **water resistant**
- breathable
- neon yellow with **reflective** logo
- on M-Wave eurohole card

›Kids‹
children size XS - S

›Peter‹
size M - L



120995 HELMÜBERZUG ›MAASTRICHT‹

7,90 €



- **komplett reflektierend für maximale Sichtbarkeit**
- **Regenschutz**
- wasserabweisend
- durch Zugkordel für alle Größen anpassbar
- auf M-Wave Eurolochkarte

HELMET COVER ›MAASTRICHT‹

- **full reflex material for highest visibility**
- **rain shelter**
- waterproof
- adjustable by drawstring for all sizes
- on M-Wave eurohole card



122352 KORB + TASCHENÜBERZUG ›MAASTRICHT PROTECT‹

11,90 €

- **universeller** Regenschutz für **Körbe**, Rucksäcke bis ca. 25 Liter, Vorderradtaschen, Gepäcktaschen, ...
- mit **2 Haltegurten** auf der Rückseite
- neongelb
- **3M Scotchlite® Reflexstreifen** auf drei Seiten
- mit aufgesetzter Netztasche
- auf M-Wave Eurolochkarte

BASKET + BAG COVER ›MAASTRICHT PROTECT‹

- **universal** rain protection for **baskets**, back bags up to approx. 25 litres, front bags, rear bags, ...
- with **2 fixation straps** on back
- neon yellow
- **3M Scotchlite® reflective stripes** on three sides
- with fitted net pocket
- on M-Wave eurohole card



SPEICHENREFLEKTOR

- **3M Scotchlite®** Reflexmaterial
- **360° Sichtbarkeit**
- Länge: 70 mm
- einfache, werkzeuglose Montage
- mit **deutschem Prüfzeichen** (gültig bei Anbringung an 36 Speichen in einem Laufrad)

466670 1 Set = 18 Stück
in M-Wave Blisterverpackung
9,90 €

• **466671** Montageverpackung
0,55 €

SPOKE REFLECTOR

- **3M Scotchlite®** reflective material
- **360° visibility**
- length: 70 mm
- easy, toolless mounting
- with **German approval number** (applies only when mounted on 36 spokes in one wheel)

1 set = 18 pcs
in M-Wave blister packaging

OEM



BIKEPACKING

M-WAVE BIKEPACKING-SERIE

- besonders reißfestes Ripstop-Gewebe
- 100 % wasserdicht
- jede Menge Stauraum
- extrem belastbar
- viele clevere Features

M-WAVE BIKEPACKING-SERIES

- high tear-resistant ripstop fabric
- 100 % waterproof
- lots of storage space
- extremely resilient
- many clever features



Bags

ART.-NR. BESCHREIBUNG

DESCRIPTION



SATTeltasche 'ROUGH RIDE SADDLE'

- zum Transport von **Gepäck ohne Gepäckträger**
- **100 % wasserdicht**
- **Rollverschluss** für universelle Größeneinstellung
- hohe Reißfestigkeit durch verstärktes Ripstop-Gewebe
- sichere Befestigung mit zwei breiten Klettverschlüssen
- aufgesetzte Gepäckgurte und Schlaufen zur zusätzlichen Gepäckbefestigung, zur Anbringung einer Beleuchtung, Schutzblech, Luftpumpe, ...



- **Größe L**
- Volumen bis ca. 11 Liter
- ca. 53 x 13 x 15 cm

122630 U schwarz/blau

122636 U neon gelb, besonders gute **Sichtbarkeit** durch **leuchtende Farbe** und **Reflexaufdruck**
39,90 €

SADDLE BAG 'ROUGH RIDE SADDLE'

- to transport **luggage without carrier**
- **100 % waterproof**
- **roll cover** for individual size adjustment
- high tensile strength through reinforced ripstop textile
- secure mounting with two wide hook and loop fasteners
- attached luggage belts and loops for the additional luggage connection, for attachment of lights, mudguard, pumps, ...

- **size L**
- volume approx. 11 litres
- approx. 53 x 13 x 15 cm

black/blue

neon yellow, very good **visibility** due to **bright colour** and **reflective print**



122625 U **Größe M**
29,90 €
• Volumen bis ca. 6 Liter
• ca. 46 x 9 x 11 cm
• schwarz/blau



- **size M**
- volume approx. 6 litres
- approx. 46 x 9 x 11 cm
- black/blue

ART.-NR. BESCHREIBUNG
UVP

DESCRIPTION

LENKERTASCHE
›ROUGH RIDE FRONT‹

- einzeln verwendbarer, **100 % wasserdichter Packsack mit Rollverschluss**
- hohe Reißfestigkeit durch verstärktes Ripstop-Gewebe
- **abnehmbares, transparentes Kartenfach** (Art. 122639)
- sichere Befestigung mit drei universell versetzbaren Klettverschlüssen
- Volumen bis ca. 10 Liter
- ca. 59 x 23 cm

122631 schwarz / blau
U

122637 neongelb, besonders gute **Sichtbarkeit** durch **leuchtende Farbe** und **Reflexaufdruck**
U
32,90 €

HANDLEBAR BAG
›ROUGH RIDE FRONT‹

- solo useable, **100 % waterproof duffel with roll cover**
- high tensile strength through reinforced ripstop textile
- **removable, transparent card container** (art. 122639)
- secure mounting with three universally displaceable hook and loop fasteners
- volume approx. 10 litres
- approx. 59 x 23 cm

black / blue

neon yellow, very good **visibility** due to **bright colour** and **reflective print**



RAHMEN-DREIECKSTASCHE
›ROUGH RIDE TRIANGLE‹

- **wasserdichter Reißverschluss und 100 % wasserdichte Innenauskleidung**
- **Volumen vergrößerbar** auf bis zu 4,2 Liter
- variable Unterteilungsmöglichkeit des Hauptfachs
- hohe Reißfestigkeit durch verstärktes Ripstop-Gewebe
- sichere Befestigung mit fünf universell versetzbaren Klettverschlüssen (Art. 122627)
- vier aufgesetzte Netztaschen für schnellen Zugriff auf wichtige Kleinutensilien
- ca. 42 x 14 - 25 cm

122632 schwarz / blau
U

122638 neongelb, besonders gute **Sichtbarkeit** durch **leuchtende Farbe** und **Reflexaufdruck**
U
44,90 €

FRAME TRIANGLE BAG
›ROUGH RIDE TRIANGLE‹

- **waterproof zipper and 100 % waterproof inner lining**
- **volume flexible** up to 4.2 litres
- variable dividing possibilities of the main compartment
- high tensile strength through reinforced ripstop textile
- secure mounting with five universally displaceable hook and loop fasteners (art. 122627)
- four attached net pockets for quick access to important small utensils
- approx. 42 x 14 - 25 cm

black / blue

neon yellow, very good **visibility** due to **bright colour** and **reflective print**

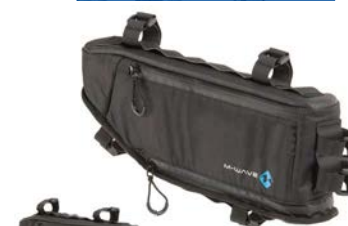

OBERROHRTASCHE
›ROUGH RIDE TOP‹

- **wasserdichter Reißverschluss und wasserdichte Innenauskleidung**
- sichere Befestigung mit drei universellen Klettverschlüssen
- erschütterungsabsorbierende, weiche Polstereinlage
- verstärkter Boden
- ca. 7 x 8,5 x 29 cm

122633 schwarz
U

122640 neongelb, besonders gute **Sichtbarkeit** durch **leuchtende Farbe** und **Reflexaufdruck**
U
21,90 €

TOP TUBE BAG
›ROUGH RIDE TOP‹

- **waterproof zipper and waterproof inner lining**
- secure mounting with three universal hook and loop fasteners
- shock absorbing, soft padding
- reinforced bottom
- approx. 7 x 8,5 x 29 cm

black

neon yellow, very good **visibility** due to **bright colour** and **reflective print**



ART.-NR. UVP BESCHREIBUNG

DESCRIPTION

BIKER SPEZIAL-RUCKSACK ›ROUGH RIDE BACK‹

- **gepolsterte, atmungsaktive Schultertragegurte und Beckengurt**
- zusätzlicher, verstellbarer Brustgurt
- Tragegestell und anpassbares Rückennetzteil für **optimal belüfteten Tragekomfort**
- **integrierter Regenüberzug**
- **inkl. abnehmbarem Helmaufbewahrungsnetz**
- 1 Hauptfach und 4 kleinere Fächer mit Reißverschluss
- integriertes **isoliertes** Fach für **Trinkblase**
- zusätzlich 2 äußere Fächer und 1 großes Innenfach
- mit Rücklichthalter
- Volumen ca. 15 Liter
- ca. 46 x 28 x 12 cm

BIKER SPECIAL BACKPACK ›ROUGH RIDE BACK‹

- **padded, breathable shoulder straps and waist belt**
- additional, adjustable chest belt
- carrying structure and adaptable back net for **optimally ventilated wearing comfort**
- **integrated rain cover**
- **incl. detachable helmet storage net**
- 1 main compartment and 4 smaller pockets with zipper
- integrated **insulated** compartment for **water bag**
- additionally 2 outer compartments and 1 big inner compartment
- with rear light strap
- volume approx. 15 litres
- approx. 46 x 28 x 12 cm



122634 schwarz / blau
U
10

black / blue

122635 neongelb, besonders gute Sichtbarkeit durch leuchtende Farbe und Reflexaufdruck
U
46,90 €

neon yellow, very good **visibility** due to **bright colour** and **reflective print**



BIKER RUCKSACK ›ROUGH RIDE BACK‹ INKL. WASSERBLASE ›SOURCE‹

- Hochwertige Wasserblase ›SOURCE‹** (Art. 122515)
- 2-Liter-Wasserblase mit **antibakterieller Innenbeschichtung**
 - 2.000 % **glattere Oberfläche** als herkömmliche TPU-Folien beugt Schimmelbildung vor
 - **große Öffnung** für schnelles und leichtes Befüllen und Reinigen
 - **geschmacksneutral** und **frei von BPA und Phthalaten**
 - Trinkschlauch mit **antibakterieller Innenbeschichtung** und **auswechselbarem Silikon-Mundstück** (Art. 122516)

BIKER BACKPACK ›ROUGH RIDE BACK‹ INCL. WATER BAG ›SOURCE‹

- high-quality water bag ›SOURCE‹** (art. 122515)
- 2-litres-water bag with **antimicrobial protection inside**
 - 2,000 % **smoother surface** than conventional TPU foils prevents mould formation
 - **big opening** for fast and easy filling and cleaning
 - **tasteless and free from BPA and phthalates**
 - drinking tube with **antimicrobial protection inside** and **exchangeable silicone bite valve** (art. 122516)



122620 schwarz / blau

black / blue

122621 neongelb, besonders gute Sichtbarkeit durch leuchtende Farbe und Reflexaufdruck
59,90 €

neon yellow, very good **visibility** due to **bright colour** and **reflective print**

122538 **E-BIKE AKKUTASCHE ›ROUGH RIDE B‹**
U
37,90 €



- universeller, gepolsterter **Transport-schutz** für Unterrohr- und Gepäck-trägerakkus
- **100% wasserdicht**
- Rollverschluss ermöglicht **variable Größeneinstellung**
- hohe Reißfestigkeit durch verstärktes Ripstop-Gewebe
- **universelle** und **sichere** Befestigung durch breite Klettverschlüsse am **Rahmenrohr, Gepäckträger, ...**
- mit non-slip Einlagen und **Reflexlogo**
- Größe: ca. 55 x 8,5 x 13 cm (L x B x H)
- Volumen ca. 7 L

E-BIKE BATTERY BAG ›ROUGH RIDE B‹

- universal, padded **transport protection** for down tube and carrier batteries
- **100% waterproof**
- **expandable** via roll cover
- high tear resistance through reinforced ripstop textile
- **universal** and **secure** mounting to the **frame tube, carrier, ...** with wide hook and loop fasteners
- with non-slip inlays and **reflex** logo
- size: approx. 55 x 8.5 x 13 cm (L x W x H)
- volume approx. 7 litres





ART.-NR. UVP **BESCHREIBUNG**

DESCRIPTION

122881 GEPÄCKTRÄGERTASCHE

54,90 €

›SUBURBAN CARRY‹

- **100 % wasserdicht** und staubdicht
- mit **verschweißten Nähten**
- sehr stabil und strapazierfähig trotz geringem Gewicht
- **Rollverschluss** für universelle Größeneinstellung
- mit entnehmbarer **Innentasche**
- integrierte Seitentasche mit **verschweißtem Reißverschluss**
- mit flexiblem Gummiband-Helmalter
- stabiler, verstellbarer **Clip-on**-Halter zur sekundenschnellen (De-)Montage über **Griffzug** an Gepäckträgerrohren von 9 - 16 mm (Ersatzhaken Art. 122889)
- zusätzliche **3. Fixierungsmöglichkeit** an der Gepäckträgerstrebe
- mit **Reflexaufdruck**
- Größe ca. 33 x 14,5 x 61 cm (L x B x H)
- Volumen ca. 25 Liter

CARRIER SINGLE BAG

›SUBURBAN CARRY‹

- **100 % waterproof** and dustproof
- with **heat-sealed joints**
- very stable and durable despite low weight
- **roll cover** for individual size adjustment
- with detachable **inner bag**
- integrated side pocket with **heat-sealed zipper**
- with flexible rubber strap helmet holder
- firm, adjustable **clip-on** bracket for (de-)mounting within seconds by **pulling the handle** on carrier tubes of 9 - 16 mm (replacement hook art. 122889)
- additional **3rd mounting option** at the luggage stay
- with **reflective print**
- size approx. 33 x 14.5 x 61 cm (L x W x H)
- volume approx. 25 litres

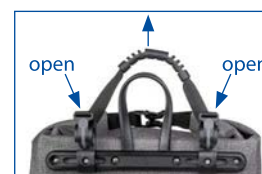

122882 LENKERTASCHE

39,90 €

›SUBURBAN FRONT‹



- **100 % wasserdicht** und staubdicht
- mit **verschweißten Nähten**
- sehr stabil und strapazierfähig trotz geringem Gewicht
- **Rollverschluss** für universelle Größeneinstellung
- **wasserdichtes, transparentes Sichtfenster** zur Bedienung eines **Touch-displays**
- integrierte Seitentaschen mit **verschweißtem Reißverschluss**
- stabiler 2-Punkt **Clip-on**-Halter mit einfacher (De-)Montage, passend für Lenker-Ø **22,2 - 31,8 mm** (Art. 122709)
- absolut **verdrehsicher**
- innen mit zusätzlicher Versteifung
- mit Schultergurt
- mit **Reflexaufdruck**
- Größe ca. 13 x 28 x 21 cm (L x B x H)
- Volumen ca. 7 Liter

HANDLEBAR BAG

›SUBURBAN FRONT‹

- **100 % waterproof** and dustproof
- with **heat-sealed joints**
- very stable and durable despite low weight
- **roll cover** for individual size adjustment
- **waterproof, transparent window** for operating a **touch display**
- integrated side pockets with **heat-sealed zipper**
- stable 2-point **clip-on** bracket with easy (de-)mounting, suitable for handlebar Ø **22.2 - 31.8 mm** (art. 122709)
- absolutely **anti-twist**
- additional internal stiffness
- with shoulder strap
- with **reflective print**
- size approx. 13 x 28 x 21 cm (L x W x H)
- volume approx. 7 litres

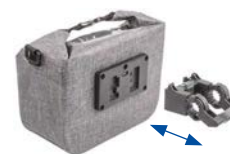

122736 Ersatz-/Zweit-Halter, passend für **E-Bike-Mitteldisplays**, für Art. 431515, 121920, 122882, auf M-Wave Eurolochkarte

19,90 €



replacement/second bracket, suitable for **e-bike center displays**, for art. 431515, 121920, 122882, on M-Wave eurohole card



122883 OBERROHRTASCHE

17,90 €

›SUBURBAN TOP‹



- **100 % wasserdicht** und staubdicht
- mit **verschweißten Nähten und Reißverschluss**
- sehr stabil und strapazierfähig trotz geringem Gewicht
- **wasserdichtes, transparentes Sichtfenster** zur Bedienung eines **Touch-displays**
- für große Smartphones, wie iPhone X
- sichere Befestigung mit 3 Klettverschlüssen
- verstärkter Boden
- mit **Reflexaufdruck**
- Größe ca. **18,5 x 9,5 x 8,5 cm** (L x B x H)

TOP TUBE BAG

›SUBURBAN TOP‹

- **100 % waterproof** and dustproof
- with **heat-sealed joints and zipper**
- very stable and durable despite low weight
- **waterproof, transparent window** for operating a **touch display**
- for big smartphones like iPhone X
- secure mounting with 3 hook and loop fasteners
- reinforced bottom
- with **reflective print**
- size approx. **18.5 x 9.5 x 8.5 cm** (L x W x H)





ART.-NR. **BESCHREIBUNG**
UVP

DESCRIPTION

122884 **SATTELTASCHE**
U
17,90 €
›SUBURBAN SADDLE‹

- **100 % wasserdicht** und staubdicht
- mit **verschweißten Nähten**
- sehr stabil und strapazierfähig trotz geringem Gewicht
- sichere Befestigung mit 3 Klettverschlüssen
- **Rollverschluss** für universelle Größeneinstellung
- mit **Reflexaufdruck**
- Größe ca. 20 x 9 x 9 cm (L x B x H)
- Volumen max. 2,5 Liter

SADDLE BAG
›SUBURBAN SADDLE‹

- **100 % waterproof** and dustproof
- with **heat-sealed joints**
- very stable and durable despite low weight
- secure mounting with 3 hook and loop fasteners
- **roll cover** for individual size adjustment
- with **reflective print**
- size approx. 20 x 9 x 9 cm (L x W x H)
- volume max. 2.5 litres



122888 **SCOOTER-/LENKERTASCHE**
U
21,90 €
›SUBURBAN MESSENGER COMPACT‹

- **100% wasserdicht** und staubdicht
- mit **verschweißten Nähten**
- zusätzliche Außentasche
- sehr stabil und strapazierfähig trotz geringem Gewicht
- mit gepolstertem, verstellbarem Schultergurt
- mit **Einschubtasche** am Schultergurt für Smartphones, ...
- sichere Befestigung durch vier Klettverschlüsse an Fahrrädern, Rollern, ...
- mit **Reflexaufdruck**
- Größe ca: 23 x 10,5 x 33 cm (L x B x H)
- Volumen max. 8 Liter

SCOOTER/HANDLEBAR BAG
›SUBURBAN MESSENGER COMPACT‹

- **100% waterproof** and dustproof
- with **heat-sealed joints**
- additional outer pocket
- very stable and durable despite low weight
- with padded, adjustable shoulderstrap
- with **slide-in pocket** at the shoulderstrap for smartphones, ...
- secure mounting with four hook and loop fasteners to bicycles, scooters, ...
- with **reflective print**
- size approx. 23 x 10.5 x 33 cm (L x W x H)
- volume max. 8 litres



CANADA PRO



CANADA PRO



CANADA PRO



GEPÄCKTRÄGERTASCHE

- **100 % wasserdicht** durch **verschweißte Nähte**
- extrem **strapazierfähiges** Material
- stabiler **Rixen & Kaul Clip-on**-Halter zur sekundenschnellen (De-)Montage an **Gepäckträgerrohren von 5 - 12 mm!** (Ersatzhaken = Art. 122702)
- zusätzliche **3. Fixierungsmöglichkeit** an der Gepäckträgerstrebe (Ersatzhaken = Art. 122712)
- Rollverschluss
- **zusätzlicher** Schutz durch **Deckelverschlussklappe**
- mit **Tragegriffen** und Befestigungsringen für Schultergurt (Art. 122700)
- Clip-Befestigungsmöglichkeiten für Packsack Art. 122730
- **Verstärkungen** an der Unterseite
- **Rücken- und Kantenschutz**
- mit **Reflexstreifen**
- paarweise im Polybeutel

BICYCLE CARRIER BAG

- **100 % waterproof** through **heat-sealed joints**
- extremely **tough** material
- stable **Rixen & Kaul clip-on** bracket for (de-)mounting within seconds on **tubes of carrier from 5 - 12 mm!** (replacement hook = art. 122702)
- additional **3. mounting option** on the side bars of the carrier (replacement hook = art. 122712)
- roll cover
- **additional** protection by **top cover**
- with **handle** and fixation rings for shoulder strap (art. 122700)
- clip fixing possibility for duffle bag art. 122730
- **reinforcements** at the bottom
- with **rear and edge protection**
- with **reflective stripes**
- one pair in PE bag



›ALBERTA‹
Volumen ca. **2 x 20 Liter**

›ALBERTA‹
volume approx. **2 x 20 litres**

122720 schwarz
U

black

122728 rot

red

124,90 €/pair

122724 ›MANITOBA‹
U
99,90 €/pair
Volumen ca. **2 x 12,5 Liter**

›MANITOBA‹
volume approx. **2 x 12.5 litres**

Bags

ART.-NR. BESCHREIBUNG
UVP

DESCRIPTION

CANADA



CANADA



CANADA



GEPÄCKTRÄGERTASCHE

- **100 % wasserdicht** durch **verschweißte Nähte**
- extrem **strapazierfähiges** Material
- hervorragendes Preis-/Leistungsverhältnis
- stabiler, verstellbarer 3-Punkt **Clip-on**-Halter zur sekundenschnellen (De-)Montage an **Gepäckträgerrohren von 5 - 12 mm**
- zusätzliche **3. Fixierungsmöglichkeit** an der Gepäckträgerstrebe
- Rollverschluss
- **zusätzlicher** Schutz durch **Deckelverschlussklappe**
- mit **Tragegriffen** und Befestigungsringen für Schultergurt (Art. 122700)
- **Verstärkungen** an der Unterseite
- **Rücken- und Kantenschutz**
- mit **Reflexstreifen**
- paarweise im Polybeutel

BICYCLE CARRIER BAG

- **100 % waterproof** through **heat-sealed joints**
- extremely **tough** material
- great value
- firm, adjustable **clip-on** 3-point bracket for (de-)mounting within seconds on **carrier tubes from 5 - 12 mm**
- additional **3. mounting option** on the side bars of the carrier
- roll cover
- **additional** protection by **top cover**
- with **handle** and fixation rings for shoulder strap (art. 122700)
- **reinforcements** at the bottom
- with **rear** and **edge protection**
- with **reflective stripes**
- one pair in PE bag



122722 ›MONTREAL‹
114,90 € / pair
• Volumen ca. **2 x 20 Liter**
• für hinten

›MONTREAL‹
• volume approx. **2 x 20 litres**
• for rear

122725 ›CALGARY‹
89,90 € / pair
• Volumen ca. **2 x 12,5 Liter**
• für vorne und hinten

›CALGARY‹
• volume approx. **2 x 12.5 litres**
• for front and rear



122880 U
29,90 €
GEPÄCKTRÄGERTASCHE
›EDMONTON‹



- **100 % wasserdicht** durch **verschweißte Nähte**
- **strapazierfähiges** Material
- Volumen ca. 16 Liter
- mit Netzaußentasche
- stabiler, verstellbarer **Clip-on**-Halter zur sekundenschnellen (De-)Montage über **Griffzug** an Gepäckträgerrohren von 9 - 16 mm (Ersatzhaken Art. 122889)
- zusätzliche **3. Fixierungsmöglichkeit** an der Gepäckträgerstrebe
- mit Schultergurt
- mit **Reflexmaterial** an den Seiten

CARRIER SINGLE BAG
›EDMONTON‹

- **100 % waterproof** through **heat-sealed joints**
- **tough** material
- volume approx. 16 litres
- with outer net pocket
- firm, adjustable **clip-on** bracket for (de-)mounting within seconds by **pulling the handle** on carrier tubes of 9 - 16 mm (replacement hook art. 122889)
- additional **3. mounting option** at the luggage stay
- with shoulder strap
- with **reflex material** on the sides



122715 U
53,90 €
LENKERTASCHE ›OTTAWA‹



- **100 % wasserdicht** durch **verschweißte Nähte**
- extrem **strapazierfähiges** Material
- stabiler 2-Punkt **Clip-on**-Halter (= Art. 122713) mit einfacher (De-)Montage, passend für Lenker-Ø **22,0 - 31,8 mm**
- absolut verdrehsicher auch bei max. Zuladung von 9 kg
- herausnehmbare Innentasche
- innen zusätzliche Versteifung
- 2 zusätzliche Netzaußentaschen
- mit **Reflexlabel**
- wasserdichte, abnehmbare und beidseitig verwendbare, transparente Kartentasche
- mit Schultergurt
- Volumen ca. 7 Liter

HANDLEBAR BAG ›OTTAWA‹

- **100 % waterproof** through **heat-sealed joints**
- extremely **tough** material
- stable 2-point **clip-on** bracket (= art. 122713) with easy (de-)mounting, suitable for handlebar Ø **22.0 - 31.8 mm**
- anti-twist, also at max. load of 9 kg
- removable inner pocket
- additional internal stiffness
- 2 additional outer net pockets
- with **reflex label**
- waterproof, detachable and double-sided transparent map pocket
- with shoulder strap
- volume approx. 7 litres



122737 Ersatz-/Zweit-Halter, passend für **E-Bike Mitteldisplays**, für Art. 122715, auf M-Wave Eurolochkarte



replacement /second bracket, suitable for **e-bike center display**, for art. 122715, on M-Wave eurohole card



ART.-NR. UVP **BESCHREIBUNG**

DESCRIPTION

122406 SMARTPHONE TASCHE ›BLACK BAY‹

26,90 €



- **100 % wasserdicht**
- Handy durch großes, transparentes Sichtfenster **bedienbar**
- ca. 17 x 8 x 1 cm (L x B x H)
- durch Einlagen passend für alle gängigen Smart- und iPhones
- mit **Universalhalter** für Ø 20 bis 60 mm, passend auch für Garmin (kein original Garmin Ersatzteil)
- **breites Fenster** zur Nutzung des Smartphones als **Actionkamera**
- auf M-Wave Eurolochkarte

SMARTPHONE BAG ›BLACK BAY‹

- **100 % waterproof**
- mobile phone **operable** through large transparent window
- approx. 17 x 8 x 1 cm (L x W x H)
- suitable for all common smartphones and iPhones by inserts
- with **universal bracket** for Ø 20 up to 60 mm, also suitable for Garmin (no original Garmin spare part)
- **wide window** to use the smartphone as **action camera**
- on M-Wave eurohole card



122730 PACKSACK ›HUDSON BAY‹

39,90 €



- **100 % wasserdicht** durch **verschweißte Nähte**
- extrem **strapazierfähiges** Material
- mit **Tragegriffen** und Befestigungsringen für Schultergurt (Art. 122700)
- universell einsetzbar
- mit Bändern oder Gurten auf Seitentaschen fixierbar (auch 2 Stück!)
- mit Rollverschluss und **Sichtfenster**
- mit **Reflexlabel**
- Volumen ca. 28 Liter, ca. 60 cm lang

DUFFLE BAG ›HUDSON BAY‹

- **100 % waterproof** through **heat-sealed joints**
- extremely **tough** material
- with **handles** and fixation rings for shoulder strap (art. 122700)
- universally useable
- can be mounted on the side bags by straps (also 2 duffle bags!)
- with roll cover and **window**
- with **reflex label**
- volume approx. 28 litres, approx. 60 cm



122700 SCHULTERGURT ›BAFFIN BAY‹

7,90 €

- mit **non-slip**-Polster
- für alle unsere wasserdichten Taschen (und viele andere) geeignet

SHOULDER STRAP ›BAFFIN BAY‹

- with **non-slip** pad
- suitable for all of our waterproof bags (and many others)



122739 SCHULTERGURT FÜR E-SCOOTER / FALTRÄDER



7,90 €

- z. B. für Art. 659905/659885/659886, ...
- Breite: 25 mm
- im Polybeutel mit Einleger



SHOULDER STRAP FOR E-SCOOTER / FOLDING BIKES

- e. g. for art. 659905/659885/659886, ...
- width: 25 mm
- in PE bag with sheet



ART.-NR. UVP	BESCHREIBUNG	DESCRIPTION	
122522 U 49,90 €	UNIVERSALTASCHE ›TRAVELLERS BAG‹ <ul style="list-style-type: none"> • 100 % wasserdicht durch verschweißte Nähte • extrem strapazierfähiges Material • mit Reflexaufdruck • ca. 605 x 385 x 550 mm (L x B x H) • Volumen ca. 120 Liter • auch passend für Gepäckanhänger (z. B. Art. 640081) 	UNIVERSAL BAG ›TRAVELLERS BAG‹ <ul style="list-style-type: none"> • 100 % waterproof through heat-sealed joints • extremely tough material • with reflective print • approx. 605 x 385 x 550 mm (L x W x H) • volume approx. 120 litres • also suitable for luggage trailer (e. g. art. 640081) 	 

XL

122380 U 49,90 €	MESSENGER TASCHE ›LOCKERS BAY‹ <ul style="list-style-type: none"> • integrierter, justierbarer Gepäck-trägerhalter (optimiert für linke Seite) mit Reißverschlussabdeckung • große Innentasche mit 2 aufgesetzten Fächern • gepolstertes 15" Notebook Rückenfach mit Klettverschluss • zwei Außentaschen für Trinkflaschen, ... • Volumen ca. 25 Liter • justierbares Gurtband • Reflexstreifen rechts und links 	MESSENGER BAG ›LOCKERS BAY‹ <ul style="list-style-type: none"> • integrated, adjustable mount for rear carriers (optimized for left side) with zipper cover • big compartment with 2 attached pockets • padded 15" notebook compartment with hook and loop fastener • two outer pockets for water bottles, ... • volume approx. 25 litres • adjustable belt • reflective tape on right and left side 	 
------------------------	---	---	--

NIEDERLANDE   **NETHERLANDS** 

121920 U 40,90 €	HARTSCHALEN-LENKERTASCHE ›UTRECHT HC‹ <ul style="list-style-type: none"> • stabile, stoßfeste ABS-Kunststoff-Schalen • hochwertige, seidenmatte und strukturierte Oberfläche • wasserdicht durch verschweißte Doppel-Reißverschlüsse • Stoffauskleidung innen • Maße: 26 x 16 x 19 cm (L x B x H) • Volumen ca. 8 Liter • mit Schultergurt • mit separater Innentasche • abnehmbare, transparente Kartentasche • mit stabilem Clip-on-Halter (= Art. 122709) passend für Ø 22,2 mm bis 31,8 mm 	HARD SHELL-HANDLEBAR BAG ›UTRECHT HC‹ <ul style="list-style-type: none"> • firm, shock-resistant ABS plastic shells • high quality, silk-matt and textured surface • waterproof due to sealed double zippers • fabric inner lining • size: 26 x 16 x 19 cm (L x W x H) • volume approx. 8 litres • with shoulder belt • with separate inner pocket • detachable transparent map pocket • with stable clip-on bracket (= art. 122709) suitable for Ø 22.2 mm up to 31.8 mm 	 
------------------------	--	---	---

122736 19,90 €	Ersatz-/Zweit-Halter, passend für E-Bike-Mitteldisplays , für Art. 431515, 121920, 122882, auf M-Wave Eurolochkarte	replacement / second bracket, suitable for e-bike center displays , for art. 431515, 121920, 122882, on M-Wave eurohole card	
-------------------	--	---	---

E

Bags

ART.-NR. UVP **BESCHREIBUNG**

DESCRIPTION

L

GEPÄCKTRÄGERBOX/TOPCASE
›AMSTERDAM BOX L‹

- **absperribar**, inkl. 2 Schlüssel (Ersatzschloß + Federclip + 2 Schlüssel = Art. 122466)
- aus hochwertigem Kunststoff
- **staub-** und **wasserfest**
- **Volumen ca. 17 Liter**
- Maße: 42 x 26 x 21 cm (L x B x H)
- zur Montage auf dem Gepäckträger
- mit 2 Seitenverschlüssen (Art. 122467)

CARRIER TOP CASE
›AMSTERDAM BOX L‹

- **lockable**, incl. 2 keys (replacement lock + spring clip + 2 keys = art. 122466)
- high quality plastic
- **dust and water resistant**
- **volume approx. 17 litres**
- size: 42 x 26 x 21 cm (L x W x H)
- for fixing on the rear carrier
- with 2 closing parts (art. 122467)



122460 im Einzelkarton
59,90 €

in box

122470 mit Info-Aufkleber im Polybeutel
U
59,90 € Spart Verpackungsvolumen!

with info sticker in PE bag
Saves packaging volume!



GEPÄCKTRÄGERBOX

- Klemmbügel für sicheren Verschluss
- Vorrichtung für **Vorhängeschloss**
- 4 **Spanngurthalter** (Art. 122490)
- aus hochwertigem Kunststoff
- **staub-** und **wasserfest**
- zur Montage auf dem Gepäckträger

CARRIER TOP CASE

- clamp for safe closure
- fixing point for **padlock**
- 4 **tension belt brackets** (art. 122490)
- high quality plastic
- **dust and water resistant**
- for mounting on the rear carrier



122463 ›AMSTERDAM EASY BOX XL‹
U
34,90 €

- Volumen ca. **18 Liter**
- Maße: 42 x 31 x 22 cm (L x B x H)

›AMSTERDAM EASY BOX XL‹
• volume approx. **18 litres**
• size: 42 x 31 x 22 cm (L x W x H)

L-XL

122464 ›AMSTERDAM EASY BOX S‹
U
24,90 €

- Volumen ca. **5 Liter**
- Maße: 27 x 20 x 15 cm (L x B x H)

›AMSTERDAM EASY BOX S‹
• volume approx. **5 litres**
• size: 27 x 20 x 15 cm (L x W x H)



S-M

122465 Ersatzverschluss
2,90 €

replacement closing part



122491 Ersatzstopfen zur Befestigung des Deckels
0,49 €

replacement plugs to mount the top



122492 Ersatzmontage-Set
1,99 €

replacement mounting parts



122479 **LENKERBOX**
U
›AMSTERDAM BOX FRONT‹
27,90 €

- **abschließbar**, inkl. 2 Schlüssel
- zur Montage am Steuersatz (1") und der Vorderradnabe (Adapter für 1 1/8" Steuersatz erhältlich = Art. 431799)
- aus Kunststoff
- **staub-** und **spritzwassergeschützt**
- passend für 26" - 29" Reifen
- Bügel zum leichten Öffnen und zum Schutz des Schließzylinders
- Volumen ca. 17 Liter
- Maße: 23 x 26 x 33 cm

FRONT TOP CASE
›AMSTERDAM BOX FRONT‹

- **lockable**, incl. 2 keys
- for mounting at the head set (1") and the front wheel hub (adapter for 1 1/8" head set available = art. 431799)
- plastic
- **dust and water protected**
- suitable for 26" - 29" tires
- bracket for easy opening and for protection of the lock cylinder
- volume approx. 17 litres
- size: 23 x 26 x 33 cm



ART.-NR. UVP **BESCHREIBUNG**

DESCRIPTION

122310 U **GEPÄCKTRÄGERTASCHE**

68,90 €

›AMSTERDAM TRIPLE‹

ein Modell voller guter Ideen:

- Hauptfächer durch Kunststoffböden **verstärkt**
- Gesamtbreite ca. 65 cm

Seitentaschen:

- Maße: 34 x 17 x 32 cm (L x B x H), Inhalt ca. 34 Liter
- **großes Hauptfach**, durch regengeschützten Reißverschluss von der Seite zugänglich, **kein umständliches Suchen!**
- aufgesetzte **Seitentasche** und **Hecktasche** (als Flaschenhalter verwendbar)
- mit **Reflexstreifen**
- mit **Schnellverschluss** am Gepäckträger zu befestigen und Aussparungen für Gepäckträgerklemme
- mit **Tragegriff** zwischen den Taschen

Toptasche:

- Maße: 34 x 46 x 21 cm, ca. 28 Liter
- mit **Schnellverschluss** an den Seitentaschen befestigt
- bei Bedarf kann eine zweite Toptasche aufgesetzt werden!
- durch langen, regengeschützten Reißverschluss in allen Ecken leicht zugänglich
- mit **aufgesetzter Kleinteiletasche**, **flexiblem Helmhalter** und **Tasche** darunter
- kann als **Rucksack** getragen werden!
- mit **Tragegriff**, **Schultergurt** und **Rücklichthalter**

BICYCLE CARRIER BAG

›AMSTERDAM TRIPLE‹

this model is full of good ideas:

- main compartments **reinforced** by plastic walls
- total width approx. 65 cm

side bags:

- size: 34 x 17 x 32 cm (L x W x H), content approx. 34 litres
- **large main compartment**, accessible from the side by rain protected zipper, **no long-winded searching!**
- attached **side bag** and **rear bag** (usable as bottle cage)
- with **reflective stripes**
- with **QR** for fixing at the carrier and holes for the carrier clamp
- with **handle** between the bags

top bag:

- size: 34 x 46 x 21 cm, approx. 28 litres
- with **QR** fixed to the side bags
- if required a second top bag can be put on top!
- all corners are easily accessible through a long rain protected zipper
- with **attached small parts bag**, **flexible helmet holder** and **pocket** underneath
- can be carried as **backpack!**
- with **handle**, **shoulder strap** and **rear light bracket**

warentest.org
GUT
Note: 1.6
M-WAVE Amsterdam Triple
10/2016



Bags

122317 U **GEPÄCKTRÄGERTASCHE**

49,90 €

›AMSTERDAM DOUBLE L‹

- Material: Kunstleder in **Echtlederoptik**
- Maße: Gesamtbreite ca. 25 cm
Taschen: je 27,5 x 9 x 33,5 cm (L x B x H)
- Volumen ca. 15 Liter
- **große Hauptfächer** mit Metall-schnallen und zusätzlichen **Schnellverschlüssen**
- durch Kunststoffböden **verstärkt**
- Tragegriff zwischen den Taschen
- mit **Aussparungen** oben zum **sicheren Befestigen** auf dem Gepäckträger

BICYCLE CARRIER BAG

›AMSTERDAM DOUBLE L‹

- material: imitation leather in **genuine leather appearance**
- size: total width approx. 25 cm
bags: each 27.5 x 9 x 33.5 cm (L x W x H)
- volume approx. 15 litres
- **large main compartments** with metal buckles and additional **quick fasteners**
- **reinforced** by plastic walls
- handle between the bags
- **slots** on the top for **safe mounting** on the rear carrier



122210 **OBERROHRTASCHE**

12,90 €

›ROTTERDAM TOP XL LE‹

Größe: ca. **18,5 x 9,5 x 8,5 cm**
(L x B x H)

Weitere Artikelinformationen auf Seite 23.

TOP TUBE BAG

›ROTTERDAM TOP XL LE‹

size: approx. **18.5 x 9.5 x 8.5 cm**
(L x W x H)

More product information on page 23.



ART.-NR. UVP	BESCHREIBUNG	DESCRIPTION	
	<p>GEPÄCKTRÄGERTASCHE ›AMSTERDAM DOUBLE‹</p> <ul style="list-style-type: none"> • Maße: Gesamtbreite ca. 50 cm Taschen: je 34 x 17 x 30 cm (L x B x H) • Volumen ca. 30 Liter • große Hauptfächer mit Schnellverschlüssen • durch Kunststoffböden verstärkt • Reflexstreifen und Netz hinten • Tragegriff zwischen den Taschen • mit Aussparungen oben zum sicheren Befestigen auf dem Gepäckträger 	<p>BICYCLE CARRIER BAG ›AMSTERDAM DOUBLE‹</p> <ul style="list-style-type: none"> • size: total width approx. 50 cm bags: each 34 x 17 x 30 cm (L x W x H) • volume approx. 30 litres • large main compartments with QRs • reinforced by plastic walls • reflective stripes and netting on the back • handle between the bags • slots on the top for safe mounting on the rear carrier 	
122315 U	schwarz	black	
122802 U	schwarz/weiß	black/white	
122803 U	schwarz/rot	black/red	
122804 U	schwarz/blau	black/blue	
122805 U 30,90 €	schwarz/grün	black/green	
	<p>122319 REGENHAUBE ›AMSTERDAM PROTECT‹</p> <ul style="list-style-type: none"> • universeller Regenschutz • auch passend für Art. 122310/5, 122802-5, ... • mit M-Wave Banderole 	<p>RAIN COVER ›AMSTERDAM PROTECT‹</p> <ul style="list-style-type: none"> • universal rain protection • also suitable for art. 122310/5, 122802-5, ... • with M-Wave banderole 	
122319 U 11,90 €			
	<p>122304 SEIDENTASCHE UND TROLLEY ›AMSTERDAM TR S‹</p> <p>2 IN 1</p> <p>Diese Tasche kann als Gepäckträger-tasche und Trolley verwendet werden!</p> <ul style="list-style-type: none"> • Maße: ca. 38 x 20 x 45 cm • großes Hauptfach mit Netztasche, aufgesetzte Außentasche und Trinkflaschenhalter • Teleskop-Zugstange • mit 3-Punkt Clip-on-Halter für den Gepäckträger (Haken oben = Art. 122889, Haken unten = Art. 122719) • mit Reflektoren • mit 2 Rollen mit Industriekugellager und 2 Abstellfüßen 	<p>CARRIER SINGLE BAG AND TROLLEY ›AMSTERDAM TR S‹</p> <p>This bag is usable as bicycle bag and as a trolley!</p> <ul style="list-style-type: none"> • size: approx. 38 x 20 x 45 cm • large main compartment with net pocket, attached outer pocket and bottle holder • telescope drawbar • with 3-point clip-on bracket for rear carriers (upper hook = art. 122889, lower hook = art. 122719) • with reflectors • with 2 wheels with sealed bearing and 2 stand-on feet 	
122304 U 59,90 €			
	<p>GEPÄCKTRÄGERTASCHE ›AMSTERDAM SINGLE‹</p> <ul style="list-style-type: none"> • Maße: 38 x 18 x 30 cm (L x B x H) • Volumen ca. 18 Liter • große Tasche mit Schnellverschlüssen • Reflexstreifen und Tragegriff • Schnellbefestigung durch 2 Haken und 1 Spanngummi (Art. 122322) 	<p>BICYCLE CARRIER SINGLE BAG ›AMSTERDAM SINGLE‹</p> <ul style="list-style-type: none"> • size: 38 x 18 x 30 cm (L x W x H) • volumen approx. 18 litres • large bag with QRs • with reflective stripes and handle • quick mounting through 2 hooks and 1 elastic band (art. 122322) 	
122320 U	links	left	
122321 U 24,90 €	rechts	right	

ART.-NR. UVP **BESCHREIBUNG**

DESCRIPTION

- 122745** **GEPÄCKTRÄGER-TASCHEN-ORGANIZER**
 ›AMSTERDAM INSERT‹
 16,90 €
- mit gepolstertem **Laptopfach**
 - Hauptfach durch **flexible Trennwände** aufteilbar
 - für Art. 122315, 122320/1 ...
 - ca. 30 x 14 x 27 cm (L x B x H)
 - mit M-Wave Karte

- ORGANIZER FOR REAR CARRIER BAG**
 ›AMSTERDAM INSERT‹
- with upholstered **laptop compartment**
 - main compartment with **flexible dividers**
 - for art. 122315, 122320/1 ...
 - approx. 30 x 14 x 27 cm (L x W x H)
 - with M-Wave tag



- 122318** **DRYBAG**
 U
 ›AMSTERDAM DRY‹
 9,99 €
- **100 % wasserdicht**
 - universeller Einsatzbereich
 - **Rollverschluss** für universelle Größeneinstellung
 - passend auch als herausnehmbare **Innentasche** für **Gepäckträgertasche** (Art. 122320, ...)
 - Größe ca. 40 x 42 x 16 cm (L x B x H)
 - auf M-Wave Eurolochkarte

- DRYBAG**
 ›AMSTERDAM DRY‹
- **100 % waterproof**
 - universal uses
 - **roll cover** for individual size adjustment
 - also suitable as removable **inner bag** for bicycle **carrier bag** (art. 122320, ...)
 - size approx. 40 x 42 x 16 cm (L x W x H)
 - on M-Wave eurohole card



- 122312** **GEPÄCKTRÄGERTASCHE** ›AMSTERDAM EXP‹
 U
 29,90 €
- großes Hauptfach mit Innentasche
 - **erweiterbar durch zwei große aufklappbare Seitentaschen**
 - Volumen ca. 16 Liter
 - **Haltenetz** oben
 - schnelle und einfache Fixierung durch Klettverschlüsse am Gepäckträger
 - mit **Trinkflaschenhalter**
 - mit Pumpenhalter
 - mit Schulterriemen und Reflektoren

- BICYCLE CARRIER BAG** ›AMSTERDAM EXP‹
- large main compartment with inner bag
 - **expandable through two large side bags**
 - volume approx. 16 litres
 - **attachment net** on top
 - fast and easy velcro attachment to any rear carrier
 - with **bottle holder**
 - with bracket for pump
 - with shoulder straps and reflectors



ART.-NR. BESCHREIBUNG
UVP

DESCRIPTION

122384 LENKERTASCHE

›UTRECHT FOLD‹

34,90 €



- platzsparend **zusammenfaltbar**
- Größe: 37 x 25 x 25 cm (L x B x H)
- Volumen ca. 20 Liter
- mit **Clip-on**-Halter passend für Ø 22,2 bis **31,8 mm**
- stabiler **Rahmen** + feste **Bodenplatte** mit Abstellfüßen
- **2 Tragegurte** zum Zusammenketten
- **Außentasche** mit Reißverschluss
- mit **Regenschutz**
- mit Reflexlogo
- mit M-Wave Banderole

HANDLEBAR BAG

›UTRECHT FOLD‹

- space savingly **foldable**
- size: 37 x 25 x 25 cm (L x W x H)
- volume approx. 20 litres
- with **clip-on** bracket for Ø 22.2 up to **31.8 mm**
- stable **frame** and robust **floor plate** with stand-on feet
- **2 carrying straps** (can be tied up)
- **outer pocket** with zipper
- with **rain shelter**
- with reflective logo
- with M-Wave banderole



122385 LENKERTASCHE

›UTRECHT TRAVEL‹

29,90 €

- mit **Clip-on**-Halter (Art. 431523) passend für Ø **22,2 bis 31,8 mm**
- Volumen ca. 10 Liter
- **2 Zusatztaschen** und **isolierter Flaschenhalter**
- **Klarsichtfenster** für Landkarten
- Trage-/Schulterriemen
- Reflexstreifen

HANDLEBAR BAG

›UTRECHT TRAVEL‹

- with **clip-on** bracket (art. 431523) for Ø **22.2 up to 31.8 mm**
- volume approx. 10 litres
- **2 additional bags** and **insulated bottle holder**
- **window pocket** for maps
- carrying-/shoulder strap
- reflective stripes



122819 LENKERTASCHE

›UTRECHT TRAVEL ECO‹

11,90 €



- Befestigung mit zwei **universell versetzbaren** Klettverschlüssen an **Rollern**, Fahrrädern, ...
- innen mit zusätzlicher Versteifung
- mit Reflexaufdruck
- Größe ca. 22 x 10 x 16 cm (L x B x H)

HANDLEBAR BAG

›UTRECHT TRAVEL ECO‹

- mounting with two **universally displaceable** hook and loop fasteners on **scooters**, bicycles, ...
- additional internal stiffness
- with reflective print
- size approx. 22 x 10 x 16 cm (L x W x H)



122342 LENKERTASCHE

›AMSTERDAM BOTTLE ISO‹

9,90 €



- mit **isolierender Innenschicht**
- **universelle, werkzeuglose** Anbringung am Lenker, Vorbau, Rahmenrohr, ...
- rutschsichere Klettbefestigung
- universelle Einsatzbereiche z. B. für Trinkflaschen, Werkzeuge, ...
- mit Reflexlogo
- mit Kordelzugverschluss

HANDLEBAR BAG

›AMSTERDAM BOTTLE ISO‹

- with **insulating inner layer**
- **universal, toolless** mounting on the handlebar, handle stem, frame tube, ...
- non-slip hook and loop straps
- universal applications e. g. for water bottles, tools, ...
- with reflective logo
- with drawstring fastener



ART.-NR. UVP	BESCHREIBUNG	DESCRIPTION	
<p>122396 U 14,90 €</p> <p>XL</p> <p>360°</p>	<p>SMARTPHONE TASCHЕ ›EINDHOVEN SC 1‹</p> <ul style="list-style-type: none"> • Handy durch großes, transparentes Sichtfenster bedienbar • erschütterungsabsorbierende, weiche Polstereinlage • wasserabweisend • passend für alle gängigen iPhones und Smartphones, z. B. iPhone 12 Pro Max • Größe: ca. 180 x 85 x 30 mm (L x B x H) • drehbarer Clip-on-Halter für Ø 22,0 bis 40 mm • auf M-Wave Eurolochkarte 	<p>SMARTPHONE BAG ›EINDHOVEN SC 1‹</p> <ul style="list-style-type: none"> • mobile phone operable through large, transparent screen • shock absorbing, soft padding • water-repellent • suitable for all popular iPhones and smartphones, e. g. iPhone 12 Pro Max • size: approx. 180 x 85 x 30 mm (L x W x H) • turnable clip-on bracket for Ø 22.0 up to 40 mm • on M-Wave eurohole card 	
<p>122584 U 14,90 €</p> <p>90°</p>	<p>SMARTPHONEHALTER ›BIKE MOUNT AL‹</p> <ul style="list-style-type: none"> • Aluminium • 90° drehbare Lenkerhalterung für Ø 22,2 - 31,8 mm • stufenlos einstellbar von 60 - 95 mm • inkl. Softpads zum Schutz des Smartphones • in M-Wave Eurolochbox 	<p>SMARTPHONE BRACKET ›BIKE MOUNT AL‹</p> <ul style="list-style-type: none"> • aluminium • 90° turnable bracket up to Ø 22.2 - 31.8 mm • infinitely adjustable up to 60 - 95 mm • incl. Softpads to protect the smartphone • in M-Wave eurohole box 	
<p>122580 U 11,90 €</p> <p>360°</p> <p></p>	<p>HALTER FÜR MOBILE ENDGERÄTE ›BIKE MOUNT FLEX‹</p> <ul style="list-style-type: none"> • universelle 360° drehbare Halterung • universell passend für ca. 3,5" - 6,5" Displaygröße • aus elastischem, rutschhemmendem Silikon • schnelle werkzeuglose Montage am Lenker, Vorbau, ... durch Silikonhalter • in M-Wave Eurolochbox 	<p>BRACKET FOR MOBILE DEVICES ›BIKE MOUNT FLEX‹</p> <ul style="list-style-type: none"> • universal 360° turnable bracket • universally suitable for approx. 3.5" - 6.5" display size • made of elastic, non-slip silicone • quick, toolless mounting to the handlebar, handle stem, ... by silicone bracket • in M-Wave eurohole box 	
<p>122405 U 9,90 €</p> <p>360°</p> <p></p>	<p>SMARTPHONE HALTER ›EINDHOVEN GRIP‹</p> <ul style="list-style-type: none"> • erschütterungsabsorbierende, weiche Polstereinlage • werkzeuglos verstellbare Auflagefläche • passend für fast alle gängigen iPhones und Smartphones • Auflagefläche: ca. 110 x 55 x 11 mm bis 126 x 72 x 11 mm (L x B x H) • 360° stufenlos drehbarer Clip-on-Halter für Ø 21 bis 32 mm, werkzeuglose Montage • auf M-Wave Eurolochkarte 	<p>SMARTPHONE BRACKET ›EINDHOVEN GRIP‹</p> <ul style="list-style-type: none"> • shock absorbing, soft padding • toolless adjustable contact area • suitable for almost all iPhones and smartphones • contact area: approx. 110 x 55 x 11 mm up to 126 x 72 x 11 mm (L x W x H) • 360° steplessly turnable clip-on bracket for Ø 21 up to 32 mm, toolless mounting • on M-Wave eurohole card 	
<p>122411 U 9,90 €</p>	<p>HALTER FÜR MOBILE ENDGERÄTE ›EINDHOVEN GRIP EDGE‹</p> <ul style="list-style-type: none"> • aus stabilem ABS-Kunststoff • universelle Größenanpassung (55 x 116 x 12 mm bis 90 x 180 x 12 mm) • passend für viele mobile Endgeräte • 360° drehbar, mit Fixierfunktion • mit Moosgummi-Einlage zur individuellen Anpassung und Stoßabsorption • für Lenkerdurchmesser 22,2 - 31,8 mm • werkzeuglos montierbar • in M-Wave Eurolochbox 	<p>BRACKET FOR MOBILE DEVICES ›EINDHOVEN GRIP EDGE‹</p> <ul style="list-style-type: none"> • made of stable ABS plastic • universal size adjustment (55 x 116 x 12 mm to 90 x 180 x 12 mm) • suitable for many mobile devices • 360° turnable, with fixing function • with foam rubber inlay for individual size adaptation and shock absorption • for handlebar diameter 22.2 - 31.8 mm • toolless mounting • in M-Wave eurohole box 	

ART.-NR. BESCHREIBUNG
UVP

DESCRIPTION

122376 OBERROHRTASCHE
›ROTTERDAM TOP SB‹

16,90 €

XXL

- sichere Befestigung mit 3 Klettverschlüssen
- verstärkter Boden
- erschütterungsabsorbierende, weiche **Polstereinlage**
- wasserabweisendes Material und Reißverschlüsse
- großes Hauptfach, durch Netz unterteilt
- **zwei ausklappbare, erweiterbare Seitentaschen**
- Toptasche mit zwei Innenfächern für **iPhone, Smartphone, GPS-Geräte, ...**
- Touchdisplay durch **wassergeschütztes, transparentes Sichtfenster** bedienbar
- Größe: ca. 18,5 x 11 x 13 cm (L x B x H), zusätzliche Seitentaschen ausgeklappt ca. 12 x 14 x 3 cm

TOP TUBE BAG
›ROTTERDAM TOP SB‹

- secure mounting with 3 hook and loop fasteners
- reinforced bottom
- shock absorbing soft **padding**
- water-repellent material and zipper
- large main compartment, separated inside by a net
- **two foldable, extendable side bags**
- top pocket with two inner pockets for **iPhone, smartphone, GPS device, ...**
- touchpad usable through **water protected, transparent top window pocket**
- size: approx. 18.5 x 11 x 13 cm (L x W x H), additional extended side pockets approx. 12 x 14 x 3 cm



122215 OBERROHRTASCHE
›ROTTERDAM TOP XL SC‹

22,90 €

XL

RESISTANT

- mit **Blendschutz für bessere Sichtbarkeit** des Smartphonedisplays
- sichere Befestigung mit Klettverschlüssen
- Touchdisplay durch **wassergeschütztes, transparentes Sichtfenster** bedienbar
- Reflektoren an den Seiten
- zusätzlich mit universeller Regenschutzhaube
- Größe: ca. 18,5 x 9,5 x 8,5 mm (L x B x H)

TOP TUBE BAG
›ROTTERDAM TOP XL SC‹

- with **glare protection for better visibility** of the smartphone display
- secure mounting with hook and loop fasteners
- touchpad usable through **water protected, transparent top window pocket**
- reflective stripes on the sides
- additionally with universal rain cover
- size: approx. 18.5 x 9.5 x 8.5 mm (L x W x H)



122377 OBERROHRTASCHE
›ROTTERDAM TOP SOUND‹

17,90 €

XL

MUSIC

- mit **integriertem Lautsprecher**
- Anschluss passend für **Smartphones, iPhones, iPods, MP3-Player** (3,5 mm Klinenstecker)
- sichere Befestigung mit 3 Klettverschlüssen
- verstärkter Boden
- erschütterungsabsorbierende, weiche **Polstereinlage**
- wasserabweisendes Material und Reißverschlüsse
- Touchdisplay durch **wassergeschütztes, transparentes Sichtfenster** bedienbar
- passend für **große iPhones und Smartphones**
- Größe: ca. 18 x 9 x 9 cm (L x B x H)

TOP TUBE BAG
›ROTTERDAM TOP SOUND‹

- with **integrated speaker**
- port suitable for **smartphones, iPhones, iPods, MP3 player** (3.5 mm stereo jack)
- secure mounting with 3 hook and loop fasteners
- reinforced bottom
- shock absorbing, soft **padding**
- water-repellent material and zipper
- touchpad usable through **water protected, transparent top window pocket**
- suitable for **bigger iPhones and smartphones**
- size: approx. 18 x 9 x 9 cm (L x W x H)



ART.-NR. BESCHREIBUNG
UVP

DESCRIPTION

XL

**OBERROHRTASCHE
›ROTTERDAM TOP XL‹**

- sichere Befestigung mit 3 Klettverschlüssen
- verstärkter Boden
- erschütterungsabsorbierende, weiche **Polstereinlage**
- wasserabweisendes Material und Reißverschlüsse
- Touchdisplay durch **wassergeschütztes, transparentes Sichtfenster** bedienbar
- Reflektoren an den Seiten
- passend für große **Smartphones**, wie z. B. iPhone X
- Größe: **ca. 18,5 x 9,5 x 8,5 cm** (L x B x H)

**TOP TUBE BAG
›ROTTERDAM TOP XL‹**

- secure mounting with 3 hook and loop fasteners
- reinforced bottom
- shock absorbing, soft **padding**
- water-repellent material and zipper
- touchpad usable through **water protected, transparent top window pocket**
- reflective stripes on the sides
- suitable for bigger **Smartphones** like e. g. iPhone X
- size: **approx. 18.5 x 9.5 x 8.5 cm** (L x W x H)



122372 schwarz

9,90 €

black

122210 • wasserabweisendes Material in **Echtlederoptik**

12,90 €

- Ergänzung zur Gepäckträgertasche Amsterdam Double L (Art. 122317)

• water-repellent material in **genuine leather appearance**

- in addition to bicycle carrier bag Amsterdam Double L (art. 122317)

L

**OBERROHRTASCHE
›ROTTERDAM TOP L‹**

- sichere Befestigung mit 3 Klettverschlüssen
- verstärkter Boden
- erschütterungsabsorbierende, weiche **Polstereinlage**
- wasserabweisendes Material und Reißverschlüsse
- Touchdisplay durch **wassergeschütztes, transparentes Sichtfenster** bedienbar
- Reflektoren an den Seiten
- passend für **Smartphones**
- Größe: ca. 17,5 x 8 x 8,5 cm (L x B x H)

**TOP TUBE BAG
›ROTTERDAM TOP L‹**

- secure mounting with 3 hook and loop fasteners
- reinforced bottom
- shock absorbing, soft **padding**
- water-repellent material and zipper
- touchpad usable through **water protected, transparent top window pocket**
- reflective stripes on the sides
- suitable for **smartphones**
- size: approx. 17.5 x 8 x 8.5 cm (L x W x H)



122375 schwarz

U

black

122552 weiß

U

white

122553 rot

U

red

122554 blau

U

blue

122555 grün

U

green

122556 gelb

U

yellow

122557 orange

U

orange

122558 pink

U

8,90 €

pink

122366 **DREIECKSTASCHE
›ROTTERDAM TRI‹**

6,90 €

- Befestigung mit 3 Klettverschlüssen
- **Reflektoren** an den Seiten
- mit **Polsterung** zum leichten Tragen des Fahrrads

**TRIANGLE BAG
›ROTTERDAM TRI‹**

- fixation with 3 hook and loop fasteners
- **reflective stripes** on the sides
- with **soft padding** for easy carrying the bike



ART.-NR. UVP	BESCHREIBUNG	DESCRIPTION
-----------------	--------------	-------------

122830 **FLASCHENHALTER-TASCHE**
›GRONINGEN BC‹
16,90 €

- inkl. **Aluminium-Adapter** zur Befestigung an den Flaschenhalterösen (unter dem Flaschenhalter)
- wasserdicht**
- mit Innentasche für z. B. Kettenverschlussglieder, ...
- Tasche kann leicht (de-)montiert werden
- Adapter kann auch nur mit Klettbindern (z. B. Art. 340042) genutzt werden
- Größe: ca. 11,0 x 7,5 x 6,5 cm (L x B x H)
- auf M-Wave Eurolochkarte

BOTTLE CAGE BAG
›GRONINGEN BC‹

- incl. **aluminium adapter** for mounting to the bottle cage eyelets (below the bottle cage)
- waterproof**
- with inner bag for e. g. chain links, ...
- bag can easily be (de-)mounted
- bracket can also be used only with hook and loop straps (e. g. art. 340042)
- size: approx. 11.0 x 7.5 x 6.5 cm (L x B x H)
- on M-Wave eurohole card



122831 **SATTELTASCHE**
›AMSTERDAM BOTTLE‹
U
15,90 €

- geräumiges** Hauptfach mit großer Öffnung
- mit **Trinkflaschenhalterfach**
- sichere Befestigung mit vier **universell anpassbaren** Klettverschlüssen
- mit **Rücklichthalterschleife**
- mit **Reflexaufdruck**
- Größe ca. 9,5 x 10 x 27 cm (L x B x H)
- mit M-Wave Anhänger

SADDLE BAG
›AMSTERDAM BOTTLE‹

- spacious** main compartment with large opening
- with **bottle holder pocket**
- secure mounting with four **universally adjustable** hook and loop fasteners
- with **rear light bracket strap**
- with **reflective print**
- size approx. 9.5 x 10 x 27 cm (L x W x H)
- with M-Wave tag



122339 **SATTELTASCHE** ›TILBURG L ILLU‹
22,90 €

- mit **integriertem LED-Ringlicht**, aufladbar über **USB-Kabel** (inkl.)
- einfache, werkzeuglose Montage mit T-Halter für Sattelgestell und Klettverschluss für Sattelstütze
- durch Reißverschluss nach unten **erweiterbar**
- mit **Haltenetz** unten (z. B. für Luftpumpe)
- mit Reflexaufdruck
- Größe: ca. 180 x 115 mm
- Höhe: ca. 105 - 180 mm
- auf M-Wave Eurolochkarte



SADDLE BAG ›TILBURG L ILLU‹

- with **integrated LED light**, rechargeable by **USB cable** (incl.)
- easy, toolless mounting with T-bar for saddle rail and hook and loop strap for seat post
- through zipper **expandable** at the bottom
- with **mesh net** at the bottom (e. g. for pump)
- with reflective print
- size: approx. 180 x 115 mm
- height: approx. 105 - 180 mm
- on M-Wave eurohole card



Ohne deutsches Prüfzeichen - Verkauf und Nutzung im Geltungsbereich der StVZO (Deutschland) unzulässig (Abgabe nur an außerdeutsche Kunden).

ART.-NR. UVP **BESCHREIBUNG**

DESCRIPTION

L

SATTELTASCHE ›TILBURG L‹

- mit Clip-on-Halter (Art. 122299)
- durch Reißverschluss nach unten **erweiterbar**
- mit **Rücklichthalter** und **Klettriemen** unten (z. B. für Luftpumpe)
- mit Reflexaufdruck
- Größe: ca. 180 x 115 mm
- Höhe: ca. 105 - 180 mm

SADDLE BAG ›TILBURG L‹

- with clip-on bracket (art. 122299)
- through zipper **expandable** at the bottom
- with **light bracket** and **hook and loop fasteners** at the bottom (e. g. for pump)
- with reflective print
- size: approx. 180 x 115 mm
- height: approx. 105 - 180 mm



122360 schwarz

U

122482 weiß

U

122483 rot

U

122484 blau

U

122485 grün

U

122488 pink

U

7,90 €

black

white

red

blue

green

pink

122357 SATTELTASCHE ›TILBURG M‹

6,90 €

- Größe: ca. 187 x 60 mm
- Höhe: ca. 95 - 150 mm

M

SADDLE BAG ›TILBURG M‹

- size: approx. 187 x 60 mm
- height: approx. 95 - 150 mm



122356 SATTELTASCHE ›TILBURG S‹

5,50 €

- Befestigung mit Riemen und Klettverschlüssen
- mit **Reflexstreifen** (als **Lichthalter** verwendbar)

S

SADDLE BAG ›TILBURG S‹

- attachment with straps and hook and loop fasteners
- with **reflective stripe** (useable as **light bracket**)



122529 LAUFRADTASCHE ›ROTTERDAM WSB DOUBLE‹

U

54,90 €

2x 29" 4x 700C

- für **2 Laufräder bis 29"**
- Tasche durch Reißverschluss **in zwei Einzeltaschen unterteilbar** (auch einzeln verwendbar)
- Durchmesser 76 cm
- **gepolstert**
- inkl. **Schutzscheiben** für die Naben
- **Innentasche** für Schnellspanner
- mit Tragegriff und **Schultergurt**
- mit beschriftbarem **Namensanhänger**

WHEEL BAG ›ROTTERDAM WSB DOUBLE‹

- for **2 wheels up to 29"**
- zippered bag **dividable into two single bags** (can also be used separately)
- diameter 76 cm
- **padded**
- incl. **protection discs** for the hubs
- **inner pocket** for the QRs
- with handle and **shoulder strap**
- with inscribable **name tag**



LAUFRADTASCHE ›ROTTERDAM WSB‹

- **gepolstert**
- inkl. **2 Schutzscheiben** für die Naben
- **Innentasche** für Schnellspanner
- mit Tragegriff

WHEEL BAG ›ROTTERDAM WSB‹

- **padded**
- incl. **2 protection discs** for the hubs
- **inner pocket** for the QRs
- with handle

122533 Durchmesser 83 cm, für Räder **bis 29"** und besonders breite 26" Laufräder

U

26,90 €

122530 Durchmesser 76 cm, für Räder **bis 28"**

U

21,90 €

diameter 83 cm, for wheels **up to 29"** and extra wide 26" wheels

diameter 76 cm, for wheels **up to 28"**



ART.-NR. UVP **BESCHREIBUNG**

DESCRIPTION

122400 U **ANTRIEBSSCHUTZTASCHE**
 ›ROTTERDAM PROTECT‹
 9,90 €

- optimaler Schutz für die Fahrrad-antriebseinheit im **Auto, Flugzeug, ...**
- **Schutzschutz** auf dem **Fahrrad-träger**
- passend für alle gängigen Kombi-nationen von Kettenradgarnituren, Umwerfern, Kassetten, Schaltwerk, ...
- auf M-Wave Eurolochkarte

DRIVE UNIT PROTECTION BAG
 ›ROTTERDAM PROTECT‹

- optimum drive unit protection during transport in **cars, aeroplanes, ...**
- **dirt protection** during transport on a **car bike carrier**
- fits for all usual combinations of crank-sets, front derailleurs, cassettes, rear derailleurs, ...
- on M-Wave eurohole card



122900 U **PEDALTASCHE**
 ›ROTTERDAM PEDAL P‹
 9,90 €

- **2 Taschen für 1 Paar Pedale**
- aus Neopren
- als **Transporttaschen oder zum Schutz am Rad** verwendbar
- ca. 135 x 145 mm
- 1 Paar auf M-Wave Eurolochkarte

PEDAL BAG
 ›ROTTERDAM PEDAL P‹

- **2 bags for 1 pair of pedals**
- made of neoprene
- suitable as **transport bags or as protection on the bike**
- approx. 135 x 145 mm
- 1 pair on M-Wave eurohole card



122795 U **FAHRRADKOFFER**
 ›ROTTERDAM BIG BOX‹
 499,00 €

- sehr **robuste Ausführung**
- innen **gepolstert**
- **abschließbar**
- mit seitlichen Verschlüssen (Art. 122796)
- mit **2 Laufertaschen**
- mit **Werkzeugtasche**
- Größe: ca. 110/100 x 29 x 79/75 cm (L x B x H)
- mit 2 integrierten/geschützten Rollen hinten (Art. 122797)
- mit 2 lenk-/drehbaren Rollen vorne (Art. 122798)
- inkl. Zieh- und Tragegriff

BIKE CASE
 ›ROTTERDAM BIG BOX‹

- pretty **robust design**
- inner **foam padding**
- **lockable**
- with replacement lock (art. 122796)
- with **2 wheel bags**
- with **tool pocket**
- size approx. 110/100 x 29 x 79/75 cm (L x W x H)
- with 2 integrated/protected pulleys at the back (art. 122797)
- with 2 front pulleys, dirigible and turnable (art. 122798)
- incl. pulling and carrying handle



BIKER SPEZIAL-RUCKSACK
 ›BP BACK‹

- **gepolsterte, atmungsaktive Schultertragegurte und Beckengurt**
- zusätzlicher, verstellbarer Brustgurt
- Tragegestell und anpassbares Rücken-netzteil für **optimal belüfteten Trage-komfort**
- **integrierter Regenüberzug**
- mit **Reflexaufdruck**
- **inkl. abnehmbarem Helmaufbe-wahrungsnetz**
- 1 Hauptfach und 4 kleinere Fächer mit Reißverschluss
- integriertes, **isoliertes** Fach für **Trinkblase**
- zusätzlich 2 äußere Fächer und 1 großes Innenfach
- mit Rücklichthalter
- Volumen ca. 15 Liter
- ca. 46 x 28 x 12 cm

BIKER SPECIAL BACKPACK
 ›BP BACK‹

- **padded, breathable shoulder straps and waist belt**
- additional, adjustable chest belt
- carrying structure and adaptable back net for **optimally ventilated wearing comfort**
- **integrated rain cover**
- with **reflective print**
- **incl. detachable helmet storage net**
- 1 main compartment and 4 smaller pockets with zipper
- integrated **insulated** compartment for **water bag**
- additionally 2 outer compartments and 1 big inner compartment
- with rear light strap
- volume approx. 15 litres
- approx. 46 x 28 x 12 cm



122634 U schwarz / blau

black / blue

122635 neongelb, **besonders gute Sichtbarkeit durch leuchtende Farbe und Reflexaufdruck**
 46,90 €

neon yellow, **very good visibility due to bright colour and reflective print**



ART.-NR. BESCHREIBUNG
UVP

DESCRIPTION

122536 FALTRUCKSACK ›DELUXE‹

24,90 €

FOLD

287 g

- nur 287 g
- zusammengefaltet nur 16 x 11 x 8 cm (L x B x H), aufgefaltet ca. 49 x 28 x 13 cm
- Volumen ca. 20 Liter
- **3 Fächer** mit Reißverschluss: Haupt-, Front- und Innenfach (das gleichzeitig als Tasche für den gefalteten Rucksack dient)
- **Helmfach** mit drei justierbaren Klippverschluss-Gurten
- **2 elastische Außennetztaschen** (für Trinkflaschen, ...)
- leicht gepolstertes Rückenteil
- justierbare, leicht gepolsterte Schultergurte mit 2 x 3 Organizer-Laschen
- zusätzlicher **Brustgurt** für perfekten Sitz
- mit Befestigungsclips für Rahmen, Sattelgestell, ...

FOLDABLE BACKPACK ›DELUXE‹

- only 287 g
- folded size only 16 x 11 x 8 cm (L x W x H), unfolded approx. 49 x 28 x 13 cm
- volume approx. 20 litres
- **3 compartments** with zipper: main, front and inner compartment (which is also the storage bag for the folded backpack)
- **helmet case** with 3 adjustable clip belts
- **2 elastic outer net pockets** (for bottles, ...)
- slightly padded back part
- adjustable, slightly padded shoulder straps with 2 x 3 organizer clips
- additional **chest belt** for perfect fit
- with fixing clips for frames, saddle rails, ...



122352 KORB + TASCHENÜBERZUG ›MAASTRICHT PROTECT‹

11,90 €

- **universeller** Regenschutz für **Körbe**, Rucksäcke bis ca. 25 Liter, Vorderradtaschen, Gepäcktaschen, ...
- mit **2 Haltegurten** auf der Rückseite
- **3M Scotchlite® Reflexstreifen** auf drei Seiten
- mit aufgesetzter Netztasche
- auf M-Wave Eurolochkarte

BASKET + BAG COVER ›MAASTRICHT PROTECT‹

- **universal** rain protection for **baskets**, back bags up to approx. 25 litres, front bags, rear bags, ...
- with **2 fixation straps** on back
- **3M Scotchlite® reflective stripes** on three sides
- with fitted net pocket
- on M-Wave eurohole card



122500 TRINKRUCKSACK ›MAASTRICHT H2O‹

39,90 €

- **2-Liter-Wasserblase** von **SOURCE** mit **antibakterieller Innenbeschichtung** (Art. 122515)
- **große Reinigungsöffnung**
- Trinkschlauch mit **auswechselbarem, drehbarem Clip-on-Mundstück** (Art. 122516)
- **isoliertes** Fach
- mit Reflexstreifen
- mit **2 Zusatztaschen**
- Volumen: ca. 6 Liter

WATER BACKPACK ›MAASTRICHT H2O‹

- **2-litres-water bag** from **SOURCE** with **antimicrobial protection inside** (art. 122515)
- **big opening for cleaning**
- drinking tube with **exchangeable, turnable clip-on bite valve** (Art. 122516)
- **insulated** compartment
- with reflective stripes
- with **2 additional pockets**
- volume: approx. 6 litres



122503 Rucksack ohne Wasserblase und Trinkschlauch

19,90 €

backpack without water bag and drinking tube

122515 WASSERBLASE ›SOURCE‹

23,90 €

- 2-Liter-Wasserblase mit **antibakterieller Innenbeschichtung**
- 2.000 % **glattere Oberfläche** als herkömmliche TPU-Folien beugt Schimmelbildung vor
- **große Öffnung** für schnelles und leichtes Befüllen und Reinigen
- **geschmacksneutral** und **frei von BPA und Phthalaten**
- Trinkschlauch mit **antibakterieller Innenbeschichtung** und **auswechselbarem Silikon-Mundstück** (Art. 122516)
- passend für Trinkrucksäcke, z. B. Art. 122503, 122634

WATER BAG ›SOURCE‹

- 2-litres-water bag with **antimicrobial protection inside**
- 2,000 % **smoother surface** than conventional TPU foils prevents mould formation
- **big opening** for fast and easy filling and cleaning
- **tasteless and free from BPA and phthalates**
- drinking tube with **antimicrobial protection inside** and **exchangeable silicone bite valve** (art. 122516)
- suitable for water backpacks, e. g. art. 122503, 122634



122381 OBERARMTASCHE ›MAASTRICHT ARM‹

9,90 €

- **universell passend** für viele **Smartphones** (170 x 120 mm)
- drei **Kopfhörerausgänge**
- mit elastischem Klettverschluss
- transparentes Sichtfenster
- auf M-Wave Eurolochkarte

UPPER ARM BAG ›MAASTRICHT ARM‹

- **universally suitable** for many **smartphones** (170 x 120 mm)
- **3 exits for ear-phones**
- with elastic hook and loop fastener
- transparent window
- on M-Wave eurohole card



ART.-NR. BESCHREIBUNG
UVP

DESCRIPTION

137940 SATTELDECKE ›URBAN‹

6,90 €



- 20 mm **Schaumstoffeinlage**
- schwarz mit **reflektierenden Seiten**
- durch Zugkordel für alle Größen anpassbar
- auf M-Wave Eurolochkarte

SADDLE COVER ›URBAN‹

- 20 mm **foam pad**
- black with **reflective sideparts**
- adjustable by drawstring for all sizes
- on M-Wave eurohole card



GEL-SATTELDECKEN ›ANATOMIC‹

- sehr bequeme Satteldecken
- **anatomisch** geformte Geleinlage
- mit Spannschnur
- auf M-Wave Eurolochkarte

137600 für MTB-, Touring- und Rennradsättel

U
9,90 €

137601 breite Ausführung

U
12,90 €

GEL SADDLE COVERS ›ANATOMIC‹

- very comfortable saddle covers
- **anatomic** formed GEL-inlay
- with tensioning cord
- on M-Wave eurohole card

for MTB, touring and racing saddles

big version



SATTELDECKE ›FASHION‹

- Universalgröße
- 10 mm **Schaumstoffeinlage, eingenäht**
- mit **Zugkordel**
- auf M-Wave Eurolochkarte

137920 ›Sunflower‹
U

137921 ›Newspaper‹
U

137922 ›Ladybird‹
U

137930 ›Smile‹
5,90 € Weitere Motive auf Anfrage.

SADDLE COVER ›FASHION‹

- universal size
- 10 mm **foam pad, sewn-in**
- with **cord and stopper**
- on M-Wave eurohole card

›Sunflower‹

›Newspaper‹

›Ladybird‹

›Smile‹

More motives on request.



Saddle Covers



M-WAVE

www.m-wave-bike.com

ART.-NR. **BESCHREIBUNG**
UVP

DESCRIPTION

220766 AKKULAMPE
›APOLLON ULTRA 900‹

99,90 €

900 LUMEN

- 2  **XM-L2 U2 Hochleistungs-LEDs**
- **Aluminium / Kunststoffgehäuse**
- Leistung max. 12 Watt
- Lichtleistung **900 Lumen**
- 4 Funktionen: 3x Dauerlicht (Fern-/Abblendlicht und besonders breiter Lichtkegel) und Stroboskop
- externer Lithium-Ionen Akku (8,4 V / 8800 mAh)
- Laufzeit: 3,5 - 7 Stunden
- im wasserdichten Batteriegehäuse mit Klettverschluss
- inkl. 8,4 V / 220 V Ladegerät mit **Überladungsschutz**
- Universalhalter für Lenker, ... mit Gummibandbefestigung für Ø 22,2 - 35 mm
- Stirn-/Helmhalter mit Kopfgurten
- in hochwertiger M-Wave Box

RECHARGEABLE LAMP
›APOLLON ULTRA 900‹

- 2  **XM-L2 U2 high power LEDs**
- **aluminium / plastic housing**
- max. power 12 Watt
- **900 Lumen** brightness
- 4 functions: 3x steady light (high/ lower beam and extra wide cone of light) and strobe light
- external Lithium Ion rechargeable battery (8.4 V / 8800 mAh)
- running time: 3.5 - 7 hours
- in waterproof batterie case with hook and loop fastener
- incl. 8.4 V / 220 V battery charger with **overvoltage protection**
- universal bracket for handlebar, ... with rubber band fixation for Ø 22.2 - 35 mm
- forehead/helmet bracket with head bands
- in high quality M-Wave box



Ohne deutsches Prüfzeichen - Verkauf und Nutzung im Geltungsbereich der StVZO (Deutschland) unzulässig (Abgabe nur an außerdeutsche Kunden).

220405 AKKULAMPE
›APOLLON K 1.1 USB‹

34,90 €

25 LUX



SILICONE



- 1 weiße  **LED**
- mit **deutschem Prüfzeichen**
- **wasserfestes Silikongehäuse**
- Helligkeit **25 Lux**
- aufladbar über **USB-Kabel** (inkl.)
- nur ca. 86 g
- **Lithium-Polymer-Schnelllade-Akku** (3,7 V / 850 mAh)
- Laufzeit: ca. 3 Stunden
- mit Batterie- und Ladezustandsanzeige
- integrierter **universeller Silikonhalter**
- **schnelle werkzeuglose** Montage, für Ø 22,2 - 32 mm
- auf M-Wave Eurolochkarte

RECHARGEABLE LAMP
›APOLLON K 1.1 USB‹

- 1 white  **LED**
- with **German approval number**
- **water resistant silicone housing**
- brightness **25 Lux**
- rechargeable by **USB cable** (incl.)
- only approx. 86 g
- **Lithium Polymer quick charge battery** (3.7 V / 850 mAh)
- running time: approx. 3 hours
- with battery level and charge control indicator
- integrated **universal silicone bracket**
- **quick toolless** mounting, for Ø 22.2 - 32 mm
- on M-Wave eurohole card



220404 AKKULAMPE
›APOLLON K 30 USB‹

19,90 €

30/15 LUX



- 1 weiße **LED**
- 2 Funktionen: maximale Beleuchtung, Energiesparmodus
- Helligkeit **30 / 15 Lux**
- mit **deutschem Prüfzeichen**
- 360° drehbarer Halter für Ø 19 - 35 mm (Art. 223559)
- schnelle werkzeuglose Montage
- mit Batterie- und Ladezustandsanzeige
- nur ca. 51 g
- **Lithium-Akku** (3,7 V / 1.200 mAh)
- Laufzeit: ca. 3,5 - 7 Stunden
- aufladbar über **USB-Kabel** (inkl.)
- in M-Wave Blisterverpackung

RECHARGEABLE LAMP
›APOLLON K 30 USB‹

- 1 white **LED**
- 2 functions: maximum illumination, power saving mode
- brightness **30 / 15 Lux**
- with **German approval number**
- 360° turnable bracket for Ø 19 - 35 mm (art. 223559)
- quick toolless mounting
- with battery level and charge control indicator
- only approx. 51 g
- **Lithium rechargeable battery** (3.7 V / 1,200 mAh)
- running time: approx. 3.5 - 7 hours
- rechargeable by **USB cable** (incl.)
- in M-Wave blister packaging



ART.-NR. BESCHREIBUNG
UVP

DESCRIPTION

220421 U AKKULAMPE
›APOLLON 20 USB‹

17,90 €



- 1 weiße **1 Watt** LED mit SST (**Soft Start Technology**)
- hochwertiges **Aluminiumgehäuse**
- 3 Funktionen (2x Dauer- und 1x Blinklicht)
- **Helligkeit bis zu 20 Lux, 95 Lumen**
- mit Batterie- und Ladezustandsanzeige
- Lithium-Akku (3,7 V / 600 mAh)
- Laufzeit: ca. 2 - 5 Stunden
- aufladbar über **USB-Kabel** (inkl.)
- Halter für Ø 22,2 - 35 mm (Art. 223551)
- werkzeuglose Montage
- nur ca. **54 g**
- auf M-Wave Eurolochkarte

RECHARGEABLE LAMP
›APOLLON 20 USB‹

- 1 white **1 Watt** LED with SST (**Soft Start Technology**)
- high quality **aluminium** housing
- 3 functions (2x steady and 1x flashing light)
- **brightness levels up to 20 Lux, 95 Lumen**
- with battery level and charge control indicator
- Lithium rechargeable battery (3.7 V / 600 mAh)
- running time: approx. 2 - 5 hours
- rechargeable by **USB cable** (incl.)
- bracket for Ø 22.2 - 35 mm (art. 223551)
- toolless mounting
- only approx. **54 g**
- on M-Wave eurohole card



Ohne deutsches Prüfzeichen - Verkauf und Nutzung im Geltungsbereich der StVZO (Deutschland) unzulässig (Abgabe nur an außerdeutsche Kunden).

220887 U BATTERIELAMPE
›APOLLON A 1.2 3 WATT‹

14,90 €



- 1 weiße, **ultrahelle 3 Watt LED**
- **Aluminiumgehäuse**
- 2 Funktionen (Dauer- und Blinklicht)
- Laufzeit: ca. 2 Stunden
- mit Dreh-Clip-on-Halter von Ø 22,2 - 31,8 mm (Art. 223541), werkzeuglose Montage
- auch als Minitaschenlampe verwendbar
- inkl. Batterien (4x AAA)
- in M-Wave Kunststoffbox

BATTERY LAMP
›APOLLON A 1.2 3 WATT‹

- 1 white, **ultra bright 3 Watt LED**
- **aluminium** housing
- 2 functions (steady and flashing light)
- running time: approx. 2 hours
- with twist clip-on bracket from Ø 22.2 - 31.8 mm (art. 223541), toolless mounting
- can also be used as a mini torch
- incl. batteries (4x AAA)
- in M-Wave plastic box



Ohne deutsches Prüfzeichen - Verkauf und Nutzung im Geltungsbereich der StVZO (Deutschland) unzulässig (Abgabe nur an außerdeutsche Kunden).

220998 BATTERIELAMPE
›APOLLON A 1.3 3 WATT‹

12,90 €



- 1 weiße **CREE** **3 Watt Hochleistungs-LED**
- **Zoomfunktion: Ausleuchtungsbereich bis zu 2000-fach stufenlos verstellbar**
- 3 Funktionen (2x Dauer- und 1x Blinklicht)
- hochwertiges, gedichtetes **Aluminiumgehäuse**
- universeller QR-Clip-on-Halter Ø 20 - 28,6 mm (Art. 223514), werkzeuglose Montage
- auch als Minitaschenlampe verwendbar
- inkl. Batterien (3x AAA)
- in M-Wave Blisterverpackung

BATTERY LAMP
›APOLLON A 1.3 3 WATT‹

- 1 white **CREE** **3 Watt high power LED**
- **zoom function: illumination area seamlessly adjustable up to 2000 times**
- 3 functions (2x steady and 1x flashing light)
- high quality sealed **aluminium housing**
- universal QR clip-on bracket Ø 20 - 28.6 mm (art. 223514), toolless mounting
- also usable as mini torch
- incl. batteries (3x AAA)
- in M-Wave blister packaging



Ohne deutsches Prüfzeichen - Verkauf und Nutzung im Geltungsbereich der StVZO (Deutschland) unzulässig (Abgabe nur an außerdeutsche Kunden).

220447 U BATTERIELAMPE
›APOLLON K 1.2‹

11,90 €



- 1 weiße **Hochleistungs-LED**
- **Klarglasscheinwerfer**
- mit **deutschem Prüfzeichen**
- 2 Helligkeitsstufen: **30/15 Lux**
- Laufzeit: ca. 2 - 4 Stunden
- nur 49 g (ohne Batterien)
- mit Batteriezustandsanzeige
- mit QR-Clip-on-Halter (Art. 223515) von Ø **22,2 - 31,8 mm**, werkzeuglose Montage
- inkl. Batterien (4x AAA)
- in M-Wave Blisterverpackung

BATTERY LAMP
›APOLLON K 1.2‹

- 1 white **super bright LED**
- **clear lense beam**
- with **German approval number**
- 2 brightness levels: **30/15 Lux**
- running time: approx. 2 - 4 hours
- only 49 g (w/o batteries)
- with battery level indicator
- with QR clip-on bracket (art. 223515) from Ø **22.2 - 31.8 mm**, toolless mounting
- incl. batteries (4x AAA)
- in M-Wave blister packaging



ART.-NR. **BESCHREIBUNG**
UVP

DESCRIPTION

220401 BATTERIELAMPE ›APOLLON 2‹

BATTERY LAMP ›APOLLON 2‹

10,90 €



- 1 weiße **1 Watt LED**
- **60 Lumen**
- 3 Funktionen (1x Dauer- und 2x Blinklicht)
- Laufzeit: ca. 10 - 20 Stunden
- mit QR-Clip-On Halter bis Ø 31,8 mm
- werkzeuglose Montage
- inkl. Batterien (3x AAA)
- auch als Minitaschenlampe verwendbar
- in M-Wave Blisterverpackung

- 1 white **1 Watt LED**
- **60 Lumen**
- 3 functions (1x steady and 2x flashing light)
- running time: approx. 10 - 20 hours
- with QR clip-on bracket up to Ø 31.8 mm
- toolless mounting
- incl. batteries (3x AAA)
- also useable as mini torch
- in M-Wave blister packaging



Ohne deutsches Prüfzeichen - Verkauf und Nutzung im Geltungsbereich der StVZO (Deutschland) unzulässig (Abgabe nur an außerdeutsche Kunden).

220957 BATTERIELAMPE ›APOLLON 5.3‹

BATTERY LAMP ›APOLLON 5.3‹

11,90 €



- **5 weiße Hochleistungs-LEDs**
- 3 Funktionen (1x Dauer- und 2x Blinklicht)
- extrem lange Leuchtdauer
- fokussierte Ausleuchtung durch **optische Linsen**
- mit QR-Clip-on-Halter von Ø 22,2 - 31,8 mm, werkzeuglose Montage
- auch als Minitaschenlampe verwendbar
- inkl. Batterien (3x AAA)
- in M-Wave Blisterverpackung

- **5 white super bright LEDs**
- 3 functions (1x steady and 2x flashing light)
- extremely long run time
- focused illumination by **optical lenses**
- with QR clip-on bracket from Ø 22.2 - 31.8 mm, toolless mounting
- also useable as mini torch
- incl. batteries (3x AAA)
- in M-Wave blister packaging



Ohne deutsches Prüfzeichen - Verkauf und Nutzung im Geltungsbereich der StVZO (Deutschland) unzulässig (Abgabe nur an außerdeutsche Kunden).

220941 BATTERIELAMPE ›APOLLON A 9.1‹

BATTERY LAMP ›APOLLON A 9.1‹

8,90 €

- **9 weiße LEDs**
- hochwertiges, **gedichtetes Aluminiumgehäuse**
- mit Universal-Clip-on-Halter Ø 22,2 - 28 mm (Art. 223533)
- auch als **Minitaschenlampe** verwendbar
- inkl. Batterien (3x AAA)
- in M-Wave Blisterverpackung

- **9 white LEDs**
- high-quality, **sealed aluminium housing**
- with universal clip-on bracket Ø 22.2 - 28 mm (art. 223533)
- also usable as **mini torch**
- incl. batteries (3x AAA)
- in M-Wave blister packaging



Ohne deutsches Prüfzeichen - Verkauf und Nutzung im Geltungsbereich der StVZO (Deutschland) unzulässig (Abgabe nur an außerdeutsche Kunden).

220942 BATTERIELAMPE ›APOLLON 4.3‹

BATTERY LAMP ›APOLLON 4.3‹

8,90 €



- **4 weiße LEDs**
- 3 Funktionen (1x Dauer- und 2x Blinklicht)
- Universalhalter passend für Ø 22,2 bis 31,8 mm
- mit Ersatzgummi für Halter
- werkzeuglose Montage
- auch als **Minitaschenlampe** verwendbar
- inkl. Batterien (3x AAA)
- in M-Wave Blisterverpackung

- **4 white LEDs**
- 3 functions (1x steady and 2x flashing light)
- universal bracket suitable for Ø 22.2 up to 31.8 mm
- with replacement rubber for bracket
- toolless mounting
- also usable as **mini torch**
- incl. batteries (3x AAA)
- in M-Wave blister packaging



Ohne deutsches Prüfzeichen - Verkauf und Nutzung im Geltungsbereich der StVZO (Deutschland) unzulässig (Abgabe nur an außerdeutsche Kunden).

ART.-NR. BESCHREIBUNG
UVP

DESCRIPTION

220545
U
19,90 €

AKKULAMPE
›APOLLON DUAL 3.8 USB‹

RECHARGEABLE LAMP
›APOLLON DUAL 3.8 USB‹



- **Front- und Rücklicht in einem: 2 weiße LEDs** vorne und **eine super-helle rote LED** hinten
- maximale Lichtleistung vorne: 60 Lumen
- **8 Funktionen** (5x Blinklicht und 3x Helligkeitsstufen der weißen LEDs)
- mit Memoryfunktion
- Lithium-Polymer Akku (3,7 V / 240 mAh)
- Laufzeit: ca. 1,5 - 6 Stunden
- nur **18 g**
- aufladbar über **USB-Kabel** (inkl.)
- Batterie- und Ladezustandsanzeige
- auch um **90° gedreht** montierbar
- universeller Klettverschlusshalter für Helm, Lenker, Rahmen, Sattelstütze, ...
- werkzeuglose Montage
- in M-Wave Blisterverpackung

- **front and rear light in one: 2 white LEDs** at the front and **one super bright red LED** at the back
- maximum light output at the front: 60 lumen
- **8 functions** (5x flashing light and 3x brightness levels of the white LEDs)
- with memory function
- rechargeable Lithium Polymer battery (3.7 V / 240 mAh)
- running time: approx. 1.5 - 6 hours
- only **18 g**
- rechargeable by **USB cable** (incl.)
- battery level and charge control indicator
- also mountable **turned by 90°**
- universal hook and loop fastener for helmet, handlebar, frame, seat tube, ...
- toolless mounting
- in M-Wave blister packaging



Ohne deutsches Prüfzeichen - Verkauf und Nutzung im Geltungsbereich der StVZO (Deutschland) unzulässig (Abgabe nur an außerdeutsche Kunden).

220572
U
17,90 €

AKKURÜCKLICHT
›HELIOS K 1.1 USB‹

RECHARGEABLE REAR LIGHT
›HELIOS K 1.1 USB‹



- 1 rote **Hochleistungs-LED**
- mit **deutschem Prüfzeichen**
- schwarzes **Silikongehäuse**
- aufladbar über **USB-Kabel** (inkl.)
- integrierter **universeller Silikonhalter**
- **schnelle werkzeuglose** Montage
- mit Lithium-Ionen Akku (3,7 V / 160 mAh)
- mit Batterie- und Ladezustandsanzeige
- in M-Wave Blisterverpackung

- 1 red **high power LED**
- with **German approval number**
- black **silicone housing**
- rechargeable by **USB cable** (incl.)
- integrated **universal silicone bracket**
- **quick toolless** mounting
- with rechargeable Lithium Ion battery (3.7 V / 160 mAh)
- with battery level and charge control indicator
- in M-Wave blister packaging



220559
U
13,90 €

AKKURÜCKLICHT
›HELIOS K 1.1 USB SL‹

RECHARGEABLE REAR LIGHT
›HELIOS K 1.1 USB SL‹



- 1 rote **LED**
- mit **deutschem Prüfzeichen**
- Halter für Ø 19 - 35 mm (Art. 223561)
- Winkel des Halters einstellbar
- **240°** Abstrahlwinkel
- **klein aber fein**, nur **11 g** (ohne Halter)
- schnelle werkzeuglose Montage
- mit Batterie- und Ladezustandsanzeige
- aufladbar über **USB-Kabel** (inkl.)
- **Lithium-Polymer Akku** (3,7 V / 240 mAh)
- Laufzeit: ca. 4 Stunden
- in M-Wave Blisterverpackung

- 1 red **LED**
- with **German approval number**
- bracket for Ø 19 - 35 mm (art. 223561)
- adjustable angle of the bracket
- **240°** illumination angle
- **small but fine**, only **11 g** (without bracket)
- quick toolless mounting
- with battery level and charge control indicator
- rechargeable by **USB cable** (incl.)
- **rechargeable Lithium Polymer battery** (3.7 V / 240 mAh)
- running time: approx. 4 hours
- in M-Wave blister packaging



221037
U
9,90 €

BATTERIEBLINKLICHT
›HELIOS 2.3‹

BATTERY FLASHING LIGHT
›HELIOS 2.3‹



- **2x 0,5-Watt ultrahelle Superflash-LEDs**
- 3 Funktionen (1x Dauer- und 2x Blinklicht)
- mit Universalschelle für Sattelstützen von Ø 25,4 - 31,8 mm
- **90° drehbar**
- werkzeuglose Montage
- inkl. Batterien (2x AAA)
- in M-Wave Blisterverpackung

- **2x 0.5-Watt superbright flash LEDs**
- 3 functions (1x steady and 2x flashing light)
- with universal bracket for seat posts from Ø 25.4 - 31.8 mm
- **90° turnable**
- toolless mounting
- incl. batteries (2x AAA)
- in M-Wave blister packaging



Ohne deutsches Prüfzeichen - Verkauf und Nutzung im Geltungsbereich der StVZO (Deutschland) unzulässig (Abgabe nur an außerdeutsche Kunden).

ART.-NR. UVP **BESCHREIBUNG**

DESCRIPTION

- 220513**
U
9,90 €
- BATTERIEBREMSLICHT ›HELIOS BRAKE‹**
- 1 superhelle rote LED
 - **leuchtet beim Zug des Bremshebels auf**
 - 3 Funktionen (Blink-, Dauer- und Bremslicht)
 - für **Rennrad- und V-Bremse** geeignet
 - **werkzeuglose Montage**
 - inkl. Batterie (CR 2032)
 - in M-Wave Blisterverpackung



- BATTERY BRAKE LIGHT ›HELIOS BRAKE‹**
- 1 super bright red LED
 - **lights up by the pull of the brake lever**
 - 3 functions (flashing, steady and brake light)
 - suitable for **road and V-brake**
 - **toolless mounting**
 - incl. battery (CR 2032)
 - in M-Wave blister packaging

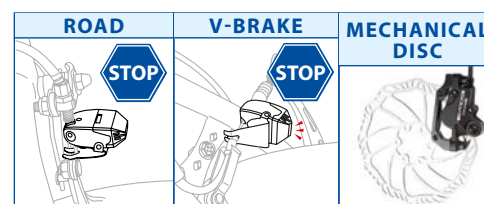

Ohne deutsches Prüfzeichen - Verkauf und Nutzung im Geltungsbereich der StVZO (Deutschland) unzulässig (Abgabe nur an außerdeutsche Kunden).

- 221041**
U
7,90 €
- BATTERIEBLINKLICHT ›HELIOS 3.2 S‹**
- **3 rote LEDs, davon eine 0,5 Watt Hochleistungs-LED mit Superflash-Funktion** für exzellente Sichtbarkeit
 - 2 Funktionen (Dauer- und Blinklicht)
 - universeller, **90° drehbarer und winkelverstellbarer** Halter für Sattelstütze von Ø 25,4 - 31,8 mm
 - werkzeuglose Montage
 - inkl. Batterien (2x AAA)
 - in M-Wave Blisterverpackung



- BATTERY FLASHING LIGHT ›HELIOS 3.2 S‹**
- **3 red LEDs, thereof one 0.5 Watt high power LED with superflash function** for excellent visibility
 - 2 functions (steady and flashing light)
 - universal, **90° turnable and angle adjustable** bracket for seat post from Ø 25.4 - 31.8 mm
 - toolless mounting
 - incl. batteries (2x AAA)
 - in M-Wave blister packaging



Ohne deutsches Prüfzeichen - Verkauf und Nutzung im Geltungsbereich der StVZO (Deutschland) unzulässig (Abgabe nur an außerdeutsche Kunden).

- 220569**
U
6,90 €
- BATTERIERÜCKLICHT ›HELIOS K 1.1‹**
- 1 rote **Hochleistungs-SMD-LED**
 - Universalhalter passend für Ø 25,4 - 31,8 mm (Art. 223516)
 - mit **deutschem Prüfzeichen**
 - Laufzeit: bis zu 9,5 Stunden
 - inkl. Batterien (2x AAA)
 - mit Batteriezustandsanzeige
 - in M-Wave Blisterverpackung

- BATTERY REAR LIGHT ›HELIOS K 1.1‹**
- 1 red **high power SMD LED**
 - universal bracket suitable for Ø 25.4 - 31.8 mm (art. 223516)
 - with **German approval number**
 - running time: up to 9.5 hours
 - incl. batteries (2x AAA)
 - with battery level indicator
 - in M-Wave blister packaging



- 221055**
U
5,90 €
- BATTERIERÜCKLICHT ›HELIOS K 1.1 RS‹**
- innovatives Design
 - mit **deutschem Prüfzeichen**
 - nur **30 g**
 - **230° sichtbar** durch transparentes Gehäuse
 - universeller Gummihalter Ø 22,2 - 30 mm (Art. 223506)
 - **werkzeuglose Montage an der Sattelstütze, Sitzrohr- oder Kettenstrebe** möglich
 - inkl. Batterien (2x CR 2032)
 - auf M-Wave Eurolochkarte



- BATTERY REAR LIGHT ›HELIOS K 1.1 RS‹**
- innovative design
 - with **German approval number**
 - only **30 g**
 - **230° visible** because of transparent housing
 - universal rubber bracket Ø 22.2 - 30 mm (art. 223506)
 - **toolless mounting at the seat post, seat tube or chain stay** possible
 - incl. batteries (2x CR 2032)
 - on M-Wave eurohole card



ART.-NR. UVP **BESCHREIBUNG**

DESCRIPTION

221040 BATTERIEBLINKLICHT

›ATLAS L.R‹

4,90 €

- **3 rote LEDs**
- 3 Funktionen (1x Dauer- und 2x Blinklicht)
- mit Halter (Art. 220824) für Sattelstütze und Gürtelclip
- inkl. **Batterien** (2x AAA)
- in M-Wave Blisterverpackung

BATTERY FLASHING LIGHT

›ATLAS L.R‹

- **3 red LEDs**
- 3 functions (1x steady and 2x flashing light)
- with bracket (art. 220824) for seat post and belt clip
- incl. **batteries** (2x AAA)
- in M-Wave blister packaging



Ohne deutsches Prüfzeichen - Verkauf und Nutzung im Geltungsbereich der StVZO (Deutschland) unzulässig (Abgabe nur an außerdeutsche Kunden).

221034 BATTERIEBLINKLICHT

›HELIOS 5.3‹

4,90 €



- **5 ultrahelle SMD-LEDs**
- 3 Funktionen (1x Dauer- und 2x Blinklicht)
- mit winkelverstellbarem Clip-on Gummibandhalter passend für Ø 25,4 - 31,8 mm
- Licht **90° drehbar**
- inkl. Batterien (2x AAA)
- in M-Wave Blisterverpackung

BATTERY FLASHING LIGHT

›HELIOS 5.3‹

- **5 superbright SMD LEDs**
- 3 functions (1x steady and 2x flashing light)
- with angle-adjustable clip-on rubber bracket suitable for Ø 25.4 - 31.8 mm
- light **90° turnable**
- incl. batteries (2x AAA)
- in M-Wave blister packaging



Ohne deutsches Prüfzeichen - Verkauf und Nutzung im Geltungsbereich der StVZO (Deutschland) unzulässig (Abgabe nur an außerdeutsche Kunden).

220627 AKKU-BLINKLICHT

›APOLLON MINI A USB‹

10,90 €



- **hochwertiges Aluminiumgehäuse**
- 1 rote **0,5 Watt LED**
- 10 Lumen
- aufladbar über **USB-Kabel** (inkl.)
- Lithium-Akku (3,7 V / 220 mAh)
- mit Batteriezustands- und Ladezustandsanzeige
- bis zu **30 Stunden Laufzeit**
- 3 Funktionen (1x Dauer- und 2x Blinklicht)
- nur **26 g**
- universelle, werkzeuglose Montage durch elastisches Gummiband Ø 22,2 - 31,8 mm
- in M-Wave Blisterverpackung

RECHARGEABLE FLASHING LIGHT

›APOLLON MINI A USB‹

- **high quality aluminium housing**
- 1 red **0.5 Watt LED**
- 10 Lumen
- rechargeable by **USB cable** (incl.)
- rechargeable Lithium battery (3.7 V / 220 mAh)
- with battery level and charge control indicator
- up to **30 hours run time**
- 3 functions (1x steady and 2x flashing light)
- only **26 g**
- universal, toolless mounting with elastic rubber strap Ø 22.2 - 31.8 mm
- in M-Wave blister packaging



220628 wie Art. 220627, Set für vorne und hinten

20,90 €

like art. 220627, set for front and rear



Ohne deutsches Prüfzeichen - Verkauf und Nutzung im Geltungsbereich der StVZO (Deutschland) unzulässig (Abgabe nur an außerdeutsche Kunden).

Lamps & Brackets

ART.-NR. BESCHREIBUNG
UVP

DESCRIPTION

220565 BATTERIEBLINKLICHT-SET
›APOLLON MINI A‹

U
10,90 €



- hochwertiges Aluminiumgehäuse
- Set mit **1 weißen** und **1 roten LED**
- **240° Abstrahlwinkel**
- 3 Funktionen (1x Dauer- und 2x Blinklicht)
- nur **25 g/Stück**
- universelle, werkzeuglose Montage durch elastische Gummibänder Ø 22,2 - 31,8 mm
- inkl. Batterien (je 2x CR 2032)
- in M-Wave Blisterverpackung

BATTERY FLASHING LIGHT SET
›APOLLON MINI A‹

- **high quality aluminium** housing
- set with **1 white** and **1 red LED**
- **240° radiation angle**
- 3 functions (1x steady and 2x flashing light)
- only **25 g/piece**
- universal, toolless mounting with elastic rubber straps Ø 22.2 - 31.8 mm
- incl. batteries (2x CR 2032 each)
- in M-Wave blister packaging



Ohne deutsches Prüfzeichen - Verkauf und Nutzung im Geltungsbereich der StVZO (Deutschland) unzulässig (Abgabe nur an außerdeutsche Kunden).

220608 BATTERIEBLINKLICHT-SET
›HUNTER‹

U
9,90 €



- innovatives **Design**
- Set mit je **2 weißen** bzw. **2 roten LEDs**
- 3 Funktionen (1x Dauer- und 2x Blinklicht)
- universelle Befestigung durch elastische Silikonbänder
- werkzeuglose Montage
- inkl. Batterien (je 2x CR 2032)
- in M-Wave Blisterverpackung

BATTERY FLASHING LIGHT SET
›HUNTER‹

- innovative **design**
- set with **2 white** and **2 red LEDs**
- 3 functions (1x steady and 2x flashing light)
- universal fixation with elastic silicone straps
- toolless mounting
- incl. batteries (each 2x CR 2032)
- in M-Wave blister packaging



Ohne deutsches Prüfzeichen - Verkauf und Nutzung im Geltungsbereich der StVZO (Deutschland) unzulässig (Abgabe nur an außerdeutsche Kunden).

SILICONE BATTERIEBLINKLICHT
›COBRA‹



- innovatives Design
- 2 Funktionen (Dauer- und Blinklicht)
- nur **18 g**
- universeller Gummihalter
- **werkzeuglose** Schnellmontage
- inkl. Schraubendreher für Batterie-wechsel
- inkl. Batterien (2x CR 2025)
- farbig sortiert
- in M-Wave Blisterverpackung

BATTERY FLASHING LIGHT
›COBRA‹

- innovative design
- 2 functions (steady and flashing light)
- only **18 g**
- universal rubber bracket
- **toolless** quick mounting
- incl. screw driver for changing batteries
- incl. batteries (2x CR 2025)
- assorted colours
- in M-Wave blister packaging



220582 weiße LED
U

white LED



220583 rote LED
U
5,90 €

red LED



220584 BATTERIEBLINKLICHT-SET
›COBRA‹

U
9,90 €

- Set mit je einer **weißen** (Art. 220582) und **roten** (Art. 220583) **LED**
- farbig sortiert
- in M-Wave Blisterverpackung

BATTERY FLASHING LIGHT SET
›COBRA‹

- set with one **white** (art. 220582) and one **red** (art. 220583) **LED**
- assorted colours
- in M-Wave blister packaging



Ohne deutsches Prüfzeichen - Verkauf und Nutzung im Geltungsbereich der StVZO (Deutschland) unzulässig (Abgabe nur an außerdeutsche Kunden).

ART.-NR. UVP **BESCHREIBUNG**

DESCRIPTION

220599 BATTERIEBLINKLICHT-SET

›COBRA II‹

9,90 €



- Set mit je **2 weißen** bzw. **2 roten LEDs**
- 3 Funktionen (1x Dauer- und 2x Blinklicht)
- nur 24 g
- universelle Befestigung durch elastische Silikonbänder
- werkzeuglose Montage
- inkl. Batterien (je 2x CR 2032)
- in M-Wave Blisterverpackung

BATTERY FLASHING LIGHT SET

›COBRA II‹

- set with **2 white** and **2 red LEDs**
- 3 functions (1x steady and 2x flashing light)
- only 24 g
- universal fixation with elastic silicone straps
- toolless mounting
- incl. batteries (each 2x CR 2032)
- in M-Wave blister packaging



Ohne deutsches Prüfzeichen - Verkauf und Nutzung im Geltungsbereich der StVZO (Deutschland) unzulässig (Abgabe nur an außerdeutsche Kunden).

221063 BATTERIEBLINKLICHT-SET

›COBRA III‹

6,90 €



- Set mit je **2 weißen** bzw. **2 roten LEDs**
- 2 Funktionen (Dauer- und Blinklicht)
- nur **19 g**
- universeller Gummihalter Ø 22,2 - 31,8 mm
- werkzeuglose Montage
- inkl. Batterien (je 2x CR 2032)
- in M-Wave Blisterverpackung

BATTERY FLASHING LIGHT SET

›COBRA III‹

- set with **2 white** and **2 red LEDs**
- 2 functions (steady and flashing light)
- only **19 g**
- universal rubber bracket Ø 22.2 - 31.8 mm
- toolless mounting
- incl. batteries (each 2x CR 2032)
- in M-Wave blister packaging



Ohne deutsches Prüfzeichen - Verkauf und Nutzung im Geltungsbereich der StVZO (Deutschland) unzulässig (Abgabe nur an außerdeutsche Kunden).



BATTERIEBLINKLICHT-SET

›COBRA IV‹

- Set mit je **2 weißen** und **2 roten LEDs**
- 3 Funktionen (1x Dauer- und 2x Blinklicht)
- nur 24 g pro Licht
- universeller Silikonhalter
- werkzeuglose Montage
- inkl. Batterien (je 2x CR 2032)
- in M-Wave Blisterverpackung

BATTERY FLASHING LIGHT SET

›COBRA IV‹

- set with **2 white** and **2 red LEDs**
- 3 functions (1x steady and 2x flashing light)
- only 24 g per lamp
- universal silicone bracket
- toolless mounting
- incl. batteries (each 2x CR 2032)
- in M-Wave blister packaging



220630 schwarz

U

black

220632 weiß

U

white

220633 rot

U

red

220634 blau

U

blue

220635 grün

U

green

220636 gelb

U

yellow

220637 orange

U

orange

220638 pink

U

pink

220639 lila

U

6,90 €

purple



Ohne deutsches Prüfzeichen - Verkauf und Nutzung im Geltungsbereich der StVZO (Deutschland) unzulässig (Abgabe nur an außerdeutsche Kunden).

ART.-NR. UVP **BESCHREIBUNG**

DESCRIPTION

221058 AKKULAMPEN-SET
›ATLAS K10 USB‹

49,90 €

25 LUX



SILICONE



- mit **deutschem Prüfzeichen**
- **wasserdichtes Silikongehäuse**
- integrierter **universeller Silikonhalter**
- **schnelle** werkzeuglose Montage
- mit Batterie- und Ladezustandsanzeige
- aufladbar über **USB-Kabel** (inkl.)
- auf M-Wave Eurolochkarte

Frontlicht (Art. 220405):

- 1 weiße **Cree LED**
- Helligkeit **25 Lux**
- nur ca. 86 g
- Lithium-Polymer Schnellladeakku
- Halter für Ø 22,2 - 32 mm

Rücklicht (Art. 220572):

- 1 rote **Hochleistungs-LED**
- **Lithium-Akku**

RECHARGEABLE LAMP SET
›ATLAS K10 USB‹

- with **German approval number**
- **water resistant silicone housing**
- integrated **universal silicone bracket**
- **quick** toolless mounting
- with battery level and charge control indicator
- rechargeable by **USB cable** (incl.)
- on M-Wave eurohole card

front light (art. 220405):

- 1 white **Cree LED**
- brightness **25 Lux**
- only approx. 86 g
- Lithium Polymer quick charge battery
- bracket for Ø 22.2 - 32 mm

rear light (art. 220572):

- 1 red **high power LED**
- **Lithium rechargeable battery**



221090 AKKULAMPEN-SET
›ATLAS K 11 USB‹

29,99 €

28/15 LUX



- mit **deutschem Prüfzeichen**
- schnelle werkzeuglose Montage
- mit **Batterie- und Ladezustandsanzeige**
- aufladbar über **USB-Kabel** (inkl.)
- **Lithium-Akku**
- in M-Wave Blisterverpackung

Frontlicht:

- 1 weiße **Osram LED**
- **2 Funktionen** (2x Dauerlicht)
- Helligkeit **28 / 15 Lux**
- bis zu **70 Lumen**
- Halter für Ø 22,2 - 31,8 mm (Art. 223553)
- nur ca. **55 g**

Rücklicht:

- 3 rote **LEDs**
- nur ca. **23 g**
- Halter für Ø 25,4 - 33 mm (Art. 223554)

RECHARGEABLE LAMP SET
›ATLAS K 11 USB‹

- with **German approval number**
- quick toolless mounting
- with **battery level and charge control indicator**
- rechargeable by **USB cable** (incl.)
- **rechargeable Lithium battery**
- in M-Wave blister packaging

front light:

- 1 white **Osram LED**
- **2 functions** (2x steady light)
- brightness **28 / 15 Lux**
- up to **70 Lumen**
- bracket for Ø 22.2 - 31.8 mm (art. 223553)
- only approx. **55 g**

rear light:

- 3 red **LEDs**
- only approx. **23 g**
- bracket for Ø 25.4 - 33 mm (art. 223554)



221091 AKKULAMPEN-SET
›ATLAS K 15 USB‹

29,90 €



30/15 LUX

- mit **deutschem Prüfzeichen**
- schnelle werkzeuglose Montage
- mit Batterie- und Ladezustandsanzeige
- aufladbar über **USB-Kabel** (inkl.)
- in M-Wave Blisterverpackung

Frontlicht Art. 220404:

- 1 weiße **LED**
- 2 Funktionen (maximale Beleuchtung, Energiesparmodus)
- Helligkeit **30 / 15 Lux**
- 360° drehbarer Halter für Ø 19 - 35 mm (Art. 223559)
- nur ca. 51 g
- **Lithium-Akku** (3,7 V / 1.200 mAh)

Rücklicht Art. 220559:

- 1 rote **LED**
- Halter für Ø 19 - 35 mm (Art. 223561)
- **240 Grad** Abstrahlwinkel
- **Lithium-Polymer Akku**

RECHARGEABLE LAMP SET
›ATLAS K 15 USB‹

- with **German approval number**
- quick toolless mounting
- with battery level and charge control indicator
- rechargeable by **USB cable** (incl.)
- in M-Wave blister packaging

front light art. 220404:

- 1 white **LED**
- 2 functions (maximum illumination, power saving mode)
- brightness **30 / 15 Lux**
- 360° turnable bracket for Ø 19 - 35 mm (Art. 223559)
- only approx. 51 g
- **rechargeable Lithium battery** (3.7 V / 1,200 mAh)

rear light art. 220559:

- 1 red **LED**
- bracket for Ø 19 - 35 mm (Art. 223561)
- **240 degrees** radiation angle
- **rechargeable Lithium Polymer battery**



ART.-NR. UVP **BESCHREIBUNG**

DESCRIPTION

221092 U **AKKULAMPEN-SET**
›ATLAS 20 USB‹

29,90 €



- mit Batterie- und Ladezustandsanzeige
- aufladbar über **USB-Kabel** (inkl.)
- Lithium-Akku
- auf M-Wave Eurolochkarte

1
WATT

- Frontlicht** Art. 220421:
- 1 weiße **1 Watt** LED mit SST (**S**oft **S**tart **T**echnology)
 - hochwertiges **Aluminium**gehäuse
 - **3 Funktionen:** 2x Dauer- und 1x Blinklicht
 - Helligkeit bis zu 20 Lux, 95 Lumen
 - Halter für Ø 22,2 - 35 mm (Art. 223551)
 - nur ca. **54 g**

0,5
WATT

- Rücklicht:**
- 1x **0,5 Watt** LED mit rotem Glas
 - 3 Funktionen: 2x Dauer- und 1x Blinklicht
 - schnelle werkzeuglose Montage
 - winkelverstellbarer Halter für Ø 25,4 - 35 mm
 - nur ca. **17 g**

RECHARGEABLE LAMP SET
›ATLAS 20 USB‹

- with battery level and charge control indicator
- rechargeable by **USB cable** (incl.)
- rechargeable Lithium battery
- on M-Wave eurohole card

- front light** art. 220421:
- 1 white **1 Watt** LED with SST (**S**oft **S**tart **T**echnology)
 - high quality **aluminium** housing
 - **3 functions:** 2x steady and 1x flashing light
 - brightness levels up to 20 Lux, 95 Lumen
 - bracket for Ø 22.2 - 35 mm (art. 223551)
 - only approx. **54 g**

- rear light:**
- 1x **0.5 Watt** LED with red glas
 - 3 functions: 2x steady and 1x flashing light
 - quick toolless mounting
 - angle-adjustable bracket for Ø 25.4 - 35 mm
 - only approx. **17 g**



Ohne deutsches Prüfzeichen - Verkauf und Nutzung im Geltungsbereich der StVZO (Deutschland) unzulässig (Abgabe nur an außerdeutsche Kunden).

221064 U **BATTERIELEUCHTEN-SET**
›ATLAS 22‹

19,90 €



- inkl. Batterien (6x AAA)
- in M-Wave Eurolochkarte

3
WATT

- Frontlicht** (Art. 220887):
- **Aluminium**gehäuse
 - weiße, **ultrahelle 3 Watt LED**
 - 2 Funktionen: Dauer- und Blinklicht
 - mit Dreh-Clip-on-Halter für Ø 22,2 - 31,8 mm (Art. 223541), werkzeuglose Montage

- Blinklicht** (Art. 221040):
- 3 rote LEDs
 - 3 Funktionen: 1x Dauer- und 2x Blinklicht
 - mit Halter (Art. 220824) für Sattelstütze und Gürtelclip

BATTERY LAMP SET
›ATLAS 22‹

- incl. batteries (6x AAA)
- in M-Wave eurohole card

- front light** (art. 220887):
- **aluminium** housing
 - white, **ultra bright 3 Watt LED**
 - 2 functions: steady and flashing light
 - with twist clip-on bracket for Ø 22.2 - 31.8 mm (art. 223541), toolless mounting

- flashing light** (art. 221040):
- 3 red LEDs
 - 3 functions: 1x steady and 2x flashing light
 - with bracket (art. 220824) for seat post and belt clip



Ohne deutsches Prüfzeichen - Verkauf und Nutzung im Geltungsbereich der StVZO (Deutschland) unzulässig (Abgabe nur an außerdeutsche Kunden).

ART.-NR. BESCHREIBUNG
UVP

DESCRIPTION

221057 BATTERIELEUCHTEN-SET

16,90 €



- mit **deutschem Prüfzeichen**
- mit Batteriezustandsanzeige
- inkl. Batterien (4x AAA / 2x AAA)
- in M-Wave Blisterverpackung

30/15

LUX

- Frontlicht** (Art. 220447):
- 1 weiße **Hochleistungs-LED**
 - **Klarglasscheinwerfer** mit **Freiform-reflektor**
 - 2 Helligkeitsstufen: **30/15 Lux**
 - nur **49 g** (ohne Batterien)
 - mit QR-Clip-on-Halter für **Ø 22,2 - 31,8 mm** (Art. 223515), werkzeuglose Montage

- Rücklicht** (Art. 220569):
- 1 rote **Hochleistungs-SMD-LED**
 - Universalhalter passend für **Ø 25,4 - 31,8 mm** (Art. 223516)

BATTERY LAMP SET

›ATLAS K50‹

- with **German approval number**
- with battery level indicator
- incl. batteries (4x AAA / 2x AAA)
- in M-Wave blister packaging

- front light** (art. 220447):
- 1 white **high power/performance LED**
 - **clear lens beam** with **special reflector**
 - 2 brightness levels: **30/15 Lux**
 - only **49 g** (w/o batteries)
 - with QR clip-on bracket for **Ø 22.2 - 31.8 mm** (art. 223515), toolless mounting

- rear light** (art. 220569):
- 1 red **high power SMD LED**
 - universal bracket for **Ø 25.4 - 31.8 mm** (art. 223516)



220423 STIRNLAMPE

19,90 €



- ›HELIOS RUNNER 140‹**
- **Cree XP-G2 R5 LED, 5 Watt**
 - leichtes, wasserdichtes (IPX5) Kunststoffgehäuse
 - 4 Funktionen: 3x Helligkeitsstufen und zusätzliche **SOS-Funktion**
 - **Sensorfunktion:** an/aus über Handbewegung zu steuern
 - justierbarer und flexibler Kopfgurt mit **Anti-Rutsch-Silikon-Beschichtung**
 - Helligkeit bis zu 140 Lumen
 - Abstrahlwinkel bis zu 60° einstellbar
 - Lithium-Polymer Akku, 1.200 mAh
 - Laufzeit: bis zu 15 Stunden
 - inkl. Micro **USB**-Kabel
 - mit Batterie- und Ladezustandsanzeige
 - nur 52 g (ohne Kopfgurt)
 - in M-Wave Eurolochbox

HEAD LIGHT

›HELIOS RUNNER 140‹

- **Cree XP-G2 R5 LED, 5 Watt**
- light and waterproof (IPX5) plastic housing
- 4 functions: 3x brightness levels and additional **SOS function**
- **sensor function:** control on/off by hand movement
- adjustable and flexible head belt with **non-slip silicone coating**
- brightness up to 140 Lumen
- adjustable beam angle up to 60°
- rechargeable lithium polymer battery, 1,200 mAh
- running time: up to 15 hours
- incl. Micro **USB** cable
- with battery level and charge control indicator
- only 52 g (without head strap)
- in M-Wave eurohole box

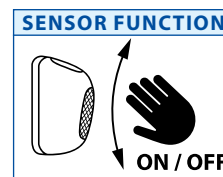

Ohne deutsches Prüfzeichen - Verkauf und Nutzung im Geltungsbereich der StVZO (Deutschland) unzulässig (Abgabe nur an außerdeutsche Kunden).



223570 KONVERTER ›POWER BASE‹

6,90 €



- von Wechselstrom- auf **USB**-Anschluss
- **Eingangsleistung:** 100-240 V Wechselstrom, 0,15 A, 50/60 Hz
- **Ausgangsleistung:** 5 V Gleichstrom, max. 1 A
- Schutzklasse II, IP 20
- mit **Lade-Kontrollleuchte**
- auf M-Wave Eurolochkarte

CONVERTER ›POWER BASE‹

- AC to **USB**
- **Input:** AC 100-240 V, 0.15 A, 50/60 Hz
- **Output:** DC 5 V, max. 1 A
- protection class II, IP 20
- with **battery indicator light**
- on M-Wave eurohole card



ART.-NR. UVP **BESCHREIBUNG**

DESCRIPTION

220753 U **LENKERCOCKPIT**
›COCKPIT PLUS‹

12,90 €

- passend für Lenker mit **Ø 22,2 - 31,8 mm**
- Rohrdurchmesser 22,2 mm
- Breite 90 mm
- **verschiebbar**
- auf M-Wave Eurolochkarte

HANDLEBAR ORGANIZER
›COCKPIT PLUS‹

- for handlebar with **Ø 22.2 - 31.8 mm**
- tube diameter 22.2 mm
- width 90 mm
- **slidable**
- on M-Wave eurohole card



220972 U **GABELHALTER**
›FORK COCKPIT‹

4,90 €

- passend für **Gabelbrücke** und **Gabelkopf**
- runde Aufnahme mit Ø 22,2 mm
- **ausziehbar**
- universell geeignet für fast alle Batterielampen, Computer, ...
- auf M-Wave Eurolochkarte

FORK BRACKET
›FORK COCKPIT‹

- suitable for **fork arch** and **crown**
- round fixing point with Ø 22.2 mm
- **extendable**
- universally suitable for almost all battery lamps, computers, ...
- on M-Wave eurohole card



223560 U **SCHNELLSPANNER-**
LAMPENHALTER

9,90 €

- zur Befestigung **am Schnellspanner** (5 mm, nicht inklusive)
- **CNC-gefrästes Aluminium**
- Länge: 57 mm, Ø 26 mm
- Gewicht: 19 g
- auf M-Wave Eurolochkarte

QUICK RELEASE
LAMP HOLDER

- for mounting **at QR** (5 mm, not included)
- **CNC machined aluminium**
- length: 57 mm, Ø 26 mm
- weight: 19 g
- on M-Wave eurohole card



M-WAVE
YOUR WORLD OF CYCLING

ART.-NR. BESCHREIBUNG
UVP

DESCRIPTION

230982 KETTENSCHLOSS ›C 10.10 ID‹

87,90 €



- **Öffnung mit eingespeichertem Fingerabdruck** oder optional mit persönlichem Sicherheitscode
- **20 verschiedene Fingerabdrücke speicherbar**
- 10 x 10 x 900 mm
- Lithium-Ionen Akku (3,7 V - 300 mAh) aufladbar über mitgeliefertes USB-C Kabel
- **bis zu 6 Monate Standby-Zeit**
- mit Textilüberzug
- mit M-Wave Bänderole

CHAIN LOCK ›C 10.10 ID‹

- **opening with preset fingerprint** or optionally with individual security code
- **20 different fingerprints can be saved**
- 10 x 10 x 900 mm
- Lithium Ion battery (3.7 V - 300 mAh) rechargeable by included USB-C cable
- **up to 6 months standby time**
- with textile cover
- with M-Wave banderole



230981 BÜGELSCHLOSS ›B 307 ID‹

76,90 €



- **Öffnung mit eingespeichertem Fingerabdruck** oder optional über 2 CNC gefräste Notfallschlüssel
- **20 verschiedene Fingerabdrücke speicherbar**
- Lithium-Ionen Akku (3,7 V - 300 mAh) aufladbar über mitgeliefertes USB-C Kabel
- **bis zu 6 Monate Standby-Zeit**
- hochwertiger Schlossüberzug mit angenehmer Haptik
- universeller Clip-on-Halter für Sattelstützen, Rahmenrohre, ...
- mit M-Wave Bänderole

SHACKLE LOCK ›B 307 ID‹

- **opening with preset fingerprint** or optionally with 2 CNC machined keys
- **20 different fingerprints can be saved**
- Lithium Ion battery (3.7 V - 300 mAh) rechargeable by included USB-C cable
- **up to 6 months standby time**
- high-quality lock coating with a pleasant feel
- universal clip-on bracket for seat posts, frame tubes, ...
- with M-Wave banderole



Locks

ART.-NR. BESCHREIBUNG
UVP

DESCRIPTION

HIGH SECURITY

HIGH SECURITY

HIGH SECURITY

SEIEN SIE SICH SICHER,
BEI DIESER SICHERHEIT!

Unsere **hochwertigen Schlösser** punkten sowohl mit **extra** starken und gehärteten Stahlkernen, als auch mit **top verarbeiteten Schließköpfen**. Hier schreckt nicht nur die Optik jeden Dieb ab!

BE SURE, WITH THIS SAFETY!

Our **high-class locks** score with **extra** strong and hardened steel cores as well as **highly processed lock heads**. Not only the visual appearance will frighten off every potential thief!



230950 KETTENSCHLOSS ›C 10.9-360‹

54,90 €

10 x 10 x 900



- 10 x 10 x 900 mm
- **besonders widerstandsfähig** durch **gehärtete quadratische Kettenglieder** und **robusten Schließzylinder**
- viele verschiedene **computer-designte** Schlüsselvarianten
- **360° drehbarer Verschlusskopf**
- mit Staubschutzkappe
- mit Textilüberzug
- mit M-Wave Banderole

CHAIN LOCK ›C 10.9-360‹

- 10 x 10 x 900 mm
- **very robust** because of **hardened square chain links** and **robust cylinder lock**
- many different **computer-designed** key variants
- **360° turnable lock head**
- with dust cap
- with textile cover
- with M-Wave banderole



230920 SPIRALKABELSCHLOSS
›S 20.18‹

39,90 €

20 x 1.800

- Ø 20 x 1.800 mm
- **extra dickes**, geflochtenes Kabel
- **360° drehbarer Verschlusskopf**
- dunkel-transparenter Überzug
- viele verschiedene **computer-designte** Schlüsselvarianten
- universeller Clip-on-Halter für Sattelstütze und Rahmenrohr Ø 22,2 - 43 mm
- mit Staubschutzkappe
- auf M-Wave Eurolochkarte

SPIRAL CABLE LOCK
›S 20.18‹

- Ø 20 x 1,800 mm
- **extra thick**, twisted cable
- **360° turnable lock head**
- dark transparent cover
- many different **computer-designed** key variants
- universal clip-on bracket for seat post and frame tube Ø 22.2 - 43 mm
- with dust cap
- on M-Wave eurohole card



230910 SPIRALKABELSCHLOSS
›DS 20.18‹

39,90 €

20 x 1.800



- Ø 20 x 1.800 mm
- **extra dickes**, geflochtenes Kabel
- dunkel-transparenter Überzug
- **verstellbarer, persönlicher Sicherheitscode** aus 5 Zahlen
- auf M-Wave Eurolochkarte

SPIRAL CABLE LOCK
›DS 20.18‹

- Ø 20 x 1,800 mm
- **extra thick**, twisted cable
- dark transparent cover
- **changeable, individual security code** with 5 digits
- on M-Wave eurohole card



REFLEX 

REFLEX 

REFLEX 

230961 SPIRALKABELSCHLOSS
›S 10.18 ILLU‹

8,90 €



10 x 1.800

- Ø 10 x 1.800 mm
- mit **Reflexstreifen**
- dunkel-transparenter Überzug
- Clip-on-Halter (Art. 233849) für Sattelstütze und Rahmenrohr, beidseitig einführbar
- mit **Staubschutzkappe**
- **automatische Verriegelung**
- auf M-Wave Eurolochkarte

SPIRAL CABLE LOCK
›S 10.18 ILLU‹

- Ø 10 x 1,800 mm
- with **reflective stripe**
- dark transparent cover
- clip-on bracket (art. 233849) for seat post and frame tube, clip-on possibility from both sides
- with **dust cap**
- **automatic locking**
- on M-Wave eurohole card



ART.-NR. BESCHREIBUNG
UVP

DESCRIPTION

REFLEX



REFLEX



REFLEX

230962 SPIRALKABELSCHLOSS

›DS 10.18 ILLU‹

U
8,90 €



10 x
1.800

- Ø 10 x 1.800 mm
- mit **Reflexstreifen**
- dunkel-transparenter Überzug
- **verstellbarer**, persönlicher Sicherheitscode
- Clip-on-Halter (Art. 233849) für Sattelstütze oder Rahmenrohr, beidseitig einführbar
- auf M-Wave Eurolochkarte

SPIRAL CABLE LOCK

›DS 10.18 ILLU‹

- Ø 10 x 1,800 mm
- with **reflective stripe**
- dark transparent cover
- **changeable**, individual security code
- clip-on bracket (art. 233849) for seat post or frame tube, clip-on possibility from both sides
- on M-Wave eurohole card



230960 KABELSCHLOSS ›C 15.8 ILLU‹

U
7,90 €



15 x
1.800

- Ø 15 x 800 mm
- geflochtenes Kabel
- mit **Reflexstreifen**
- dunkel-transparenter Überzug
- **automatische Verriegelung**
- auf M-Wave Eurolochkarte

CABLE LOCK ›C 15.8 ILLU‹

- Ø 15 x 800 mm
- twisted cable
- with **reflective stripe**
- dark transparent cover
- **automatic locking**
- on M-Wave eurohole card



230963 KETTENSCHLOSS ›C 6.8,5 ILLU‹

U
14,90 €



6 x
850

- Ø 6 x 850 mm
- Textilüberzug mit **Reflexstreifen**
- **automatische Verriegelung**
- mit Staubschutzkappe
- **computer-designte** Schlüssel
- mit M-Wave Banderole

CHAIN LOCK ›C 6.8,5 ILLU‹

- Ø 6 x 850 mm
- textile cover with **reflective stripe**
- **automatic locking**
- with dust cap
- **computer-designed** keys
- with M-Wave banderole



230964 ZAHLEN-KETTENSCHLOSS ›D 6.8,5 ILLU‹

U
14,90 €



6 x
850



- Ø 6 x 850 mm
- Textilüberzug mit **Reflexstreifen**
- mit **5 Zahlenscheiben**
- mit **verstellbarem**, persönlichem Sicherheitscode
- mit M-Wave Banderole

COMBINATION CHAIN LOCK ›D 6.8,5 ILLU‹

- Ø 6 x 850 mm
- textile cover with **reflective stripe**
- with **5 digits**
- with **changeable**, individual security codes
- with M-Wave banderole



ART.-NR. BESCHREIBUNG
UVP

DESCRIPTION

HEXAGONALSCHLÖSSER



HEXAGONAL LOCKS

233853 SPIRALKABELSCHLOSS

›DS 12.18‹

12,90 €



12x
1.800

- Ø 12 x 1.800 mm
- mattschwarz transparenter, **hexagonaler** Überzug
- **verstellbarer, persönlicher Sicherheitscode**
- universeller Clip-on-Halter für Sattelstütze, Rahmenrohr und für Sattelmuldenbolzen
- auf M-Wave Eurolockkarte

SPIRAL CABLE LOCK

›DS 12.18‹

- Ø 12 x 1,800 mm
- matt black transparent, **hexagonal** cover
- **changeable, individual security code**
- universal clip-on bracket for seat post, frame tube and for seat pin
- on M-Wave eurohole card



233817 SPIRALKABELSCHLOSS ›S 12.18

12,90 €



12x
1.800

- Ø 12 x 1.800 mm
- mattschwarz transparenter, **hexagonaler** Überzug
- viele verschiedene **computer-designte** Schlüsselvarianten
- Clip-on-Halter für Sattelstütze und Rahmenrohr zur direkten Befestigung am Schlosskopf
- auf M-Wave Eurolockkarte

SPIRAL CABLE LOCK ›S 12.18‹

- Ø 12 x 1,800 mm
- matt black transparent, **hexagonal** cover
- many different **computer-designed** key variants
- clip-on bracket for seat post and frame tube for direct mounting at the lock head
- on M-Wave eurohole card



233819 KABELSCHLOSS ›12.6‹

7,90 €



12x
600

- Ø 12 x 600 mm
- mattschwarz transparenter, **hexagonaler** Überzug
- viele verschiedene **computer-designte** Schlüsselvarianten
- Clip-on-Halter zur direkten Befestigung am Schlosskopf
- auf M-Wave Eurolockkarte

CABLE LOCK ›12.6‹

- Ø 12 x 600 mm
- matt black transparent, **hexagonal** cover
- many different **computer-designed** key variants
- clip-on bracket for direct mounting at the lock head
- on M-Wave eurohole card



SPIRALKABELSCHLÖSSER

SPIRAL CABLE LOCKS

SILICONE

SPIRALKABELSCHLOSS

›DS 12.10 S‹

12,90 €

12x
1.000

- Ø 12 x 1.000 mm
- mit **Silikonüberzug**
- **verstellbarer, persönlicher Sicherheitscode**
- auf M-Wave Eurolockkarte

SPIRAL CABLE LOCK

›DS 12.10 S‹

- Ø 12 x 1,000 mm
- with **silicone cover**
- **changeable, individual security code**
- on M-Wave eurohole card



231060 schwarz

black

231065 grün

green

231067 orange

orange

231068 pink

pink











231069 lila

purple

10,90 €



ART.-NR. UVP	BESCHREIBUNG	DESCRIPTION	
233855 U 15,90 €	SPIRALKABELSCHLOSS ›DS 10.18 L‹ <ul style="list-style-type: none"> • Ø 10 x 1.800 mm • dunkel-transparenter Überzug • 1 blaue LED zur Beleuchtung der Ziffern • wahlweise zu öffnen durch verstellbaren, persönlichen Sicherheitscode oder durch computer-designte Schlüssel • universeller Clip-on-Halter • inkl. Batterien (2 x CR 1220) • auf M-Wave Eurolochkarte 	SPIRAL CABLE LOCK ›DS 10.18 L‹ <ul style="list-style-type: none"> • Ø 10 x 1,800 mm • dark transparent cover • 1 blue LED for illumination of the digits • can be opened by changeable, individual security code or by computer-designed keys • universal clip-on bracket • incl. batteries (2 x CR 1220) • on M-Wave eurohole card 	
233855 U 15,90 €			
233855 U 15,90 €			
233855 U 15,90 €			
233855 U 15,90 €			
233855 U 15,90 €			
233855 U 15,90 €			
233855 U 15,90 €			
233855 U 15,90 €			
230961 U 8,90 €	SPIRALKABELSCHLOSS ›S 10.18‹ <ul style="list-style-type: none"> • Ø 10 x 1.800 mm • Clip-on-Halter (Art. 233849) für Sattelstütze und Rahmenrohr, beidseitig einführbar • mit Staubschutzkappe • auf M-Wave Eurolochkarte 	SPIRAL CABLE LOCK ›S 10.18‹ <ul style="list-style-type: none"> • Ø 10 x 1,800 mm • clip-on bracket (art. 233849) for seat post and frame tube, clip-on possibility from both sides • with dust cap • on M-Wave eurohole card 	
230961 U 8,90 €	<ul style="list-style-type: none"> • dunkel-transparenter Überzug, mit Reflexstreifen 	<ul style="list-style-type: none"> • dark transparent cover, with reflective stripe 	
233840 U	dunkel-transparent	dark transparent	
233862 U	weiß	white	 
233863 U	rot	red	 
233864 U	blau	blue	 
233865 U	grün	green	 
233866 U	gelb	yellow	 
233867 U	orange	orange	 
233868 U 7,90 €	pink	pink	 

233855 U 15,90 €	SPIRALKABELSCHLOSS ›S 8.15 S‹ <ul style="list-style-type: none"> • Ø 8 x 1.500 mm • mit Silikonüberzug • viele verschiedene computer-designte Schlüsselvarianten • auf M-Wave Eurolochkarte 	SPIRAL CABLE LOCK ›S 8.15 S‹ <ul style="list-style-type: none"> • Ø 8 x 1,500 mm • with silicone cover • many different computer-designed key variants • on M-Wave eurohole card 	
233855 U 15,90 €			
233855 U 15,90 €			
233855 U 15,90 €			
233855 U 15,90 €			
231010 U	schwarz	black	
231015 U	grün	green	 
231017 U	orange	orange	 
231018 U	pink	pink	 
231019 U 9,90 €	lila	purple	

ART.-NR. BESCHREIBUNG
UVP

DESCRIPTION



SPIRALKABELSCHLOSS ›DS 8.15‹

- dunkel-transparenter Überzug
- **verstellbarer**, persönlicher Sicherheitscode
- Clip-on-Halter (Art. 233849) für Sattelstütze oder Rahmenrohr, beidseitig einführbar
- auf M-Wave Eurolochkarte

230962
U
8,90 €

- Ø 10 x 1.800 mm
- schwarz, mit **Reflexstreifen**

SPIRAL CABLE LOCK ›DS 8.15‹

- dark transparent cover
- **changeable**, individual security code
- clip-on bracket (art. 233849) for seat post or frame tube, clip-on possibility from both sides
- on M-Wave eurohole card

- Ø 10 x 1,800 mm
- black, with **reflective stripe**



230170
U
7,90 €

Ø 8 x 1.500 mm

Ø 8 x 1,500 mm

8x
1.500



233830 SPIRALKABELSCHLOSS ›S 8.15‹

5,90 €

- Ø 8 x 1.500 mm
- dunkel-transparenter Überzug
- Clip-on-Halter (Art. 233849) für Sattelstütze und Rahmenrohr, beidseitig einführbar
- mit **Staubschutzkappe**
- auf M-Wave Eurolochkarte

8x
1.500

SPIRAL CABLE LOCK ›S 8.15‹

- Ø 8 x 1,500 mm
- dark transparent cover
- clip-on bracket (art. 233849) for seat post and frame tube, clip-on possibility from both sides
- with **dust cap**
- on M-Wave eurohole card



233822 SPIRALKABELSCHLOSS ›S 6.10‹

4,90 €

- Ø 6 x 1.000 mm
- dunkel-transparenter Überzug
- Clip-on-Halter (Art. 233849) für Sattelstütze und Rahmenrohr, beidseitig einführbar
- auf M-Wave Eurolochkarte

6x
1.000

SPIRAL CABLE LOCK ›S 6.10‹

- Ø 6 x 1,000 mm
- dark transparent cover
- clip-on bracket (art. 233849) for seat post and frame tube, clip-on possibility from both sides
- on M-Wave eurohole card



ZAHLENKABELSCHLÖSSER

DIGIT CABLE LOCKS

SHAPE MEMORY

KABELSCHLOSS ›D 12.9 MEM‹

- Ø 12 x 900 mm
- **flexibles TPE-Kabel – lässt sich in beliebige Formen biegen und hält die Form**
- **verstellbarer, persönlicher Sicherheitscode**
- auf M-Wave Eurolochkarte

231127

orange

231125

grün

231128

pink

12,90 €

CABLE LOCK ›D 12.9 MEM‹







- Ø 12 x 900 mm
- **flexible TPE cable – can be put into any shape and keeps the shape**
- **changeable, individual security code**
- on M-Wave eurohole card

orange

green

pink





ART.-NR. UVP	BESCHREIBUNG	DESCRIPTION	
	<p>SILICONE TOUCH</p> <p>12x 650</p> <p>KABELSCHLOSS ›DS 12.6,5 S‹</p> <ul style="list-style-type: none"> • Ø 12 x 650 mm • mit silikonähnlichem Überzug • verstellbarer, persönlicher Sicherheitscode • auf M-Wave Eurolochkarte 	<p>CABLE LOCK ›DS 12.6,5 S‹</p> <ul style="list-style-type: none"> • Ø 12 x 650 mm • with silicone like cover • changeable, individual security code • on M-Wave eurohole card 	
231050 U	schwarz	black	
231052 U	weiß	white	
231053 U	rot	red	
231054 U	blau	blue	
231055 U	grün	green	
231057 U	orange	orange	
231058 U	rosa	rose	
231059 U 9,90 €	lila	purple	

	<p>230180 U 7,90 €</p> <p>12x 600</p> <p>KABELSCHLOSS ›D 12.6‹</p> <ul style="list-style-type: none"> • Ø 12 x 600 mm • geflochtenes Kabel • dunkel-transparenter Überzug • verstellbarer, persönlicher Sicherheitscode • mit Clip-on-Halter für Sattelstütze oder Rahmenrohr • beidseitig einführbar • auf M-Wave Eurolochkarte 	<p>CABLE LOCK ›D 12.6‹</p> <ul style="list-style-type: none"> • Ø 12 x 600 mm • braided design • dark transparent cover • changeable, individual security code • with clip-on bracket for seat post or frame tube • clip-on possibility from both sides • on M-Wave eurohole card 	
--	--	---	--

	<p>230101 U 3,90 €</p> <p>8x 600</p> <p>KABELSCHLOSS</p> <ul style="list-style-type: none"> • Ø 8 x 600 mm • dunkel-transparenter Überzug • mit 4 Zahlenscheiben • Montageverpackung 	<p>CABLE LOCK</p> <ul style="list-style-type: none"> • Ø 8 x 600 mm • dark transparent cover • with 4 digits • OEM 	
--	--	--	---

KABELSCHLÖSSER **CABLE LOCKS**

	<p>230061 29,90 €</p> <p>24x12x 1.000</p> <p>REFLEX</p> <p>KABELSCHLOSS ›STYLE 23.10‹</p> <ul style="list-style-type: none"> • (24 x 12) x 1.000 mm • automatische Verriegelung • hohe Sicherheit durch geflochtenes Doppelkabel und Einschub-Bolzen-technik • transparenter Überzug • mit Reflexstreifen • viele verschiedene computer-designete Schlüsselvarianten • erweiterbar durch Anhängen mehrerer Schlösser • auf M-Wave Eurolochkarte 	<p>CABLE LOCK ›STYLE 23.10‹</p> <ul style="list-style-type: none"> • (24 x 12) x 1,000 mm • automatic locking • high security through braided dual wire innercable and special safety pin technology • transparent cover • with reflective stripe • many different computer-designed key variants • expandable through adding more locks • on M-Wave eurohole card 	 
--	--	--	---

	<p>230164 U 8,90 €</p> <p>15x 800</p> <p>REFLEX</p> <p>KABELSCHLOSS MIT REFLEX-ÜBERZUG ›C15-8 ILLU C‹</p> <ul style="list-style-type: none"> • Kabelschloss (Art. 230161) • Ø 15 x 800 mm • geflochtenes Kabel • automatische Verriegelung • mit Schlossüberzug (Art. 120999) • 360° reflektierend • auf M-Wave Eurolochkarte 	<p>CABLE LOCK WITH REFLECTIVE COVER ›C15-8 ILLU C‹</p> <ul style="list-style-type: none"> • cable lock (art. 230161) • Ø 15 x 800 mm • braided design • automatic locking • with lock cover (art. 120999) • 360° reflective • on M-Wave eurohole card 	
--	--	---	---

Locks

ART.-NR. UVP **BESCHREIBUNG**

DESCRIPTION

SILICONE

KABELSCHLOSS ›S 12.6 S‹

- Ø 12 x 600 mm
- mit **Silikonüberzug**
- viele verschiedene **computer-designte** Schlüsselvarianten
- auf M-Wave Eurolochkarte

CABLE LOCK ›S 12.6 S‹

- Ø 12 x 600 mm
- with **silicone cover**
- many different **computer-designed** key variants
- on M-Wave eurohole card



12x 600

231040 U schwarz

black

231045 U grün

green

231047 U orange

orange

231048 U pink

pink

231049 U lila
8,90 €

purple



230960 KABELSCHLOSS ›C 15.8 ILLU‹

U
7,90 €

- Ø 15 x 800 mm
- **geflochtenes Kabel**
- dunkel-transparenter Überzug
- mit **Reflexstreifen**
- **automatische Verriegelung**
- auf M-Wave Eurolochkarte

CABLE LOCK ›C 15.8 ILLU‹

- Ø 15 x 800 mm
- **braided design**
- dark transparent cover
- with **reflective stripe**
- **automatic locking**
- on M-Wave eurohole card



REFLEX

15x 800

PANZERGLIEDERSCHLÖSSER

JOINT ARMORED LOCKS

230815 PANZERGLIEDERSCHLOSS ›H 24.10‹

U
14,90 €

- Ø 24 x 1.000 mm
- **starke Ausführung**
- dunkel-transparenter Überzug
- viele verschiedene **computer-designte** Schlüsselvarianten
- auf M-Wave Eurolochkarte

JOINT ARMORED LOCK ›H 24.10‹

- Ø 24 x 1,000 mm
- **heavy duty**
- dark transparent cover
- many different **computer-designed** key variants
- on M-Wave eurohole card



24x 1.000

230186 PANZERGLIEDERSCHLOSS ›HD 18.8‹

U
12,90 €

- Ø 18 x 800 mm
- **starke Ausführung**
- dunkel-transparenter Überzug
- **5 Zahlenscheiben**
- **verstellbarer**, persönlicher Sicherheitscode
- auf M-Wave Eurolochkarte

JOINT ARMORED LOCK ›HD 18.8‹

- Ø 18 x 800 mm
- **heavy duty**
- dark transparent cover
- **5 digits**
- **changeable**, individual security code
- on M-Wave eurohole card



18x 800

5x

230810 PANZERGLIEDERSCHLOSS ›H 18.8‹

U
7,90 €

- Ø 18 x 800 mm
- mit **Staubschutzkappe**
- dunkel-transparenter Überzug
- auf M-Wave Eurolochkarte

JOINT ARMORED LOCK ›H 18.8‹

- Ø 18 x 800 mm
- with **dust cap**
- dark transparent cover
- on M-Wave eurohole card



18x 800

ART.-NR. BESCHREIBUNG
UVP

DESCRIPTION

KETTENSCHLÖSSER

CHAINLOCKS

230950 KETTENSCHLOSS ›C 10.9-360‹

54,90 €

10 x 10 x 900



- 10 x 10 x 900 mm
- **besonders widerstandsfähig** durch **gehärtete quadratische Kettenglieder** und **robusten Schließzylinder**
- viele verschiedene **computer-designte** Schlüsselvarianten
- **360° drehbarer Verschlusskopf**
- mit Staubschutzkappe
- mit Textilüberzug
- mit M-Wave Banderole

CHAIN LOCK ›C 10.9-360‹

- 10 x 10 x 900 mm
- **very robust** because of **hardened square chain links** and **robust cylinder lock**
- many different **computer-designed** key variants
- **360° turnable lock head**
- with dust cap
- with textile cover
- with M-Wave banderole



230313 KETTENSCHLOSS ›C 10.11‹

23,90 €

10 x 10 x 1.100



- 10 x 10 x 1.100 mm
- **besonders widerstandsfähig** durch **quadratische Kettenglieder**
- **automatische Verriegelung**
- viele verschiedene **computer-designte** Schlüsselvarianten
- mit Textilüberzug
- mit **Staubschutzkappe**
- mit M-Wave Banderole

CHAIN LOCK ›C 10.11‹

- 10 x 10 x 1,100 mm
- **very robust** because of **square chain links**
- **automatic locking**
- many different **computer-designed** key variants
- with textile cover
- with **dust cap**
- with M-Wave banderole



KETTENSCHLOSS ›C 6.8,5‹

- Ø 6 x 850 mm
- **automatische Verriegelung**
- mit Staubschutzkappe
- viele verschiedene **computer-designte** Schlüsselvarianten
- mit Textilüberzug
- mit M-Wave Banderole

CHAIN LOCK ›C 6.8,5‹

- Ø 6 x 850 mm
- **automatic locking**
- with dust cap
- many different **computer-designed** key varieties
- with textile cover
- with M-Wave banderole



230963 mit Reflexstreifen

U
14,90 €

with reflective stripe

230315 ohne Reflexstreifen

U
13,90 €

without reflective stripe



ZAHLEN-KETTENSCHLOSS ›D 6.8,5‹

- Ø 6 x 850 mm
- mit **5 Zahlenscheiben**
- mit **verstellbarem**, persönlichem Sicherheitscode
- mit Textilüberzug
- mit M-Wave Banderole

COMBINATION CHAIN LOCK ›D 6.8,5‹

- Ø 6 x 850 mm
- with **5 digits**
- with **changeable**, individual security codes
- with textile cover
- with M-Wave banderole



230964 mit Reflexstreifen

U
14,90 €

with reflective stripe

230316 ohne Reflexstreifen

U
13,90 €

without reflective stripe



5x

ART.-NR. BESCHREIBUNG
UVP

DESCRIPTION

230317 ZAHLEN-KETTENSCHLOSS

›D 3,5.9‹

COMBINATION CHAIN LOCK

›D 3,5.9‹

8,90 €

- Ø 3,5 x 900 mm
- mit **verstellbarem**, persönlichem Sicherheitscode
- mit Textilüberzug
- mit M-Wave Banderole

- Ø 3.5 x 900 mm
- with **changeable**, individual security code
- with textile cover
- with M-Wave banderole



FALTSCHLÖSSER

FOLDING LOCKS

230187 FALTSCHLOSS ›F 1240/8‹

54,90 €

- **XL: Länge 1.240 mm**
- **8 Glieder aus gehärtetem Stahl** mit Kunststoffummantelung, 8 x 25 x 165 mm
- kompaktes **Faltmaß**: 210 x 92 x 50 mm
- mit **Halterung** und Klettverschlüssen zur flexiblen Rahmenbefestigung oder zur Montage an den Flaschenhalterösen
- 2 Schlüssel, davon **1 mit LED-Beleuchtung**, inkl. Batterien (1x CR 1220)
- in M-Wave Blisterverpackung

FOLDING LOCK ›F 1240/8‹

- **XL: length 1,240 mm**
- **8 hardened steel links** with plastic cover, 8 x 25 x 165 mm
- folded size: 210 x 92 x 50 mm
- with **bracket** and hook and loop fasteners for flexible frame attachment or mounting to the bottle cage eyelets
- 2 keys, **1 with LED light**, incl. batteries (1x CR 1220)
- in M-Wave blister packaging

1.240 mm

XL

SECURITY



FALTSCHLOSS

875 mm

- Länge **875 mm**
- **6 Glieder aus gehärtetem Stahl** mit Kunststoffummantelung, 8 x 25 x 152 mm
- kompaktes **Faltmaß**: 195 x 72 x 50 mm
- mit **Halterung** und Klettverschlüssen zur Rahmenbefestigung oder zur Montage an den Flaschenhalterösen
- 2 Schlüssel

FOLDING LOCK

- length **875 mm**
- **6 hardened steel links** with plastic cover, 8 x 25 x 152 mm
- folded size: 195 x 72 x 50 mm
- with **bracket** and velcros for frame mounting or mounting to the bottle cage eyelets
- 2 keys

SECURITY



230194 ›F 875/6‹

32,90 €

1 Schloss in M-Wave Blisterverpackung

›F 875/6‹

1 lock in M-Wave blister packaging

230197 ›F 875/6 TWIN‹

64,90 €

- **Set aus zwei Schlössern** mit je **2 identischen Schlüsseln**, die je in beide Schließzylinder passen
- 2 Schlösser in M-Wave Blisterverpackung

›F 875/6 TWIN‹

- **set of two locks**, each with **2 identical keys**, which fit in both key cylinders
- 2 locks in M-Wave blister packaging

2x



230196 FALT-DISC-SCHLOSS ›F 600 D‹

34,90 €

- **14 starke**, halbrunde **Stahlglieder** mit Kunststoffüberzug
- Länge 600 mm
- **kompaktes faltmaß**, ca. 7 cm x 5 cm
- mit 2 Schlüsseln
- mit Clip-on-Halter (Art. 230198)
- Schloss **diebstahlsicher** am Halter fixierbar
- in M-Wave Blisterverpackung

FOLDING DISC LOCK ›F 600 D‹

- **14 strong**, half-rounded **steel links** with plastic cover
- length 600 mm
- **compact folding size**, approx. 7 cm x 5 cm
- with 2 keys
- with clip-on bracket (art. 230198)
- **anti-theft-secured** fixing at the bracket
- in M-Wave blister packaging

600 mm



ART.-NR. UVP **BESCHREIBUNG**

DESCRIPTION

234000 U **ALARMANLAGE ›WATCH DOG‹**

17,90 €



- automatische Alarmierung durch **Bewegungssensor**
- Sensibilität **einstellbar**
- Lautstärke **120 db**
- Codierung mit 3 Zahlen persönlich **einstellbar**
- Halter für Rohr-Ø 25 - 30 mm
- inkl. Batterie (9 V)
- auf M-Wave Eurolochkarte

ALARM SYSTEM ›WATCH DOG‹

- automatic alarm by **movement sensor**
- **adjustable** sensitivity
- loudness **120 db**
- **adjustable** encoding by 3 numbers
- bracket for tubes with Ø 25 - 30 mm
- incl. battery (9 V)
- on M-Wave eurohole card



230054 U **ALARMSCHLOSS ›LOCK'N'ROLL ALARM‹**

29,90 €



- Kleines, leichtes Aufrollschloss mit Alarmfunktion!
- **Alarm** bei **Bewegung** oder **Durchtrennen** des Kabels
 - **Empfindlichkeit einstellbar**
 - Lautstärke **90 db**
 - nur 84 g (o. Batterien)
 - mit **4 Zahlenscheiben**
 - mit **verstellbarem**, persönlichem **Sicherheitscode**
 - Kabel **1,6 x 730 mm**
 - schwarzes Gehäuse
 - inkl. Batterien
 - in M-Wave Blisterverpackung

ALARM LOCK ›LOCK'N'ROLL ALARM‹

- Small, light roll-up lock with alarm function!
- **alarm** when lock is **moved** or cable is **cut**
 - **adjustable sensitivity**
 - loudness **90 db**
 - only 84 g (w/o batteries)
 - with **4 digits**
 - with **changeable**, individual **security code**
 - cable **1.6 x 730 mm**
 - black housing
 - incl. batteries
 - in M-Wave blister packaging



230051 U **AUFROLL-KABELSCHLOSS ›LOCK'N'ROLL D 24.9‹**

11,90 €



- Klein, leicht und praktisch! Durch Knopfdruck rollt sich das Kabel selbst auf.
- mit **4 Zahlenscheiben**
 - mit **verstellbarem**, persönlichem **Sicherheitscode**
 - Kabel **2,4 x 900 mm**
 - Gehäuse dunkel-transparent
 - auf M-Wave Eurolochkarte

ROLL UP CABLE LOCK ›LOCK'N'ROLL D 24.9‹

- Small, light and handy! By pressing the button the cable rolls up automatically.
- with **4 digits**
 - with **changeable**, individual security code
 - cable **2.4 x 900 mm**
 - dark transparent housing
 - on M-Wave eurohole card



10x 5.000 **ABSPERRKABEL**

- mit 2 **Schlaufenenden**
- zur **Verlängerung des Absperrradius**
- ideal um mehrere Räder zu sichern
- ideal auch in Verbindung mit kleinen Bügelschlössern z. B. Art. 230121, ...
- auf M-Wave Eurolochkarte

LOCK CABLE

- with 2 **loopends**
- for **extending the locking range**
- protection of multiple bicycles
- ideal in conjunction with small u-locks e. g. art. 230121, ...
- on M-Wave eurohole card



230340 U **›S 10.50 L‹**

14,90 €

10 x 5.000 mm

›S 10.50 L‹

10 x 5,000 mm

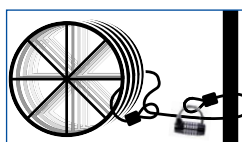

230130 U **›S 8.18 L‹**

4,90 €

8 x 1.800 mm

›S 8.18 L‹

8 x 1,800 mm

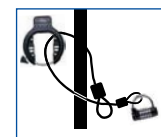
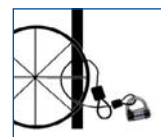
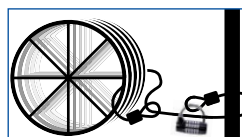

ART.-NR. UVP	BESCHREIBUNG	DESCRIPTION
	 VORHÄNGESCHLOSS ›PD 5‹ <ul style="list-style-type: none"> mit 5 Zahlenscheiben mit verstellbarem, persönlichem Sicherheitscode Bügel aus gehärtetem Stahl 7 mm Bügelstärke 	PADLOCK ›PD 5‹ <ul style="list-style-type: none"> with 5 digits with changeable, individual security code hardened steel shackle 7 mm shackle thickness
230121 U	auf M-Wave Eurolochkarte	on M-Wave eurohole card
230120 U 9,90 €	Montageverpackung	OEM

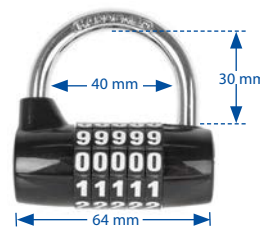

230124 5,90 €	VORHÄNGESCHLOSS ›PD 3 L‹ <ul style="list-style-type: none"> mit 3 Zahlenscheiben mit Mini-Spiralkabel 3 x 1200 mm Überzug transparent smoke mit verstellbarem, persönlichem Sicherheitscode auch geeignet zum Sichern von Taschen, Helmen am Fahrrad, ... auf M-Wave-Eurolochkarte 	PADLOCK ›PD 3 L‹ <ul style="list-style-type: none"> with 3 digits with mini spiral cable 3 x 1200 mm cover transparent smoke with changeable, individual security code also suitable to secure bags, helmets on the bike, ... on M-Wave eurohole card
-------------------------	--	---



BÜGELSCHLÖSSER

U-LOCKS

234022 U 21,90 €	ZAHLEN-BÜGELSCHLOSS ›BD 260‹ <ul style="list-style-type: none"> mit Halter mit 4 Zahlenscheiben mit verstellbarem, persönlichem Sicherheitscode Ø 14 mm Bügelstärke Außenmaß: 124 x 260 mm Innenmaß: 76 x 200 mm mit M-Wave Banderole 	DIGIT U-LOCK ›BD 260‹ <ul style="list-style-type: none"> with bracket with 4 digits with changeable, individual security code Ø 14 mm shackle thickness outer size: 124 x 260 mm inner size: 76 x 200 mm with M-Wave banderole
-------------------------------	---	--

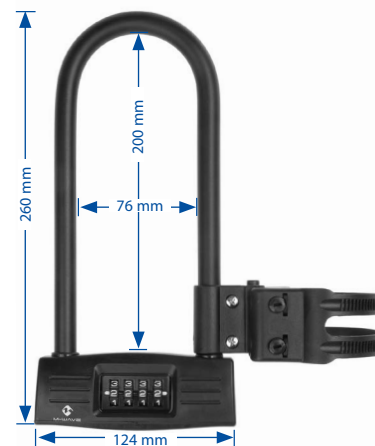

234025 U 21,90 €	BÜGELSCHLOSS MIT SPIRALKABEL ›B & S‹ <ul style="list-style-type: none"> Set aus Bügel Schloss und Spiralkabel zur optimalen Sicherung des Fahrrads mit M-Wave Banderole <p>Spiralkabel mit Schlaufen (Art. 230130)</p> <ul style="list-style-type: none"> 8 x 1.800 mm mit 2 unterschiedlich großen Schlaufenenden zur Verlängerung des Absperrradius <p>Bügel Schloss (Art. 234012)</p> <ul style="list-style-type: none"> mit Halter und Staubschutzkappe erhöhte Sicherheit durch quadratische Form Ø 15 mm Bügelstärke Außenmaß: 165 x 247 mm Innenmaß: 106 x 188 mm viele verschiedene computer-designte Schlüsselvarianten 	U-LOCK WITH SPIRAL CABLE ›B & S‹ <ul style="list-style-type: none"> set of u-lock and spiral cable for optimum protection of the bicycle with M-Wave banderole <p>loop spiral cable (art. 230130)</p> <ul style="list-style-type: none"> 8 x 1,800 mm with 2 loopends of different size for extending the locking range <p>u-lock (art. 234012)</p> <ul style="list-style-type: none"> with bracket and dust cap increased security through square shape Ø 15 mm shackle thickness outer size: 165 x 247 mm inner size: 106 x 188 mm many different computer-designed key variants
-------------------------------	--	--

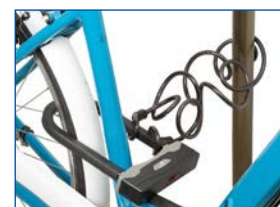
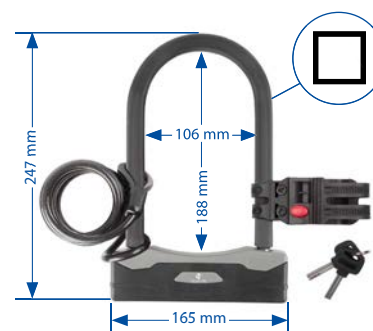

ART.-NR. UVP **BESCHREIBUNG**

DESCRIPTION

234012 BÜGELSCHLOSS ›B 247‹

- 16,90 €
- mit Halter und Staubschutzkappe
- **erhöhte Sicherheit** durch quadratische Form
- **Ø 15 mm** Bügelstärke
- Außenmaß: 165 x 247 mm
- Innenmaß: 106 x 188 mm
- viele verschiedene **computer-designte** Schlüsselvarianten
- mit M-Wave Banderole

U-LOCK ›B 247‹

- with bracket and dust cap
- **increased security** through square shape
- **Ø 15 mm** shackle thickness
- outer size: 165 x 247 mm
- inner size: 106 x 188 mm
- many different **computer-designed** key variants
- with M-Wave banderole

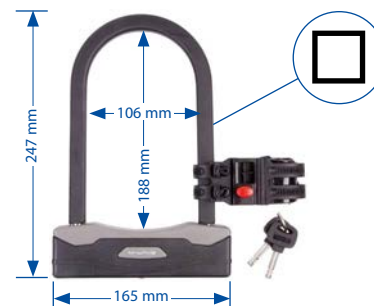

234010 BÜGELSCHLOSS ›B 245‹

- 12,90 €
- mit Halter und Staubschutzkappe
- **Ø 14 mm** Bügelstärke
- Außenmaß: 197 x 245 mm
- Innenmaß: 105 x 205 mm
- viele verschiedene **computer-designte** Schlüsselvarianten
- mit M-Wave Eurolochkarte

U-LOCK ›B 245‹

- with bracket and dust cap
- **Ø 14 mm** shackle thickness
- outer size: 197 x 245 mm
- inner size: 105 x 205 mm
- many different **computer-designed** key variants
- with M-Wave eurohole card

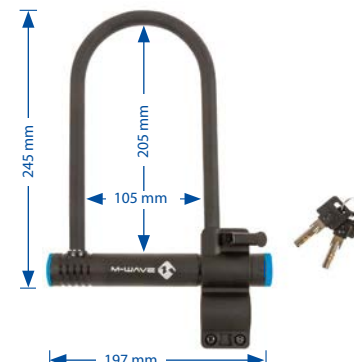

RAHMENSCHLÖSSER

FRAME LOCKS

231451 RAHMENSCHLOSS MIT KETTE ›RINGCHAIN XL‹

- 23,90 €
- **70 mm Durchlaufbreite** für **besonders breite Reifen**
- für Montage an der Pletscherplatte oder den Sitzrohrstreben
- mit **quadratischen Kettengliedern**, 5,5 x 5,5 x **1.000 mm** (Art. 231452) zur **Verlängerung des Absperrradius**, mit schwarzem Textilüberzug
- Kette mit Kletttrienen zum Aufrollen und Fixieren
- mit Befestigungsmaterial
- auf M-Wave Eurolochkarte

FRAME LOCK WITH CHAIN ›RINGCHAIN XL‹

- **70 mm inner width** for **very wide tires**
- for mounting on the Pletscher plate or seat stays
- with **square chain links**, 5,5 x 5,5 x **1,000 mm** (art. 231452) for **extending the locking range**, with black textile cover
- chain with hook and loop straps for rolling up and fixing
- with mounting material
- on M-Wave eurohole card



SCHLOSSKETTE

- **Ersatz-/Verlängerungskette** für Rahmenschloss Art. 231451 und **andere Rahmenschlösser**
- zur Verlängerung des Absperrradius
- mit schwarzem Textilüberzug
- Kette mit Kletttrienen zum Aufrollen und Fixieren
- Montageverpackung

LOCK CHAIN

- **replacement and extension chain** for frame lock art. 231451 and **other frame locks**
- for extending the locking range
- with black textile cover
- chain with hook and loop straps for rolling up and fixing
- OEM



231452 ›C 5,5.10‹
5,5 x 5,5 x **1.000 mm**

›C 5,5.10‹
5,5 x 5,5 x **1,000 mm**

231453 ›C 5,5.14‹
5,5 x 5,5 x **1.400 mm**

›C 5,5.14‹
5,5 x 5,5 x **1,400 mm**

122357 AUFBEWAHRUNGSTASCHE FÜR SCHLOSSKETTEN ›TILBURG M‹

- 6,90 €
- mit Clip-on-Halter (Art. 122299)
- durch Reißverschluss nach unten **erweiterbar**
- mit **Rücklichthalter** und 3 **Kletttrienen** unten (z. B. für Luftpumpe)
- mit Reflexstreifen
- Größe: ca. 160 x 80 mm
- Höhe: ca. 80 - 150 mm

STORAGE BAG FOR LOCK CHAINS ›TILBURG M‹

- with clip-on bracket (art. 122299)
- through zipper **expandable** at the bottom
- with **light bracket** and 3 **hook and loop fasteners** at the bottom (e. g. for pump)
- with reflective stripes
- size: approx. 160 x 80 mm
- height: approx. 80 - 150 mm



ART.-NR. BESCHREIBUNG
UVP

DESCRIPTION

RAHMENSCHLOSS ›BOOSTER‹

- **Fahrradschloss und Brake-Booster**
- kann sowohl bei **gedeferten, als auch ungedeferten** Rädern an den **Brems-Pivots der Vorderradgabel und des Hinterbaus** montiert werden
- zusätzliche Befestigungsmöglichkeit **an der Platte zw. den Sitzrohrstreben**
- auf M-Wave Eurolochkarte

FRAME LOCK ›BOOSTER‹

- **bicycle lock and brake booster**
- can be mounted on bikes **with suspension** or bikes **w/o suspension** on the **brake-pivots of front fork and seat stays**
- also possible to fasten **on the seat stay plate**
- on M-Wave eurohole card



231440

silber

silver

231441
U
27,90 €

schwarz

black

231458 **RAHMENSCHLOSS MIT KETTE ›RINGCHAIN‹**
U
21,90 €

5,5 x
5,5 x
1.500



- 63 mm Durchlaufbreite
- **inkl. quadratischen Kettengliedern** 5,5 x 5,5 x 1.500 mm mit Textilüberzug
- Kette mit Klettriemen zum Aufrollen und Fixieren
- mit zwei Schrauben und abnehmbarem Distanzstück für Montage an der Pletscherplatte
- auf M-Wave Eurolochkarte

FRAME LOCK WITH CHAIN ›RINGCHAIN‹

- 63 mm inner width
- **incl. square chain links** 5.5 x 5.5 x 1,500 mm with textile cover
- chain with hook and loop straps for rolling up and fixing
- with two screws and detachable spacers for mounting on the Pletscher plate
- on M-Wave eurohole card



231465 **RAHMENSCHLOSS MIT KABEL ›RINGLOOP‹**
U
19,90 €

- 63 mm Durchlaufbreite
- **inkl. Befestigungskabel** 10 x 1.500 mm
- inkl. Halter für Kabel
- Kabel **abnehmbar**
- mit zwei Schrauben und abnehmbarem Distanzstück für Montage an der Pletscherplatte
- auf M-Wave Eurolochkarte

FRAME LOCK WITH CABLE ›RINGLOOP‹

- 63 mm inner width
- **incl. fixation cable** 10 x 1,500 mm
- incl. holder for cable
- cable **removable**
- with two screws and detachable spacers for mounting on the Pletscher plate
- on M-Wave eurohole card



231470 **RAHMENSCHLOSS ›XL RING‹**

14,90 €

- **70 mm Durchlaufbreite** für besonders **breite Reifen**
- 2 Schlüssel mit **Licht**
- mit zwei Schrauben und abnehmbarem Distanzstück für Montage an der Pletscherplatte
- Montageverpackung

FRAME LOCK ›XL RING‹

- **70 mm inner width** for **very wide tires**
- 2 keys with **light**
- with two screws and detachable spacers for mounting on the Pletscher plate
- OEM



RAHMENSCHLOSS ›RING‹

- 64 mm Durchlaufbreite
- Montageverpackung

FRAME LOCK ›RING‹

- 64 mm inner width
- OEM

231461 mit **abnehmbarem Distanzstück** zur Montage an der Pletscherplatte

with **detachable spacer** for mounting on Pletscher plate

231464 ohne Bolzen und Distanzhülsen

without bolts and spacers

9,90 €



ART.-NR. UVP **BESCHREIBUNG**

DESCRIPTION

M-WAVE COMPUTER – KLEINER PREIS – GROSSE LEISTUNG

- **gut lesbares** und temperaturbeständiges Display
- **japanische Batterien**
- doppelte **Qualitätskontrolle**
- super Preis-Leistungsverhältnis

M-WAVE COMPUTER – LOW PRICE – BIG PERFORMANCE

- **easy-to-read** and temperature-resistant display
- **Japanese batteries**
- double **quality check**
- super price-performance ratio

244750 FAHRRADCOMPUTER ›M21W‹

27,90 €

21 Funktionen mit Touchscreen und Funkübertragung:



- Geschwindigkeit: akt. / Ø / max.
- Geschwindigkeitsvergleich
- Gesamt- / Tageskilometer
- Kilometerstand speichern
- automatischer Fahrzeitmesser
- automatischer Anzeigenwechsel
- Digitaluhr
- Stoppuhr
- Kalorienzähler
- Temperaturanzeige
- Auto Start / Stopp
- Kilometer- / Meilenauswahl
- Displaybeleuchtung
- Service Programm
- Screenshot-Funktion
- Batteriezustandsanzeige
- inkl. Batterien (CR 2032, Art. 640814)
- Montage am **Lenker oder Vorbau**
- Ersatz-/Zusatzhalter-Set Art. 244797



BICYCLE COMPUTER ›M21W‹

21 functions with touchscreen and wireless transmission:

- speed: current / Ø / max.
- speed comparator
- total distance / trip distance
- odometer save function
- auto trip timer
- auto scan
- digital clock
- stopwatch
- calorie consumption
- temperature
- auto start / stop
- kilometres / miles selection
- display backlight
- service program
- freeze frame function
- battery level indicator
- incl. batteries (CR 2032, art. 640814)
- mounting at the **handlebar or stem**
- additional replacement bracket set art. 244797



244732 FAHRRADCOMPUTER ›M14W‹

29,90 €

14 Funktionen mit digitaler Funkübertragung:



- Geschwindigkeit: akt. / Ø / max.
- Geschwindigkeitstendenz / -vergleich
- Gesamt- / Tageskilometer
- Kilometerstand speichern
- automatischer Fahrzeitmesser
- automatischer Anzeigenwechsel
- Screenshot-Funktion
- Digitaluhr
- Auto Start / Stopp
- Auto An / Aus
- Kilometer- / Meilenauswahl
- Raddurchmesser einstellbar
- wassergeschützt (IP 44)
- inkl. Batterien (CR 2032, Art. 640814)
- **werkzeuglose Montage** am Lenker oder Vorbau (Ersatz-/Zusatzhalter-Set Art. 244796)
- Anleitungen in CS, DE, EN, FR, HU, IT, NL, PL

BICYCLE COMPUTER ›M14W‹

14 functions with digital wireless transmission:

- speed: current / Ø / max.
- speed tendency / speed comparator
- total distance / trip distance
- odometer save function
- auto trip timer
- auto scan
- freeze frame function
- digital clock
- auto start / stop
- auto power on / off
- kilometres / miles selection
- adjustable wheel size
- water protected (IP 44)
- incl. batteries (CR 2032, art. 640814)
- **toolless mounting** at the handlebar or stem (additional replacement bracket set art. 244796)
- manuals in CS, DE, EN, FR, HU, IT, NL, PL



ART.-NR. UVP **BESCHREIBUNG**

DESCRIPTION

244733 U FAHRRADCOMPUTER ›M16‹

16,90 €

16 Funktionen:

- Geschwindigkeit: akt. / Ø / max.
- Geschwindigkeitstendenz / -vergleich
- Gesamt- / Tageskilometer
- Kilometerstand speichern
- automatischer Fahrzeitmesser
- automatischer Anzeigenwechsel
- Service Programm
- Screenshot-Funktion
- Digitaluhr
- Temperaturanzeige: °C / °F wählbar
- Auto Start / Stopp
- Auto An / Aus
- Kilometer- / Meilenauswahl
- Raddurchmesser einstellbar
- wassergeschützt (IP 44)
- inkl. Batterie (CR 2032, Art. 640814)
- **werkzeuglose Montage** am Lenker oder Vorbau (Ersatz- / Zusatzhalter-Set Art. 244795)
- Anleitungen in CS, DE, EN, FR, HU, IT, NL, PL



BICYCLE COMPUTER ›M16‹

16 functions:

- speed: current / Ø / max.
- speed tendency / speed comparator
- total distance / trip distance
- odometer save function
- auto trip timer
- auto scan
- service program
- freeze frame function
- digital clock
- temperature: °C / °F selectable
- auto start / stop
- auto power on / off
- kilometres / miles selection
- adjustable wheel size
- water protected (IP 44)
- incl. batteries (CR 2032, art. 640814)
- **toolless mounting** at the handlebar or stem (additional replacement bracket set art. 244795)
- manuals in CS, DE, EN, FR, HU, IT, NL, PL



244734 U FAHRRADCOMPUTER ›M12‹

15,90 €

12 Funktionen:

- Geschwindigkeit: akt. / Ø / max.
- Geschwindigkeitstendenz / -vergleich
- Gesamt- / Tageskilometer
- automatischer Fahrzeitmesser
- automatischer Anzeigenwechsel
- Digitaluhr
- Auto Start / Stopp
- Auto An / Aus
- Kilometer- / Meilenauswahl
- Raddurchmesser einstellbar
- wassergeschützt (IP 44)
- inkl. Batterie (CR 2032, Art. 640814)
- **werkzeuglose Montage** am Lenker oder Vorbau (Ersatz- / Zusatzhalter-Set Art. 244795)
- Anleitungen in CS, DE, EN, FR, HU, IT, NL, PL



BICYCLE COMPUTER ›M12‹

12 functions:

- speed: current / Ø / max.
- speed tendency / comparator
- total distance / trip distance
- auto trip timer
- auto scan
- digital clock
- auto start / stop
- auto power on / off
- kilometres / miles selection
- adjustable wheel size
- water protected (IP 44)
- incl. batteries (CR 2032, art. 640814)
- **toolless mounting** at the handlebar or stem (additional replacement bracket set art. 244795)
- manuals in CS, DE, EN, FR, HU, IT, NL, PL



FAHRRADCOMPUTER ›XIV SILICONE‹

Mit farbigen, austauschbaren Silikonhüllen

14 Funktionen:

- **digitale Funkübertragung**
- Geschwindigkeit: akt. / Ø / max.
- Geschwindigkeitstendenz / -vergleich
- Gesamt- / Tageskilometer
- automatischer Anzeigenwechsel
- Uhrzeit
- CO²-Ersparnis
- Kalorienzähler
- Temperaturanzeige: °C / °F wählbar
- Auto Start / Stopp
- Kilometer- / Meilenauswahl
- Raddurchmesser einstellbar
- inkl. Batterie (L1154F, Art. 640818)
- wassergeschützt
- **werkzeuglose Montage** am Lenker oder Vorbau und um **90° drehbar**
- Anleitungen in CS, DE, EN, FR, HU, IT, NL, PL



90°

BICYCLE COMPUTER ›XIV SILICONE‹

With coloured, exchangeable silicone covers

14 functions:

- **digital wireless transmission**
- speed: current / Ø / max.
- speed tendency / comparator
- total distance / trip distance
- auto scan
- clock
- CO² emission reduction
- calorie consumption
- temperature: °C / °F selectable
- auto start / stop
- kilometres / miles selection
- adjustable wheel size
- incl. battery (L1154F, art. 640818)
- water protected
- **toolless mounting** at the handlebar or stem and **90° rotatable**
- manuals in CS, DE, EN, FR, HU, IT, NL, PL



244710 schwarze Silikonhülle

33,90 €

244714 gelbe Silikonhülle

244715 rosa Silikonhülle

244718 orange Silikonhülle

29,90 €

black silicone cover

yellow silicone cover

rose silicone cover

orange silicone cover

ART.-NR. UVP	BESCHREIBUNG	DESCRIPTION
-----------------	--------------	-------------

ERSATZTEILE FÜR COMPUTER

SPARE PARTS FOR COMPUTER

244799 Ersatz- / Zusatzsender
29,90 €
 • **Geschwindigkeitssensor** und **Trittfrequenzsensor**
 • für **kabellose** Fahrradcomputer Art. 244730 und 244731
 • inkl. Batterien
 • inkl. Montagematerial
 • Montageverpackung

Replacement / additional transmitters
 • **sensor for speed and cadence**
 • for **wireless** bicycle computers art. 244730 and 244731
 • incl. batteries
 • incl. mounting material
 • OEM



244796 Ersatz- / Zusatzhalter-Set
4,90 €
 • für **kabellose** Fahrradcomputer Art. 244730, 244731 und 244732
 • im Polybeutel mit M-Wave Header

Replacement / additional bracket set
 • for **wireless** bicycle computers art. 244730, 244731 and 244732
 • in PE bag with M-Wave header



244795 Ersatz- / Zusatzhalter-Set
5,90 €
 • für Fahrradcomputer Art. 244733 und 244734
 • im Polybeutel mit M-Wave Header

Replacement / additional bracket set
 • for bicycle computers art. 244733 and 244734
 • in PE bag with M-Wave header



244698 **LENKERHALTER**
41,90 €
›DAVENPORT ARM‹
 • Positionierung vor dem Lenker für **bessere Ablesbarkeit** und **zusätzlichen Platz** am Lenker
 • universell passend für **Garmin Edge** Serie und **Garmin Forerunner** Serie (Schnellwechselkit nicht enthalten, kein original Garmin Ersatzteil)
 • sehr **stabil** und **passgenau** durch **CNC-gefrästes Aluminium**
 • für Lenkerdurchmesser **22,2 - 31,8 mm**
 • Länge einstellbar
 • auf M-Wave Eurolochkarte



HANDLEBAR BRACKET
›DAVENPORT ARM‹
 • positioning in front of the handlebar for better **readability** and **more space** at the handlebar
 • universally suitable for **Garmin Edge** series and **Garmin Forerunner** series (quick change kit not included, no original Garmin spare part)
 • very **rigid** and **accurately fitting** by **CNC machined aluminium**
 • for **22.2 - 31.8 mm** handlebar diameter
 • length adjustable
 • on M-Wave eurohole card



244691 **AHEADKAPPEN-HALTERUNG**
10,90 €
›DAVENPORT AHEAD‹
 • zur **Gabelschaft- / Ahead-Montage** (1 1/8")
 • universell passend für Garmin, ... (kein original Garmin, ... Ersatzteil)
 • auf M-Wave Eurolochkarte

AHEAD CAP BRACKET
›DAVENPORT AHEAD‹
 • for **steerer / ahead-cap mount** (1 1/8")
 • universally suitable for Garmin, ... (no original Garmin, ... spare part)
 • on M-Wave eurohole card



ART.-NR. BESCHREIBUNG
UVP

DESCRIPTION

244690 U **UNIVERSELLE ADAPTERPLATTE**
7,90 € **›DAVENPORT PLUG‹**

- zur **Befestigung von Mobiltelefonen, Navigationsgeräten, ... auf Garmin-Halterungen** (kein original Garmin Ersatzteil)
- mit **3M** Klebepad und Sicherheits-schrauben
- **Hand- und Sicherheitschlaufe** verhindert unbeabsichtigtes Herunterfallen des Gerätes
- auf M-Wave Eurolochkarte

UNIVERSAL ADAPTER PLATE
›DAVENPORT PLUG‹

- for **mounting of mobile phones, navigation devices, ... to Garmin mounts** (no original Garmin spare part)
- with **3M** glue pad and safety screws
- **hand and safety sling** prevents the device from accidentally falling
- on M-Wave eurohole card



HALTER FÜR AIRTAG
›AIRCASE BC‹

- ermöglicht die **unauffällige Anbringung des Apple AirTag Senders unter dem Flaschenhalter**
- inkl. längerer Schrauben

BRACKET FOR AIRTAG
›AIRCASE BC‹

- enables the **Apple AirTag transmitter to be unobtrusively attached under the bottle holder**
- incl. extra long screws



245026 auf M-Wave Eurolochkarte

on M-Wave eurohole card

245025 Montageverpackung
15,99 €

OEM



ART.-NR. UVP **BESCHREIBUNG**

DESCRIPTION

SÄTTEL VON M-WAVE

Hervorragende Qualität zum kleinen Preis!

Mit unserer Sattelkollektion von M-Wave ist es uns gelungen, Ihnen Sättel mit **technischen Finessen** und einer Ausstattung anzubieten, wie dies bisher nur in höheren Preislagen möglich war. Dies gilt sowohl für das **Design** als auch für **funktionelle Ausstattungsmerkmale**, wie verschiedene **Druckentlastungssysteme, Luftstromkühlung** und **Abriebschutz**. Eine **sehr gute Verarbeitung** ist selbstverständlich.

SADDLES MADE BY M-WAVE

Excellent quality for a small price!

With our M-Wave saddle collection we managed to offer you saddles with **technical finesse** and specs that have only been possible in higher price levels so far. This applies for their **design** as well as **functional details** like several **pressure relief systems, air channel cooling** or **rub-off protection**. A **very good finish** is self-evident.



M-WAVE



COMPETITION

COMPETITION

251010 SATTEL ›SPIDER‹

U
24,90 €

- **W-B-W**-Gestell mit **Skala**
- **V-Design**
- **"Full Cut"**
- mit **Abriebschutz rechts** und **links**
- nur **312 g**
- L = 280 x B = 144 mm

SADDLE ›SPIDER‹

- **W-B-W** rails with **scale**
- **V-Design**
- **"Full Cut"**
- with **abrasion protection right** and **left**
- only **312 g**
- L = 280 x W = 144 mm



251038 SATTEL ›COMP XI‹

19,90 €

NYLON

- **stabile Nylon-Schale**
- **CrMo**-Gestell mit **Skala**
- **"Full Cut"**
- **wasserdicht durch Vakuum-Technologie** (verschweißte, wasserdichte und nahtlose Oberfläche)
- nur **282 g**
- L = 255 x B = 145 mm

SADDLE ›COMP XI‹

- **stable nylon base**
- **CrMo** rails with **scale**
- **"Full Cut"**
- **waterproof because of vacuum technology** (welded, waterproof and seamless surface)
- only **282 g**
- L = 255 x W = 145 mm



251030 SATTEL ›FRITZ‹

16,90 €

- **Aluminium-Look**-Gestell mit **Skala**
- nur **282 g**
- L = 298 x B = 130 mm

SADDLE ›FRITZ‹

- **aluminium look** rails with **scale**
- only **282 g**
- L = 298 x W = 130 mm



ART.-NR. UVP **BESCHREIBUNG**

DESCRIPTION

- **251011**
U
13,90 €
- **SATTEL ›COMP II‹**
- **Aluminium-Look-Gestell mit Skala**
- **V-Design**
- **"Base Cut"**
- nur 265 g
- L = 268 x B = 134 mm

- **SADDLE ›COMP II‹**
- **aluminium look rails with scale**
- **V-Design**
- **"Base Cut"**
- only 265 g
- L = 268 x W = 134 mm



- **250155**
U
13,90 €
- **SATTEL ›COMP V‹**
- Gestell mit **Skala**
- **„Full-Cut“**
- nur 297 g
- L = 270 x B = 140 mm

- **SADDLE ›COMP V‹**
- rails with **scale**
- **„Full-Cut“**
- only 297 g
- L = 270 x W = 140 mm



- **251015**
U
14,90 €
- **SATTEL ›COMP IV‹**
- **Aluminium-Look-Gestell mit Skala**
- **V-Design**
- hinterer und seitlicher **Abriebschutz**
- nur 336 g
- L = 270 x B = 155 mm

- **SADDLE ›COMP IV‹**
- **aluminium look rails with scale**
- **V-Design**
- rear and side **abrasion protection**
- only 336 g
- L = 270 x W = 155 mm



- **251013**
U
13,90 €
- **SATTEL ›COMP VI‹**
- **Aluminium-Look-Gestell mit Skala**
- **V-Design**
- **"Full-Cut"**
- **besonders hochwertige und stabile Sattelschale**
- nur 347 g
- L = 270 x B = 152 mm

- **SADDLE ›COMP VI‹**
- **aluminium look rails with scale**
- **V-Design**
- **"Full-Cut"**
- **stable base of high quality**
- only 347 g
- L = 270 x W = 152 mm



ART.-NR. UVP **BESCHREIBUNG**

DESCRIPTION

- **251012** **SATTEL ›COMP X‹**
U
11,90 €
 - **Aluminium-Look**-Gestell mit **Skala**
 - **V-Design**
 - **"Full-Cut"**
 - nur 286 g
 - L = 270 x B = 139 mm

- **SADDLE ›COMP X‹**
 - **aluminium look rails with scale**
 - **V-Design**
 - **"Full-Cut"**
 - only 286 g
 - L = 270 x W = 139 mm



TOUR

TOUR

- **251016** **SATTEL ›TOUR II‹**
U
14,90 €
 - Gestell mit **Skala**
 - **"Full-Cut"**
 - mit **"Deep Channel"** Luftkühlung
 - hinterer und seitlicher **Abriebschutz**
 - nur 391 g
 - L = 262 x B = 156 mm



- **SADDLE ›TOUR II‹**
 - rails with **scale**
 - **"Full-Cut"**
 - with **"Deep Channel"** air cooling
 - rear and side **abrasion protection**
 - only 391 g
 - L = 262 x W = 156 mm



- **SATTEL ›VACU TOUR IV‹**
 - Gestell mit **Skala**
 - **"Full-Cut"**
 - **gefederter Stützpunkt**
 - mit **Luftkanal** hinten
 - L = 260 x B = 186 mm

- **SADDLE ›VACU TOUR IV‹**
 - rails with **scale**
 - **"Full-Cut"**
 - **rail suspension**
 - with rear **air channel**
 - L = 260 x W = 186 mm

- **251019** **SATTEL ›VACU TOUR IV‹**
U
17,90 €
 - schwarz
 - besonders **weicher Vakuum-Sattel** mit nahtloser Oberfläche
 - nur 451 g

- **SADDLE ›VACU TOUR IV‹**
 - black
 - extra **soft vacuum saddle** with seamless cover
 - only 451 g



- **251020** **SATTEL ›VACU TOUR IV‹**
U
17,90 €
 - braun
 - mit hinterem Abriebschutz
 - nur 440 g

- **SADDLE ›VACU TOUR IV‹**
 - brown
 - rear abrasion protection
 - only 440 g



ART.-NR. BESCHREIBUNG
UVP

DESCRIPTION

CITY

CITY

CITY

• 251037 SATTEL ›VACU CITY II‹

SADDLE ›VACU CITY II‹

17,90 €



- schwarzes Gestell mit **Skala**
- **wasserdicht durch Vakuum-Technologie** (verschweißte, wasserdichte und nahtlose Oberfläche)
- nur 464 g
- L = 260 x B = 210 mm

- black rails with **scale**
- **waterproof** because of **vacuum technology** (welded, waterproof and seamless surface)
- only 464 g
- L = 260 x W = 210 mm



SATTEL ›VACU CITY‹

SADDLE ›VACU CITY‹

- schwarzes Gestell mit **Skala**
- **wasserdicht durch Vakuum-Technologie** (verschweißte, wasserdichte und nahtlose Oberfläche)

- black rails with **scale**
- **waterproof** because of **vacuum technology** (welded, waterproof and seamless surface)

• 251029 Größe S

size S

14,90 €



- nur 329 g
- L = 275 x B = 156 mm

- only 329 g
- L = 275 x W = 156 mm



251071 Vacu City M

Vacu City M

15,90 €



- **Größe M**
- nur 359 g
- L = 265 x B = 165 mm

- **size M**
- only 359 g
- L = 265 x W = 165 mm



• 251039 Größe L

size L

15,90 €



- nur 415 g
- L = 268 x B = 190 mm

- only 415 g
- L = 268 x W = 190 mm



ART.-NR. BESCHREIBUNG
UVP

DESCRIPTION

- **251028 Größe XL**
 - nur 459 g
 - L = 257 x B = 211 mm

- **size XL**
 - only 459 g
 - L = 257 x W = 211 mm

17,90 €
XL



- **251072 Größe XL**
 - mit **Griff**
 - nur 505 g
 - L = 254 x B = 209 mm

- **size XL**
 - with **handle**
 - only 505 g
 - L = 254 x W = 209 mm

22,90 €
XL



- **251073 Größe XL**
 - mit **Elastomer-Federung**
 - sportliche Ausführung
 - nur 673 g
 - L = 253 x B = 221 mm

- **size XL**
 - with **elastomer suspension**
 - sporty version
 - only 673 g
 - L = 253 x W = 221 mm

24,90 €
XL



- **251051 Größe XL**
 - mit **Elastomer-Federung**
 - nur 698 g
 - L = 261 x B = 223 mm

- **size XL**
 - with **elastomer suspension**
 - only 698 g
 - L = 261 x W = 223 mm

22,90 €
XL



ART.-NR. UVP **BESCHREIBUNG**

DESCRIPTION

251023 **SATTEL ›ELAST - XXL CITY‹**
 U
 26,90 €
XXL
120 kg
 • schwarzes Gestell mit **Skala**
 • mit **Elastomer**-Federung
 • hinterer und seitlicher **Abriebschutz**
 • mit **Sattelstützklemme**
 • nur 986 g
 • L = 291 x B = 276 mm

SADDLE ›ELAST - XXL CITY‹
 • black rails with **scale**
 • with **elastomer** suspension
 • rear and side **abrasion protection**
 • with **clamp** for seat post
 • only 986 g
 • L = 291 x W = 276 mm



SATTEL ›ELAST - CITY‹

- **Elastomer-Federung**
- vorderer und hinterer Abriebschutz
- schwarzes Gestell mit Skala

SADDLE ›ELAST - CITY‹

- **elastomer suspension**
- front and rear abrasion protection
- black rails with scale



251034 **Größe M**
 L = 260 mm x B = 185 mm
M

size M
 L = 260 mm x W = 185 mm

251027 **Größe L**
 U
 21,90 €
L
 L = 265 mm x B = 200 mm

size L
 L = 265 mm x W = 200 mm

braune **Echtlederoptik**

brown **genuine leather appearance**

251022 **Größe L**
 L = 265 mm x B = 200 mm
L

size L
 L = 265 mm x W = 200 mm



251060 **SATTEL ›EVA CITY‹**
 18,90 €
 • sehr weicher **EVA**-Sattel
 • sehr **umweltfreundliches** Obermaterial
 • robuste Oberfläche
 • nur 448 g
 • L = 262 x B = 216 mm

SADDLE ›EVA CITY‹
 • very soft **EVA**-saddle
 • very **environmentally friendly** upper material
 • robust surface
 • only 448 g
 • L = 262 x W = 216 mm



ART.-NR. UVP	BESCHREIBUNG	DESCRIPTION	
251021 12,90 €	SATTEL ›CITY SPRING‹ <ul style="list-style-type: none"> • schwarzes Gestell • mit Federn • mit Sattelstützklemme • nur 625 g • L = 235 x B = 205 mm 	SADDLE ›CITY SPRING‹ <ul style="list-style-type: none"> • black rails • with springs • with clamp for seat post • only 625 g • L = 235 x W = 205 mm 	

YOUTH / CHILD **YOUTH / CHILD**

251049 10,90 €	SATTEL ›TEEN TWO‹ <ul style="list-style-type: none"> • für 24" (20" - 26") • "Base Cut" • vorderer und hinterer Abriebschutz • mit Sattelstützklemme • nur 493 g • L = 242 x B = 143 mm 	SADDLE ›TEEN TWO‹ <ul style="list-style-type: none"> • for 24" (20" - 26") • "Base Cut" • front and rear abrasion protection • with clamp for seat post • only 493 g • L = 242 x W = 143 mm 	
-------------------	--	--	--

251025 9,90 €	SATTEL ›TEEN‹ <ul style="list-style-type: none"> • für 20" (16" - 24") • mit Sattelstützklemme • nur 433 g • L = 216 x B = 168 mm 	SADDLE ›TEEN‹ <ul style="list-style-type: none"> • for 20" (16" - 24") • with clamp for seat post • only 433 g • L = 216 x W = 168 mm 	
------------------	---	---	---

251032 8,90 €	SATTEL ›KID GRIP‹ <ul style="list-style-type: none"> • für 12" - 16" • integrierter Trage- und Haltegriff • mit Sattelstützklemme • 360° Abriebschutz • nur 398 g • L = 207 x B = 135 mm 	SADDLE ›KID GRIP‹ <ul style="list-style-type: none"> • for 12" - 16" • integrated handle for carrying • with clamp for seat post • 360° abrasion protection • only 398 g • L = 207 x W = 135 mm 	
------------------	---	---	---

Tested by the manufacturer according to ISO 4210

ART.-NR. UVP **BESCHREIBUNG**

DESCRIPTION

SATTELKLEMME MIT GEPÄCKTRÄGERBEFESTIGUNG ›RACKY‹

- **Aluminium**
- nur 36 g (Ø 31,8 mm)
- mit **Gewindeösen** für die **Gepäckträgerbefestigung**
- auf M-Wave Eurolochkarte

SEAT TUBE CLAMP WITH LUGGAGE CARRIER FIXATION ›RACKY‹

- **aluminium**
- only 36 g (Ø 31.8 mm)
- with **threads** for **luggage carrier fixation**
- on M-Wave eurohole card



250848 Ø 28,6 mm
U

Ø 28.6 mm

250850 Ø 31,8 mm
U

Ø 31.8 mm

250851 Ø 34,9 mm
U
8,90 €

Ø 34.9 mm



SATTELKLEMME ›CLAMPY QR‹

- mit **Schnellspanner**
- Aluminium
- auf **M-Wave Eurolochkarte**

SEAT TUBE CLAMP ›CLAMPY QR‹

- with **QR**
- aluminium
- on **M-Wave eurohole card**



Ø 31,8 mm

Ø 31.8 mm

250986 schwarz eloxiert

black anodised

250988 silber eloxiert

silver anodised

Ø 34,9 mm

Ø 34.9 mm

250987 schwarz eloxiert

black anodised

250941 silber eloxiert

silver anodised

4,90 €



SATTELKLEMME ›CLAMPY‹

- Aluminium
- auf **M-Wave Eurolochkarte**

SEAT TUBE CLAMP ›CLAMPY‹

- aluminium
- aluminium
- on **M-Wave eurohole card**

Ø 31,8 mm

Ø 31.8 mm

250938 schwarz eloxiert

black anodised

250939 silber eloxiert

silver anodised

Ø 34,9 mm

Ø 34.9 mm

250960 schwarz eloxiert

black anodised

250961 silber eloxiert

silver anodised

3,90 €



ART.-NR. BESCHREIBUNG
UVP

DESCRIPTION

GEFEDERTE SATTELSTÜTZEN

SUSPENSION SEAT POSTS

HÖHENVERSTELLBARE SATTELSTÜTZE ›LEVITATE C‹

- Aluminium
- **pneumatische Schnellhöhenverstellung** während der Fahrt durch einen **Hebel am Lenker**
- **leichtgängige, stufenlose Höhenverstellung**
- mit Skala
- Fahrergewicht bis **120 kg**
- in M-Wave Eurolochbox

DROPPER SEAT POST ›LEVITATE C‹

- aluminium
- **pneumatic quick release height adjustment** while riding by a **handlebar lever**
- **easy going, stepless height adjustment**
- with scale
- rider's weight up to **120 kg**
- in M-Wave eurohole box

252230 • Ø 27,2 mm
• Länge: 390 mm
• Höhenverstellung: **0 - 105 mm**

• Ø 27.2 mm
• length: 390 mm
• height adjustment: **0 - 105 mm**

• Länge: 400 mm
• Höhenverstellung: **0 - 125 mm**

• length: 400 mm
• height adjustment: **0 - 125 mm**

252231 Ø 30,9 mm

Ø 30.9 mm

252232 Ø 31,6 mm

Ø 31.6 mm

225,00 €



Tested by the manufacturer based on ISO 4210

HÖHENVERSTELLBARE SATTELSTÜTZE ›LEVITATE IN 125‹

- aufgeräumte Zugverlegung durch **integrierte Kabelführung**
- Aluminium
- **pneumatische, stufenlose Schnellhöhenverstellung** während der Fahrt durch einen **Hebel am Lenker**
- mit Skala
- Länge **420 mm**
- Höhenverstellung **0 - 125 mm**
- in M-Wave Eurolochbox

DROPPER SEAT POST ›LEVITATE IN 125‹

- clean look through **integrated cable routing**
- aluminium
- **pneumatic quick release, stepless height adjustment** while riding by a **handlebar lever**
- with scale
- length **420 mm**
- height adjustment **0 - 125 mm**
- in M-Wave eurohole box

252200 Ø 30,9 mm

Ø 30.9 mm

252202 Ø 31,6 mm

Ø 31.6 mm

236,90 €



ART.-NR. BESCHREIBUNG
UVP

DESCRIPTION



(Ø 30,9 mm)



(Ø 31,6 mm)

HÖHENVERSTELLBARE SATTELSTÜTZE ›LEVITATE IN LT‹

- aufgeräumte Zugverlegung durch **integrierte Kabelführung**
- Aluminium
- **pneumatische, stufenlose Schnellhöhenverstellung** während der Fahrt durch einen **Hebel am Lenker**, mit Edelstahlkabel
- mit Skala

- Länge **440 mm**
- Höhenverstellung **0 - 150 mm**

DROPPER SEAT POST ›LEVITATE IN LT‹

- clean look through **integrated cable routing**
- aluminium
- **pneumatic quick release, stepless height adjustment** while riding by a **handlebar lever**, with stainless steel cable
- with scale

- length **440 mm**
- height adjustment **0 - 150 mm**

252220 Ø 30,9 mm, in M-Wave Eurolochbox

Ø 30.9 mm, in M-Wave eurohole box

252222 Ø 31,6 mm, in M-Wave Eurolochbox

Ø 31.6 mm, in M-Wave eurohole box

252224 Ø 30,9 mm, Montageverpackung

Ø 30.9 mm, OEM

252226 Ø 31,6 mm, Montageverpackung

Ø 31.6 mm, OEM

- Länge **480 mm**
- Höhenverstellung **0 - 170 mm**

- length **480 mm**
- height adjustment **0 - 170 mm**

252221 Ø 30,9 mm, in M-Wave Eurolochbox

Ø 30.9 mm, in M-Wave eurohole box

252223 Ø 31,6 mm, in M-Wave Eurolochbox

Ø 31.6 mm, in M-Wave eurohole box

252225 Ø 30,9 mm, Montageverpackung

Ø 30.9 mm, OEM

252227 Ø 31,6 mm, Montageverpackung

Ø 31.6 mm, OEM

209,00 €

Tested by the manufacturer based on ISO 4210



HÖHENVERSTELLBARE SATTELSTÜTZE ›LEVITATE EX 125‹

- Aluminium
- **pneumatische Schnellhöhenverstellung** während der Fahrt durch **einen Hebel am Lenker**
- **leichtgängige, stufenlose Höhenverstellung: 0 - 125 mm**
- mit Skala
- Fahrergewicht bis **120 kg**
- Länge: 475 mm
- in M-Wave Eurolochbox

DROPPER SEAT POST ›LEVITATE EX 125‹

- aluminium
- **pneumatic quick release height adjustment** while riding by a **handlebar lever**
- **easy going, stepless height adjustment: 0 - 125 mm**
- with scale
- rider's weight up to **120 kg**
- length: 475 mm
- in M-Wave eurohole box

252240 Ø 30,9 mm

Ø 30.9 mm



252241 Ø 31,6 mm

Ø 31.6 mm

179,00 €



Tested by the manufacturer based on ISO 4210

ART.-NR. UVP	BESCHREIBUNG	DESCRIPTION	
	<p>HÖHENVERSTELLBARE SATTELSTÜTZE ›LEVITATE IN 2‹</p> <ul style="list-style-type: none"> • aufgeräumte Zugverlegung durch integrierte Kabelführung • Aluminium • hydraulische Schnellhöhenverstellung während der Fahrt durch einen Hebel am Lenker • mit Skala • Montageverpackung 	<p>DROPPER SEAT POST ›LEVITATE IN 2‹</p> <ul style="list-style-type: none"> • clean look through integrated cable routing • aluminium • hydraulic quick release height adjustment while riding by a handlebar lever • with scale • OEM 	
<p>252213</p> <ul style="list-style-type: none"> • Ø 27,2 mm • Länge: 373 mm • Höhenverstellung: 0 - 100 mm 	<ul style="list-style-type: none"> • Ø 27.2 mm • length: 373 mm • height adjustment: 0 - 100 mm 	<ul style="list-style-type: none"> • length: 426 mm • height adjustment: 0 - 125 mm 	
	<p></p> <ul style="list-style-type: none"> • Länge: 426 mm • Höhenverstellung: 0 - 125 mm 	<ul style="list-style-type: none"> • length: 426 mm • height adjustment: 0 - 125 mm 	<p>Tested by the manufacturer based on ISO 4210</p>
<p>252214</p> <p>Ø 30,9 mm</p>		<p>Ø 30.9 mm</p>	
<p>252215</p> <p>Ø 31,6 mm</p> <p>139,00 €</p>		<p>Ø 31.6 mm</p>	

	<p>HÖHENVERSTELLBARE SATTELSTÜTZE ›SP110-ADJ‹</p> <ul style="list-style-type: none"> • Aluminium • Schnellhöhenverstellung während der Fahrt durch Hebel am Lenker • 3 Höhenstufen: 0/45/110 mm • Länge 445 mm • mit Skala <p>auf M-Wave Eurolochkarte</p>	<p>DROPPER SEAT POST ›SP110-ADJ‹</p> <ul style="list-style-type: none"> • aluminium • quick release hight adjustment while riding by a handlebar lever • 3 height steps: 0/45/110 mm • length 445 mm • with scale <p>on M-Wave eurohole card</p>	
<p>252147</p> <p>Ø 27,2 mm</p>		<p>Ø 27.2 mm</p>	
<p>252155</p> <p>Ø 31,6 mm</p>		<p>Ø 31.6 mm</p>	
	<p>Montageverpackung</p>	<p>OEM</p>	
<p>252148</p> <p>Ø 27,2 mm</p>		<p>Ø 27.2 mm</p>	
<p>252156</p> <p>Ø 31,6 mm</p> <p>119,00 €</p>		<p>Ø 31.6 mm</p>	



ART.-NR. UVP **BESCHREIBUNG**

DESCRIPTION



GEFEDERTE PARALLELOGRAMMSATTELSTÜTZE ›FOURSPRING‹

- **einteiliges Aluminiumrohr** mit **Design-Schutzabdeckung**
- **hervorragendes Ansprechverhalten** durch Parallelogrammverschiebung (kein Verkanten)
- Vorspannung einstellbar
- 2-Punkt Befestigung des Sattelgestells, mit **Winkelskala**
- Federweg: **36 mm** im Kreisbogen
- Länge 350 mm
- mit Skala (Höheneinstellung)
- mit Originalfeder empfohlen bis 85 kg
- optional durch Austausch-Federn (Art. 252178, 252165, 252179) für anderes Fahrergewicht anpassbar

PARALLELOGRAM SUSPENSION SEAT POST ›FOURSPRING‹

- **one-piece aluminium tube** with **design protective cover**
- **very sensitive response characteristic** through parallelogram movement (no tilting)
- preload adjustable
- 2-point fixation of the saddle rails, with **angular scale**
- travel: **36 mm** in a circular arc
- length 350 mm
- with scale (height adjustment)
- with original replacement springs recommended up to 85 kg
- optionally convertible to another driver's weight by replacement springs (art. 252178, 252165, 252179)



auf M-Wave Eurolochkarte

on M-Wave eurohole card

252176 Ø 27,2 mm
U

Ø 27.2 mm

252197 Ø 30,9 mm
U

Ø 30.9 mm

252177 Ø 31,6 mm
U

Ø 31.6 mm

Montageverpackung

OEM

252180 Ø 27,2 mm

Ø 27.2 mm

252182 Ø 30,9 mm

Ø 30.9 mm

252181 Ø 31,6 mm
125,90 €

Ø 31.6 mm

0-120 kg

ERSATZ-/TUNING-FEDER

REPLACEMENT-/ TUNING-SPRING

- zum Umbau der Sattelstützen Art. 252180-2 für ein anderes Fahrergewicht
- im Polybeutel mit Aufkleber

- for converting seat post art. 252180-2 to another rider's weight
- in PE bag with sticker

252178 0 - 70 kg, silber
U

0 - 70 kg, silver

252165 85 - 100 kg, schwarz
U

85 - 100 kg, black

252179 100 - 120 kg, grün
U
8,90 €

100 - 120 kg, green



ART.-NR. UVP	BESCHREIBUNG	DESCRIPTION
	PARALLELOGRAMM-SATTELSTÜTZE ›FOURSPRING VARIO‹ <ul style="list-style-type: none"> • einteiliges Aluminiumrohr • hervorragendes Ansprechverhalten durch Parallelogrammverschiebung (kein Verkanten) • schnelle und einfache De-/Montage des Sattels • Vorspannung einstellbar • Federweg 20 mm im Kreisbogen • Länge 350 mm • mit Skala • für Fahrergewicht 70 bis 90 kg empfohlen • optional durch Austausch-Federn (Art. 252187, 252199) für anderes Fahrergewicht anpassbar 	PARALLELOGRAM SEAT POST ›FOURSPRING VARIO‹ <ul style="list-style-type: none"> • one-piece aluminium tube • very sensitive response characteristic through parallelogram movement (no tilting) • quick and easy dismantling and assembly of the saddle • preload adjustable • circular travel 20 mm • length 350 mm • with scale • recommended for drivers weight 70 to 90 kg • optionally convertible to another driver's weight by replacement springs (art. 252187, 252199)
	auf M-Wave Eurolochkarte	on M-Wave Eurohole card
	252183 Ø 27,2 mm 252196 Ø 30,9 mm 252184 Ø 31,6 mm	on M-Wave Eurohole card Ø 27.2 mm Ø 30.9 mm Ø 31.6 mm
	Montageverpackung • 252185 Ø 27,2 mm • 252194 Ø 30,9 mm • 252186 Ø 31,6 mm 94,90 €	OEM Ø 27.2 mm Ø 30.9 mm Ø 31.6 mm



Tested by the manufacturer based on ISO 4210

	ERSATZ-/TUNING-FEDER zum Umbau der Sattelstützen Art. 252185/86/94 für ein anderes Fahrergewicht	REPLACEMENT-/ TUNING-SPRING for converting seat post art. 252185/ 86/94 to another rider's weight
	252187 50 - 90 kg, silber 252199 90 - 120 kg, schwarz 5,90 €	50 - 90 kg, silver 90 - 120 kg, black



252198 7,90 €	NEOPRENSCHUTZCOVER FÜR PARALLELOGRAM-SATTELSTÜTZEN ›FOURSPRING COVER‹ <ul style="list-style-type: none"> • schützt vor eingeklemmten Fingern, Witterungsschäden und Schmutz • mit universellem Klettverschluss • mit reflektierendem Material • passend für Art. 252183ff., ... • auf M-Wave Eurolochkarte 	NEOPRENE PROTECTION COVER FOR PARALLELOGRAM SEAT-POSTS ›FOURSPRING COVER‹ <ul style="list-style-type: none"> • protects from pinched fingers, weather damage and dirt • with universal hook and loop fastener • with reflective material • suitable for art. 252183 et seq., ... • on M-Wave eurole card
		

ART.-NR. UVP **BESCHREIBUNG**

DESCRIPTION



GEFEDERTE SATTELSTÜTZE
›SP-C3‹

- Aluminium
- **Spiel einstellbar**
- Länge 350 mm
- Federweg 40 mm
- Offset: 8 mm
- Vorspannung einstellbar
- mit Skala

SUSPENSION SEAT POST
›SP-C3‹

- aluminium
- **tolerance adjustable**
- length 350 mm
- 40 mm travel
- offset: 8 mm
- preload adjustable
- with scale

auf M-Wave Eurolochkarte

on M-Wave eurohole card

- 252324** U Ø 27,2 mm
- 252325** U Ø 30,9 mm
- 252326** U Ø 31,6 mm

- Ø 27.2 mm
- Ø 30.9 mm
- Ø 31.6 mm

Montageverpackung

OEM

- 252327** Ø 27,2 mm
- 252328** Ø 30,9 mm
- 252329** Ø 31,6 mm

- Ø 27.2 mm
- Ø 30.9 mm
- Ø 31.6 mm

28,90 €

Tested by the manufacturer based on ISO 4210



GEFEDERTE SATTELSTÜTZE

SUSPENSION SEAT POST

- Aluminium
- Länge 315 mm
- Federweg **40 mm**
- **Vorspannung einstellbar**
- Montageverpackung

- aluminium
- length 315 mm
- **40 mm travel**
- **preload adjustable**
- OEM

- **252122** Ø 25,4 mm
 - **252123** Ø 27,2 mm
- 16,90 €

- Ø 25.4 mm
- Ø 27.2 mm



GEFEDERTE SATTELSTÜTZE

SUSPENSION SEAT POST

- Aluminium
- Federweg **40 mm**
- **Vorspannung einstellbar**
- Montageverpackung

- aluminium
- **40 mm travel**
- **preload adjustable**
- OEM

- Länge 315 mm
 - **252115** U Ø 25,4 mm
 - **252116** U Ø 27,2 mm
- 15,90 €

- length 315 mm
- Ø 25.4 mm
- Ø 27.2 mm

Länge 300 mm, ohne Logo

length 300 mm, without logo

- 252129** Ø 27,2 mm
- 16,90 €

- Ø 27.2 mm



GEFEDERTE KERZEN-SATTELSTÜTZE

SUSPENSION SEAT POST

- **Aluminium**
- **Vorspannung einstellbar**
- Länge 300 mm
- Federweg **40 mm**
- Montageverpackung

- **aluminium**
- **preload adjustable**
- length 300 mm
- **40 mm travel**
- OEM



- **252058** U Ø 25,4 mm
 - **252059** U Ø 27,2 mm
- 13,90 €

- Ø 25.4 mm
- Ø 27.2 mm



ART.-NR. UVP	BESCHREIBUNG	DESCRIPTION
252195 U 29,90 € 	SATTELSTÜTZE ›RAPID SWAP‹ <ul style="list-style-type: none"> • schneller Sattelwechsel durch Schnellspanner • ideal zum Testen verschiedener Sättel, Verleihräder, ... • Aluminium • Länge 350 mm • Ø 27,2 mm (Adapter für andere Durchmesser auf Seite 136) • auf M-Wave Eurolochkarte 	SEAT POST ›RAPID SWAP‹ <ul style="list-style-type: none"> • quick saddle change by QR • ideal for testing of various saddles, rental bikes, ... • aluminium • length 350 mm • Ø 27.2 mm (adapters for various diameters on page 136) • on M-Wave eurohole card



 (Ø 31,6 mm)	SATTELSTÜTZE ›A 350 STRONG‹ <ul style="list-style-type: none"> • mit Aluminium-Kopf • einfache Sattelneigeinstellung durch 2-Schrauben-Einstellsystem • Offset: 15 mm • Länge 350 mm 	SEAT POST ›A 350 STRONG‹ <ul style="list-style-type: none"> • with aluminium head • easy saddle angle adjustable with 2 bolts • offset: 15 mm • length 350 mm
auf M-Wave Eurolochkarte	on M-Wave eurohole card	
252831 Ø 27,2 mm 252833 Ø 30,9 mm 252835 Ø 31,6 mm	Montageverpackung <ul style="list-style-type: none"> • 252830 Ø 27,2 mm • 252832 Ø 30,9 mm • 252834 Ø 31,6 mm 16,90 €	OEM <ul style="list-style-type: none"> Ø 27.2 mm Ø 30.9 mm Ø 31.6 mm

SATTELSTÜTZE <ul style="list-style-type: none"> • mit Aluminium-Kopf • Länge 350 mm • Montageverpackung 	SEAT POST <ul style="list-style-type: none"> • with aluminium head • length 350 mm • OEM
schwarz <ul style="list-style-type: none"> • 252426 Ø 25,4 mm • 252427 Ø 27,2 mm • 252428 Ø 28,6 mm 	black <ul style="list-style-type: none"> Ø 25.4 mm Ø 27.2 mm Ø 28.6 mm
silber <ul style="list-style-type: none"> • 252423 Ø 25,4 mm • 252425 Ø 27,2 mm 9,90 €	silver <ul style="list-style-type: none"> Ø 25.4 mm Ø 27.2 mm



Tested by the manufacturer based on ISO 4210

259891 36,90 €	KINDER-REGENPONCHO ›PONCHO KID´N´SEAT‹ <ul style="list-style-type: none"> • passend für alle gängigen Kindersitze • geeignet für Kinder von 6 Monaten bis 5 Jahren • mit Ärmeln für optimale Bewegungsfreiheit • auch zur Abdeckung des Kindersitzes geeignet • mit reflektierenden Elementen • im Polybeutel mit Euroloch 	RAIN COVER FOR CHILDREN SEAT ›PONCHO KID´N´SEAT‹ <ul style="list-style-type: none"> • suitable for all common child seats • suitable for children from 6 months to 5 years • with sleeves for optimal freedom of movement • also useable for covering the baby seat • with reflective elements • in PE bag with eurohole
--------------------------	---	---



ART.-NR. BESCHREIBUNG
UVP

DESCRIPTION

360°

FAHRRADSPIEGEL

- **3-dimensional verstellbar**
- **gestochen scharfes, entspiegeltes, schlagfestes und blendfreies Echtglas**
- sehr beständiges Gehäuse aus **Nylonfasern**
- Aluminiumschelle Ø 22,2 mm
- in M-Wave Eurolochbox

BICYCLE MIRROR

- **3-dimensionally adjustable**
- **high definition, antireflective, blast resistant and glare-free genuine glass**
- high impact **nylon fiber** frame
- aluminium clamp Ø 22.2 mm
- in M-Wave eurohole box



137 g

›**SPY SPACE**‹

sehr leicht, nur ca. **137 g**

›**SPY SPACE**‹

very light, only approx. **137 g**

270015

zur Montage an der **linken** Seite

U

for mounting at the **left** side

270016

zur Montage an der **rechten** Seite

U

22,90 €

for mounting at the **right** side

270019

›**SPY SPACE BAREND**‹

24,90 €

- **für Montage am linken Lenkerende**
- **sehr leicht, nur ca. 137 g**

›**SPY SPACE BAREND**‹

- for mounting on **left handlebar end**
- very light, only approx. **137 g**



141 g

270014

FAHRRADSPIEGEL

›**SPY SPACE IN XL**‹

24,90 €

360°

- **3-dimensional verstellbar**
- Montage links
- **gestochen scharfes, entspiegeltes, schlagfestes und blendfreies Echtglas**
- sehr beständiges Gehäuse aus **Nylonfasern**
- ca. Ø 80 mm Spiegelfläche
- passend für Ø 16-22 mm Lenkerinnendurchmesser
- auf M-Wave Eurolochkarte

BICYCLE MIRROR

›**SPY SPACE IN XL**‹

- **3-dimensionally adjustable**
- left side mounting
- **high definition, antireflective, blast resistant and glare-free genuine glass**
- high impact **nylon fiber** frame
- approx. Ø 80 mm mirror surface
- suitable for Ø 16-22 mm inner bar diameter
- on M-Wave eurohole card



270017

FAHRRADSPIEGEL

›**SPY SPACE IN**‹

U

21,90 €

360°

- **3-dimensional verstellbar**
- **universelle** Montage **rechts und links** möglich
- **gestochen scharfes, entspiegeltes, schlagfestes und blendfreies Echtglas**
- sehr beständiges Gehäuse aus **Nylonfasern**
- sehr stabile Befestigung, teilweise aus **Aluminium**
- für Lenker und Lenkerzusatzgriffe mit Ø 16 – 22 mm Innendurchmesser
- auf M-Wave Eurolochkarte

BICYCLE MIRROR

›**SPY SPACE IN**‹

- **3-dimensionally adjustable**
- **universal** mounting at **left and right side** possible
- **high definition, antireflective, blast resistant and glare-free genuine glass**
- high impact **nylon fiber** frame
- very stable mounting, partially made of **aluminium**
- for handlebars and bar ends with Ø 16 – 22 mm inner diameter
- on M-Wave eurohole card



270071

FAHRRADSPIEGEL

›**SPY SPACE 45 COMPACT**‹

32,90 €

- **ECE geprüft:** für alle Fahrzeuge der Klasse L, die keine den Fahrer umschließende Karosserie aufweisen, z. B. **geeignet für E-Bikes, S-Pedelecs** bis 45 km/h Maximalgeschwindigkeit, **Mofas, Motorräder, Quads, ...**
- **3-dimensional verstellbar**
- **gestochen scharfes, entspiegeltes, schlagfestes und blendfreies Echtglas**
- sehr beständiges Gehäuse aus **Nylonfasern**
- Aluminiumschelle Ø 22,2 mm
- nur 161 g
- in M-Wave Eurolochbox

BICYCLE MIRROR

›**SPY SPACE 45 COMPACT**‹

- **ECE approved:** for all class L vehicles which do not have a bodywork surrounding the driver, e. g. **suitable for E-Bikes, S-Pedelecs** up to 45 km/h maximum speed, **mopeds, motorcycles, quads, ...**
- **3-dimensionally adjustable**
- **high definition, antireflective, blast resistant and glare-free genuine glass**
- high impact **nylon fiber** frame
- aluminium clamp Ø 22.2 mm
- only 161 g
- in M-Wave eurohole box



ECE APPROVED

ART.-NR. UVP	BESCHREIBUNG	DESCRIPTION
-----------------	--------------	-------------

270070
U
21,90 €

FAHRRADSPIEGEL
›SPY SPACE 45‹



- **ECE geprüft:** für alle Fahrzeuge der Klasse L, die keine den Fahrer umschließende Karosserie aufweisen, z. B. **geeignet für E-Bikes, S-Pedelecs** bis 45 km/h Maximalgeschwindigkeit, **Mofas, Motorräder, Quads, ...**
- **3-dimensional verstellbar**
- **blendfreies Echtglas**
- zur Montage am Lenkerende mit Innen-Ø 14,5 - 16,5 mm und Ø 18 - 19,5 mm
- in M-Wave Blisterverpackung

BICYCLE MIRROR
›SPY SPACE 45‹

- **ECE approved:** for all class L vehicles which do not have a bodywork surrounding the driver, e. g. **suitable for E-Bikes, S-Pedelecs** up to 45 km/h maximum speed, **mopeds, motorcycles, quads, ...**
- **3-dimensionally adjustable**
- **glare-free genuine glass**
- for mounting on handlebar ends with inner-Ø 14.5 - 16.5 mm and Ø 18 - 19.5 mm
- in M-Wave blister packaging



ECE APPROVED

270060
U
14,90 €

FAHRRADSPIEGEL
›SPY FLEX‹



- **mit flexiblem Schwanenhals** zum schnellen Drehen oder Verstellen
- **3-dimensional verstellbarer Konvexspiegel**
- Gesamtlänge ca. 315 mm
- ca. Ø 70 mm Spiegelfläche
- Klemmschelle Ø 21 - 30 mm
- auf M-Wave Eurolochkarte

BICYCLE MIRROR
›SPY FLEX‹

- **with flexible rod** for quick turning or adjustment
- **3-dimensionally adjustable convex mirror**
- total length approx. 315 mm
- approx. Ø 70 mm mirror surface
- clamp Ø 21 - 30 mm
- on M-Wave eurohole card



270061
U
14,90 €

FAHRRADSPIEGEL
›SPY FLEX TF‹



- **mit flexiblem Schwanenhals** zum schnellen Drehen oder Verstellen
- **3-dimensional verstellbarer Konvexspiegel**
- Gesamtlänge ca. 375 mm
- ca. Ø 80 mm Spiegelfläche
- **werkzeuglose Montage** mit Ø 21 - 30 mm Klemme
- auf M-Wave Eurolochkarte

BICYCLE MIRROR
›SPY FLEX TF‹

- **with flexible rod** for quick turning or adjustment
- **3-dimensionally adjustable convex mirror**
- total length approx. 375 mm
- approx. Ø 80 mm mirror surface
- **toolless mounting** with clamp for Ø 21 - 30 mm
- on M-Wave eurohole card



270080
U
10,90 €

FAHRRADSPIEGEL
›SPY BASE‹



- **3-dimensional verstellbar**
- variable Einstellmöglichkeiten
- **konvexe und blendfreie** Spiegelfläche (ca. 105 x 70 mm)
- **superleicht, nur 99 g**
- Klemmschelle Ø 22,2 mm, ohne Demontage von Griff, ... montierbar
- Länge: ca. 300 mm
- auf M-Wave Eurolochkarte

BICYCLE MIRROR
›SPY BASE‹

- **3-dimensionally adjustable**
- variable adjustment possibilities
- **convex and glare-free** mirror surface (approx. 105 x 70 mm)
- **super light, only 99 g**
- clamp Ø 22.2 mm, mountable without demounting of grip, ...
- length: approx. 300 mm
- on M-Wave eurohole card



ART.-NR. UVP **BESCHREIBUNG**

DESCRIPTION

360°

FAHRRADSPIEGEL

- universeller, **3-dimensional verstellbarer Konvexspiegel**
- ca. Ø 46 mm
- **universeller** Gummizughalter zur **werkzeuglosen Montage** am Lenker, Vorbau, Lenkerzusatzgriff, Rahmen, ...
- auf M-Wave Eurolochkarte



BICYCLE MIRROR

- universal, **3-dimensionally adjustable convex mirror**
- approx. Ø 46 mm
- **universal** rubber bracket for **toolless mounting** on handlebar, handle stem, bar end, frame, ...
- on M-Wave eurohole card



270028 ›SPY MINI‹
U
9,90 €

›SPY MINI‹

270034 ›SPY MINI SHORT‹
U
7,90 €

›SPY MINI SHORT‹

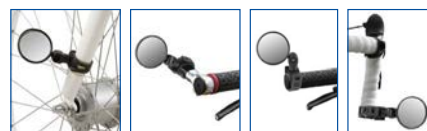

270020 **FAHRRADSPIEGEL** ›SPY MAXI‹
U
7,90 €

360°

- **3-dimensional verstellbarer Konvexspiegel**
- ca. Ø 76 mm
- für Montage am Lenkerende oder Lenkerzusatzgriff
- auf M-Wave Eurolochkarte

BICYCLE MIRROR ›SPY MAXI‹

- **3-dimensionally adjustable convex mirror**
- approx. Ø 76 mm
- for mounting on handlebar end or bar end
- on M-Wave eurohole card



270029 **FAHRRADSPIEGEL** ›SPY MICRO‹
U
7,90 €

360°

- universeller, **3-dimensional verstellbarer Konvexspiegel**
- ca. Ø 35 mm
- für Montage am Lenkerende oder Lenkerzusatzgriff
- **werkzeuglos montierbar**
- schwarz
- auf M-Wave Eurolochkarte



BICYCLE MIRROR ›SPY MICRO‹

- universal, **3-dimensionally adjustable convex mirror**
- approx. Ø 35 mm
- for mounting on handlebar end or bar end
- **toolless mounting**
- black
- on M-Wave eurohole card



270032 **FAHRRADSPIEGEL** ›SPY OVAL‹
U
6,90 €

360°

- **3-dimensional** verstellbar
- für **werkzeuglose Montage** am Lenkerende oder Lenkerzusatzgriff
- mit **2 Haltern** für unterschiedliche Lenkerdurchmesser
- ca. 75 x 50 mm
- schwarz
- auf M-Wave Eurolochkarte



BICYCLE MIRROR ›SPY OVAL‹

- **3-dimensionally** adjustable
- for **toolless mounting** on handlebar end or bar end
- with **2 holders** for different handlebar diameters
- approx. 75 x 50 mm
- black
- on M-Wave eurohole card



ART.-NR. UVP
BESCHREIBUNG

DESCRIPTION

M-WAVE E-BIKE KETTEN

Mit den neuen E-Bike Ketten für 1-11-fach Systeme schafft es M-Wave, haltbare und bezahlbare Ketten zu realisieren.

Aber damit nicht genug: Spezielle E-Bike-Ketten für den harten Einsatz gibt es auch und werden durch die Zertifizierung in Kategorie 4 bis 140 kg auch garantiert. Natürlich sind sie für alle gängigen E-Motoren geeignet.

Auch neu im Programm: ein komplettes Sortiment von Antirost-Ketten, die für alle Schaltsysteme von Singlespeed bis 11-fach passen.

M-WAVE E-BIKE KETTEN

With the new e-bike chains for 1-11 speed systems, M-Wave manages to create durable and affordable e-bike chains.

But that's not all: There are also special e-bike chains for tough use and are guaranteed by certification in category 4 up to 140 kg. Of course, they are suitable for all common e-bike engines.

Also new in the assortment: a complete range of anti rust chains that fit all gear systems from single speed to 11 speed.



›ELEVEN SPEED‹

- für **11-fach** Schaltungssysteme
- 1/2" x 11/128"
- 116 Glieder
- mit Verschlussglied
- im M-Wave Einzelkarton

›ELEVEN SPEED‹

- for **11 speed**
- 1/2" x 11/128"
- 116 links
- with connecting link
- in M-Wave box

301941

U
41,90 €



›Elevenspeed E‹

- besonders geeignet für **E-Bikes**
- **längere Haltbarkeit** durch Verstärkungen
- für **Brose, Bosch, Shimano, Bafang, ...** Antriebe
- grau

›Elevenspeed E‹

- particularly suitable for **e-bikes**
- **longer durability** due to reinforcements
- for **Brose, Bosch, Shimano, Bafang, ...** drives
- grey



301911

U
39,90 €

›Elevenspeed AR‹

- mit **Antirost-Beschichtung**
- kompatibel zu **Shimano / Sram / Campagnolo**
- silber

›Elevenspeed AR‹

- with **anti rust coating**
- compatible with **Shimano / Sram / Campagnolo**
- silver



301906

U
26,90 €

›Elevenspeed‹

- kompatibel zu **Shimano / Sram / Campagnolo**
- dunkelgrau

›Elevenspeed‹

- compatible with **Shimano / Sram / Campagnolo**
- dark grey



›TENSPEED‹

- für **10-fach** Schaltungssysteme
- 1/2" x 11/128"
- 116 Glieder
- mit Verschlussglied
- im M-Wave Einzelkarton

›TENSPEED‹

- for **10 speed**
- 1/2" x 11/128"
- 116 links
- with connecting link
- in M-Wave box

301940

U
37,90 €



›Tenspeed E‹

- besonders geeignet für **E-Bikes**
- **längere Haltbarkeit** durch Verstärkungen
- für **Brose, Bosch, Shimano, Bafang, ...** Antriebe
- grau

›Tenspeed E‹

- particularly suitable for **e-bikes**
- **longer durability** due to reinforcements
- for **Brose, Bosch, Shimano, Bafang, ...** drives
- grey



301910

U
37,90 €

›Tenspeed AR‹

- mit **Antirost-Beschichtung**
- kompatibel zu **Shimano / Sram / Campagnolo**
- silber

›Tenspeed AR‹

- with **anti rust coating**
- compatible with **Shimano / Sram / Campagnolo**
- silver



301901

U
26,90 €

›Tenspeed‹

- kompatibel zu **Shimano / Sram / Campagnolo**
- nur **259 g** (110 Gl.)
- dunkelgrau

›Tenspeed‹

- compatible with **Shimano / Sram / Campagnolo**
- only **259 g** (110 li.)
- dark grey



ART.-NR. UVP	BESCHREIBUNG	DESCRIPTION
-----------------	--------------	-------------



›NINESPEED‹

- für **9-fach** Schaltungssysteme
- 1/2" x 11/128"
- 116 Glieder
- mit Verschlussglied
- im M-Wave Einzelkarton

›NINESPEED‹

- for **9 speed**
- 1/2" x 11/128"
- 116 links
- with connecting link
- in M-Wave box

301909
U
29,90 €

›Ninespeed AR‹

- mit **Antirost-Beschichtung**
- kompatibel zu **Shimano / Sram / Campagnolo**
- silber

›Ninespeed AR‹

- with **anti rust coating**
- compatible with **Shimano / Sram / Campagnolo**
- silver



301902
U
19,90 €

›Ninespeed‹

- kompatibel zu **Shimano / Sram / Campagnolo**
- dunkelgrau

›Ninespeed‹

- compatible with **Shimano / Sram / Campagnolo**
- dark grey



›EIGHTSPEED‹

- für **8, 7, 6-fach** Schaltungssysteme
- auch für **Nabenschaltungen** geeignet
- 1/2" x 3/32"
- 116 Glieder
- mit Verschlussglied
- im M-Wave Einzelkarton

›EIGHTSPEED‹

- for **8, 7, 6 speed**
- also suitable for **internal gear hubs**
- 1/2" x 3/32"
- 116 links
- with connecting link
- in M-Wave box



301908
U
19,90 €

›Eightspeed AR‹

- mit **Antirost-Beschichtung**
- silber

›Eightspeed AR‹

- with **anti rust coating**
- silver



301907
U
11,90 €

›Eightspeed‹

- silber / grau

›Eightspeed‹

- silver / grey



301904
U
7,90 €





›SEVENSPEED‹

- für **7, 6, 5, 1-fach** Schaltungssysteme
- 1/2" x 3/32"
- 116 Glieder
- 7,3 mm
- grau / braun
- mit Verschlussglied
- im M-Wave Einzelkarton

›SEVENSPEED‹









- for **7, 6, 5, 1 speed**
- 1/2" x 3/32"
- 116 links
- 7.3 mm
- grey / brown
- with connecting link
- in M-Wave box



ART.-NR. UVP	BESCHREIBUNG	DESCRIPTION	
	 <p>›SINGLESPEED‹</p> <ul style="list-style-type: none"> • für 1-fach • auch für Nabenschaltungen geeignet • 112 Glieder • mit Verschlussglied • im M-Wave Einzelkarton 	<p>›SINGLESPEED‹</p> <ul style="list-style-type: none"> • for 1 speed • also suitable for internal gear hubs • 112 links • with connecting link • in M-Wave single box 	
301945 U 17,90 € 	<p>›Singlespeed E‹</p> <ul style="list-style-type: none"> • besonders geeignet für E-Bikes • längere Haltbarkeit durch Verstärkungen • für Brose, Bosch, Shimano, Bafang, ... Antriebe • 1/2" x 3/32" • silber 	<p>›Singlespeed E‹</p> <ul style="list-style-type: none"> • particularly suitable for e-bikes • longer durability due to reinforcements • for Brose, Bosch, Shimano, Bafang, ... drives • 1/2" x 3/32" • silver 	
301915 U 9,90 €	<p>›Singlespeed AR‹</p> <ul style="list-style-type: none"> • mit Antirost-Beschichtung • 1/2" x 1/8" • silber 	<p>›Singlespeed AR‹</p> <ul style="list-style-type: none"> • with anti rust coating • 1/2" x 1/8" • silver 	
301905 U 4,90 €	<p>›Singlespeed‹</p> <ul style="list-style-type: none"> • 1/2" x 1/8" • grau / braun 	<p>›Singlespeed‹</p> <ul style="list-style-type: none"> • 1/2" x 1/8" • grey / brown 	

FÜR WERKSTÄTTEN UND MONTAGEN

FOR WORKSHOPS AND FACTORIES

	KETTEN AUF ROLLE	CHAINS ON REEL	
	<p>• 15 m Rolle</p> <p>• inkl. 10 Verschlussgliedern</p> <p>• im praktischen braunen Karton zum Abrollen</p>	<p>• 15 m reel</p> <p>• incl. 10 chain connecting links</p> <p>• in practical brown box to roll off</p>	
301970 17,90 €	<p>• für 11-fach Schaltungssysteme</p> <p>• 1/2" x 11/128"</p> <p>• kompatibel zu Shimano / Sram / Campagnolo</p> <p>• grau</p>	<p>• for 11 speed</p> <p>• 1/2" x 11/128"</p> <p>• compatible with Shimano / Sram / Campagnolo</p> <p>• grey</p>	
301971 16,90 €	<p>• für 10-fach Schaltungssysteme</p> <p>• 1/2" x 11/128"</p> <p>• kompatibel zu Shimano / Sram / Campagnolo</p> <p>• grau</p>	<p>• for 10 speed</p> <p>• 1/2" x 11/128"</p> <p>• compatible with Shimano / Sram / Campagnolo</p> <p>• grey</p>	
301972 11,90 €	<p>• für 9-fach Schaltungssysteme</p> <p>• 1/2" x 11/128"</p> <p>• kompatibel zu Shimano / Sram / Campagnolo</p> <p>• grau</p>	<p>• for 9 speed</p> <p>• 1/2" x 11/128"</p> <p>• compatible with Shimano / Sram / Campagnolo</p> <p>• grey</p>	
301973 9,90 €	<p>• für 8, 7, 6, 1-fach Schaltungssysteme</p> <p>• auch für Nabenschaltungen geeignet</p> <p>• 1/2" x 3/32"</p> <p>• silber/grau</p>	<p>• for 8, 7, 6, 1 speed</p> <p>• also suitable for internal gear hubs</p> <p>• 1/2" x 3/32"</p> <p>• silver/grey</p>	
301974 6,90 €	<p>• für 7, 6, 5, 1-fach Schaltungssysteme</p> <p>• auch für Nabenschaltungen geeignet</p> <p>• 1/2" x 3/32"</p> <p>• 7,3 mm</p> <p>• grau / braun</p>	<p>• for 7, 6, 5, 1 speed</p> <p>• also suitable for internal gear hubs</p> <p>• 1/2" x 3/32"</p> <p>• 7.3 mm</p> <p>• grey / brown</p>	
301975 4,90 €	<p>• für 1-fach Schaltungssysteme</p> <p>• auch für Nabenschaltungen geeignet</p> <p>• 1/2" x 1/8"</p> <p>• braun</p>	<p>• for 1 speed</p> <p>• also suitable for internal gear hubs</p> <p>• 1/2" x 1/8"</p> <p>• brown</p>	

Chains

ART.-NR. UVP **BESCHREIBUNG**

DESCRIPTION



M-WAVE VERSCHLUSSGLIED

- wiederverwendbar
- 1 Set auf Eurolochkarte

M-WAVE CHAIN CONNECTING LINK

- reusable
- 1 set on eurohole card

301926

›Fusion 11‹

- für 11-fach Kette 1/2" x 11/128"
- passend für M-Wave, **Sram, Shimano, KMC, ...**

›Fusion 11‹

- for 11 speed chain 1/2" x 11/128"
- suitable for M-Wave, **Sram, Shimano, KMC, ...**



9,90 €

301920

›Fusion 10‹

- für 10-fach Ketten
- 5,88 mm
- passend für M-Wave, **Sram, Shimano, KMC, ...**

›Fusion 10‹

- for 10 speed chains
- 5.88 mm
- suitable for M-Wave, **Sram, Shimano, KMC, ...**



5,90 €

301921

›Fusion 9‹

- für 9-fach Ketten
- 6,6 mm
- passend für M-Wave, **Sram, Shimano, KMC, ...**

›Fusion 9‹

- für 9 speed chains
- 6.6 mm
- suitable for M-Wave, **Sram, Shimano, KMC, ...**



4,90 €

301925

›Fusion 5-8‹

- für (5/6/7) 8-fach Ketten
- 7,3 mm

›Fusion 5-8‹

- for (5/6/7) 8 speed chains
- 7.3 mm



3,90 €

301924

SNAP ON VERSCHLUSSGLIED

›FUSION 1‹

- für 1-fach 1/2" x 1/8"
- grau
- 8 mm
- 1 Set auf Eurolochkarte

SNAP ON CONNECTOR

›FUSION 1‹

- for single speed 1/2" x 1/8"
- grey
- 8 mm
- 1 set on eurohole card



2,49 €

303311

KETTENFÜHRUNG

›STEWARD UP‹

- geeignet für **1-fach** Kettenrad-garnituren
- Montage am **Sattelrohr** Ø 34,9 mm (inkl. Adapter für 31,8 mm)
- aus hochwertigen **Nylon-** und **Glasfasern**
- **Aluminium**-Klemme
- Höhenverstellung: 15 mm
- nur 77 g (ohne Adapter)
- auf M-Wave Eurolochkarte

CHAIN GUIDE

›STEWARD UP‹

- suitable for **1 speed** chainwheel sets
- mounting at the **seat tube** Ø 34.9 mm (incl. adapter for 31.8 mm)
- made of high quality **nylon** and **glass fibre**
- **aluminium** clamp
- height adjustment: 15 mm
- only 77 g (without adapter)
- on M-Wave eurohole card



U
29,90 €

300183

KETTENABWEISER

›CHAIN CATCHER‹

- **verhindert** das **Herabfallen** und **Verkleben der Kette**
- aus **Aluminium**
- Länge 100 mm
- mit **verlängertem Schraubloch** zur genauen Justierung
- inkl. 2 CrMo Schrauben (M5 x 20/25 mm) passend für **Shimano, Campagnolo** und **Sram**
- auf M-Wave Eurolochkarte



CHAIN DEFLECTOR



›CHAIN CATCHER‹



- **prevents chain** from **falling down** and **jamming**
- made of **aluminium**
- length 100 mm
- with **slotted hole** for exact adjustment
- incl. 2 CrMo screws (M5 x 20/25 mm) suitable for **Shimano, Campagnolo** and **Sram**
- on M-Wave eurohole card



12,90 €

ART.-NR. UVP	BESCHREIBUNG	DESCRIPTION	
	<p>KETTENABWEISER</p> <ul style="list-style-type: none"> • verhindert das Herabfallen und Verklemmen der Kette • aus Kunststoff • auf M-Wave Eurolochkarte 	<p>CHAIN DEFLECTOR</p> <ul style="list-style-type: none"> • prevents chain from falling down and jamming • made of plastic • on M-Wave eurohole card 	 
300180 U	für 31,8 mm Sitzrohre	for 31.8 mm seat tubes	
300181 U 4,90 €	für 34,9 mm Sitzrohre	for 34.9 mm seat tubes	

303312 10,90 €	<p>UNIVERSAL-SCHUTZFOLIE ›PROTECTO CUT-TO-FIT‹</p> <ul style="list-style-type: none"> • individuell zuschneidbar • selbstklebend • geräuschkämmend • leicht formbar • Größe: ca. 400 x 90 mm • für Unterrohr, Motorengehäuse, Kettenstrebe, ... • Material: PU • schwarz • im Polybeutel mit M-Wave Eurolochheader 	<p>UNIVERSAL PROTECTION ›PROTECTO CUT-TO-FIT‹</p> <ul style="list-style-type: none"> • individually cut to size • self-adhesive • noise absorbing • easy to shape • size: approx. 400 x 90 mm • for down tube, motor cover, chain stay, ... • material: PU • black • in PE bag with M-Wave eurohole header 	 
--------------------------	---	---	---

303351 6,90 €	<p>SCHUTZFOLIEN-SET XL</p> <ul style="list-style-type: none"> • passend für die meisten Rahmen • universell zuschneidbarer Schutz • selbstklebend, transparent • bestehend aus: 1 Stk. 500 x 55 mm 1 Stk. 260 x 35 mm 6 Stk. 35 x 35 mm • im Polybeutel mit M-Wave Eurolochheader 	<p>PROTECTION FOIL SET XL</p> <ul style="list-style-type: none"> • suitable for the most frames • universally cuttable protection • selfadhesive, transparent • consisting of: 1 pc 500 x 55 mm 1 pc 260 x 35 mm 6 pcs 35 x 35 mm • in PE bag with M-Wave eurohole header 	 
-------------------------	---	---	---

303333 3,60 €	<p>KETTENSTREBENSCHUTZ ›PROTECTO XL‹</p> <ul style="list-style-type: none"> • schwarzes Neopren • Größe: 260 x (100 - 130) mm • im Polybeutel mit M-Wave Eurolochheader 	<p>CHAIN STAY PROTECTOR ›PROTECTO XL‹</p> <ul style="list-style-type: none"> • black neoprene • size: 260 x (100 - 130) mm • in PE bag with M-Wave eurohole header 	
-------------------------	---	--	---

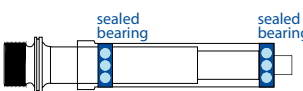
313451 U 34,90 €	<p>KLICKPEDAL ›DRAG-R1‹</p> <ul style="list-style-type: none"> • Aluminiumkörper • CrMo-Achse • mit gedichteten Kugellagern • große Auflagefläche für hohen Komfort und optimale Kraftübertragung • kompatibel zum Look Keo System (kein original Look Ersatzteil) • mit Schuhplattenset, 9° drehbar • nur 327 g/Pair • auf M-Wave Eurolochkarte 	<p>CLIPLESS PEDAL ›DRAG-R1‹</p> <ul style="list-style-type: none"> • aluminium body • CrMo axle • with sealed bearings • large pedalling area for high comfort and great pedalling efficiency • compatible with Look Keo system (no original Look spare part) • with cleat set, 9° turnable • only 327 g/pair • on M-Wave eurohole card 	 
-------------------------------	--	---	---

ART.-NR. UVP **BESCHREIBUNG**

DESCRIPTION

312062 U **KLICKPEDAL ›DRAG-R2‹**

44,90 €



 **284 g**

- **Aluminiumkörper**
- **CrMo-Achse**
- mit **gedichtetem Industriekugellager** und **hochwertigem Gleitlager**
- Montage auch mit Innensechskantschlüssel möglich
- Käfig schützt Klickmechanismus
- nur **284 g/Pair**
- mit Schuhplattenset
- kompatibel zum **Shimano** System (kein original Shimano Ersatzteil)
- auf M-Wave Eurolochkarte

CLIPLESS PEDAL ›DRAG-R2‹

- **aluminium body**
- **CrMo axle**
- with **sealed bearing** and **high quality bush bearing**
- mounting also possible with allen key
- cage protects click mechanism
- only **284 g/pair**
- with cleat set
- compatible with **Shimano** system (no original Shimano spare part)
- on M-Wave eurohole card

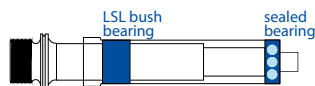

Tested by the manufacturer based on ISO 4210

310051 **PLATTFORM FÜR SYSTEMPEDALE ›TRANSFORMER A‹**

21,90 €

 **38 g**

- **verwandelt Klickpedale in Plattformpedale**
- passend für **SPD, Look Keo, ...** Schuhplatten (kein original Shimano, Look Ersatzteil)
- mit je 12 **austauschbaren Aluminium-Pins**
- 85 x 90 mm
- Aluminium
- nur **38 g/Stk.**
- auf M-Wave Eurolochkarte

PLATFORM FOR SYSTEM PEDALS ›TRANSFORMER A‹

- **changes clipless pedals to platform pedals**
- suitable for **SPD, Look Keo, ...** cleats (no original Shimano, Look spare part)
- with 12 **exchangeable aluminium pins** each
- 85 x 90 mm
- aluminium
- only **38 g/pcs.**
- on M-Wave eurohole card

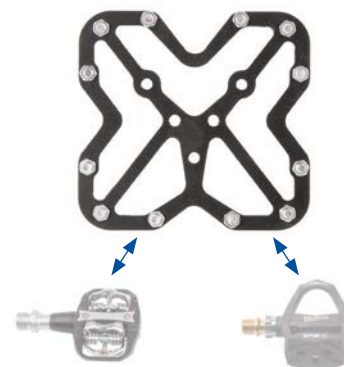

310050 U **PLATTFORM FÜR KLICKPEDALE ›TRANSFORMER‹**

12,90 €

- verwandelt **Klickpedale in Plattformpedale**
- **SPD-kompatibel**
- mit Reflektoren
- inkl. **Schuhplatten-Set aus Metall**
- 73 x 77 mm (L x B)
- auf M-Wave Eurolochkarte

PLATFORM FOR CLIPLESS PEDALS ›TRANSFORMER‹

- changes **click pedals to platform pedals**
- **SPD compatible**
- with reflectors
- incl. **metal cleat set**
- 73 x 77 mm (L x W)
- on M-Wave eurohole card



312150 **PLATTFORM-KOMBIPEDAL ›FREEDOM CLIPLESS‹**

64,90 €



 **CLIP & PINS**

- **CNC-gefräster Aluminiumkörper**
- **CrMo-Achse**
- mit **gedichtetem Industriekugellager** und **hochwertigem Gleitlager**
- Montage auch mit Innensechskant möglich
- mit Schuhplattenset
- kompatibel zum **Shimano** System (kein original Shimano Ersatzteil)
- mit **austauschbaren** Pins auf einer Seite
- Trittfläche: ca. 92 x 102 mm (L x B)
- nur 437 g
- auf M-Wave Eurolochkarte

PLATFORM COMBINATION PEDAL ›FREEDOM CLIPLESS‹

- **CNC machined aluminium body**
- **CrMo axle**
- with **sealed bearing** and **high quality bush bearing**
- mounting also possible with allen key
- with cleat set
- compatible with **Shimano** system (no original Shimano spare part)
- with **exchangeable** pins at one side
- tread surface: approx. 92 x 102 mm (L x W)
- only 437 g
- on M-Wave eurohole card

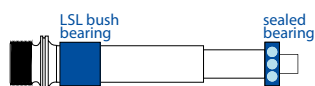

Tested by the manufacturer based on ISO 4210

ART.-NR. BESCHREIBUNG
UVP

DESCRIPTION

311099 KOMBIPEDAL ›PEASY‹

U
44,90 €



- **Doppelfunktionspedale:** beidseitig verwendbar für normale (Sport-)Schuhe und für Klick-Schuhe
- **Aluminiumkörper** und -käfig
- silberne, **CNC-gefräste CrMo-Achse**
- mit **Industriekugellagern**
- nur **319 g/**Paar (ohne Reflektoren)
- mit abnehmbaren **Reflektoren**
- mit **deutschem Prüfzeichen**
- mit Schuhplattenset (auch passend für Shimano Pedale)
- Pedal passt auch für Shimano Schuhplatten (kein original Shimano Ersatzteil)
- Trittfläche: 63 x 80 mm (L x B)
- auf M-Wave Eurolochkarte

COMBINATION PEDAL ›PEASY‹

- **double function pedals:** useable on both sides for normal (sport-)shoes and for clipless shoes
- **aluminium** body and cage
- silver **CNC machined CrMo axle**
- with **sealed bearings**
- only **319 g/**pair (without reflectors)
- with detachable **reflectors**
- with **German approval number**
- with cleat set (also suitable for Shimano pedals)
- pedal also suitable for Shimano cleats (no original Shimano spare part)
- tread surface: 63 x 80 mm (L x W)
- on M-Wave eurohole card



Tested by the manufacturer based on ISO 4210

312060 KOMBIPEDAL ›DRAG-T1‹

U
46,90 €



- **Aluminiumkörper**
- mit **Antirutschauflage**
- CrMo-Achse mit Innensechskantschlüssel-Kopf
- mit Industriekugellager
- nur 349 g/
- Pedal passt auch für **Shimano Schuhplatten** (kein original Shimano Ersatzteil)
- Trittfläche: 95 x 73 mm (L x B)
- auf M-Wave Eurolochkarte

COMBINATION PEDAL ›DRAG-T1‹

- **aluminium** body
- with **non-slip rubber layer**
- CrMo-Achse axle with allen key head
- with sealed bearing
- only 349 g/
- pedal also suitable for **Shimano cleats** (no original Shimano spare part)
- tread surface: 95 x 73 mm (L x W)
- on M-Wave eurohole card

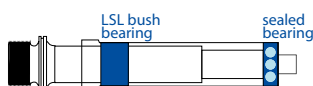

Tested by the manufacturer based on ISO 4210

312061 KOMBIPEDAL ›DRAG-T2‹

U
38,90 €



- **Doppelfunktionspedale:** beidseitig verwendbar für normale (Sport-)Schuhe und für Klick-Schuhe
- **Aluminiumkörper**
- **einfacher Einstieg**
- **verchromte CrMo-Achse**
- Montage auch mit **Innensechskantschlüssel** möglich
- mit **Non-Slip** Gummiauflage
- mit Schuhplattenset (auch **passend für Shimano** Pedale)
- Pedal passt auch für **Shimano Schuhplatten** (kein original Shimano Ersatzteil)
- Trittfläche: 72 x 99 mm (L x B)
- auf M-Wave Eurolochkarte

COMBINATION PEDAL ›DRAG-T2‹

- **double function pedals:** useable on both sides for normal (sport-)shoes and for clipless shoes
- **aluminium** body
- **easy step-in system**
- **chromed CrMo** axle
- mounting also possible with **allen key**
- with **non-slip** rubber layer
- with cleat set (also **suitable for Shimano** pedals)
- pedal also suitable for **Shimano cleats** (no original Shimano spare part)
- tread surface: 72 x 99 mm (L x W)
- on M-Wave eurohole card



Tested by the manufacturer based on ISO 4210

ART.-NR. UVP **BESCHREIBUNG**

DESCRIPTION



PEDAL ›STEADY A3‹

- Aluminiumkörper und -käfig
- silberne CrMo-Achse
- mit deutschem Prüfzeichen
- mit Reflektoren
- Montage auch mit Innensechskant möglich
- extra breite Trittfläche: 82 x 103 mm (L x B)

PEDAL ›STEADY A3‹

- aluminium body and cage
- silver CrMo axle
- with German approval number
- with reflectors
- mounting also possible with allen key
- extra wide tread surface: 82 x 103 mm (L x W)



311710 Montageverpackung

OEM

311109 auf M-Wave Eurolochkarte
17,90 €

on M-Wave eurohole card

Tested by the manufacturer based on ISO 4210

PEDAL ›STEADY A4‹

- Aluminiumkörper und -käfig
- gedichtete, verchromte CrMo-Achse
- Montage mit Innen- und Außen-sechskantschlüssel möglich
- Trittfläche: 64 x 94 mm (L x B)

PEDAL ›STEADY A4‹

- aluminium body and cage
- sealed, c. p. CrMo axle
- mounting possible with allen key and open hex wrench
- tread surface: 64 x 94 mm (L x W)

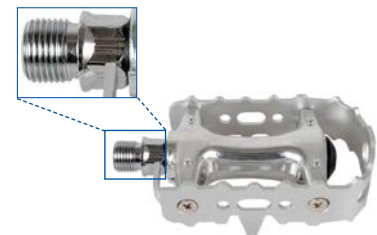

silberner Käfig

silver cage

311024 Montageverpackung

OEM

311112 auf M-Wave Eurolochkarte

on M-Wave eurohole card

schwarzer Käfig

black cage

311063 Montageverpackung

OEM

311113 auf M-Wave Eurolochkarte

on M-Wave eurohole card

14,90 €

Tested by the manufacturer based on ISO 4210



PEDAL ›STEADY-A 2‹

- Aluminiumkörper und -käfig
- 9/16"-Boron-Achse mit hochwertigem Polymer-Gleitlager
- mit Reflektoren
- mit deutschem Prüfzeichen
- Montage auch mit Innensechskantschlüssel möglich
- Trittfläche: 62 x 90 mm (L x B)

PEDAL ›STEADY-A 2‹

- aluminium body and cage
- 9/16" boron axle with high-quality polymer plain bearing
- with reflectors
- with German approval number
- mounting also possible with allen key
- tread surface: 62 x 90 mm (L x W)



311107 Montageverpackung

OEM

311108 auf M-Wave Eurolochkarte

on M-Wave eurohole card

14,90 €

Tested by the manufacturer based on ISO 4210



PEDAL ›STEADY-A‹

- Aluminiumkörper
- Stahlkäfig
- mit Reflektoren
- mit deutschem Prüfzeichen
- Trittfläche: 60 x 92 mm (L x B)

PEDAL ›STEADY-A‹

- aluminium body
- steel cage
- with reflectors
- with German approval number
- tread surface: 60 x 92 mm (L x W)



311317 Montageverpackung



OEM



311320 auf M-Wave Eurolochkarte

on M-Wave eurohole card



9,90 €

ART.-NR. UVP	BESCHREIBUNG	DESCRIPTION	
	PEDAL ›STEADY A5‹ <ul style="list-style-type: none"> • Aluminiumkörper und -käfig • Trittfläche: 70 x 94 mm (L x B) 	PEDAL ›STEADY A5‹ <ul style="list-style-type: none"> • aluminium body and cage • tread surface: 70 x 94 mm (L x W) 	
• 311049 U	Montageverpackung	OEM	
311114 8,90 €	auf M-Wave Eurolochkarte	on M-Wave eurohole card	

	PEDAL ›STEADY K1‹ <ul style="list-style-type: none"> • Kunststoffkörper • Stahlkäfig • mit Reflektoren • mit deutschem Prüfzeichen • Trittfläche: 61 x 95 mm (L x B) 	PEDAL ›STEADY K1‹ <ul style="list-style-type: none"> • PP body • steel cage • with reflectors • with German approval number • tread surface: 61 x 95 mm (L x W) 		
	311319	Montageverpackung		OEM
	311115 7,90 €	auf M-Wave Eurolochkarte		on M-Wave eurohole card

	ANTI-RUTSCHPEDAL ›STEADY FLAT 2 AL‹ <ul style="list-style-type: none"> • Aluminiumkörper • Boron-Achse • mit hochwertigem Polymer-Gleitlager • mit deutschem Prüfzeichen • mit Non-Slip Gummiauflage • mit Reflektoren • Trittfläche: 82 x 96 mm (L x B) • Montage auch mit Innensechskant möglich 	NON-SLIP PEDAL ›STEADY FLAT 2 AL‹ <ul style="list-style-type: none"> • aluminium body • Boron axle • with high-quality polymer plain bearing • with german approval number • with non-slip rubber layer • with reflector • tread surface: 82 x 96 mm (L x W) • mounting also possible with allen key 		
	312012	Montageverpackung		OEM
	312013 19,90 €	auf M-Wave Eurolochkarte		on M-Wave eurohole card

Tested by the manufacturer based on ISO 4210

	ANTI-RUTSCHPEDAL ›STEADY A6‹ <ul style="list-style-type: none"> • Aluminiumkörper und -käfig • mit großer schwarzer Gummiauflagefläche • Boron-Achse • mit deutschem Prüfzeichen • mit Reflektoren • Trittfläche: 73 x 97 mm (L x B) 	NON-SLIP PEDAL ›STEADY A6‹ <ul style="list-style-type: none"> • aluminium body and cage • with big black rubber surface • boron axle • with German approval number • with reflectors • tread surface: 73 x 97 mm (L x W) 		
	311830	Montageverpackung		OEM
	311116 17,90 €	auf M-Wave Eurolochkarte		on M-Wave eurohole card

Tested by the manufacturer based on ISO 4210

ART.-NR. BESCHREIBUNG
UVP

DESCRIPTION



**ANTI-RUTSCHPEDAL
›STEADY A7‹**

- Aluminiumkörper und -käfig
- anatomisch geformte, **konkave Trittfläche** mit **Aluminium-Non-Slip-Profil**
- schwarze, **gedichtete** Boron-Achse
- mit **Reflektoren**
- mit **deutschem Prüfzeichen**
- nur 379 g/Pair
- Trittfläche: 81 x 97 mm (L x B)

**NON-SLIP PEDAL
›STEADY A7‹**

- **aluminium body** and **cage**
- anatomic shaped, **concave platform** with **aluminium non-slip profile**
- black, **sealed** boron axle
- with **reflectors**
- with **German approval number**
- only 379 g/pair
- tread surface: 81 x 97 mm (L x W)



ANATOMIC

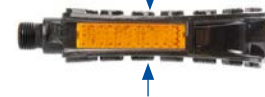

• **311106** Montageverpackung

OEM

311117 auf M-Wave Eurolochkarte
13,90 €

on M-Wave eurohole card



**ANTI-RUTSCHPEDAL
›STEADY C‹**

- Aluminiumkörper
- **CrMo**-Achse
- mit **Non-Slip Gummiauflage**
- mit **Reflektoren**
- mit **deutschem Prüfzeichen**
- Montage auch mit **Innensechskant** möglich
- Trittfläche: 80 x 95 mm (L x B)

**NON-SLIP PEDAL
›STEADY C‹**

- **aluminium body**
- **CrMo** axle
- with **non-slip rubber layer**
- with **reflectors**
- with **German approval number**
- mounting also possible with **allen key**
- tread surface: 80 x 95 mm (L x W)



311121 Montageverpackung

OEM

311040 auf M-Wave Eurolochkarte
11,90 €

on M-Wave eurohole card



**ANTI-RUTSCHPEDAL
›STEADY A8‹**

- Aluminiumkörper und -käfig
- **CNC-gefräste CrMo**-Achse
- mit **Non-Slip Gummiauflage**
- mit **Kugellager**
- mit **Reflektoren**
- mit **deutschem Prüfzeichen**
- Trittfläche: 70 x 95 mm (L x B)

**NON-SLIP PEDAL
›STEADY A8‹**

- **aluminium body** and **cage**
- **CNC machined CrMo** axle
- with **non-slip rubber layer**
- with **ball bearing**
- with **reflectors**
- with **German approval number**
- tread surface: 70 x 95 mm (L x W)



311000 Montageverpackung
U

OEM

311122 auf M-Wave Eurolochkarte
12,90 €

on M-Wave eurohole card

Tested by the manufacturer based on ISO 4210



**ANTI-RUTSCHPEDAL
›STEADY A9‹**

- Aluminiumkörper und -käfig
- mit **Non-Slip Gummiauflage**
- mit **Reflektoren**
- mit **deutschem Prüfzeichen**
- Trifffläche: 70 x 96 mm (L x B)

**NON-SLIP PEDAL
›STEADY A9‹**

- **aluminium body** and **cage**
- with **non-slip rubber layer**
- with **reflectors**
- with **German approval number**
- tread surface: 70 x 96 mm (L x W)



• **311002** Montageverpackung
U

OEM

311123 auf M-Wave Eurolochkarte
9,90 €

on M-Wave eurohole card

ART.-NR. UVP	BESCHREIBUNG	DESCRIPTION
-----------------	--------------	-------------



**ANTI-RUTSCHPEDAL
'STEADY FLAT'**

- Kunststoffkörper mit sandartiger Anti-Rutschauflage
- Boron-Achse
- mit hochwertigem Polymer-Gleitlager
- mit deutschem Prüfzeichen
- mit Reflektoren
- Montage auch mit Innensechskant möglich
- Trittfläche: 86 x 96 mm (L x B)



**NON-SLIP PEDAL
'STEADY FLAT'**

- plastic body with sandlike non-slip layer
- boron axle
- with high-quality polymer plain bearing
- with german approval number
- with reflectors
- mounting also possible with allen key
- tread surface: 86 x 96 mm (L x W)



311523 auf M-Wave Eurolochkarte

on M-Wave eurohole card

- **311503** Montageverpackung
12,90 €

OEM



**ANTI-RUTSCHPEDAL
'STEADY BEACH'**

- schwarzer Kunststoffkörper mit doppelter Anti-Rutschauflage:
 - sandartige Oberfläche
 - high-low Noppen
- Boron-Achse
- anatomisch geformte, konkave Auflagefläche
- mit Reflektoren
- mit deutschem Prüfzeichen
- Montage auch mit Innensechskant möglich
- Trittfläche: 89 x 97 mm (L x B)



**NON-SLIP PEDAL
'STEADY BEACH'**

- black plastic body with double non-slip layer
 - sandlike surface
 - high-low knobs
- boron axle
- anatomically shaped concave supporting surface
- with reflectors
- with German approval number
- mounting also possible with allen key
- tread surface: 89 x 97 mm (L x W)



ANATOMIC

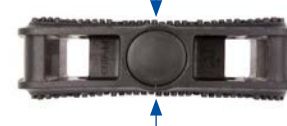

311502 auf M-Wave Eurolochkarte

on M-Wave eurohole card

- **311500** Montageverpackung
9,90 €

OEM



**ANTI-RUTSCHPEDAL
'STEADY C ECO'**

- Kunststoffkörper
- CrMo-Achse
- mit Kugellager
- mit Non-Slip Gummiauflage
- mit Reflektoren
- mit deutschem Prüfzeichen
- Montage auch mit Innensechskant möglich
- Trittfläche: 80 x 95 mm (L x B)

**NON-SLIP PEDAL
'STEADY C ECO'**

- plastic body
- CrMo axle
- with ball bearing
- with non-slip rubber layer
- with reflectors
- with German approval number
- mounting also possible with allen key
- tread surface: 80 x 95 mm (L x W)



311124 Montageverpackung

OEM

311041 auf M-Wave Eurolochkarte
7,90 €

on M-Wave eurohole card

ART.-NR. UVP **BESCHREIBUNG** **DESCRIPTION**



ANTI-RUTSCHPEDAL ›STEADY K2‹

- mit **Non-Slip TPR-Auflage**
- mit **Kugellager**
- mit **Reflektoren**
- mit **extra großer Trittfläche:**
75 x 96 mm (L x B)

NON-SLIP PEDAL ›STEADY K2‹

- with **non-slip TPR-layer**
- with **ball bearing**
- with **reflectors**
- with **extra wide tread surface:**
75 x 96 mm (L x W)



311011 mit **deutschem Prüfzeichen**

with **German approval number**



ohne deutsches Prüfzeichen

without German approval number

311508 U Montageverpackung

OEM

311125 auf M-Wave Eurolochkarte
5,90 €

on M-Wave eurohole card



ANTI-RUTSCHPEDAL ›STEADY FLAT 2‹

- **Non-Slip Profil**
- Kunststoffkörper
- **Boron-Achse**
- mit hochwertigem **Polymer-Gleitlager**
- Montage auch mit **Innensechskant** möglich
- mit **Reflektoren**
- mit **deutschem Prüfzeichen**
- Trittfläche: 84 x 93 mm (L x B)

NON-SLIP PEDAL ›STEADY FLAT 2‹

- **non-slip profile**
- plastic body
- **boron axle**
- with high-quality **polymer plain bearing**
- mounting also possible with **allen key**
- with **reflectors**
- with **german approval number**
- tread surface: 84 x 93 mm (L x W)



312011 auf M-Wave Eurolochkarte

on M-Wave eurohole card

312010 Montageverpackung
6,90 €

OEM



PEDAL ›STEADY K3‹

- schwarzer Kunststoffkörper
- mit **Kugellager**
- **Trittfläche: 72 x 95 mm (L x B)**
- mit **Reflektoren**

PEDAL ›STEADY K3‹

- black plastic body
- with **ball bearing**
- **tread surface: 72 x 95 mm (L x W)**
- with **reflectors**

mit **deutschem Prüfzeichen**

with **German approval number**

313306 Montageverpackung

OEM

311126 auf M-Wave Eurolochkarte

on M-Wave eurohole card

ohne deutsches Prüfzeichen

without German approval number

313301 U Montageverpackung

OEM

311127 auf M-Wave Eurolochkarte
4,90 €

on M-Wave eurohole card



ART.-NR. BESCHREIBUNG
UVP

DESCRIPTION



**KINDER- UND JUGEND-
ANTI-RUTSCHPEDAL
›STEADY K4‹**

- schwarzer Kunststoffkörper
- mit grauer **Non-Slip Gummiauflage**
- mit **Reflektoren**
- mit **deutschem Prüfzeichen**
- Trittfläche: 60 x 82 mm (L x B)

**KIDS AND JUVENILE
NON-SLIP PEDAL
›STEADY K4‹**

- black PP body
- with grey **non-slip rubber layer**
- with **reflectors**
- with **German approval number**
- tread surface: 60 x 82 mm (L x W)



311046 Montageverpackung

OEM

311128 auf M-Wave Eurolochkarte
4,90 €

on M-Wave eurohole card



FALTPEDAL ›STEADY F1‹

- **Aluminium/Kunststoffkörper**
- **CrMo-Achse**
- **leicht und sicher faltbar**
- **beidseitig** verwendbar
- mit **Non-Slip Gummiauflage**
- mit **Reflektoren**
- mit **deutschem Prüfzeichen**
- Trittfläche: 69 x 98 mm (L x B)

FOLDING PEDAL ›STEADY F1‹

- **aluminium/PP body**
- **CrMo axle**
- **simply and safely foldable**
- usable on **both sides**
- with **non-slip rubber layer**
- with **reflectors**
- with **German approval number**
- tread surface: 69 x 98 mm (L x W)



• **311765** _U Montageverpackung

OEM

311129 auf M-Wave Eurolochkarte
13,90 €

on M-Wave eurohole card



**PLATTFORM-PEDAL
›FREEDOM SL‹**

- **CNC gefräster Aluminiumkörper**
- **CNC gefräste CrMo-Achse**
- mit **Industriekugellager**
- Montage auch mit Innensechskant möglich
- mit austauschbaren Pins
- gemäß **ISO 4210**: erhöhte Anforderungen bis **140 kg**
- nur **297 g/**Paar
- Trittfläche: 96 x 91 mm (L x B)

**FLAT PEDAL
›FREEDOM SL‹**

- **CNC machined aluminium body**
- **CNC machined CrMo axle**
- with **sealed bearing**
- mounting also possible with allen key
- with interchangeable pins
- based on **ISO 4210**: increased requirements up to **140 kg**
- only **297 g/**pair
- tread surface: 96 x 91 mm (L x W)



schwarz
• **311130** Montageverpackung

black
OEM

313340 _U auf M-Wave Eurolochkarte

on M-Wave eurohole card

titangrau
• **311131** Montageverpackung

titan grey
OEM

313341 _U auf M-Wave Eurolochkarte
41,90 €

on M-Wave eurohole card

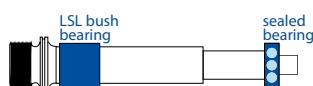

Tested by the manufacturer based on ISO 4210

ART.-NR. BESCHREIBUNG
UVP

DESCRIPTION

XXL

**PLATTFORM-PEDAL
›FREEDOM CS‹**

**FLAT PEDAL
›FREEDOM CS‹**

328 g

- **sehr großer und stabiler Nylonkörper**
- besonders **große XXL-Trittläche:**
120 x 110 mm (L x B)
- **CrMo-Achse**
- mit **2 gedichteten Industriekugellagern**
- mit **austauschbaren Pins**
- nur **328 g/Pair**

- **very large and stable nylon body**
- **extra wide XXL tread surface:**
120 x 110 mm (L x W)
- **CrMo axle**
- with **2 sealed bearings**
- with **exchangeable pins**
- only **328 g/pair**

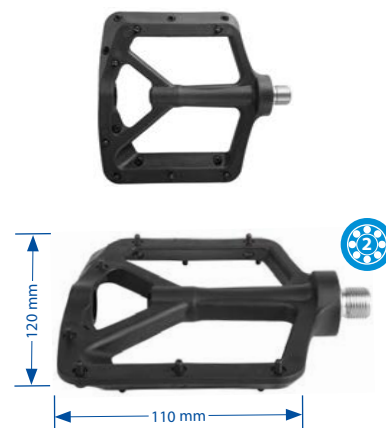

311132 Montageverpackung

OEM

313350 auf M-Wave Eurolochkarte
U
24,90 €

on M-Wave eurohole card

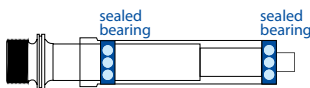

**PLATTFORM-PEDAL
›STEADY FLAT 3‹**

**FLAT PEDAL
›STEADY FLAT 3‹**



397 g

- **Aluminiumkörper**
- Montage auch mit Innensechskant möglich
- mit **hochwertigem Polymer-Gleitlager**
- mit austauschbaren Pins
- mit **Reflektoren**
- mit **deutschem Prüfzeichen**
- nur **397 g/Pair**
- Trittläche: **93 x 97 mm** (L x B)

- **aluminium body**
- mounting also possible with allen key
- with **high quality polymer** plain bearing
- with interchangeable pins
- with **reflectors**
- with **German approval number**
- only **397 g/pair**
- tread surface: **93 x 97 mm** (L x W)



311532 auf M-Wave Eurolochkarte

on M-Wave eurohole card

311531 Montageverpackung
24,90 €

OEM



398 g

PLATTFORM-PEDAL ›FLAT‹

FLAT PEDAL ›FLAT‹

- **Aluminiumkörper**
- **gedichtete Achse**
- mit **hochwertigem Polymer-Gleitlager**
- mit austauschbaren Pins
- nur **398 g/Pair**
- Trittläche: **105 x 94 mm** (L x B)

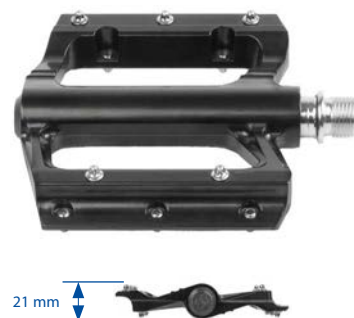
- **aluminium body**
- **sealed axle**
- with **high quality polymer** plain bearing
- with exchangeable pins
- only **398 g/pair**
- tread surface: **105 x 94 mm** (L x W)



311133 Montageverpackung

OEM

313315 auf M-Wave Eurolochkarte
19,90 €

on M-Wave eurohole card



**PLATTFORM-PEDAL
›STEADY A10‹**

**FLAT PEDAL
›STEADY A10‹**



- **Aluminiumkörper**
- **Boron-Achse**
- Montage mit **Innen- und Außen-sechskantschlüssel** möglich
- mit **hochwertigem Polymer-Gleitlager**
- mit **Reflektoren**
- mit **deutschem Prüfzeichen**
- Trittläche: **84 x 90 mm** (L x B)

- **aluminium body**
- **boron axle**
- mounting possible with **allen key** and **open hex wrench**
- with **high quality polymer** plain bearing
- with **reflectors**
- with **German approval number**
- tread surface: **84 x 90 mm** (L x W)



312014 Montageverpackung

OEM

311134 auf M-Wave Eurolochkarte
11,90 €

on M-Wave eurohole card

ART.-NR. UVP **BESCHREIBUNG** **DESCRIPTION**

BMX-PEDAL ›FREEDOM PE‹

- aus **Polycarbonat**
- Trittfläche: 95 x 104 mm (L x B)

311135 Montageverpackung

311380 auf M-Wave Eurolochkarte
U
9,90 €

BMX PEDAL ›FREEDOM PE‹

- **polycarbonate** body
- tread surface: 95 x 104 mm (L x W)

OEM

on M-Wave eurohole card



Tested by the manufacturer based on ISO 4210



PLATTFORM-PEDAL

- Kunststoffkörper
- **anatomisch** geformte, konkave Auflagefläche
- **CrMo**-Achse
- mit 2 **Kugellagern**
- mit **deutschem Prüfzeichen**
- mit **Reflektoren**
- Montage auch mit **Innensechskant** möglich
- **XL**-Trittfläche: 106 x 101 mm (L x B)



FLAT PEDAL

- plastic body
- **anatomically** shaped concave supporting surface
- **CrMo** axle
- with 2 **ball bearings**
- with **German approval number**
- with **reflectors**
- mounting also possible with **allen key**
- **XL** tread surface: 106 x 101 mm (L x W)



313181 auf M-Wave Eurolochkarte
U

313180 Montageverpackung
6,90 €

on M-Wave eurohole card

OEM



Tested by the manufacturer based on ISO 4210

PLATTFORM-PEDAL ›STEADY K5‹

- Kunststoffkörper
- mit 2 **Kugellagern**
- mit **Reflektoren**
- Trittfläche: **96 x 95 mm** (L x B)

9/16" Achse

• **313310** Montageverpackung

311136 auf M-Wave Eurolochkarte

1/2" Achse

• **313311** Montageverpackung

311137 auf M-Wave Eurolochkarte
4,90 €

FLAT PEDAL ›STEADY K5‹

- plastic body
- with 2 **ball bearings**
- with **reflectors**
- tread surface: **96 x 95 mm** (L x W)

9/16" axle

OEM

on M-Wave eurohole card

1/2" axle

OEM

on M-Wave eurohole card



RENNRADPEDAL ›STEADY A11‹

- **Aluminiumkörper** und **-käfig**
- **CrMo**-Achse
- Pedalhaken nachrüstbar
- Trittfläche: 62 x 96 mm (L x B)

313461 Montageverpackung

311138 auf M-Wave Eurolochkarte
11,90 €

ROAD PEDAL ›STEADY A11‹

- **aluminium body** and **cage**
- **CrMo** axle
- toe clips attachable
- tread surface: 62 x 96 mm (L x W)

OEM

on M-Wave eurohole card



ART.-NR. UVP **BESCHREIBUNG**

DESCRIPTION

122900 U **PEDALTASCHE**
 ›ROTTERDAM PEDAL P‹
 9,90 €

- **2 Taschen für 1 Paar Pedale**
- aus Neopren
- als **Transporttaschen oder zum Schutz am Rad** verwendbar
- ca. 135 x 145 mm
- 1 Paar auf M-Wave Eurolochkarte

PEDAL BAG
 ›ROTTERDAM PEDAL P‹

- **2 bags for 1 pair of pedals**
- made of neoprene
- suitable as **transport bags or as protection on the bike**
- approx. 135 x 145 mm
- 1 pair on M-Wave eurohole card



311812 **SCHUHPLATTEN-SET** ›CLEAT S‹
 9,90 €

- **Shimano kompatibel** (kein original Shimano Ersatzteil)
- passend für Klick-Pedale Art. 311099/310/804/11/35/47/49/52/64/66/67/2060/1/2, ...
- mit Befestigungsteilen
- paarweise in M-Wave Blisterverpackung

CLEAT SET ›CLEAT S‹

- **Shimano compatible** (no original Shimano spare part)
- suitable for clipless pedals art. 311099/310/804/11/35/47/49/52/64/66/67/2060/1/2, ...
- with mounting parts
- one pair in M-Wave blister packaging



311836 **SCHUHPLATTEN-SET** ›CLEAT L‹
 9,90 €

- **Look Keo kompatibel**
- **5° seitliche Bewegungsfreiheit**
- mit Befestigungsteilen
- passend für Art. 311821/53/55, 313451, ...
- paarweise in M-Wave Blisterverpackung

CLEAT SET ›CLEAT L‹

- **Look Keo compatible**
- **5° lateral tolerance**
- with mounting parts
- suitable for art. 311821/53/55, 313451, ...
- one pair in M-Wave blister packaging



320070 U **SINGLE-SPEED-UMRÜSTKIT**
 14,90 €

zur Umrüstung von Shimano 8/9/10-fach Kassettennabe auf Single Speed

- 3 x Zahnkränze 14, 16 und 18 Zähne
- 2 x flexibel anbringbare Distanzringe (13,25 und 20,25 mm Breite) zur Optimierung der Kettenlinie durch 4 verschiedene Positionen
- auf M-Wave Eurolochkarte

SINGLE SPEED REFIT SET

for conversion from Shimano 8/9/10 speed cassette hub to single speed

- 3 x sprockets 14, 16 and 18 teeth
- 2 x flexibly attachable spacers (13.25 and 20.25 mm width) for optimizing the chain line through 4 different positions
- on M-Wave eurohole card



BOOST **STECKACHSE MIT HEBEL**

- **versenkbarer** Schnellspann-Hebel
- **Aluminium**
- Gewindesteigung 1,5 mm
- Montageverpackung

THRU AXLE WITH LEVER

- **hidden** QR lever
- **aluminium**
- thread pitch 1.5 mm
- OEM

321195 U ›Scrax B-12 148 QR‹
 36,90 €

55 g

- **Einbaumaß 148 mm**
- M12 x Länge 178 mm
- nur **55 g**
- Gewindelänge 18 mm
- z. B. für MTB- oder E-Bike-Rahmen Art. 613620 ff.

›Scrax B-12 148 QR‹

- **OLD 148 mm**
- M12 x length 178 mm
- only **55 g**
- thread length: 18 mm
- e. g. for MTB or e-bike frames art. 613620 et seq.



321138 U ›Scrax B-12 142 QR‹
 36,90 €

53 g



- **Einbaumaß 142 mm**
- M12 x Länge 157 mm
- nur **53 g**
- Gewindelänge 10 mm
- z. B. für Gravel-Rahmen Art. 666141-5

›Scrax B-12 142 QR‹

- **OLD 142 mm**
- M12 x length 157 mm
- only **53 g**
- thread length: 10 mm
- e. g. for Gravel frame art. 666141-5



ART.-NR. UVP	BESCHREIBUNG	DESCRIPTION	
321193 19,90 €	STECKACHSE ›SCRAX B-12 148‹ <ul style="list-style-type: none"> • Einbaumaß 148 mm • Boost Standard • 6 mm Innensechskant Fixierung • M12 x Länge 178 mm • Gewindesteigung: 1,5 mm • Gewindelänge: 20 mm • Montageverpackung 	THRU AXLE ›SCRAX B-12 148‹ <ul style="list-style-type: none"> • OLD 148 mm • boost standard • 6 mm allen screw fixation • M12 x length 178 mm • thread pitch: 1.5 mm • thread length: 20 mm • OEM 	

	SCHNELLSPANNER	QUICK RELEASE	
	Diebstahlschutz , da mit Innensechskant-Fixierung	theft protection due to allen screw fixation	
321116 4,90 €	<ul style="list-style-type: none"> • für Vorderradnabe • Einbaumaß: 100 mm • Montageverpackung 	<ul style="list-style-type: none"> • for front hub • OLD: 100 mm • OEM 	
321117 4,90 €	<ul style="list-style-type: none"> • für Hinterradnabe • Einbaumaß: 130-135 mm • Montageverpackung 	<ul style="list-style-type: none"> • for rear hub • OLD: 130-135 mm • OEM 	
321135 9,90 €	<ul style="list-style-type: none"> • Set für Vorder- und Hinterradnabe • Einbaumaße: 100 mm / 130-135 mm • auf M-Wave Eurolochkarte 	<ul style="list-style-type: none"> • set for front and rear hub • OLD: 100 mm / 130-135 mm • on M-Wave eurohole card 	



STECKACHSE FÜR ANHÄNGER-KUPPLUNG ›STALWART AXLE‹

- durch Innengewinde auch zur **Montage von Gepäckträgern an Steckachsen** geeignet
- zur **werkzeuglosen Montage von Standard Fahrrad-Anhänger-Kupplungen** an **12 mm Steckachs-naben**
- **2 in 1:** durch 6 mm Distanzscheibe passend für 12 mm Steckachs-naben mit **142 mm** Einbaumaß und für **Boost-Naben** mit **148 mm** Einbaumaß
- Aluminium
- mit Schnellspanner
- auch **ohne Schnellspanner als saubere Lösung** für Steckachsen nutzbar
- mit **zusätzlichem Innengewinde** für M6-Schraube für z. B. Gepäckträgermontage
- mit zusätzlichen Unterlegscheiben zur **Einstellung der Schnellspannhebel-Position**
- auf M-Wave Eurolochkarte

THRU AXLE FOR TRAILER MOUNT ›STALWART AXLE‹

- due to the internal thread also suitable for **mounting carriers to thru axles**
- for **toolless mounting of standard bicycle trailer adapters** at **12 mm thru axle hubs**
- **2 in 1:** by 6 mm spacer suitable for 12 mm thru axle hubs with OLD **142 mm** and for **boost hubs** with OLD **148 mm**
- aluminium
- with QR
- also usable **without QR as clean solution** for quick-release axle
- with **additional internal thread** for M6 screw for e. g. luggage rack mounting
- with additional spacers for **adjusting the QR lever position**
- on M-Wave eurohole card

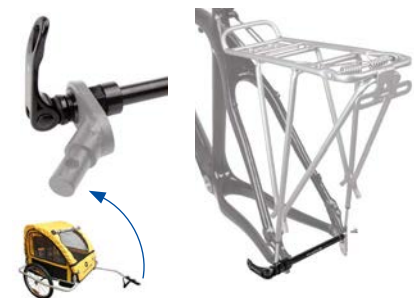

640140 U
44,90 €

- **Shimano Type** (kein original Shimano Ersatzteil)
- Gewindesteigung: P1.5 x T20

- **Shimano Type** (no original Shimano spare part)
- thread pitch: P1.5 x T20

640141 U
44,90 €

- **Maxle Type** (kein original Maxle Ersatzteil)
- Gewindesteigung: P1.75 x T20

- **Maxle Type** (no original Maxle spare part)
- thread pitch: P1.75 x T20

640142 U
44,90 €

- **Syntace Type** (kein original Syntace Ersatzteil)
- Gewindesteigung: P1.0 x T20
- mit konischer Verbindungsscheibe

- **Syntace Type** (no original Syntace spare part)
- thread pitch: P1.0 x T20
- with conical spacer

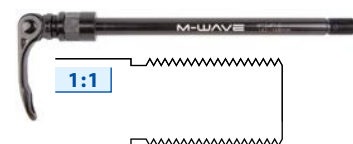
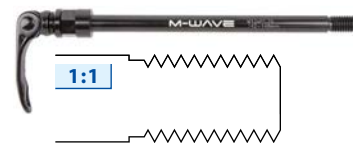

ART.-NR. BESCHREIBUNG
UVP

DESCRIPTION

440490 SCHNELLSPANNER

U
9,90 €

- zur Montage von Gepäckträgern an Räder:
- ohne Befestigungsösen (z. B. Rennräder)
- mit **hinderlichen Sitzrohr- oder Kettenstreben, Ausfallenden, ...**
- passend auch für **Fahrradhänger** Art. 640050, ...
- mit 8 je 5 mm breiten **Adapter-scheiben**
- **Aluminium**hebel
- Länge 210 mm
- für Nabeneinbaumaß: ≥ 130 mm
- **Einklembreite: 137 - 177 mm** (in 5 mm Schritten)
- auf M-Wave Eurolochkarte

QUICK RELEASE

- for mounting of carriers to bicycles:
- **without mounting eyelets** (e. g. road bikes)
- with **obstructive seat stays, chain stays, derailleur hangers, ...**
- also suitable for **bicycle trailer** art. 640050, ...
- with 8 **adapters**, each 5 mm wide
- **aluminium** lever
- length 210 mm
- OLD: ≥ 130 mm
- **clamp width: 137 - 177 mm** (in 5 mm steps)
- on M-Wave eurohole card

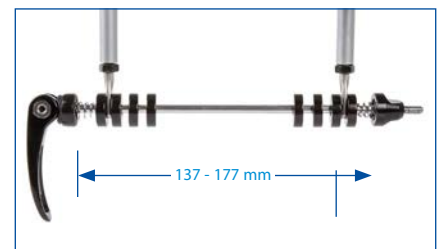

340250 EDELSTAHL-TRINKFLASCHE
›SBO 750‹

U
8,90 €



- 750 ml
- aus **Edelstahl**
- **umweltschützend**, da **wiederverwendbar**
- mit **Staubschutzkappenverschluss**
- mit **Dichtungsring**
- frei von Schadstoffen
- **geruchs- und geschmacksneutral**
- auf **M-Wave** Eurolochkarte

STAINLESS STEEL WATER BOTTLE ›SBO 750‹

- 750 ml
- made of **stainless steel**
- **environment-friendly**, because **reusable**
- with **protection cap**
- with **sealing ring**
- free of contaminants
- **odorless** and **neutral in taste**
- on **M-Wave** eurohole card



according to FDA

340295 ALUMINIUM-TRINKFLASCHE
›ABO 750‹

U
7,90 €







- 750 ml
- mit **Staubschutzkappenverschluss**
- mit **Dichtungsring**
- farbig sortiert
- auf **M-Wave** Eurolochkarte



ALUMINIUM WATER BOTTLE ›ABO 750‹

- 750 ml
- with **protection cap**
- with **sealing ring**
- assorted colours
- on **M-Wave** eurohole card



ART.-NR. UVP	BESCHREIBUNG	DESCRIPTION	
	 ISOLIER-/THERMOFLASCHE ›PBO 500-ISO‹ <ul style="list-style-type: none"> • 500 ml • modernes Design • aus hochwertigem Kunststoff • leichte Entnahme von Isolierung und Innenbehälter zur Reinigung • mit Staubschutzkappe • auf M-Wave Eurolochkarte 	INSULATED/THERMO BOTTLE ›PBO 500-ISO‹ <ul style="list-style-type: none"> • 500 ml • modern design • high quality plastic • easy removal of insulation and inner container for cleaning • with protection cap • on M-Wave eurohole card 	
340450	schwarz	black	
340452	weiß 9,90 €	white	

	 ISOLIER-/THERMOFLASCHE ›PBO 400-ISO‹ <ul style="list-style-type: none"> • 400 ml • aus transparentem Kunststoff • mit Isolierfolie • mit abnehmbarem Staubschutzkappenverschluss • auf M-Wave Eurolochkarte 	INSULATED/THERMO BOTTLE ›PBO 400-ISO‹ <ul style="list-style-type: none"> • 400 ml • made of transparent plastic • with insulating foil • with detachable protection cap • on M-Wave eurohole card 	
340340	schwarz U	black	
340346	gelb 9,90 €	yellow	

	 TRINKFLASCHE ›PBO 700-NS‹ <ul style="list-style-type: none"> • 700 ml • mit Anti-Rutsch-Einlage • aus hochwertigem Kunststoff • abnehmbarer Staubschutzkappenverschluss • silber/schwarz • mit Skala • auf M-Wave Eurolochkarte 	WATER BOTTLE ›PBO 700-NS‹ <ul style="list-style-type: none"> • 700 ml • with non-slip inlay • high quality plastic • detachable protection cap • silver/black • with scale • on M-Wave eurohole card 	
340351	U 6,90 €		
	 NON SLIP		

	 TRINKFLASCHE ›PBO 600-NS‹ <ul style="list-style-type: none"> • 600 ml • mit Anti-Rutsch-Einlage • aus hochwertigem Kunststoff • mit Staubschutzkappenverschluss • auf M-Wave Eurolochkarte 	WATER BOTTLE ›PBO 600-NS‹ <ul style="list-style-type: none"> • 600 ml • with non-slip inlay • high quality plastic • with protection cap • on M-Wave eurohole card 	
340365	weiß/schwarz U	white/black	
340366	silber/schwarz U 6,90 €	silver/black	

ART.-NR. UVP	BESCHREIBUNG	DESCRIPTION
-----------------	--------------	-------------



TRINKFLASCHE

- aus **hochwertigem Kunststoff**
- mit weichem **Big Flow Mundstück**
- auf M-Wave Eurolochkarte

WATER BOTTLE

- **high quality plastic**
- with soft **big flow bite valve**
- on M-Wave eurohole card

1.000 ml

›PBO 1000€, 1.000 ml, mit Skala

›PBO 1000€, 1,000 ml, with scale

340440
5,90 €

schwarz

black

340442
5,90 €
100

weiß

white



750 ml

›PBO 750€, 750 ml, mit Skala

›PBO 750€, 750 ml, with scale

340420
U
4,90 €

schwarz

black

340421
U
4,90 €

schwarz transparent

black transparent

340422
U
4,90 €

weiß

white

340423
4,90 €

transparent

transparent

340424
4,90 €

blau transparent

blue transparent

100



550 ml

›PBO 550€, 550 ml, mit Skala

›PBO 550€, 550 ml, with scale

340425
3,90 €

schwarz

black

340426
3,90 €

schwarz transparent

black transparent

340427
3,90 €

weiß

white

340428
3,90 €

transparent

transparent

340429
3,90 €

blau transparent

blue transparent

100



350 ml

›PBO 350€, 350 ml

›PBO 350€, 350 ml

340430
3,90 €

schwarz

black

340432
3,90 €

weiß

white

100



ART.-NR. UVP	BESCHREIBUNG	DESCRIPTION	
<p>340908</p> <p>24,90 €</p>  <p>19 g</p> 	<p>FLASCHENHALTER ›BC 19-C‹</p> <ul style="list-style-type: none"> • modernes und funktionelles Design • carbonfaserverstärkter Kunststoff • superleicht, nur 19 g • inkl. Befestigungsschrauben • auf M-Wave Eurolochkarte 	<p>BOTTLE CAGE ›BC 19-C‹</p> <ul style="list-style-type: none"> • modern and functional design • carbon fiber composite plastic • super light, only 19 g • incl. fixing screws • on M-Wave eurohole card 	
<p>340707</p> <p>6,90 €</p>  <p>30 g</p>	<p>FLASCHENHALTER ›BC 30-K‹</p> <ul style="list-style-type: none"> • modernes und funktionelles Design • hochwertiger Kunststoff • nur 30 g • leichtes Herausnehmen und Einführen der Flasche durch abgerundete Kanten • inkl. Befestigungsschrauben • auf M-Wave Eurolochkarte 	<p>BOTTLE CAGE ›BC 30-K‹</p> <ul style="list-style-type: none"> • modern and functional design • high quality plastic • only 30 g • easy placement and removal of the bottle by rounded brims • incl. fixing screws • on M-Wave eurohole card 	
<p>341020</p> <p>32,90 €</p>	<p>FLASCHENHALTER MIT MULTITOOL ›BC 99 TOOL‹</p> <ul style="list-style-type: none"> • mit integriertem Multitool (9 Funktionen) • Carbonfaserverstärkter Kunststoff • nur 99 g inkl. Multitool • inkl. Befestigungsschrauben • auf M-Wave Eurolochkarte 	<p>BOTTLE CAGE WITH MULTITOOL ›BC 99 TOOL‹</p> <ul style="list-style-type: none"> • with integrated multitool (9 functions) • carbon fiber reinforced plastic • only 99 g incl. multitool • incl. fixing screws • on M-Wave eurohole card 	
<p>340720</p> <p>8,90 €</p>   <p>44 g</p>	<p>FLASCHENHALTER ›BC VARIO SIDE‹</p> <ul style="list-style-type: none"> • Montageadapter ermöglicht links- wie auch rechtsseitige Einführung und Entnahme der Flasche. Dadurch besonders geeignet für E-Bike Rahmengeometrien mit eingeschränktem Platz • hochwertiger Kunststoff • nur 44 g • leichtes Herausnehmen und Einführen der Flasche durch nach außen abgerundete Kanten • universelle Passform • inkl. Befestigungsschrauben • auf M-Wave Eurolochkarte 	<p>BOTTLE CAGE ›BC VARIO SIDE‹</p> <ul style="list-style-type: none"> • mounting adapter enables the bottle to be placed and removed from the left and the right side. Therefore particularly suitable for e-bike frame geometries with limited space • high quality plastic • only 44 g • easy placement and removal of the bottle by to the outside rounded brims • universal fitting • incl. fixing screws • on M-Wave eurohole card 	
<p>340916</p> <p>5,90 €</p>  <p>21 g</p>	<p>FLASCHENHALTER ›BC 21‹</p> <ul style="list-style-type: none"> • hochwertiger Kunststoff • nur 21 g • leichtes Herausnehmen und Einführen der Flasche durch abgerundete Kanten • gute Passform durch flexible Seitenteile • Non-Slip Gummieinlage erschwert das Herausfallen der Flasche • auf M-Wave Eurolochkarte 	<p>BOTTLE CAGE ›BC 21‹</p> <ul style="list-style-type: none"> • high quality plastic • only 21 g • easy placement and removal of the bottle by rounded brims • good fitting because of flexible side parts • non-slip rubber prevents the bottle from falling out • on M-Wave eurohole card 	

Bottles

ART.-NR. UVP **BESCHREIBUNG**

DESCRIPTION

340790 U **FLASCHENHALTER ›BC VARIO‹**

5,90 €

- fast **unzerstörbares**, hochwertiges, schwarzes Nylonmaterial
- Trinkflasche sowohl **von oben**, als auch **von vorne** einsteckbar
- inklusive 2 Befestigungsschrauben
- auf M-Wave Eurolochkarte

BOTTLE CAGE ›BC VARIO‹

- almost **indestructible**, high quality, black nylon
- water bottle can be put in **from top or front side**
- incl. 2 mounting screws
- on M-Wave eurohole card



340719 U **FLASCHENHALTER ›BC 33‹**

4,90 €



- **hochwertiges**, schwarzes **Nylonmaterial**
- Flasche kann leicht von Rechts- und Linkshändern entnommen werden
- **flexible** und universelle Anpassung an verschiedene Flaschenformen
- leichtes **Einführen und Herausnehmen** der Flasche durch nach außen abgerundete Ränder
- nur **33 g**
- inkl. Befestigungsschrauben
- auf M-Wave Eurolochkarte

BOTTLE CAGE ›BC 33‹

- **high quality**, black **nylon**
- bottle can be easily taken out from right- and left-handers
- **flexible** and universal adaptation to different bottle forms
- outward chamfered edges make **placing and removing** of the bottle easier
- only **33 g**
- incl. fixing screws
- on M-Wave eurohole card

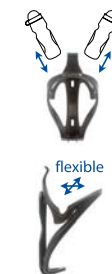

FLASCHENHALTER

- besonders geeignet für **E-Bike Rahmengeometrien** mit eingeschränktem Platz
- nach außen gebogene Ränder **erleichtern** das Einführen der Flasche
- mit Befestigungsschrauben
- auf M-Wave Eurolochkarte

BOTTLE CAGE

- especially suitable for **e-bike frame geometries** with limited space
- outward chamfered edges **make it easier** to put in the bottle
- with mounting screws
- on M-Wave eurohole card



340051 U **›BC 29 Side‹**

- Flasche kann **auch von der Seite** leicht eingeführt und entnommen werden
- nur 29 g

›BC 29 Side‹

- bottle can be easily put in and taken away, also **from the side**
- only 29 g

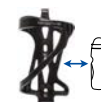

340053 U **›BC 26 Side‹**

4,90 €



- Flasche kann auch **schräg von der Seite** leicht eingeführt und entnommen werden
- nur 26 g

›BC 26 Side‹

- bottle can be easily put in and taken away, also **diagonal from the side**
- only 26 g



ART.-NR. BESCHREIBUNG
UVP

DESCRIPTION



FLASCHENHALTER ›BC 47 A‹

- Aluminium
- nur **47 g**
- Flasche kann **leicht entnommen** werden
- **leichtes Einführen** der Flasche durch leicht nach außen gebogene Ränder
- inkl. Befestigungsschrauben
- auf M-Wave Eurolochkarte

BOTTLE CAGE ›BC 47 A‹

- aluminium
- only **47 g**
- bottle can be **easily taken away**
- outward chamfered edges make **placing the bottle easier**
- incl. fixing screws
- on M-Wave eurohole card

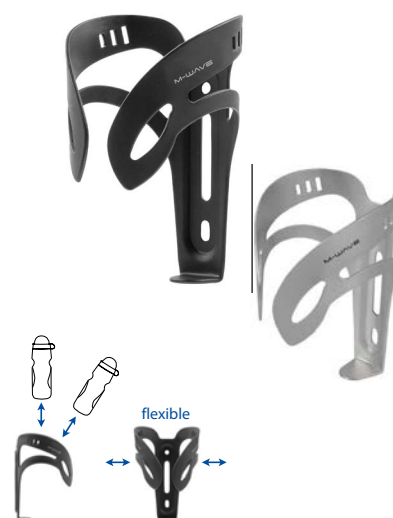

340884 schwarz

black

340889 silber
5,90 €

silver

FLASCHENHALTER ›BC 54 A‹

- mit **Knopf** für **besseren Halt** und **Schutz** der Flasche
- nur 54 g
- inkl. Befestigungsschrauben
- auf M-Wave Eurolochkarte

BOTTLE CAGE ›BC 54 A‹

- with **knob** for **better fixation** and **protection** of the bottle
- only 54 g
- incl. fixing screws
- on M-Wave eurohole card



340965 schwarz
U

black

340966 silber
U
4,90 €

silver

340018 **FLASCHENHALTER ›BC 45‹**
U
4,90 €

- **Aluminium** und hochwertiger Kunststoff
- nur 45 g
- guter Halt der Flasche durch **flexibles Rückenteil**
- mit Befestigungsschrauben
- auf M-Wave Eurolochkarte

BOTTLE CAGE ›BC 45‹

- **aluminium** and high quality plastic
- only 45 g
- good hold of the bottle due to **flexible back part**
- with mounting screws
- on M-Wave eurohole card



FLASCHENHALTER

- Aluminium
- mit **Knopf** für **besseren Halt** und **Schutz** der Flasche
- 6 mm
- Montageverpackung

BOTTLE CAGE

- aluminium
- with **knob** for **better fixation** and **protection** of the bottle
- 6 mm
- OEM

340938 schwarz
U

black

340939 silber
U
3,90 €

silver



ART.-NR. UVP BESCHREIBUNG DESCRIPTION

FLASCHENHALTER

- Aluminium
- 6 mm
- Montageverpackung

• **340883** U schwarz

• **340882** U silber

• **340842** U weiß

• **340843** U rot

• **340844** U blau

• **340845** U grün

• **340847** U orange/gold

• **340848** U pink
3,90 €

BOTTLE CAGE

- aluminium
- 6 mm
- OEM

black

silver

white

red

blue

green

orange/gold

pink

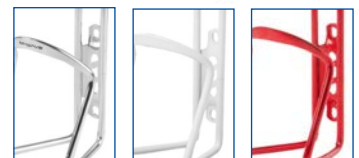

340927 U FLASCHENHALTER

›BC PET 500 A‹

5,90 €



- nur **31 g**
- passend auch für (PET)-Flaschen mit **500 ml** Volumen
- Durchmesser 64 - 66 mm
- schwarz
- auf M-Wave Eurolochkarte

BOTTLE CAGE

›BC PET 500 A‹

- only **31 g**
- also suitable for (PET) bottles with **500 ml** volume
- diameter 64 - 66 mm
- black
- on M-Wave eurohole card

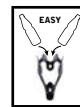

FLASCHENHALTER ›BC 32 FLEX‹

- hochwertiger Kunststoff
- sehr **flexibel**, passt sich Flaschen von **0,33 l - 1,5 l** Volumen an
- nur **32 g**



BOTTLE CAGE ›BC 32 FLEX‹

- high quality plastic
- very **flexible**, suitable for bottles with **0.33 l up to 1.5 l** volume
- only **32 g**

340725 auf M-Wave Eurolochkarte

on M-Wave eurohole card

340726 Montageverpackung

3,90 €

OEM



FLASCHENHALTER ›BC 360°‹

- hochwertiger, schwarzer Kunststoff
- mit **drehbarer Schelle**, werkzeuglose Montage am Rahmen, Lenkerbügel, ...
- mit **Schnellspanner** möglich (ca. Ø 16 - 32 mm)
- auch passend für die meisten 0,7 - 1,0 Liter Flaschen



BOTTLE CAGE ›BC 360°‹

- high grade, black plastic
- with **turnable clamp**, toolless mounting at the frame, handlebar, ...
- with **QR** (approx. Ø 16 - 32 mm)
- also suitable for the most 0.7 - 1.0 litre bottles

340950 U auf M-Wave Eurolochkarte

on M-Wave eurohole card

340951 Modell ›Eco‹

6,90

- im Polybeutel, ohne Logo

model ›Eco‹

- in PE bag, w/o logo



ART.-NR. BESCHREIBUNG
UVP

DESCRIPTION

340150 BECHERHALTER ›TO GO‹

U
5,90 €

- **universell** passend für handelsübliche **Trinkflaschen, Kaffeebecher, ...**
- mit Anti-Rutsch-Einlage
- mit Befestigungsklemme für Ø 22,2 – 25,4 mm
- aus Aluminium
- auf M-Wave Eurolochkarte

CUPHOLDER ›TO GO‹

- **universally** suitable for customary **bottles, coffee mugs, ...**
- with non slip insole
- with fastening clamp for Ø 22.2 – 25.4 mm
- made of aluminium
- on M-Wave eurohole card



340041 FLASCHENHALTER-ADAPTER ›ADA BC FLEX 2‹

U
8,90 €



- zur universellen Montage eines Flaschenhalters an unterschiedlichen Stellen, bei **verschiedensten Rahmengeometrien** oder bei eingeschränktem Platz an E-Bikes
- schnelle und flexible **Montagemöglichkeiten durch** non-slip Klettänder (Art. 340042)
- 1 Set = 1 Paar Adapter, 1 Paar Klettänder
- auf M-Wave Eurolochkarte

BOTTLE CAGE ADAPTER ›ADA BC FLEX 2‹

- for universal mounting of a bottle cage at different places, at **most different frame geometries** or for e-bikes with little space for bottle cage mounting
- fast and flexible **mounting possibilities** by non-slip hook and loop fasteners (art. 340042)
- 1 set = 1 pair of adapters, 1 pair of Velcro straps
- on M-Wave eurohole card



340042 UNIVERSALBEFESTIGUNGS-BAND

U
0,99 €

- Klettband
- mit **Silikon-Antirutsch-Streifen**
- Länge: 25 cm, Breite: 2 cm
- Montageverpackung

UNIVERSAL MOUNTING TAPE

- hook and loop fastener
- with **silicone non-slip stripes**
- length: 25 cm, width: 2 cm
- OEM



340013 FLASCHENHALTER-ADAPTER ›ADA SLIDE‹

U
9,90 €



- zur optimalen Montage eines Flaschenhalters bei **verschiedensten Rahmengenometrien** oder bei eingeschränktem Platz an E-Bikes
- **90 mm (+/- 45 mm) Verstellbereich** in der Höhe
- aus Aluminium
- inkl. Befestigungsmaterial
- in M-Wave Eurolochbox

BOTTLE CAGE ADAPTER ›ADA SLIDE‹

- for optimal mounting of a bottle cage at **most different frame geometries** or for e-bikes with little space for bottle cage mounting
- **90 mm (+/- 45 mm) height adjustment range**
- made of aluminium
- incl. fixing material
- in M-Wave eurohole box

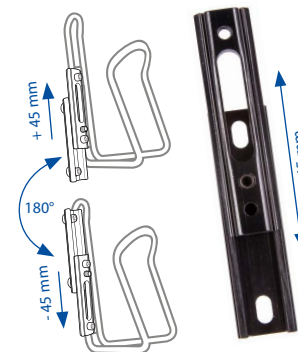

340015 FLASCHENHALTER-ADAPTER ›ADA TWO‹

U
8,90 €

- zur Befestigung von **2 Flaschenhaltern** an einer Flaschenhalteraufnahme
- **seitliche Befestigung** von Flaschenhaltern möglich, auch bei Rahmengeometrien mit **Platzproblemen**
- aus **Aluminium**
- nur **9 g**
- auf M-Wave Eurolochkarte

BOTTLE CAGE ADAPTER ›ADA TWO‹

- for assembling of **2 bottle cages** at one bottle cage eyelet
- bottle cages can be **sloped to the sides**, also for frames that leave **little space** for bottle cages
- made of **Aluminium**
- only **9 g**
- on M-Wave eurohole card



ART.-NR. BESCHREIBUNG
UVP

DESCRIPTION

340046 FLASCHENHALTER ADAPTER

24,90 €

- ›ADA S III‹
- zur Montage von zwei **Flaschenhaltern am Sattelgestell**
 - zusätzliche **Stabilisierung großer Satteltaschen**, z.B. Art. 122630/6
 - Aluminium
 - stabile Klemmbefestigung
 - auf M-Wave Eurolochkarte

BOTTLE CAGE ADAPTER

›ADA S III‹

- for mounting of two **bottle cages at the saddle rails**
- additional **stabilization of big saddle bags**, e.g. art. 122630/6
- aluminium
- stable clamp attachment
- on M-Wave eurohole card

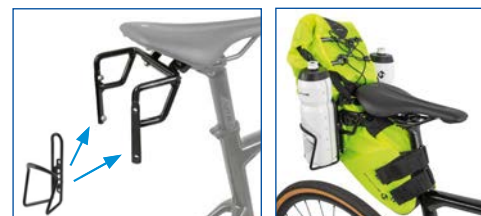

340019 FLASCHENHALTER-ADAPTER

8,90 €

360°

- ›ADA FLEX‹
- zur Montage von **Flaschenhaltern an beliebigen Rohren** (z. B. Vorbau, Sitzrohr, Sattelstütze, Lenker, ...)
 - mit **3 Nirosta-Halteschellen** für 19 - 22,4 mm, 22,4 - 27 mm und 28,6 - 31,8 mm Rohrdurchmesser
 - mit **werkzeuglos abnehmbarem Halter**
 - passend für **alle gängigen Flaschenhalter**
 - auf M-Wave Eurolochkarte

BOTTLE CAGE ADAPTER

›ADA FLEX‹

- for assembling a **bottle cage at any tubes** (e. g. stem, seat tube, seat post, handlebar, ...)
- with **3 stainless steel clamps** for tube diameter 19 - 22.4 mm, 22.4 - 27 mm und 28.6 - 31.8 mm
- with **toolless disassembling bracket**
- usable for **all current bottle cages**
- on M-Wave eurohole card



340017 FLASCHENHALTER-ADAPTER

4,90 €

90°

- ›ADA T90‹
- zur Montage eines **Flaschenhalters am Lenker**, Sattelstütze, ...
 - Aluminium
 - für Lenkerdurchmesser 22,2 - 25,4 mm
 - inkl. Edelstahlbefestigungsschrauben
 - auf M-Wave Eurolochkarte

BOTTLE CAGE ADAPTER

›ADA T90‹

- for mounting of a **bottle cage at the handlebar**, seat post, ...
- aluminium
- for handlebar diameter 22.2 - 25.4 mm
- incl. stainless steel fixing screws
- on M-Wave eurohole card



122830 FLASCHENHALTER-TASCHE

16,90 €



- ›GRONINGEN BC‹
- inkl. Aluminium-Adapter zur Befestigung an den Flaschenhalterösen (unter dem Flaschenhalter)
 - **wasserdicht**
 - mit Innentasche für z. B. Kettenverschlussglieder, ...
 - Tasche kann leicht (de-)montiert werden
 - Adapter kann auch nur mit Klettbindern (z. B. Art. 340042) genutzt werden
 - Größe: ca. 11,0 x 7,5 x 6,5 cm (L x B x H)
 - auf M-Wave Eurolochkarte

BOTTLE CAGE BAG

›GRONINGEN BC‹



- incl. aluminium adapter for mounting to the bottle cage eyelets (below the bottle cage)
- **waterproof**
- with inner bag for e. g. chain links, ...
- bag can easily be (de-)mounted
- bracket can also be used only with hook and loop straps (e. g. art. 340042)
- size: approx. 11.0 x 7.5 x 6.5 cm (L x B x H)
- on M-Wave eurohole card



ART.-NR. UVP	BESCHREIBUNG	DESCRIPTION	
	 KETTENRADGARNITUR <ul style="list-style-type: none"> • 22/32/44 Zähne • für 27 (und 24) Gang • Stahl/Stahl/Aluminiumkettenblätter, auswechselbar • Lochkreis: 64 mm (22 Z.), 104 mm (32/44 Z.) • JIS • Innenlagerlänge: 119 mm • Montageverpackung 	CHAINWHEEL SET <ul style="list-style-type: none"> • 22/32/44 teeth • for 27 (and 24) speed • steel/steel/aluminium chainrings, re-placeable • bolt circle: 64 mm (22 t.), 104 mm (32/44 t.) • JIS • B.B. set length: 119 mm • OEM 	
351234 AD	<ul style="list-style-type: none"> • polierte Aluminiumkurbel • Kurbellänge: 170 mm 	<ul style="list-style-type: none"> • polished aluminium crank • crank length: 170 mm 	
351235 AD 37,90 € mAD 55,90 €	<ul style="list-style-type: none"> • schwarze Kurbel • Kurbellänge: 175 mm • schwarzes Kettenblatt, 44 Zähne 	<ul style="list-style-type: none"> • black crank • crank length: 175 mm • black chainring, 44 teeth 	<p>Tested by the manufacturer based on ISO 4210</p>

ART.-NR. UVP	BESCHREIBUNG	DESCRIPTION	
	 KETTENRADGARNITUR <ul style="list-style-type: none"> • 22/32/42 Zähne • für 24 (und 21) Gang • polierte Aluminiumkurbel • Kurbellänge: 170 mm • JIS • silberne, auswechselbare Stahlkettenblätter • Lochkreis: 64 mm • Innenlagerlänge: 107 mm • Montageverpackung 	CHAINWHEEL SET <ul style="list-style-type: none"> • 22/32/42 teeth • for 24 (and 21) speed • polished aluminium crank • crank length: 170 mm • JIS • silver, replaceable steel chainrings • bolt circle: 64 mm • B.B. set length: 107 mm • OEM 	
• 351236 AD 26,90 € mAD 38,90 €	ohne Kettenschutz	without chainguard	
• 351237 AD 27,90 € mAD 39,90 €	mit Kettenschutz	with chainguard	

ART.-NR. UVP	BESCHREIBUNG	DESCRIPTION	
351240 AD 27,90 € mAD 39,90 €	KETTENRADGARNITUR <ul style="list-style-type: none"> • 26/38/48 Zähne • für 24 (und 21) Gang • polierte Aluminiumkurbel • Kurbellänge: 170 mm • JIS • silberne, auswechselbare Stahlkettenblätter • mit transparentem Kettenschutz • Lochkreis: 64 mm • Innenlagerlänge: 107 mm • Montageverpackung 	CHAINWHEEL SET <ul style="list-style-type: none"> • 26/38/48 teeth • for 24 (and 21) speed • polished aluminium crank • crank length: 170 mm • JIS • silver, replaceable steel chainrings • with transparent chainguard • bolt circle: 64 mm • B.B. set length: 107 mm • OEM 	

ART.-NR. UVP	BESCHREIBUNG	DESCRIPTION	
	 KETTENRADGARNITUR <ul style="list-style-type: none"> • polierte Aluminiumkurbel • schwarzes, austauschbares CNC gefrästes Aluminium Kettenblatt • Lochkreis: 130 mm • Kurbellänge: 165 mm • JIS • 1/2" x 1/8" • Kettenlinie: 45 mm • Innenlagerlänge: 110,5 mm • silber/schwarz • Montageverpackung 	CHAINWHEEL SET <ul style="list-style-type: none"> • polierte aluminium crank • black, replaceable CNC-machined aluminium chainring • bolt circle: 130 mm • crank length: 165 mm • JIS • 1/2" x 1/8" • chain line: 45 mm • B.B. set length: 110.5 mm • silver/black • OEM 	
350630 AD	46 Zähne	46 teeth	
350640 AD 35,90 € mAD 52,90 €	44 Zähne	44 teeth	<p>Tested by the manufacturer based on ISO 4210</p>

ART.-NR. UVP **BESCHREIBUNG**

DESCRIPTION

KETTENRADGARNITUR

- geschmiedete, polierte **Aluminiumkurbel**
- Kurbellänge: 170 mm
- JIS
- silbernes Stahlkettenblatt
- 1/2" x 3/32"
- Innenlagerlänge: 131 mm
- Montageverpackung

CHAINWHEEL SET

- forged, polished **aluminium crank**
- crank length: 170 mm
- JIS
- silver steel chainring
- 1/2" x 3/32"
- B.B. set length: 131 mm
- OEM



- **350650** AD 46 Zähne
 - **350651** AD 44 Zähne
 - **350652** AD 38 Zähne
 - **350653** AD 33 Zähne
- 19,90 €
mAD 28,90 €

- 46 teeth
- 44 teeth
- 38 teeth
- 33 teeth

Tested by the manufacturer based on ISO 4210



KETTENBLÄTTER

- schwarz
- Lochkreis 104 mm
- für Brose, Bosch, Shimano, ...
- für Schaltungsketten 1/2 x 3/32" & 11/128"
- gerade, nicht gekröpft

CHAINRINGS

- black
- BCD 104 mm
- for Brose, Bosch, Shimano, ...
- for 1/2 x 3/32" & 11/128" chains
- 0 offset

M-WAVE
by **SAMOX**



32 - 40 Zähne / teeth



42 - 46 Zähne / teeth

Zähne / teeth	Stahl steel		Stahl / Narrow Wide steel / narrow wide		Aluminium / Narrow Wide aluminium / narrow wide	
	AM	OEM	AM	OEM	AM	OEM
32			356213	356202	356243	356238
34			356214	356230	356244	356229
36	356204 _U	356201	356215	356203	356245	356239
UVP	9,90 €	9,90 €	19,90 €	19,90 €	29,90 €	29,90 €
38	352682 _U	352685	356216	356232	356246	356231
40	356205 _U	356220	356217	356235	356247	356240
42	352683 _U	352686	356218	356236	356248	356241
44	352684 _U	352687	356219	356226		
46	356206 _U	356228	356242	356237		
UVP	9,90 €	9,90 €	24,90 €	24,90 €	36,90 €	36,90 €
	50	50	50	50	50	50

Chainwheel Sets



ART.-NR. UVP **BESCHREIBUNG**

DESCRIPTION

DIRECT MOUNTS

- schwarz
- für Schaltungsketten 1/2 x 3/32" & 11/128"
- Stahl

DIRECT MOUNTS

- black
- for 1/2 x 3/32" & 11/128" chains
- steel

M-WAVE
by **SAMCOX**

Zähne / teeth	Bosch* GEN 2		Bosch* GEN 3 Kettenlinie / chainline 47 mm		Bosch* GEN 4 Kettenlinie / chainline 50 mm Narrow Wide	
	AM	OEM	AM	OEM	AM	OEM
15	356264	356263				
16	356283	356281				
17	356284	356282				
34					356252	356210
36					356253	356211
38			356249	356207	356254	356212
40			356250	356208		
42			356251	356209		
UVP	4,90 €	4,90 €	9,90 €	9,90 €	24,90 €	24,90 €
	100	100	50	50	80	50



Bosch GEN 2



Bosch GEN 3



Bosch GEN 4

Weitere Größen und Designs auf Wunsch erhältlich.

*kein original Bosch Ersatzteil

Other sizes and designs available on request

*no original Bosch spare part

KETTENSCHUTZ

- Aluminium
- schwarz eloxiert
- Lochkreis 104 mm

CHAIN GUARD

- aluminium
- black anodized
- bolt circle 104 mm

M-WAVE
by **SAMCOX**

Zähne / teeth	CHAINGUARD 104		CHAINGUARD 104SL		CHAINGUARD 104CNC	
	AM	OEM	AM	OEM	AM	OEM
36					356256	356278
38					356257	356279
40	356255	356273			356258	356280
42			356261	356272		
44			356259	356275		
46			356260	356276		
48				356274		
UVP	12,90 €	12,90 €	13,90 €	13,90 €	20,90 €	20,90 €
	100	20	30	50	100	50



Chain Guard 104



Chain Guard 104SL



Chain Guard 104CNC

ART.-NR. UVP
BESCHREIBUNG

DESCRIPTION



KETTENBLATTSCHRAUBEN

CHAINRING BOLTS

M-WAVE
by SAMOX

	AM (4 Stück auf M-Wave Karte)	OEM
M8 x 0,75 x L8,5 mm (Verwendung ohne Kettenschutz / usage without chainguard)	356304	356300
M8 x 0,75 x L9,5 mm (Verwendung ohne Kettenschutz / usage without chainguard)	356305	356301
M8 x 0,75 x L10,5 mm (Verwendung mit und ohne Kettenschutz / usage with and without chainguard)	356306	356302
M8 x 0,75 x L12,5 mm (Verwendung mit Kettenschutz / usage with chainguard)	356307	356303
UVP	2,99 € / Set	0,69 € / St
	100	1.000/40



KETTENBLATTMUTTERN

CHAINRING NUTS

	AM (4 Stück auf M-Wave Karte)	OEM
M8 x 0,75 x L5,5 mm (Verwendung ohne Kettenschutz / usage without chainguard)	356310	356308
M8 x 0,75 x L8,5 mm (Verwendung mit Kettenschutz / usage with chainguard)	356311	356309
UVP	2,99 € / Set	0,69 € / St
	100	1.000/40

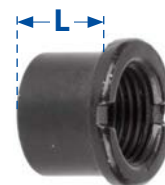

SET AUS KETTENBLATT-SCHRAUBEN UND KETTENBLATTMUTTERN

SET OF CHAINRING BOLTS AND CHAINRING NUTS

356291 Set aus 4x Schraube M8 x 8,5 mm und 4x Mutter M8 x 5,5 mm, für Kettenradgarnituren ohne Kettenschutz, im Polybeutel

set of 4x screw M8 x 8.5 mm and 4x nut M8 x 5.5 mm, for chainwheel sets without chain guard, in PE bag

356293 Set aus 4x Schraube M8 x 10,5 mm und 4x Mutter M8 x 8,5 mm, für Kettenradgarnituren mit Kettenschutz, im Polybeutel
4,99 €



set of 4x screw M8 x 10.5 mm and 4x nut M8 x 8.5 mm, for chainwheel sets with chain guard, in PE bag







Weitere Größen und Designs auf Wunsch erhältlich.

Other sizes and designs available on request.

ART.-NR. UVP	BESCHREIBUNG	DESCRIPTION	
	KURBELENSCHUTZ ›CRANK BOOTS‹ <ul style="list-style-type: none"> zum Schutz gegen Steinschlag, Verkratzen, ... schlagfestes und langlebiges Material leichte und schnelle Montage auf M-Wave Eurolochkarte 	CRANK PROTECTION ›CRANK BOOTS‹ <ul style="list-style-type: none"> protection against stone chipping, scratching, ... impact resistant and durable material easy and fast mounting on M-Wave eurohole card 	
352730	schwarz	black	
352731	rot	red	
	4,90 €		

352654 U 15,90 € 	KETTENSCHUTZ ›CHAIN CAGE‹ <ul style="list-style-type: none"> Clip-on Ketten- und Hosenschutz für 1/2" x 1/8" Ketten ohne Schaltwerk wird direkt auf die Kette montiert, muss nicht am Rad befestigt werden werkzeuglose und schnelle Montage geräuschreduziert 120 Glieder im M-Wave Einzelkarton 	CHAINSLIDER ›CHAIN CAGE‹ <ul style="list-style-type: none"> clip-on chain and trousers protection for 1/2" x 1/8" chains w/o rear derailleur mounted directly on the chain, no need to be fixed at the bike toolless and quick mounting noise reduced 120 links in M-Wave box 	
--	---	---	--

	KETTENSCHUTZSCHEIBE <ul style="list-style-type: none"> verschiedene Befestigungsmöglichkeiten: am Gewinde für Staubschutzkappe Konusbefestigung (Hollowtech II) aus Kunststoff schwarz inkl. Befestigungsmaterial Montageverpackung 	CHAIN GUARD <ul style="list-style-type: none"> multiple mounting positions: at dust cap thread cone fixation (Hollowtech II) made of plastic black incl. mounting material OEM 	
352648	42 - 44 Zähne	42 - 44 teeth	
352649	46 - 48 Zähne	46 - 48 teeth	
	6,90 €		

	›CAROUSEL BB BSA SQ‹ <ul style="list-style-type: none"> CrMo-Hohlachse, Dacromet beschichtet Aluminiumschalen mit Lockseal nur 218 g (107,5 mm) im M-Wave Karton 	›CAROUSEL BB BSA SQ‹ <ul style="list-style-type: none"> CrMo hollow axle, Dacromet coated aluminium cups with lockseal only 218 g (107.5 mm) in M-Wave box 	
	L1 / L2	L1 / L2	
359450	107,5/20,5 mm	107.5/20.5 mm	
359451	110,5/20,5 mm	110.5/20.5 mm	
359452	113,5/23 mm	113.5/23 mm	
359453	115/24 mm	115/24 mm	
359454	119/27 mm	119/27 mm	
359455	122,5/28,5 mm	122.5/28.5 mm	
359456	127,5/31 mm	127.5/31 mm	
359457	131/34 mm	131/34 mm	
	14,90 €		

ART.-NR. UVP	BESCHREIBUNG	DESCRIPTION
	FAT BIKE INNENLAGER ›CAROUSEL BB BSA SQ FAT‹ <ul style="list-style-type: none"> • silberne, Dacromet beschichtete Achse • silberne Schalen • rostschutzbeschichtete Achsschrauben mit Dichtungsring und Lockseal • im M-Wave Einzelkarton 	FAT BIKE BOTTOM BRACKET ›CAROUSEL BB BSA SQ FAT‹ <ul style="list-style-type: none"> • silver, Dacromet coated axle • silver cups • antirust coated axle bolts with sealing ring and lockseal • in M-Wave box
359438 U	<ul style="list-style-type: none"> • für 120 mm Innenlagergehäuse • L1: 179,5 mm, L2: 28,7 mm (mit Adapterring (2,5 mm) auf 31,2 mm verlängerbar) 	<ul style="list-style-type: none"> • for 120 mm bottom bracket housing • L1: 179.5 mm, L2: 28.7 mm (with adaptor ring (2.5 mm) extendable to 31.2 mm)
359439 11,90 €	<ul style="list-style-type: none"> • für 100 mm Innenlagergehäuse • L1: 159,5 mm, L2: 25,5 mm 	<ul style="list-style-type: none"> • for 100 mm bottom bracket housing • L1: 159.5 mm, L2: 25.5 mm



Tested by the manufacturer based on ISO 4210

KOMPAKT REPARATUR-INNENLAGER

- geeignet für **BSA-** und **italienisches** Tretlagergehäuse
- auch für **defekte Gewinde** geeignet
- passend für Shimano-Werkzeug
- mit verchromten Stahlschalen
- gedichtete **Industriekugellager**
- mit Achsschrauben
- im M-Wave Einzelkarton

›CAROUSEL BB REPAIR‹

359470 L1: 113 mm

359471 L1: 119 mm

359472 L1: 122,5 mm

359473 L1: 127 mm

359475 **›CAROUSEL BB REPAIR COTTER‹**

- L1: 136 mm
- Montage durch Kurbelkeile

REPAIR BOTTOM BRACKET

- suitable for **BSA** and **Italian** bottom bracket housing
- also suitable for **defective threads**
- suitable for Shimano tool
- with c. p. steel cups
- **sealed bearings**
- with axle bolts
- in M-Wave box

›CAROUSEL BB REPAIR‹

L1: 113 mm

L1: 119 mm

L1: 122.5 mm

L1: 127 mm

›CAROUSEL BB REPAIR COTTER‹

- L1: 136 mm
- mounting by crank cotter pins

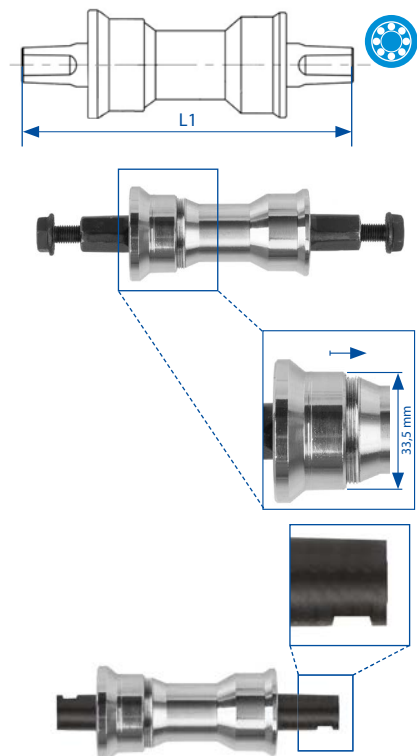

Bottom Brackets



GEWINDE-INNENLAGER

- **außenliegende, CNC-gefräste Aluminium-Lagerschalen**
- **2 Industriekugellager**
- mit Innenhülse für 68 mm Gehäusebreite, veränderbar durch **3 Adapterringe** (je 2,5 mm) bis zu 73 mm Gehäusebreite
- im M-Wave Einzelkarton

359430 **›CAROUSEL BB BSA EX JPN‹**

- **Shimano** kompatibel (kein original Shimano Ersatzteil)
- Innen-Ø 24 mm
- nur 90 g

359432 **›CAROUSEL BB BSA EX US‹**

- **Sram** kompatibel (kein original Sram Ersatzteil)
- Innen-Ø 24/22 mm
- nur 94 g

THREADED BOTTOM BRACKET

- **outer, CNC machined aluminium bearing cups**
- **2 sealed bearings**
- with inner casing for 68 mm b.b. housing width, adjustable with **3 adaptor rings** (each 2.5 mm) up to 73 mm b. b. housing width
- in M-Wave box

›CAROUSEL BB BSA EX JPN‹



- kompatibel with **Shimano** (no original Shimano spare part)
- inner Ø 24 mm
- only 90 g

›CAROUSEL BB BSA EX US‹

- kompatibel with **Sram** (no original Sram spare part)
- inner Ø 24/22 mm
- only 94 g

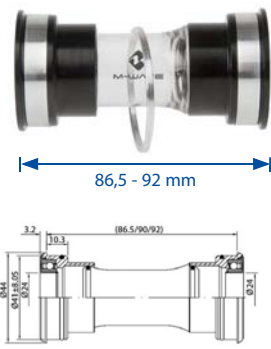
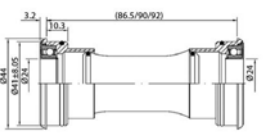

Tested by the manufacturer based on ISO 4210

ART.-NR. UVP	BESCHREIBUNG	DESCRIPTION	
359435 16,90 €  94 g 	PRESSFIT-INNENLAGER ›CAROUSEL BB PF EX‹ <ul style="list-style-type: none"> innenliegende, CNC-gefräste Aluminium-Lagerschalen zum Einpressen 2 Industriekugellager für Shimano Hollowtech II Tretlager (kein original Shimano Ersatzteil) Außen-Ø 41 mm/Innen-Ø 24 mm universell passend für Rennrad 86,5 mm und MTB 89,5/92 mm Breite mit wasserabweisender Kunststoff-Innenhülse inkl. Adapterring 2,0 mm nur 94 g im M-Wave Einzelkarton 	PRESS FIT BOTTOM BRACKET ›CAROUSEL BB PF EX‹ <ul style="list-style-type: none"> inner, CNC machined aluminium press fit bearing cups 2 sealed bearings for Shimano Hollowtech II cranksets (no original Shimano spare part) outer Ø 41 mm/inner Ø 24 mm universally useable for road 86.5 mm and MTB 89.5/92 mm width with water-repellent plastic inner casing incl. adaptor ring 2.0 mm only 94 g in M-Wave box 	  <div style="border: 1px solid black; padding: 2px; font-size: 8px;">Tested by the manufacturer based on ISO 4210</div>

360718 44,90 € mAD 65,90 €	SCHEIBENBREMSE HYDRAULISCH ›DBH-2‹ <ul style="list-style-type: none"> 2-Kolben-Bremse kompakte Bauweise für Mineralöl kaltgeschmiedetes Aluminium selbstjustierende Kolben Griffweite einstellbar mit kürzbarer Hydraulikleitung, Ø 5 mm mit Ersatzpin und Olive für Postmount System Montageverpackung 	DISC BRAKE HYDRAULIC ›DBH-2‹ <ul style="list-style-type: none"> Dual Piston compact construction for mineral oil cold forged aluminium self-adjusting pistons adjustable reach hydraulic hose can be shortened, Ø 5 mm with replacement pin and olive for Postmount system OEM 	
360719	für VR 900 mm Leitung	für front 900 mm tube	
360719	für HR 1.600 mm Leitung	für rear with 1,600 mm tube	

360691 149,00 €	WARTUNGSSET FÜR HYDRAULISCHE SCHEIBEN-BREMSEN ›BRAKE DOC BOX‹ <ul style="list-style-type: none"> passend für Shimano Deore XT 2005 - 2007 / 2009-2013 / 2016, Deore LX 2009 - 2013, Deore 2009 - 2013, XTR 2009 - 2013 / 2014 - 2015 / 2016 Hayes Stroker Trail, Stroker Carbon, Stroker Ace, Stroker Gram, El Camino Tektro Auriga Pro, Auriga SUB, Auriga Comp, Auriga Comp WS Magura Louise, Louise FR und Marta Avid Juicy 5/7 und Ultimate Bengal Helix 1.0/1.1, Helix 3 5 L, Helix 3 Carbon zwei Spritzen (30 ml und 10 ml) Schlauch-Adapter (4/5/6 mm) und Überwurfmutter Bremsflüssigkeit DOT 5.1 in M-Wave Aufbewahrungsbox 	BLEEDING KIT FOR DISC BRAKE HYDRAULIC ›BRAKE DOC BOX‹ <ul style="list-style-type: none"> suitable for Shimano Deore XT 2005 - 2007 / 2009 - 2013 / 2016, Deore LX 2009 - 2013, Deore 2009 - 2013, XTR 2009 - 2013 / 2014 - 2015 / 2016 Hayes Stroker Trail, Stroker Carbon, Stroker Ace, Stroker Gram, El Camino Tektro Auriga Pro, Auriga SUB, Auriga Comp, Auriga Comp WS Magura Louise, Louise FR and Marta Avid Juicy 5/7 and Ultimate Bengal Helix 1.0/1.1, Helix 3 5 L, Helix 3 Carbon two syringes (30 ml and 10 ml) adapters (4/5/6 mm) and swivel nuts brake liquid DOT 5.1 in M-Wave storage box 	
--------------------	--	--	---

Shimano® Deore XT 2005-2007 XTR 2014-2015 5x	Shimano® Deore XT 2016 XTR 2016 5x	Tektro® Auriga Pro Auriga SUB Auriga Comp Auriga Comp WS 8x	Magura® Louise Louise FR Marta 4x	Bengal® Helix 1.0/1.1 Helix 3 5 L Helix 3 carbon 3x	Hayes® Stroker Trail Stroker Carbon Stroker Ace Stroker Gram El Camino 4x	Avid® Juicy 5/7 Ultimate 4x	1x	1x
Shimano® Deore XT 2009-2013 Deore LX 2009-2013 XTR 2009-2013 8x	Überwurfmutter/ swivel nut für/for Shimano® für/for Avid® für/for Sram® 5x	Überwurfmutter/ swivel nut für/for Hayes® für/for Tektro® 5x	Schlauch-Adapter/ adapter for hose fitting 4mm 5mm 6mm 2x	Bremsflüssigkeit DOT 5.1/ brake fluid DOT 5.1 1x				2x

ART.-NR. UVP **BESCHREIBUNG**

DESCRIPTION

360692 U **WARTUNGSSET FÜR SCHEIBENBREMSEN**
25,90 € **BLEEDBOX**

- 2 x Spritze 25 ml
- 2 x M5 Adapter
- 2 x M6 Adapter
- 2 x O-Ring für DOT 4 Bremsflüssigkeit
- 2 x O-Ring für Mineralöl
- Leitungsschneider
- Entlüftungs-Distanzstück (für Promax-Scheibenbremsen)
- im M-Wave Einzelkarton

BLEEDING KIT FOR DISC BRAKES
BLEEDBOX

- 2 x syringe 25 ml
- 2 x M5 adapter
- 2 x M6 adapter
- 2 x O-ring for DOT 4 brake liquid
- 2 x O-ring for mineral oil
- tube cutter
- bleed block (for Promax disc brakes)
- in M-Wave box



BREMSFLÜSSIGKEIT

für hydraulische (Brems-)Systeme (z. B. für Scheibenbremsen von Fahrrädern)

BRAKE LIQUID

for hydraulic (brake) systems (e. g. for bicycle disc brakes)

Dot 5.1

365900 100 ml Flasche
6,90 €

365901 1 l Kanister
29,90 €

Dot 5.1

100 ml bottle

1 l canister



Mineralöl

365902 100 ml Flasche
5,90 €

365903 1 l Kanister
19,90 €

Mineral oil

100 ml bottle

1 l canister

SCHEIBENBREMSADAPTER

für die Verwendung von Postmount Bremskörpern mit größerer / kleinerer Brems Scheibe, sowie zur Montage an IS2000-Aufnahmen.

Passend für alle gängigen Postmount Bremskörper mit 6" Befestigungsschraubenabstand

8,90 € *Postmount-Adapter (Art. 360626-9) inkl. Befestigungsschrauben für Postmount.

ADAPTER FOR DISC BRAKE





for the use of postmount brake calipers with larger / smaller brake disc and for mounting to IS2000 base.

Suitable for all common postmount brake calipers with 6" mounting screw distance.

*Postmount adapters (art. 360626-9) incl. mounting screws for postmount.

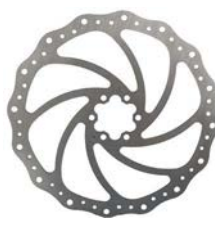

Montagesockel/ assembly base		Ø Bremsscheibe/disc		
		160mm	180mm	203mm
vorne, Gabel/ front, fork	IS 2000	360621	360623	360631
	Postmount		360627*	360629*
hinten, Rahmen/ rear, frame	IS 2000	360623	360625	
	Postmount		360627*	360629*

ART.-NR. UVP	BESCHREIBUNG	DESCRIPTION	
	BREMSSSCHEIBE	BRAKE DISC	
	<ul style="list-style-type: none"> • Edelstahl • inkl. Befestigungsschrauben 	<ul style="list-style-type: none"> • stainless steel • incl. fixing screws 	
	› BD-140 «, 140 mm	› BD-140 «, 140 mm	
360645	in M-Wave Verpackung	in M-Wave packaging	
11,90 €			
• 360643	Montageverpackung	OEM	
11,90 €			
	› BD-160 «, 160 mm	› BD-160 «, 160 mm	
360634	in M-Wave Verpackung	in M-Wave packaging	
11,90 €			
• 360600	Montageverpackung	OEM	
11,90 €			
	› BD-180 «, 180 mm	› BD-180 «, 180 mm	
360633	in M-Wave Verpackung	in M-Wave packaging	
12,90 €			
• 360606	Montageverpackung	OEM	
12,90 €			
	› BD-203 «, 203 mm	› BD-203 «, 203 mm	
360644	in M-Wave Verpackung	in M-Wave packaging	
12,90 €			
• 360641	Montageverpackung	OEM	
12,90 €			

1:1
FIGURE

BREMSELÄGE

- **organische Bremsbeläge**
- **Bremskraft gut dosierbar, Hitze isolierend** und leiser
- 1 Paar in M-Wave Blisterverpackung

Mit Hilfe der **1:1 Abbildungen** finden Sie schnell und einfach die richtigen Beläge.

BRAKE PADS

- **organic brake pads**
- **precisely controlled braking power, heat insulating** and quieter
- 1 pair in M-Wave blister packaging

With the help of **1:1 figures**, you find fast and easily the right pads.

SHIMANO

Tested by the manufacturer based on ISO 4210

360744
U für **Shimano** XTR: BR-M9000/20, BR-M987/5, XT: BR-M785, SLX: BR-M675/66, Deore: BR-M615, Alfine: BR-S700, Rennrad: BR-R785, BR-RS785, mit Nirosta Ersatz-Clip

for **Shimano** XTR: BR-M9000/20, BR-M987/5, XT: BR-M785, SLX: BR-M675/66, Deore: BR-M615, Alfine: BR-S700, racing: BR-R785, BR-RS785, with stainless steel replacement clip



360757
U 9,90 € für **Shimano** XTR: BR-M 965/6/75, XT: BR-M 765, SLX: BR-M605/85, LX: (BR-M 585/95, Deore: BR-M 535, Saint: BR-M 800, T665, Hone: BR-M 601, für **Tektro** TRP Dash mit Nirosta Ersatz-Clip

for **Shimano** XTR: BR-M 965/6/75, XT: BR-M 765, SLX: BR-M605/85, LX: (BR-M 585/95, Deore: BR-M 535, Saint: BR-M 800, T665, Hone: BR-M 601, for **Tektro** TRP Dash, with stainless steel replacement pin



Brakes & Accessories

ART.-NR. BESCHREIBUNG
UVP

DESCRIPTION

SHIMANO

360746 für **Shimano** BR-C501, BR-M575, BR-M525, BR-M495, BR-M486, BR-M485, BR-M475, BR-M465, BR-M447, BR-M446, BR-M445, BR-M416, BR-M416A, BR-M415, BR-M395, BR-M375, BR-T675, BR-T615, ..., für **Tektro** Auriga Pro, Auriga E-Comp, Auriga Comp, Aquila, Draco WS, Dorado, Orion, Gemini, Draco 2, TRP HY/RD, Spyre, Hywire, Parabox R, Parabox 2012 ..., für **Promax** DSK-909, für **Flat Mount** (Art. 360411), mit Nirosta Ersatz-Clip

for **Shimano** BR-C501, BR-M575, BR-M525, BR-M495, BR-M486, BR-M485, BR-M475, BR-M465, BR-M447, BR-M446, BR-M445, BR-M416, BR-M416A, BR-M415, BR-M395, BR-M375, BR-T675, BR-T615, ..., for **Tektro** Auriga Pro, Auriga E-Comp, Auriga Comp, Aquila, Draco WS, Dorado, Orion, Gemini, Draco 2, TRP HY/RD, Spyre, Hywire, Parabox R, Parabox 2012 ..., for **Promax** DSK-909, for **Flat Mount** (art. 360411), with stainless steel replacement pin



360745 für **Shimano** Saint BR-M810/20, ZEE BR-M640, mit Nirosta Ersatz-Clip

for **Shimano** Saint BR-M810/20, ZEE BR-M640, with stainless steel replacement pin



MAGURA

Tested by the manufacturer based on ISO 4210

360749 für **Magura** MT Serie MT2/4/6/8

for **Magura** MT Serie MT2/4/6/8



FORMULA

Tested by the manufacturer based on ISO 4210

360748 für **Formula** Mega, The One, R1, RX, T1, R1R, R0, C1, CR1, CR3, ..., mit Nirosta Ersatz-Clip

for **Formula** Mega, The One, R1, RX, T1, R1R, R0, C1, CR1, CR3, ..., with stainless steel replacement pin



ART.-NR. **BESCHREIBUNG**
UVP

DESCRIPTION

HAYES

360756
U für **Hayes** MX 2/3/Sole
für **Promax** DSK-810

for **Hayes** MX 2/3/Sole
for **Promax** DSK-810



360755
U für **Hayes** Stroker Ryde, Ryde HY Comp,
Radar
mit Nirosta Ersatz-Clip

for **Hayes** Stroker Ryde, Ryde HY Comp,
Radar
with stainless steel replacement pin



360754
U für **Hayes** HFX-9, MAG, MX-1,
mit Nirosta Ersatzfeder
9,90 €

for **Hayes** HFX-9, MAG, MX-1,
with stainless steel replacement pin



TEKTRO

360746
U für **Tektro** Auriga Pro, Auriga E-Comp,
Auriga Comp, Aquila, Draco WS, Dorado,
Orion, Gemini, Draco 2, TRP HY/RD, Spyre,
Hywire, Parabox R, Parabox 2012 ...,
für **Shimano** BR-C501, BR-M575, BR-
M525, BR-M495, BR-M486, BR-M485,
BR-M475, BR-M465, BR-M447, BR-M446,
BR-M445, BR-M416, BR-M416A, BR-M415,
BR-M395, BR-M375, BR-T675, BR-T615, ...,
für **Promax** DSK-909,
für **Flat Mount** (Art. 360411),
mit Nirosta Ersatz-Clip

for **Tektro** Auriga Pro, Auriga E-Comp,
Auriga Comp, Aquila, Draco WS, Dorado,
Orion, Gemini, Draco 2, TRP HY/RD, Spyre,
Hywire, Parabox R, Parabox 2012 ...,
für **Shimano** BR-C501, BR-M575, BR-
M525, BR-M495, BR-M486, BR-M485, BR-
M475, BR-M465, BR-M447, BR-M446, BR-
M445, BR-M416, BR-M416A, BR-M415,
BR-M395, BR-M375, BR-T675, BR-T615, ...,
für **Promax** DSK-909,
für **Flat Mount** (art. 360411),
with stainless steel replacement pin



ART.-NR. BESCHREIBUNG
UVP

DESCRIPTION

TEKTRO

360757
U für **Tektro** TRP Dash,
für **Shimano** XTR: BR-M 965/6/75, XT:
BR-M 765, SLX: BR-M605/85, LX: BR-M
585/95, Deore: BR-M 535, Saint: BR-M 800,
T665, Hone: BR-M 601,
mit Nirosta Ersatz-Clip

for **Tektro** TRP Dash,
for **Shimano** XTR: BR-M 965/6/75,
XT: BR-M 765, SLX: BR-M605/85,
LX: BR-M 585/95, Deore: BR-M 535,
Saint: BR-M 800, T665, Hone: BR-M
601,
with stainless steel replacement pin



360753
U für **Tektro** 10 mechanisch
9,90 €

for **Tektro** 10 mechanical



SRAM/AVID

Tested by the manufacturer
based on ISO 4210

360740
U für **Sram/Avid** Elixir XX, X0, DB,
mit Nirosta Ersatz-Clip

for **Sram/Avid** Elixir, XX, X0, DB,
with stainless steel replacement clip



360743
U für **Sram/Avid** Code,
mit Nirosta Ersatz-Clip
9,90 €

for **Sram/Avid** Code,
with stainless steel replacement clip



ART.-NR. BESCHREIBUNG
UVP

DESCRIPTION

SRAM/AVID

Tested by the manufacturer based on ISO 4210

360742 für **Sram/Avid** BB7, Juicy 5/7
U für **Promax** Q3, DSK-905
mit Nirosta Ersatz-Clip

for **Sram/Avid** BB7, Juicy 5/7
for **Promax** Q3, DSK-905
with stainless steel replacement clip



360741 für **Sram** X0 Trail/Guide,
U mit Nirosta Ersatz-Clip
9,90 €

for **Sram** X0 Trail/Guide,
with stainless steel replacement clip

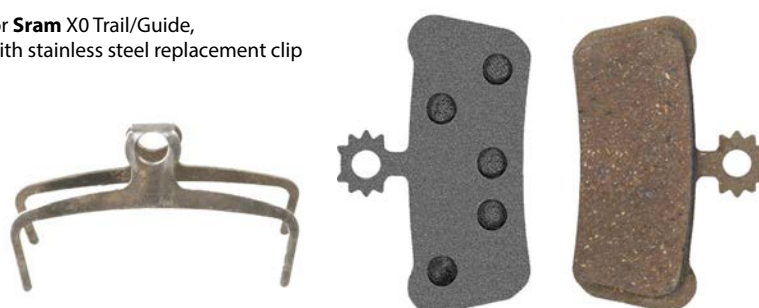

361742 **CARTRIDGE V-BREMSSCHUHE**
U **›BPR-VC-BASE-ALU‹**
8,90 €

- **Aluminium**-Bremsschuhe mit **austauschbaren** Bremsgummis
- Länge: 72 mm
- für V-Bremsen
- für trockene und nasse Verhältnisse
- für alle Stahl- und Aluminiumfelgen
- paarweise auf M-Wave Eurolochkarte

CARTRIDGE V-BRAKE SHOES
›BPR-VC-BASE-ALU‹

- **aluminium** brake shoes with **replaceable** brake rubbers
- length: 72 mm
- for V-brakes
- for dry and wet conditions
- for all steel- and aluminium rims
- 1 pair on M-Wave eurohole card



361771 **BREMSSCHUH-ERSATZBELAG**
U **›BPR-INSERT-VC‹**
2,90 €

- passend für Art. 361742, ...
- mit **Nirosta**-Stift
- paarweise auf M-Wave Eurolochkarte

BRAKE SHOE REPLACEMENT RUBBER **›BPR-INSERT-VC‹**

- suitable for art. 361742, ...
- with **stainless** pin
- 1 pair on M-Wave eurohole card



Tested by the manufacturer based on ISO 4210

361021 **V-BREMSSCHUHE**
U **›BPR-VC-DUAL‹**
4,90 €

- mit **2-farbigen** Bremsgummis:
2 Farben = 2 Funktionen durch 2 Profile:
schwarz = starke Bremswirkung
rot = Wasserverdrängung
- Länge: 72 mm
- für V-Bremsen
- für trockene und nasse Verhältnisse
- für alle Stahl- und Aluminiumfelgen
- Bolzen mit Gewinde und Befestigungsmaterial
- paarweise auf M-Wave Eurolochkarte

V-BRAKE SHOES
›BPR-VC-DUAL‹

- with **2 coloured** brake shoes
- **2 colours = 2 functions through 2 profiles:**
black = extra grip
red = water displacement
- length: 72 mm
- for V-brakes
- for dry and wet conditions
- for all steel- and aluminium rims
- bolt with thread and mounting material
- 1 pair on M-Wave eurohole card



ART.-NR. UVP **BESCHREIBUNG** **DESCRIPTION**

361020 **V-BREMSSCHUHE**
U
2,90 €
›BPR-VC-BASE‹

- Länge: 72 mm
- für V-Bremsen
- für trockene und nasse Verhältnisse
- für alle Stahl- und Aluminiumfelgen
- Bolzen mit Gewinde und Befestigungsmaterial
- paarweise auf M-Wave Eurolochkarte

V-BRAKE SHOES
›BPR-VC-BASE‹

- length: 72 mm
- for V-brakes
- for dry and wet conditions
- for all steel- and aluminium rims
- bolt with thread and mounting material
- 1 pair on M-Wave eurohole card



Tested by the manufacturer based on ISO 4210

361024 25 Paar in Werkstatt-Verpackung
U
59,90 €

25 pair in workshop-packaging



361622 **V-BREMSSCHUHE**
4,90 €
›BPR-VC-BASE-TWIN‹

- Länge: 70 mm
- symmetrisch
- 2 Paar auf M-Wave Eurolochkarte

V-BRAKE SHOES
›BPR-VC-BASE-TWIN‹

- length: 70 mm
- symmetric
- 2 pairs on M-Wave eurohole card



V-BREMSSCHUHE
›BPR-VC-NT‹

- Länge: 72 mm
- für trockene und nasse Verhältnisse
- für alle Stahl- und Aluminiumfelgen
- Bolzen ohne Gewinde

V BRAKE SHOES
›BPR-VC-NT‹

- length: 72 mm
- for dry and wet conditions
- for all steel- and aluminium rims
- bolt without thread

361022 paarweise auf M-Wave Eurolochkarte
U

1 pair on M-Wave eurohole card

361023 paarweise im Polybeutel
2,90 €

1 pair in PE bag



Tested by the manufacturer based on ISO 4210

361792 **BREMSSCHUHE FÜR**
U
5,90 €
HYDRAULISCHE FELGENBREMSEN
›BPR-HY‹



- für **Aluminium-** und **Stahlfelgen**
- z. B. für **Magura** HS11, HS22, HS33R, HS33R Trial, HS33 R FIRMtech (kein original Magura Ersatzteil)
- 50 mm
- paarweise im **Polybeutel**

BRAKE SHOES FOR
HYDRAULIC RIM BRAKES
›BPR-HY‹

- for **aluminium** and **steel** rims
- e. g. **Magura** HS11, HS22, HS33R, HS33R Trial, HS33 R FIRMtech (no original Magura spare part)
- 50 mm
- 1 pair in **PE bag**



Tested by the manufacturer based on ISO 4210

ART.-NR. UVP	BESCHREIBUNG	DESCRIPTION	
361770 U 8,90 €	CARTRIDGE RENNRAD-BREMSSCHUHE ›BPR-RR-BASE-ALU‹ <ul style="list-style-type: none"> • Aluminium-Bremsschuhe mit austauschbaren Bremsgummis • Länge: 55 mm • auch für Rennradbremsen von Shimano (Dura Ace, Ultegra, ...; kein original Shimano-Ersatzteil) • für trockene und nasse Verhältnisse • für alle Stahl- und Aluminiumfelgen • paarweise auf M-Wave Eurolochkarte 	CARTRIDGE ROAD RACING BRAKE SHOES ›BPR-RR-BASE-ALU‹ <ul style="list-style-type: none"> • aluminium brake shoes with replaceable brake rubbers • length: 55 mm • also for racing brakes of Shimano (Dura Ace, Ultegra, ...; no original Shimano spare part) • for dry and wet conditions • for all steel- and aluminium rims • 1 pair on M-Wave eurohole card 	<div data-bbox="1308 224 1500 268" style="border: 1px solid black; padding: 2px; font-size: 8px;">Tested by the manufacturer based on ISO 4210</div> 
361772 U 2,90 €	BREMSSCHUH-ERSATZBELAG ›BPR-INSERT-RR‹ <ul style="list-style-type: none"> • passend für Art. 361770 und Shimano Bremsen (Dura Ace, Ultegra, ...; kein original Shimano Ersatzteil) • paarweise auf M-Wave Eurolochkarte 	BRAKE SHOE REPLACEMENT RUBBER ›BPR-INSERT-RR‹ <ul style="list-style-type: none"> • suitable for art. 361770 and Shimano brakes (Dura Ace, Ultegra, ...; no original Shimano spare part) • 1 pair on M-Wave eurohole card 	
	BREMSSCHUHE ›BPR-T‹ <ul style="list-style-type: none"> • Länge: 55 mm • für trockene und nasse Verhältnisse • für alle Stahl- und Aluminiumfelgen • Bolzen mit Gewinde und Befestigungsmaterial 	BRAKE SHOES ›BPR-T‹ <ul style="list-style-type: none"> • length: 55 mm • for dry and wet conditions • for all steel- and aluminium rims • bolt with thread and mounting material 	<div data-bbox="1308 940 1500 985" style="border: 1px solid black; padding: 2px; font-size: 8px;">Tested by the manufacturer based on ISO 4210</div> 
361030 U 2,90 €	›BPR-T‹ paarweise auf M-Wave Eurolochkarte	›BPR-T‹ 1 pair on M-Wave eurohole card	
361754 1,50 €	100 St. im Polybeutel	100 pcs in PE bag	



ART.-NR. UVP	BESCHREIBUNG	DESCRIPTION
-----------------	--------------	-------------

370295 **KABELFÜHRUNG**
U
7,90 €

- für 4-5 mm Außenhüllen
- kann **universell durch Kabelbinder** am Rahmen befestigt oder **aufgeklebt** werden
- 3 Stk. im Polybeutel mit M-Wave Eurolochheader

CABLE GUIDE

- for 4-5 mm outer housings
- can **universally** be mounted to frames **with cable ties** or **sticker**
- 3 pcs. in PE bag with M-Wave eurohole header

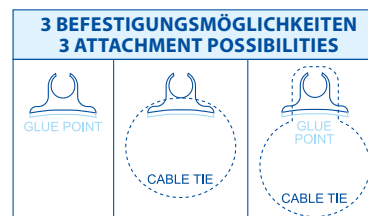

CNC **AUSSENHÜLLENENDHÜLSEN**

- **CNC-gefräst**
- 12 mm lang
- 200 Stk. in M-Wave Dose

OUTER HOUSING END CAPS

- **CNC machined**
- length 12 mm
- 200 pcs. in M-Wave can

- Innen-Ø **4,1 mm**
- für Schalt-/(Brems-)zughüllen

- inner-Ø **4.1 mm**
- for derailleur/(brake) cable outer housings



370210 rot eloxiert

red anodised

370231 blau eloxiert

blue anodised

370232 grün eloxiert

green anodised



- Innen-Ø **5,1 mm**
- für Brems-/(Schalt-)zughüllen

- inner-Ø **5.1 mm**
- for brake/(derailleur) cable outer housings



370211 rot eloxiert

red anodised

370236 blau eloxiert

blue anodised

370237 grün eloxiert

green anodised



370238 gold-orange eloxiert

gold-orange anodised

390,00 €/1.000

ENDHÜLSE FÜR INNENZÜGE

- **Aluminium**
- Innen-Ø ca. 1,7 x 10 mm Länge
- 500 Stk. in M-Wave Dose

END CAP FOR INNER CABLES

- **aluminium**
- inner-Ø approx. 1.7 mm x 10 mm length
- 500 pcs. in M-Wave can



370218 schwarz eloxiert
U

black anodised

370217 rot eloxiert

red anodised

370226 blau eloxiert

blue anodised

370227 grün eloxiert

green anodised

370228 gold-orange eloxiert

gold-orange anodised



99,90 €/1.000

ART.-NR. UVP **BESCHREIBUNG**

DESCRIPTION

SCHUTZBLECH-SET

- für Vorder- und Hinterrad
- Kunststoff
- **Länge werkzeuglos verstellbar**
- Steckbefestigung
- auf M-Wave Eurolochkarte

MUDGUARD SET

- front and rear
- plastic
- **length adjustable without tools**
- clip-on system
- on M-Wave eurohole card

385138 ›MUD MAX F+R ADJ S‹

- 16,90 €
- universell passend für **20" - 24"**
 - max. Reifenbreite: 55 mm

›MUD MAX F+R ADJ S‹

- universal type for **20" - 24"**
- max. tire width: 55 mm



385137 ›MUD MAX F+R ADJ L‹

- 27,90 €
- universell passend für **26" - 29"**
 - mit **Sicherheitsstrebenbefestigung**
 - max. Reifenbreite: 62 mm

›MUD MAX F+R ADJ L‹

- universal type for **26" - 29"**
- with **safety stays**
- max. tire width: 62 mm



SCHUTZBLECH-SET 26"

- für Vorder- und Hinterrad
- **26"**, MTB
- Modell ›**ECO**‹
- Kunststoff
- passend für V- und Cantilever-Bremsen
- Steckbefestigung

MUDGUARD SET 26"

- front and rear
- **26"**, MTB
- model ›**ECO**‹
- plastic
- for V- and cantilever brakes
- clip-on system

386047 in M-Wave Verpackung (Art. 084090)

in M-Wave packaging (art. 084090)

386048
U
6,90 €

Set im Polybeutel

set in PE bag



SCHUTZBLECH-SET

›MUD MAX UNIVERSAL‹ 26" - 29"

- für Vorder- und Hinterrad
- **universell** passend für **26" - 29"**
- Kunststoff
- **seitliche Versteifungen**
- variable Steckbefestigung
- passend für V- und Cantilever-Bremsen
- mit **langem Spritzschutz**

MUDGUARD SET

›MUD MAX UNIVERSAL‹ 26" - 29"

- front and rear
- **universal** type for **26" - 29"**
- plastic
- **reinforced sides**
- variable clip-on system
- for V- and cantilever brakes
- with **long end**

386080 in M-Wave Verpackung (Art. 084090)

in M-Wave packaging (art. 084090)

386085
U
8,90 €

Set im Polybeutel

set in PE bag



386086 wie Art. 386085, aber
9,90 €

- mit **Klettband** für zusätzliche Sicherheitsbefestigung am Sitzrohr
- Set auf M-Wave **Eurolochkarte**

like art. 386085, but

- with **hook and loop fastener** for additional security fixing at the seat tube
- set on M-Wave **eurohole card**

HOOK AND LOOP FASTENER



ART.-NR. UVP **BESCHREIBUNG**

DESCRIPTION

- 386031** **SCHUTZBLECH-SET 28"**
 ›MUD MAX II F+R‹
 24,90 €
- für Vorder- und Hinterrad
 - **28"**
 - Breite: 45 mm
 - aus **hochwertigem, flexiblem Kunststoff: ohne Beschädigung knick- und drehbar**
 - **Sicherheitsstrebenbefestigung aus Nirosta**
 - Befestigungsmaterialien aus **Nirosta**
 - langer **Spritzschutz aus Gummi hinten**
 - auf M-Wave Eurolochkarte

- MUDGUARD SET 28"**
 ›MUD MAX II F+R‹
- front and rear
 - **28"**
 - width: 45 mm
 - **high quality flexible plastic: turnable and bendable without damage**
 - **stainless steel safety stays**
 - mounting materials made of **stainless steel**
 - long **rubber end at the rear**
 - on M-Wave eurohole card



Ab einer Mindestmenge von 500 Paar sind diese Schutzbleche ohne Aufpreis auch in blau, rot, gelb, schwarz, grau oder weiß erhältlich! Spritzschutz in 12 verschiedenen Farben erhältlich.

From a minimum of 500 pairs, these mudguards are also available in blue, red, yellow, black, grey or white without upcharge! Rubber end available in 12 different colours.



- 386096** **SCHUTZBLECH-SET 26" - 29"**
 ›MUD MAX III‹
 13,90 €
- für Vorder- und Hinterrad
 - **universell** passend für **26" - 29"**
 - Kunststoff
 - Steckbefestigung und **Sicherheitsstrebenbefestigung**
 - mit **langem Spritzschutz**
 - Set im Polybeutel

- MUDGUARD SET 26" - 29"**
 ›MUD MAX III‹
- front and rear
 - **universal type for 26" - 29"**
 - plastic
 - clip-on system and **safety stays**
 - with **long end**
 - set in PE bag



- 385070** **STECKSCHUTZBLECH**
 ›MUD MAX QR.F II‹
 U
 24,90 €
- für Vorderrad
 - universell passend für **26" - 29"**
 - auch für **Federgabeln** geeignet
 - mit **Konusbefestigung** im Gabelschaft (mit Adapter für Ø 18,5 – 34,5 mm)
 - auf M-Wave Eurolochkarte

- CLIP ON MUDGUARD**
 ›MUD MAX QR.F II‹
- front
 - universal type for **26" - 29"**
 - to be used for **suspension forks** as well
 - with **coneclamp** in fork innertube (with adapter for Ø 18,5 – 34,5 mm)
 - on M-Wave eurohole card



- 385071** **STECKSCHUTZBLECH**
 ›MUD MAX QR.R II‹
 U
 34,90 €
- für Hinterrad
 - universell passend für **26" - 29"**
 - mit universellem **Clip-on-Halter** passend für Sattelstütze und Rahmenrohr
 - stabile **3-Punkt Halterung** reduziert Flattern
 - **Winkel und Höhe verstellbar**
 - auf M-Wave Eurolochkarte

- CLIP ON MUDGUARD**
 ›MUD MAX QR.R II‹
- rear
 - universal type for **26" - 29"**
 - with universal **clip-on bracket** for seat post and frame tube
 - stable **3 point fixation** reduces fluttering
 - **angle and height adjustable**
 - on M-Wave eurohole card



ART.-NR. UVP **BESCHREIBUNG**

DESCRIPTION

385130 STECK-SCHUTZBLECH

16,90 €

- ›MUD MAX QR.F III‹
- für Vorderrad
 - universell passend für **26" - 29"**
 - auch für **Federgabeln** geeignet
 - mit **Konusbefestigung** im Gabelschaft (Adapter für Ø 16 - 35 mm)
 - lässt sich in 2 Teilen von der Halterung abnehmen
 - max. Reifenbreite: 85 mm
 - auf M-Wave Eurolochkarte

CLIP-ON MUDGUARD

- ›MUD MAX QR.F III‹
- front
 - universal type for **26" - 29"**
 - to be used for **suspension forks** as well
 - with **coneclamp** in fork innertube (with adapter for Ø 16 - 35 mm)
 - can be removed from the bracket in 2 parts
 - max. tire width: 85 mm
 - on M-Wave eurohole card



STECK-SCHUTZBLECH

- für Hinterrad
- mit universellem Halter passend für **Sattelstützen** mit Ø 24 - 36 mm
- **Winkel verstellbar**
- auf M-Wave Eurolochkarte

CLIP-ON MUDGUARD

- rear
- with **universal bracket for seat posts** with Ø 24 - 36 mm
- **angle adjustable**
- on M-Wave eurohole card



385133 ›MUD MAX QR.R III‹

14,90 €

- universell passend für **26" - 29"**
- max. Reifenbreite: 85 mm

›MUD MAX QR.R III‹

- universal type for **26" - 29"**
- max. tire width: 85 mm



385135 ›MUD MAX QR.R SLIM‹

12,90 €

- **28"**
- für **Rennrad-, Gravel-, und Trekkingräder**
- max. Reifenbreite: 42 mm

›MUD MAX QR.R SLIM‹

- **28"**
- for **road, gravel and trekking bikes**
- max. tire width: 42 mm



385088 STECK-SCHUTZBLECH

24,90 €

- ›MUD MAX F III‹
- für Vorderrad
 - universell passend für **26"-29"**
 - auch für **Federgabeln** geeignet
 - mit **Clip-on-Halter** und **Konusbefestigung** im Gabelschaft (mit Adaptern für 18 - 36 mm)
 - auf M-Wave Eurolochkarte

CLIP-ON MUDGUARD

- ›MUD MAX F III‹
- front
 - universal type for **26"-29"**
 - to be used for **suspension forks** as well
 - with **clip-on bracket** and **coneclamp** in fork innertubes (with adapters for Ø 18 - 36 mm)
 - on M-Wave eurohole card



385089 STECK-SCHUTZBLECH

24,90 €

- ›MUD MAX R III‹
- für Hinterrad
 - universell passend für **26"-29"**
 - mit universellem **Clip-on-Halter** passend für Sattelstützen
 - Winkel verstellbar
 - auf M-Wave Eurolochkarte

CLIP-ON MUDGUARD

- ›MUD MAX R III‹
- rear
 - universal type for **26"-29"**
 - with universal **clip-on bracket** for seat posts
 - angle adjustable
 - on M-Wave eurohole card



ART.-NR. UVP **BESCHREIBUNG**

DESCRIPTION

385054 U **SCHUTZBLECH**
›MUD MAX QR.F‹
16,90 €

- für Vorderrad
- universell passend für **26" - 29"**
- auch für **Federgabeln** geeignet
- mit **Clip-on-Halter** und **Konusbefestigung** im Gabelschaft (mit Adaptern für Ø 18,5 - 34,5 mm)
- auf M-Wave Eurolochkarte

MUDGUARD
›MUD MAX QR.F‹

- front
- universal type for **26" - 29"**
- to be used for **suspension forks** as well
- with **clip-on bracket** and **coneclamp** in fork innertube (with adapters for Ø 18.5 - 34.5 mm)
- on M-Wave eurohole card



385055 U **SCHUTZBLECH**
›MUD MAX QR.R‹
16,90 €

- für Hinterrad
- universell passend für **26" - 29"**
- Kunststoff
- mit universellem **Clip-on-Halter** passend für Sattelstütze und Rahmenrohr
- **Winkel** und **Höhe verstellbar**
- auf M-Wave Eurolochkarte

MUDGUARD
›MUD MAX QR.R‹

- rear
- universal type for **26" - 29"**
- plastic
- with universal **clip-on bracket** for seat post and frame tube
- **angle** and **height adjustable**
- on M-Wave eurohole card



386030 **SCHUTZBLECH** ›MUD MAX II R‹

- 8,90 €
- für Hinterrad
 - universell passend für **20" - 29"**
 - aus **hochwertigem, flexiblem Kunststoff: ohne Beschädigung knick- und drehbar**
 - inkl. Halter für Sattelstütze, passend für Ø 25,0 - 31,8 mm
 - **Winkel** und **Höhe** durch 2 Gelenke **zweifach verstellbar**
 - auf M-Wave Eurolochkarte

MUDGUARD ›MUD MAX II R‹

- for rear
- universal type for **20" - 29"**
- **high quality flexible plastic: turnable and bendable without damage**
- incl. bracket for seat post, suitable for Ø 25.0 - 31.8 mm
- **angle** and **height doubly adjustable** by two hinges
- on M-Wave eurohole card



386205 U **SCHUTZBLECH**
›MUD MAX FAT F‹
24,90 €

**PLUS/
FAT**

- für Vorderrad
- universell passend für **24" - 29"**
- Breite **115 mm**
- Kunststoff
- mit **Konusbefestigung** im Gabelschaft **1" - 1 1/8"**
- **Winkel verstellbar**
- auf M-Wave Eurolochkarte

MUDGUARD
›MUD MAX FAT F‹

- front
- universal type for **24" - 29"**
- width **115 mm**
- plastic
- with **coneclamp** in fork innertube **1" - 1 1/8"**
- **angle adjustable**
- on M-Wave eurohole card



386206 U **SCHUTZBLECH**
›MUD MAX FAT R‹
29,90 €









- für Hinterrad
- universell passend für **24" - 29"**
- Breite **115 mm**
- Kunststoff
- **werkzeuglose** Montage
- mit universellem Halter passend für Sattelstütze und Sattelrohr, für Ø 27,2 - 33,5 mm
- **Winkel** und **Höhe verstellbar**
- auf M-Wave Eurolochkarte

MUDGUARD
›MUD MAX FAT R‹



- rear
- universal type for **24" - 29"**
- width **115 mm**
- plastic
- **toolless** mounting
- with universal bracket suitable for seat post and frame tube, for Ø 27.2 - 33.5 mm
- **angle** and **height adjustable**
- on M-Wave eurohole card



ART.-NR. UVP	BESCHREIBUNG	DESCRIPTION	
	<p>SCHUTZBLECH-SET ›MUD MAX KIDS F+R‹</p> <ul style="list-style-type: none"> • für Vorder- und Hinterrad • aus hochwertigem, flexiblem Kunststoff: ohne Beschädigung knick- und drehbar • seitliche Versteifungen • passend für V- und Cantilever-Bremsen • variable Steckbefestigung • langer Spritzschutz aus Gummi hinten • auf M-Wave Eurolochkarte 	<p>MUDGUARD SET ›MUD MAX KIDS F+R‹</p> <ul style="list-style-type: none"> • for front and rear • high quality flexible plastic: turnable and bendable without damage • reinforced sides • suitable for V- and cantilever brakes • variable clip-on-system • long rubber end at the rear • on M-Wave eurohole card 	  
386033 U	für 16" - 20" Kinderräder	for 16" - 20" children bikes	
386032 U 12,90 €	für 12" - 18" Kinderräder	for 12" - 18" children bikes	
	<p>Ab einer Mindestmenge von 500 Paar sind diese Schutzbleche ohne Aufpreis auch in blau, rot, gelb, schwarz, grau oder weiß erhältlich! Spritzschutz in 12 verschiedenen Farben erhältlich.</p>	<p>From a minimum of 500 pairs, these mudguards are also available in blue, red, yellow, black, grey or white without upcharge! Rubber end available in 12 different colours.</p>	

386011 U 6,90 €	<p>DIRT BOARD ›MUD MAX DT‹</p> <ul style="list-style-type: none"> • universelle Befestigung am Unterrohr • asymmetrisches Design für optimalen Schutz bei unterschiedlichen Fahrpositionen (180° drehbar) • werkzeuglose Montage mit 2 Gummibändern • aus schlagfestem Kunststoff • mit Non-Slip-Einlagen • ca. 32 x 9/13 cm • auf M-Wave Eurolochkarte 	<p>DIRT BOARD ›MUD MAX DT‹</p> <ul style="list-style-type: none"> • universal mounting on the down tube • asymmetric design to protect optimally in various drive positions (180° turnable) • toolless mounting by two rubber strips • impact resistant plastic • with non-slip inlays • approx. 32 x 9/13 cm • on M-Wave eurohole card 	
			
			
			

385136 7,90 €	<p>DIRT BOARD ›MUD MAX DT.S‹</p> <ul style="list-style-type: none"> • schmale Ausführung für Renntagel- und Trekkingräder • universelle Befestigung am Unterrohr • werkzeuglose Montage mit 2 Gummibändern • max. Reifenbreite: 60 mm • auf M-Wave Eurolochkarte 	<p>DIRT BOARD ›MUD MAX DT.S‹</p> <ul style="list-style-type: none"> • narrow version for road, gravel and trekking bikes • universal mounting on the down tube • toolless mounting by 2 rubber strips • max. tire width: 60 mm • on M-Wave eurohole card 	 
			

385131 9,90 €	<p>UNIVERSAL SCHUTZBLECH ›MUD MAX FLEX F‹</p> <ul style="list-style-type: none"> • für Vorderrad • universell passend für 26" - 29" • strapazierfähiger Kunststoff • werkzeuglose Befestigung an der Gabel • max. Reifenbreite: 82 mm • inkl. 6 Kabelbinder • auf M-Wave Eurolochkarte 	<p>UNIVERSAL MUDGUARD ›MUD MAX FLEX F‹</p> <ul style="list-style-type: none"> • front • universal type for 26" - 29" • hard-wearing plastic • toolless attachment to the fork • max. tire width: 82 mm • incl. 6 cable ties • on M-Wave eurohole card 	 
			

ART.-NR. BESCHREIBUNG
UVP

DESCRIPTION

385052 UNIVERSAL SCHUTZBLECH
›MUD MAX FLEX F/R‹
U
6,90 €



- für **Vorder-** oder **Hinterrad**
- **strapazierfähiger** und **flexibler Kunststoff**
- zur Befestigung an **Gabel** und **Sitzrohrstreben**
- **werkzeuglose** Montage
- universell passend für fast alle Fahrräder
- inkl. 4 Kabelbinder
- auf M-Wave Eurolochkarte

UNIVERSAL MUDGUARD
›MUD MAX FLEX F/R‹

- for **front** or **rear**
- **hard-wearing** and **flexible plastic**
- for attachment to **fork** and **seat stays**
- **toolless** mounting
- universally suitable for almost all bikes
- incl. 4 cable ties
- on M-Wave eurohole card



385132 UNIVERSAL SCHUTZBLECH
›MUD MAX FLEX F/R +‹
7,90 €



2IN1

- für **Vorder-** oder **Hinterrad**
- universell passend für **26" - 29"**
- **strapazierfähiger** und **flexibler Kunststoff**
- **werkzeuglose Befestigung** an der **Gabel** oder durch Zuschneiden einfache Anbringung am **Sattelgestell**
- Länge: 325 mm
- inkl. 4 Kabelbinder
- auf M-Wave Eurolochkarte

UNIVERSAL MUDGUARD
›MUD MAX FLEX F/R +‹

- **front** or **rear**
- universal type for **26" - 29"**
- **hard-wearing** and **flexible plastic**
- **toolless attachment** to the **fork** or easy attachment to the **saddle rails** by cutting to size
- length: 325 mm
- incl. 4 cable ties
- on M-Wave eurohole card



385051 UNIVERSAL SCHUTZBLECH
›MUD MAX FLEX R‹
U
6,90 €



- für **Hinterrad**
- **strapazierfähiger** und **flexibler Kunststoff**
- besserer Schutz durch **Verlängerung**
- zur Schnellbefestigung am Sattelgestell
- **werkzeuglose** Montage
- universell passend für fast alle Fahrräder
- nur **18 g**
- auf M-Wave Eurolochkarte

UNIVERSAL MUDGUARD
›MUD MAX FLEX R‹

- for **rear**
- **hard-wearing** and **flexible plastic**
- better protection through **extension**
- for fast attachment to saddle rails
- **toolless** mounting
- universally suitable for almost all bikes
- only **18 g**
- on M-Wave eurohole card



**SCHUTZBLECH FÜR SATTEL-
GESTELL**

- zur **werkzeuglosen** Schnellbefestigung am Sattelgestell
- universell passend für **26" - 29"**
- **Winkel verstellbar**
- auf M-Wave Eurolochkarte

**MUDGUARD FOR SADDLE
RAILS**

- for fast **toolless** attachment to saddle rails
- universal type for **26" - 29"**
- **angle adjustable**
- on M-Wave eurohole card



385134 ›MUD MAX SEAT LONG‹

- nur 74 g
- max. Reifenbreite: 75 mm

›MUD MAX SEAT LONG‹

- only 74 g
- max. tire width: 75 mm



385139 ›MUD MAX SEAT SHORT‹

- nur 105 g
- max. Reifenbreite: 125 mm

›MUD MAX SEAT SHORT‹

- only 105 g
- max. tire width: 125 mm



ART.-NR. UVP **BESCHREIBUNG**

DESCRIPTION



SCHUTZBLECH-SET ›MUD MAX RACE QR‹ 28"

- für Vorder- und Hinterrad
- **flexibles** Kunststoffschutzblech
- mit **Schnellverschlüssen** (Art. 385098) zur **werkzeuglosen** Montage an den Sitzrohrstreben/Gabelscheidern
- mit **längenverstellbarer** Strebenbefestigung aus **Nirosta**
- auf M-Wave Eurolochkarte

MUDGUARD SET ›MUD MAX RACE QR‹ 28"

- front and rear
- **flexible** plastic mudguard
- with **quick releases** (art. 385098) for **toolless** mounting at the seat stays/fork legs
- with **length adjustable stainless steel** safety stays
- on M-Wave eurohole card



385061 Breite **33 mm**
mit **abnehmbarem Verlängerungsstück**

width **33 mm**
with **removable extension piece**

385081 U
Breite **42 mm**
49,90 €

width **42 mm**





SCHUTZBLECH-SET

- für Vorder- und Hinterrad
- **flexibles** Kunststoffschutzblech
- integrierter, **2-facher**, elektrischer **Kontaktstreifen**
- **längenverstellbare Sicherheits-**Strebenbefestigung aus **Nirosta** mit **2 cm Verstellbereich**
- **Sicherheitsenden**
- inklusive 2 Anschlusslichtkabeln
- in M-Wave Verpackung (Art. 084090)

MUDGUARD SET

- front and rear
- **flexible** plastic mudguard
- integrated, **double**, electrical **contact**
- **length adjustable stainless steel** safety stays with **2 cm variability**
- **safety ends**
- incl. 2 dynamo cables
- in M-Wave packaging (art. 084090)

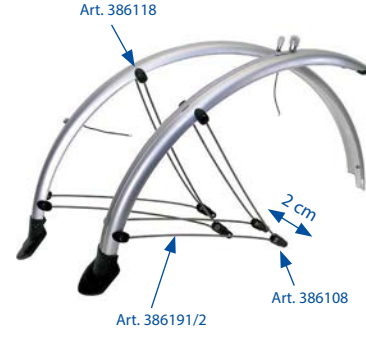

 M-Wave Verpackung / M-Wave packaging	 schwarz / black		 silber / silver	
	in M-Wave Verpackung in M-Wave packaging	Set im Polybeutel set in PE bag	in M-Wave Verpackung in M-Wave packaging	Set im Polybeutel set in PE bag
20" Breite/width 56 mm	386170 20 set	386110 40 set		
24" Breite/width 56 mm	386171 20 set	386117 30 set		
26" Breite/width 60 mm	386172 20 set	386104 U 20 set	386173 20 set	386107 20 set
27,5" Breite/width 60 mm	386178 20 set	386180 20 set		
28" Breite/width 45 mm	386174 20 set	386105 U 30 set	386175 20 set	386106 30 set
28"/29" Breite/width 56 mm	386176 20 set	386115 20 set	386177 20 set	386116 20 set
29" Breite/width 60 mm	386179 20 set	386181 20 set		
UVP	34,90 €	34,90 €	34,90 €	34,90 €

389992 AUFPREIS SCHUTZBLECHE

- für farbigen Mittelstreifen
- erhältlich für Art. 386104-7, 386110, 386115-7, ...

UPCHARGE MUDGUARDS

- for coloured middle strip
- available for art. 386104-7, 386110, 386115-7, ...



ART.-NR. UVP **BESCHREIBUNG**

DESCRIPTION

FELGE ›R4022‹

- Aluminium Hohlkammerfelge
- **28" / 622 mm**
- Felgenhöhe 40 mm
- 32 Loch
- mit Verschleißanzeige
- **CNC aufgeraute Bremsflanken (GBS)**
- AV/DV/FV
- ERD: 559 mm

- **381040** schwarz
- **381041** silber
- **381042** weiß
- 32,90 €
- **381045** grün
- **381048** pink
- 29,90 €

RIM ›R4022‹

- aluminium hollow section rim
- **28" / 622 mm**
- rim height 40 mm
- 32 hole
- with wearout indicator
- **CNC grooved braking sides (GBS)**
- AV/DV/FV
- ERD: 559 mm

- black
- silver
- white
- green
- pink

Tested by the manufacturer based on ISO 4210



380467 ENDURO DISC FELGE ›4.30‹

52,90 €



PLUS

560 g

- **28"/29"** (Ø 622 mm)
- aus extrem steifem **6005 Aluminium**
- **Nirosta-Ösen**
- **30 mm** Innenbreite
- **tubeless** ready
- **Inner-Hook-Technologie: speziell konstruiertes Felgenprofil** hält den Reifen auch bei Druckverlust länger auf der Felge
- nur 560 g
- 32 Loch
- ERD: 598,3 mm
- schwarz eloxiert
- für FV
- max. Belastbarkeit **140 kg**

ENDURO DISC RIM ›4.30‹

- **28"/29"** (Ø 622 mm)
- made of extremely stiff **6005 aluminium**
- **stainless steel eyelets**
- **30 mm** inner width
- **tubeless** ready
- **Inner-Hook-Technology: a specially constructed rim profile** keeps the tire longer on the rim also in case of pressure loss
- only 560 g
- 32 hole
- ERD: 598.3 mm
- black anodised
- for FV
- max. load capacity **140 kg**

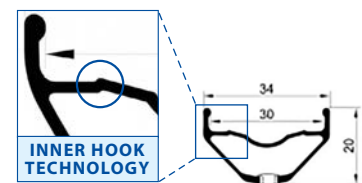

380466 DISC FELGE ›2.19‹

29,90 €



- **28"/29"**
- aus extrem steifem **6005 Aluminium**
- **Nirosta-Ösen**
- 32 Loch
- 19 mm Innenbreite
- für AV/FV/DV
- schwarz eloxiert
- ERD: 597,7 mm

DISC RIM ›2.19‹

- **28"/29"**
- made of extremely stiff **6005 aluminium**
- **stainless steel eyelets**
- 32 hole
- 19 mm inner width
- for AV/FV/DV
- black anodised
- ERD: 597.7 mm

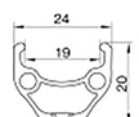

ART.-NR. BESCHREIBUNG
UVP

DESCRIPTION

AHEAD INTEGRIERT

AHEAD INTEGRATED

• **390801** INTEGRIERTER CARTRIDGE-
STEUERSATZ, 1 1/8" → 1,5"
›IS42/52 C‹

19,90 €



- **Aluminium**
- 45° x 45°
- mit **Industriekugellager**
- inkl. Krallen
- schwarz
- **nur 80 g** (ohne Krallen)
- SHIS: IS42/28,6 | IS52/40
- im M-Wave Einzelkarton

1 1/8" oben und 1,5" unten

- A** = 28,5 mm
= Innen-Ø des oberen Abschlussrings
- B1** = 41,8 mm
= Außen-Ø des oberen Kugellagers
- B2** = 52,0 mm
= Außen-Ø des unteren Kugellagers
- C** = 39,8 mm
= Konussitz auf Gabel

**INTEGRATED CARTRIDGE
HEAD SET, 1 1/8" → 1.5"**
›IS42/52 C‹

- **aluminium**
- 45° x 45°
- with **sealed bearing**
- incl. star nut
- black
- **only 80 g** (w/o star nut)
- SHIS: IS42/28.6 | IS52/40
- in M-Wave box

1 1/8" top and 1.5" bottom

- A** = 28.5 mm
= inner-Ø of the upper cap ring
- B1** = 41.8 mm
= outer-Ø of the upper bearing
- B2** = 52.0 mm
= outer-Ø of the lower bearing
- C** = 39.8 mm
= cone seat on the fork



• **390800** INTEGRIERTER CARTRIDGE
STEUERSATZ 1 1/8"
›IS42/42 C‹

14,90 €

- **Aluminium**
- schwarz
- Campa Standard = 41,8 mm x 45° x 45°
- 2 x 0,28 mm Ausgleichsscheiben
- nur 89 g (ohne Klemme)
- SHIS: IS42/28,6 | IS42/30
- im M-Wave Einzelkarton

- A** = 28,5 mm
- B1=B2** = 41,8 mm
- C** = 30,0 mm

**INTEGRATED CARTRIDGE
HEAD SET 1 1/8"**
›IS42/42 C‹

- **aluminium**
- black
- Campa standard = 41.8 mm x 45° x 45°
- 2 x 0.28 mm shims
- only 89 g (w/o clamp)
- SHIS: IS42/28.6 | IS42/30
- in M-Wave box

- A** = 28.5 mm
- B1=B2** = 41.8 mm
- C** = 30.0 mm



AHEAD SEMI-INTEGRIERT

AHEAD SEMI INTEGRATED

• **390809** SEMI-INTEGRIERTER CARTRIDGE
STEUERSATZ 1 1/8" → 1,5"
›ZS44/56 C‹

19,90 €

- 1 1/8" oben / 1,5" unten
- schwarz
- **Aluminium**
- SHIS: ZS44/28,6 | ZS56/40
- im M-Wave Einzelkarton

- A** = 28,6 mm
= Innen-Ø des oberen Abschlussrings
- B1** = 44 mm
= Außen-Ø des oberen Kugellagers
- B2** = 56,0 mm
= Außen-Ø des unteren Kugellagers
- C** = 39,8 mm
= Konussitz auf Gabel

**SEMI INTEGRATED CARTRIDGE
HEAD SET 1 1/8" → 1.5"**
›ZS44/56 C‹

- 1 1/8" top / 1.5" bottom
- black
- **aluminium**
- SHIS: ZS44/28.6 | ZS56/40
- in M-Wave box



- A** = 28.6 mm
= inner-Ø of the upper cap ring
- B1** = 44 mm
= outer-Ø of the upper bearing
- B2** = 56.0 mm
= outer-Ø of the lower bearing
- C** = 39.8 mm
= cone seat on the fork



ART.-NR. UVP	BESCHREIBUNG	DESCRIPTION	
• 390810 9,90 €	SEMI-INTEGRIERTER TAPERED STEUERSATZ 1 1/8" → 1,5" ›ZS44/56 LB‹ <ul style="list-style-type: none"> • 1 1/8" oben / 1,5" unten • schwarz • Aluminium/Stahl • SHIS: ZS44/28,6 ZS56/40 • im M-Wave Einzelkarton A = 28,6 mm = Innen-Ø des oberen Abschlussrings B1 = 44 mm = Außen-Ø der oberen Kugellagerschale B2 = 56,0 mm = Außen-Ø der unteren Kugellagerschale C = 39,8 mm = Konussitz auf Gabel	SEMI INTEGRATED TAPERED HEAD SET 1 1/8" → 1.5" ›ZS44/56 LB‹ <ul style="list-style-type: none"> • 1 1/8" top / 1.5" bottom • black • aluminium/steel • SHIS: ZS44/28.6 ZS56/40 • in M-Wave box A = 28.6 mm = inner-Ø of the upper cap ring B1 = 44 mm = outer-Ø of the upper bearing shell B2 = 56.0 mm = outer-Ø of the lower bearing shell C = 39.8 mm = cone seat on the fork	

• 390580 19,90 €	SEMI-INTEGRIERTER CARTRIDGE STEUERSATZ 1 1/8" ›ZS44/44 C‹ <ul style="list-style-type: none"> • Aluminium • schwarz • 1 1/8" • SHIS: ZS44/28,6 ZS44/30 • im M-Wave Einzelkarton A = 28,6 mm B = 44,0 mm C = 30,0 mm	SEMI INTEGRATED CARTRIDGE HEAD SET 1 1/8" ›ZS44/44 C‹ <ul style="list-style-type: none"> • aluminium • black • 1 1/8" • SHIS: ZS44/28.6 ZS44/30 • in M-Wave box A = 28.6 mm B = 44.0 mm C = 30.0 mm	
---------------------	---	--	--

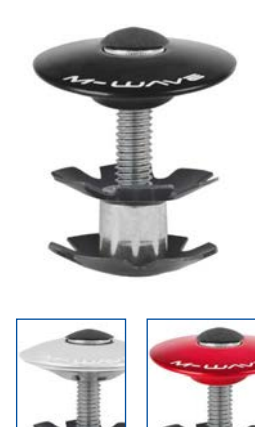
390890 6,90 €	KLEMME FÜR AHEAD- STEUERSATZ ›FORK FIX C‹ <ul style="list-style-type: none"> • wiederverwendbare Ahead-Klemme • durch große Kontaktfläche auch für Carbonrohre geeignet • 1 1/8" • auf M-Wave Eurolochkarte auf M-Wave Eurolochkarte	COMPRESSOR PLUG FOR AHEAD HEAD SET ›FORK FIX C‹ <ul style="list-style-type: none"> • reusable ahead clamp • due wide area also suitable for carbon tubes • 1 1/8" • on M-Wave eurohole card on M-Wave eurohole card	
------------------	---	--	---

	KRALLE + ALUMINIUMKAPPE + SCHRAUBE FÜR AHEAD- STEUERSATZ ›FORK FIX‹ <ul style="list-style-type: none"> • Krallen, Alukappe und Schraube in einem • für 1 1/8" auf M-Wave Eurolochkarte	STAR NUT + ALUMINIUM CAP + SCREW FOR AHEAD HEAD SET ›FORK FIX‹ <ul style="list-style-type: none"> • star nut, aluminium cap and screw • for 1 1/8" on M-Wave eurohole card	
390570	schwarz eloxiert	black anodised	
390571	silber eloxiert	silver anodised	
390573	rot eloxiert	red anodised	
	Montageverpackung	OEM	
• 390561	schwarz eloxiert	black anodised	
• 390461	silber eloxiert	silver anodised	
390555	rot eloxiert	red anodised	
4,90 €			

ART.-NR. UVP	BESCHREIBUNG	DESCRIPTION
-----------------	--------------	-------------

390517 **STEUERSATZKAPPE**
›CHEERS‹
9,90 €

- mit magnetischer Halterung für **Kronkorken**
- für 1 1/8" Ahead-Steuersätze
- Aluminium
- inkl. Befestigungsschraube
- auf M-Wave Eurolochkarte

HEAD SET CAP
›CHEERS‹

- with magnetic holder for **bottle caps**
- for 1 1/8" ahead head sets
- aluminium
- incl. mounting screw
- on M-Wave eurohole card



DISTANZRINGE ›RIO SPACER‹

- Aluminium
- für 1 1/8"

SPACERS ›RIO SPACER‹

- aluminium
- for 1 1/8"

5 mm, 6 Stück auf M-Wave Eurolochkarte
390640
U

schwarz eloxiert

5 mm, 6 pcs on M-Wave eurohole card
black anodised

390641
U
5,90 €

silber eloxiert

silver anodised



5 mm, Montageverpackung

5 mm, OEM

• **390602** schwarz eloxiert

black anodised

• **390601** silber eloxiert

silver anodised

0,90 €

SEMI-INTEGRIERT

SEMI INTEGRATED

• **390806** **SEMI-INTEGRIERTER**
CARTRIDGE STEUERSATZ 1 1/8"
›**ZS44/44 TC**‹
15,90 €

- 1 1/8"
- schwarz
- **Aluminium**
- nur 94 g
- mit Industriekugellager
- SHIS: ZS44/28.6-26T | ZS44/30
- im M-Wave Einzelkarton

- A** = 28,6 mm
= Innen-Ø des oberen Abschlussrings
- B** = 44 mm
= Außen-Ø der Kugellagerschalen
- C** = 30,0 mm
= Konussitz auf Gabel

SEMI INTEGRATED CARTRIDGE
HEAD SET 1 1/8"
›**ZS 44/44 TC**‹

- 1 1/8"
- black
- **aluminium**
- only 94 g
- with sealed bearing
- SHIS: ZS44/28.6-26T | ZS44/30
- in M-Wave box

- A** = 28.6 mm
= inner-Ø of the upper cap ring
- B** = 44 mm
= outer-Ø of the bearing shells
- C** = 30.0 mm
= cone seat on the fork



M-WAVE QRIR

VIELSEITIGE KOMBINATIONSMÖGLICHKEITEN / VERSATILE COMBINATIONS

**LENKER /
HANDLEBAR**

**AHEAD-DISTANZRING /
AHEAD SPACER**

**AHEAD-KAPPE /
AHEAD CAP**

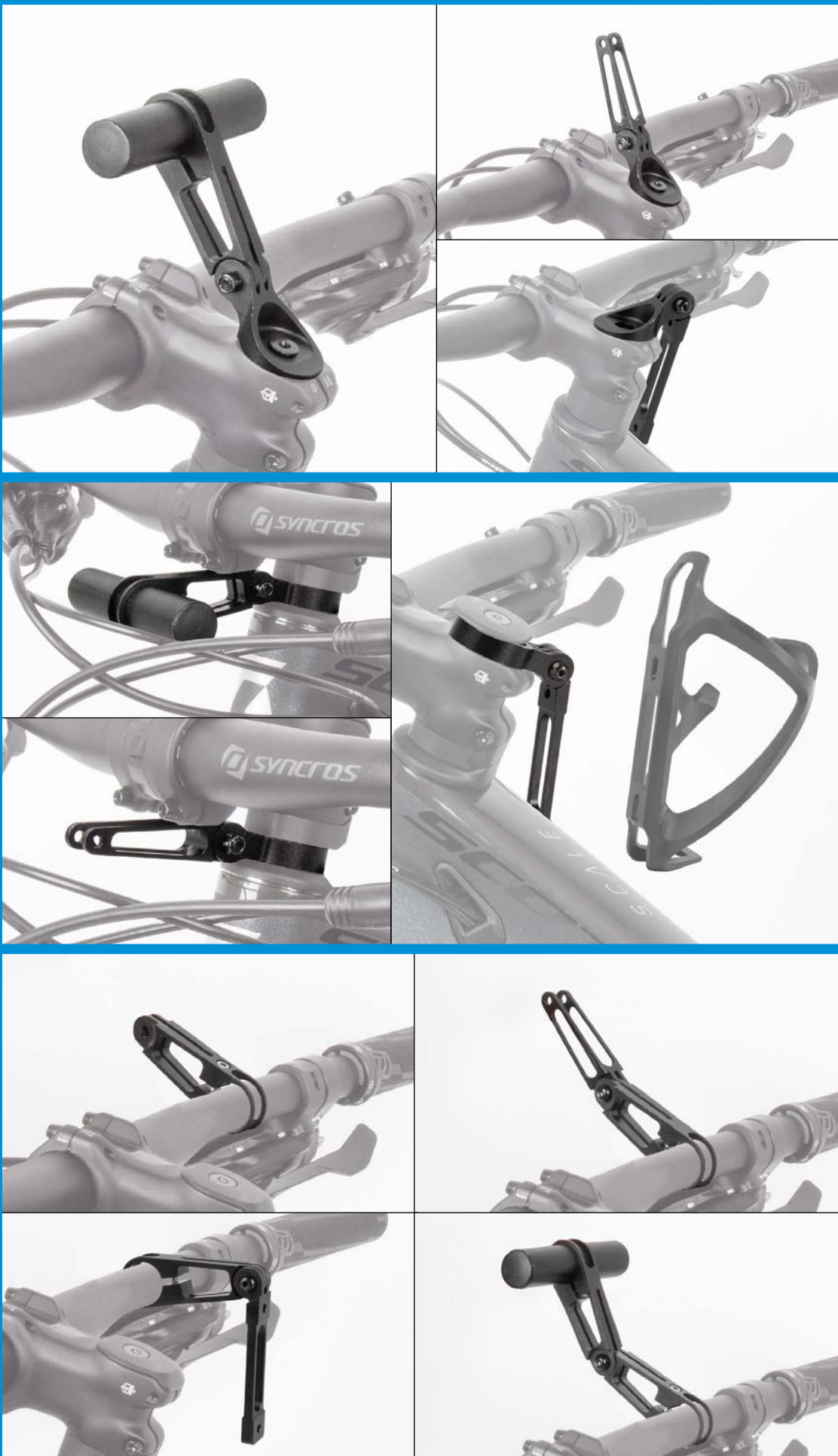

ART.-NR. UVP **BESCHREIBUNG**

DESCRIPTION

MODULARES HALTER-SYSTEM

›QRIR‹

- **vielseitige Kombinationsmöglichkeiten** von Haltern und Adaptern für Lampen, Trinkflaschen, Fahrrad-computer, Action-Kameras, ...
- optimale Anpassung an die **individuellen Bedürfnisse** jedes Rad-fahrers
- **CNC-gefrästes Aluminium**
- Verbindungs-Konstruktion auch für GoPro geeignet (keine original GoPro Ersatzteile)
- auf M-Wave Eurolochkarte

ADAPTER

- für Ahead Steuersatz
- 1 1/8" und verjüngt
- für Flaschenhalter-Adapter (Art. 390636), Lenkercockpit (Art. 390637) oder Lampenhalter (Art. 390638)

390650 **Distanzring** ›QRIR Spacer‹
U Höhe: 10 mm
7,90 €

390635 **Ahead-Kappe** ›QRIR Top‹
U
8,90 €

MODULAR BRACKET SYSTEM

›QRIR‹

- **versatile combinations** of brackets and adapters for lamps, water bottles, cycle computers, action cams, ...
- optimal adaptation to the **individual needs** of every cyclist
- **CNC machined aluminium**
- connection construction also suitable for GoPro (no original GoPro spare parts)
- on M-Wave eurohole card

ADAPTER

- for ahead head set
- 1 1/8" and tapered
- for bottle cage adapter (art. 390636), handlebar cockpit (art. 390637) or lamp bracket (art. 390638)

Spacer ›QRIR Spacer‹
height: 10 mm

Ahead cap ›QRIR Top‹

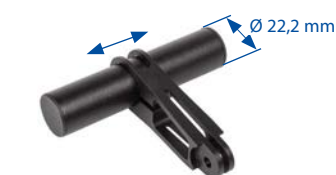
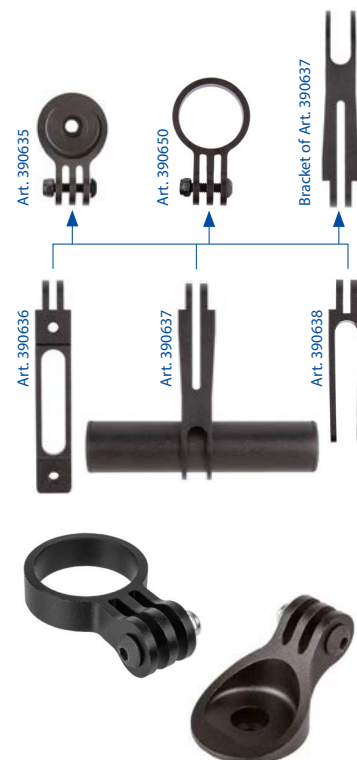

HALTER

für Distanzring (Art. 390650) und Ahead-Kappe (Art. 390635)

390637 **Lenkercockpit** ›QRIR Cockpit‹
U
12,90 €

- universelle Montage von Lampen, Fahrradcomputern, E-Bike Displays, ...
- Klemmdurchmesser: 22,2 mm
- Rohr: 90 x 22,2 mm
- **Zusatzfunktion:** Bei Entnahme des "Cockpit-Rohres" ist eine umgekehrte Montage am Lenker möglich. So können die Halter Art. 390636/8, Scheinwerfer, ... problemlos im **Ø 22,2 mm-Klembereich des Lenkers** montiert werden.

BRACKET

for spacer (art. 390650) and ahead cap (art. 390635)

Handlebar cockpit ›QRIR Cockpit‹

- universal mounting of lamps, bicycle computers, e-bike displays ...
- clamp diameter: 22.2 mm
- tube: 90 x 22.2 mm
- **additional function:** When removing the "cockpit tube" a reverse mounting on the handlebar is possible. Thus, the brackets art. 390636/8, head lights, ... can be easily mounted at the **Ø 22.2 mm clamp area of the handlebar.**

390636 **Flaschenhalter** ›QRIR Bottle‹
U
7,90 €

- zur Montage eines Flaschenhalters
- Winkel stufenlos einstellbar

Bottle cage ›QRIR Bottle‹

- for mounting of a bottle cage
- steplessly adjustable angle



390638 **Lampenhalter** ›QRIR Extender‹
U
7,90 €

- zur Montage eines Scheinwerfers
- auch in Kombination mit der Klemme des Lenkercockpits (Art. 390637) im **Ø 22,2 mm-Klembereich des Lenkers** montierbar

Lamp bracket ›QRIR Extender‹

- for mounting of a head light
- can also be used in combination with the clamp of the handlebar cockpit (art. 390637) for mounting at the **Ø 22.2 mm clamp area of the handlebar**



ART.-NR. UVP BESCHREIBUNG DESCRIPTION

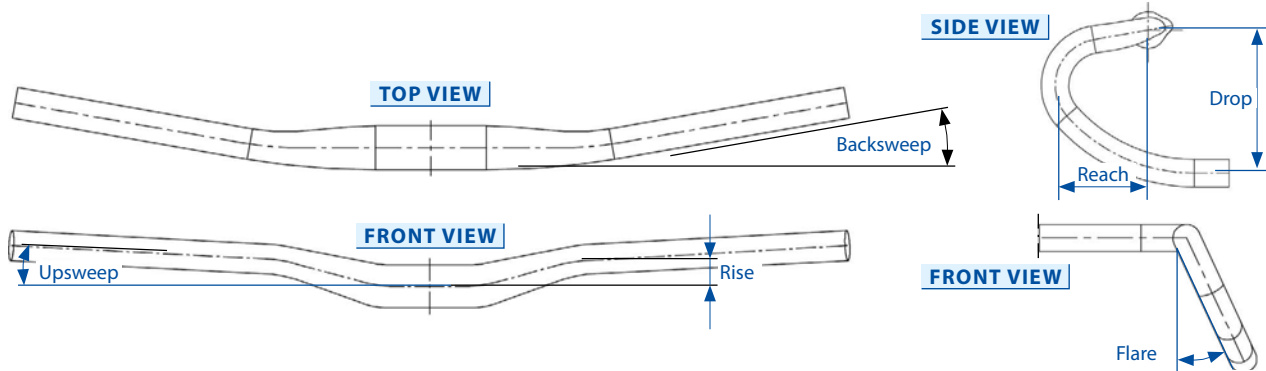

Handlebars & Accessories



MTB LENKER
HB-M3.1<

- Aluminium
- konifiziert
- 780 mm
- mattschwarz
- für Klemmung Ø 31,8 mm
- 9° nach hinten gebogen
- 0° nach oben gebogen
- Höhe 5 mm
- mit Skala in der Mitte und an den Seiten

401516 auf M-Wave Eurolochkarte

401517 Montageverpackung

19,90 €

MTB HANDLEBAR
HB-M3.1<

- aluminium
- butted
- 780 mm
- matt black
- bar center Ø 31.8 mm
- 9° backsweep
- 0° upsweep
- rise 5 mm
- with scale in the middle and at the sides

on M-Wave eurohole card

OEM

Tested by the manufacturer based on ISO 4210



• **403207**
AD
12,90 €
mAD 18,90 €

- M-Wave
- 680 mm
- 6° nach hinten gebogen
- Montageverpackung

- M-Wave
- 680 mm
- 6° backsweep
- OEM



MTB LENKER

- Aluminium
- 620 mm breit
- für Klemmung Ø 25,4 mm
- Montageverpackung

403684 schwarz

403685 U silber

8,90 €
mAD 12,90 €

MTB HANDLEBAR

- aluminium
- width 620 mm
- bar center Ø 25.4 mm
- OEM

black

silver



MTB RISE LENKER
HB-M4.1<

- Aluminium
- doppelt konifiziert
- 780 mm
- mattschwarz
- für Klemmung Ø 31,8 mm
- 7° nach hinten gebogen
- mit Skala in der Mitte und an den Seiten

Höhe 10 mm, 4° nach oben gebogen

403225 auf M-Wave Eurolochkarte

403227 Montageverpackung

Höhe 20 mm, 3° nach oben gebogen

403226 auf M-Wave Eurolochkarte

403228 Montageverpackung

49,90 €

MTB RISE HANDLEBAR
HB-M4.1<

- aluminium
- double butted
- 780 mm
- matt black
- bar center Ø 31.8 mm
- 7° backsweep
- with scale in the middle and at the sides

rise 10 mm, 4° upsweep

on M-Wave eurohole card

OEM

rise 20 mm, 3° upsweep

on M-Wave eurohole card

OEM

Tested by the manufacturer based on ISO 4210

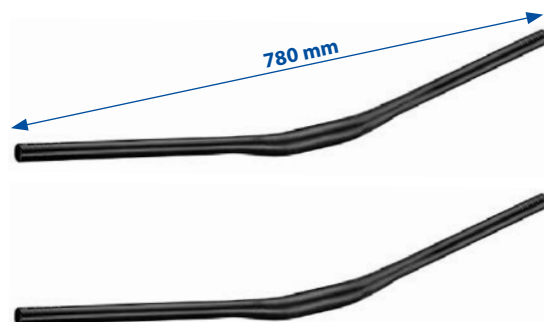

ART.-NR. UVP **BESCHREIBUNG**

DESCRIPTION

403630 **MTB RISE LENKER**
›A-RISE 780 OVERSIZE‹
 U
 23,90 €
 mAD 34,90 €

- **Aluminium**
- **780 mm**
- für Klemmung **Ø 35 mm**
- 9° nach hinten gebogen
- 3° nach oben gebogen
- **Höhe 20 mm**
- mit Skala in der Mitte und an den Seiten
- schwarz
- auf M-Wave Eurolochkarte

MTB RISE HANDLEBAR
›A-RISE 780 OVERSIZE‹

- **aluminium**
- **780 mm**
- bar center **Ø 35 mm**
- 9° backsweep
- 3° upsweep
- **rise 20 mm**
- with scale in the middle and at the sides
- black
- on M-Wave eurohole card

Tested by the manufacturer based on ISO 4210



MTB RISE LENKER
›HB-M3.2‹

- **Aluminium**
- **doppelt konifiziert**
- mattschwarz
- für Klemmung **Ø 31,8 mm**
- 9° nach hinten gebogen
- 3° nach oben gebogen
- **Höhe 20 mm**
- mit Skala in der Mitte und an den Seiten

MTB RISE HANDLEBAR
›HB-M3.2‹

- **aluminium**
- **double butted**
- matt black
- bar center **Ø 31.8 mm**
- 9° backsweep
- 3° upsweep
- **rise 20 mm**
- with scale in the middle and at the sides

Tested by the manufacturer based on ISO 4210



Handlebars & Accessories

780 mm
401518 auf M-Wave Eurolochkarte

780 mm
 on M-Wave eurohole card

401519 Montageverpackung

OEM

680 mm
401529 auf M-Wave Eurolochkarte

680 mm
 on M-Wave eurohole card

401524 Montageverpackung
 19,90 €

OEM

MTB RISE LENKER
›A-RISE 700C‹

- **Aluminium**
- **konifiziert**
- **700 mm**
- Klemmung **Ø 31,8 mm**
- 10° nach hinten gebogen
- 16° nach oben gebogen
- Höhe 30 mm
- nur 297 g
- mit **Skala** in der Mitte und an den Seiten

MTB RISE HANDLEBAR
›A-RISE 700C‹

- **aluminium**
- **butted**
- **700 mm**
- bar center **Ø 31.8 mm**
- 10° backsweep
- 16° upsweep
- rise 30 mm
- only 297 g
- with **scale** in the middle and at the sides

Tested by the manufacturer based on ISO 4210

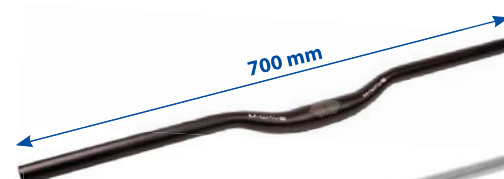

auf M-Wave Eurolochkarte

on M-Wave eurohole card

403500 mattschwarz eloxiert
 U

matt black anodised

403501 silber eloxiert
 U
 19,90 €

silver anodised

Montageverpackung

OEM

• **403664** mattschwarz eloxiert

matt black anodised

• **403502** silber eloxiert
 U
 19,90 €
 mAD 28,90 €

silver anodised



ART.-NR. UVP **BESCHREIBUNG**

DESCRIPTION

**TREKKING RISE LENKER
>HB-C2.1<**

- Aluminium
- mattschwarz
- Klemmung Ø 31,8 mm
- 640 mm
- 38° nach hinten gebogen
- 36° nach oben gebogen

Höhe 38 mm

403971 Montageverpackung

403974 auf M-Wave Eurolochkarte

Höhe 21 mm

403973 Montageverpackung

403976 auf M-Wave Eurolochkarte
19,90 €

**TREKKING RISE HANDLEBAR
>HB-C2.1<**

- aluminium
- matt black
- bar center Ø 31.8 mm
- 640 mm
- 38° backsweep
- 36° upsweep

rise 38 mm

OEM

on M-Wave eurohole card

rise 21 mm

OEM

on M-Wave eurohole card

SIDE VIEW

Tested by the manufacturer based on ISO 4210



FRONT VIEW



- 660 mm
- 18° nach hinten gebogen
- 12° nach oben gebogen
- Höhe 25 mm

403972 Montageverpackung

19,90 €
mAD 28,90 €

403975 auf M-Wave Eurolochkarte
28,90 €

- 660 mm
- 18° backsweep
- 12° upsweep
- rise 25 mm

OEM

on M-Wave eurohole card



**TOURING / TREKKING
RISE LENKER**

- Aluminium
- 600 mm
- Klemmung Ø 25,4 mm
- 15° nach hinten gebogen
- 30° nach oben gebogen
- Höhe 30 mm
- Montageverpackung

• **401206** schwarz

• **401207** silber

9,90 €
mAD 14,90 €

**TOURING / TREKKING
RISE HANDLEBAR**

- aluminium
- 600 mm
- bar center Ø 25.4 mm
- 15° backsweep
- 30° upsweep
- rise 30 mm
- OEM

black

silver

Tested by the manufacturer based on ISO 4210



401282 TREKKING LENKER

44,90 €

- Aluminium
- **zusätzlicher Lenkerbogen** (Ø 22,2 mm) bietet **Platz** für Taschen, Lampen, Computer, Handys, innen montierte Lenkerzusatzgriffe, ...
- Breite 660 mm
- Klemmung Ø 31,8 mm
- 45° nach hinten gebogen
- Höhe 13 mm
- Montageverpackung

TREKKING HANDLEBAR

- aluminium
- **additional handlebar bow** (Ø 22.2 mm) offers **space** for bags, lamps, computers, mobile phones, inner bar ends, ...
- width 660 mm
- bar center Ø 31.8 mm
- 45° backsweep
- rise 13 mm
- OEM

Tested by the manufacturer based on ISO 4210



ART.-NR. UVP **BESCHREIBUNG** **DESCRIPTION**

TRIATHLON-AUFSATZ

- **Aluminium**
- schwarz
- für Lenker Ø 31,8 mm (mit Adapter für Ø 25,4 mm)
- **Breite und Winkel** der Armauflage **verstellbar**
- Polster austauschbar (Ersatzpolster Art. 403970)
- Ausleger mit **Skala**
- nur **448 g**
- auf M-Wave Eurolochkarte

TRI BAR

- **aluminium**
- black
- for handlebar Ø 31.8 mm (with adapter for Ø 25.4 mm)
- **adjustable** arm rest **width** and **angle**
- pads replaceable (replacement pads art. 403970)
- extension with **scale**
- only **448 g**
- on M-Wave eurohole card



403750 ›AERO F‹
U

›AERO F‹



403742 ›AERO H‹
U
44,90 €

›AERO H‹

VERSTELLBARER LENKERVORBAU

- **Aluminium**
- schwarz
- verstellbar von **0°- 90°**
- für 1 1/8" (25,4 mm)
- Lenkerklemmung Ø 31,8 mm
- Schaftlänge 180 mm

ADJUSTABLE HANDLE STEM

- **aluminium**
- black
- adjustable from **0°- 90°**
- for 1 1/8" (25.4 mm)
- clamp Ø 31.8 mm
- shaft length 180 mm

Tested by the manufacturer based on ISO 4210

Länge **90 mm**

length **90 mm**

404014 auf M-Wave Karte

on M-Wave tag

404016 Montageverpackung

OEM

Länge **110 mm**

length **110 mm**

404015 auf M-Wave Karte

on M-Wave tag

404017 Montageverpackung

OEM

22,90 €



• **400446** **HÖHENADAPTER** ›CP LIFT‹
U
19,90 €

- **Aluminium**
- für 1 1/8"
- **Höhe verstellbar** durch 1 x 5 mm und 3 x 10 mm Distanzringe
- inkl. Aheadkappe und Schraube
- in M-Wave Eurolochbox

HEIGHT ADAPTER ›CP LIFT‹

- **aluminium**
- for 1 1/8"
- **height adjustable** by 1 x 5 mm and 3 x 10 mm spacers
- incl. ahead cap and screw
- in M-Wave eurohole box

Tested by the manufacturer based on ISO 4210 MTB



ART.-NR. UVP
BESCHREIBUNG

DESCRIPTION



VERSTELLBARER AHEAD LENKERVORBAU

- getestet gemäß **DIN EN 15194** und zusätzlich nach dem höheren Standard der Klasse 2 bis **140 kg**
- **Aluminium**
- von **0°- 90° verstellbar**
- Lenkerklemmung für Ø 31,8 mm
- 1 1/8" (28,6 mm)
- mattschwarz

ADJUSTABLE AHEAD HANDLE STEM

- tested based on **DIN EN 15194** and also based on the higher standard of the class 2 up to **140 kg**
- **aluminium**
- **adjustable** from **0°- 90°**
- clamp for Ø 31.8 mm
- 1 1/8" (28.6 mm)
- matt black

Tested by the manufacturer based on DIN EN 15194



auf M-Wave Eurolochkarte

on M-Wave eurohole card

400319 90 mm

90 mm

400320 110 mm

110 mm

Montageverpackung

OEM

• **400317** 90 mm

90 mm

• **400318** 110 mm

110 mm

22,90 €

AHEAD LENKERVORBAU ›ST-C2.1‹

- **Aluminium, 3D geschmiedet**
- Lenkerklemmung für Ø 35 mm
- 1 1/8" (28,6 mm)
- -12°
- mattschwarz
- auf M-Wave Eurolochkarte

AHEAD HANDLE STEM ›ST-C2.1‹

- **aluminium, 3D forged**
- clamp for Ø 35 mm
- 1 1/8" (28.6 mm)
- -12°
- matt black
- on M-Wave eurohole card



404320
U 40 mm

40 mm

404322
U 50 mm
34,90 €

50 mm

AHEAD LENKERVORBAU ›ST-M4.1‹

- **Aluminium, 3D geschmiedet**
- 1 1/8" (28,6 mm)
- 0°
- Klemmhöhe: 43 mm
- Lenkerklemmung für Ø 31,8 mm
- mattschwarz

AHEAD HANDLE STEM ›ST-M4.1‹

- **aluminium, 3D forged**
- 1 1/8" (28.6 mm)
- 0°
- stack height: 43 mm
- clamp for Ø 31.8
- matt black

Tested by the manufacturer based on ISO 4210



auf M-Wave Eurolochkarte

on M-Wave eurohole card

400447 35 mm

35 mm

400448 50 mm

50 mm

Montageverpackung

OEM

400449 35 mm

35 mm

400450 50 mm

50 mm

36,90 €



ART.-NR. UVP	BESCHREIBUNG	DESCRIPTION	
	AHEAD LENKERVORBAU ›ST-M4.2‹	AHEAD HANDLE STEM ›ST-M4.2‹	<div style="border: 1px solid black; padding: 2px; font-size: 8px;">Tested by the manufacturer based on ISO 4210</div> 
	<ul style="list-style-type: none"> • Aluminium 3D geschmiedet • 1 1/8" (28,6 mm) • 0° • Klemmhöhe: 36 mm • Lenkerklemmung für Ø 31,8 mm • mattschwarz • auf M-Wave Eurolochkarte 	<ul style="list-style-type: none"> • aluminium 3D forged • 1 1/8" (28.6 mm) • 0° • stack height: 36 mm • clamp for Ø 31.8 mm • matt black • on M-Wave eurohole card 	
400466	35 mm	35 mm	
400467	50 mm	50 mm	
	27,90 €		
	AHEAD LENKERVORBAU ›ST-M3.1‹	AHEAD HANDLE STEM ›ST-M3.1‹	<div style="border: 1px solid black; padding: 2px; font-size: 8px;">Tested by the manufacturer based on ISO 4210</div> 
	<ul style="list-style-type: none"> • Aluminium 3D geschmiedet • 1 1/8" (28,6 mm) • Lenkerklemmung für Ø 31,8 mm • ab 113 g • mattschwarz 	<ul style="list-style-type: none"> • aluminium 3D forged • 1 1/8" (28.6 mm) • clamp for Ø 31.8 mm • from 113 g • matt black 	
	7°	7°	
	auf M-Wave Eurolochkarte	on M-Wave eurohole card	
404520	60 mm	60 mm	
404522	90 mm	90 mm	
404524	100 mm	100 mm	
404526	110 mm	110 mm	
	Montageverpackung	OEM	
404521	60 mm	60 mm	
404523	90 mm	90 mm	
404525	100 mm	100 mm	
404527	110 mm	110 mm	
	19,90 €		
	AHEAD LENKERVORBAU ›ST-M3.2‹	AHEAD HANDLE STEM ›ST-M3.2‹	
	<ul style="list-style-type: none"> • Aluminium 3D geschmiedet • 1 1/8" (28,6 mm) • Lenkerklemmung für Ø 31,8 mm • ab 113 g • mattschwarz 	<ul style="list-style-type: none"> • aluminium 3D forged • 1 1/8" (28.6 mm) • clamp for Ø 31.8 mm • from 113 g • matt black 	
	35°	35°	
	auf M-Wave Eurolochkarte	on M-Wave eurohole card	
404351	60 mm	60 mm	
404353	80 mm	80 mm	
404355	100 mm	100 mm	
404357	120 mm	120 mm	
	Montageverpackung	OEM	
404350	60 mm	60 mm	
404352	80 mm	80 mm	
404354	100 mm	100 mm	
404356	120 mm	120 mm	
	22,90 €		

ART.-NR. UVP **BESCHREIBUNG**

DESCRIPTION

Tested by the manufacturer based on ISO 4210



AHEAD LENKERVORBAU ›ASTEM 3D‹

- Aluminium, **3D geschmiedet**
- 1 1/8" (28,6 mm)
- 7°
- Lenkerklemmung für **Ø 31,8 mm**
- mit rostgeschützten Schrauben
- mattschwarz

AHEAD HANDLE STEM ›ASTEM 3D‹

- aluminium, **3D forged**
- 1 1/8" (28.6 mm)
- 7°
- clamp for **Ø 31.8 mm**
- with rust protected screws
- matt black

auf M-Wave Eurolochkarte

on M-Wave eurohole card

404376 60 mm (nur **118,5 g**)

60 mm (only **118.5 g**)



404253 90 mm
U

90 mm



404258 100 mm
U

100 mm



404277 110 mm
U

110 mm



Montageverpackung

OEM

• **404208** 60 mm

60 mm

• **404283** 90 mm

90 mm

• **404284** 100 mm

100 mm

• **404285** 110 mm
14,90 €

110 mm



AHEAD LENKERVORBAU ›ST-M3.3‹

- Aluminium, **3D geschmiedet**
- 1 1/8" (28,6 mm)
- 7°
- Lenkerklemmung für **Ø 25,4 mm**
- mattschwarz

AHEAD HANDLE STEM ›ST-M3.3‹

- aluminium, **3D forged**
- 1 1/8" (28.6 mm)
- 7°
- clamp for **Ø 25.4 mm**
- matt black

Tested by the manufacturer based on ISO 4210

auf M-Wave Eurolochkarte

on M-Wave eurohole card

404400 60 mm

60 mm



404401 90 mm

90 mm



404402 105 mm

105 mm



Montageverpackung

OEM

404403 60 mm

60 mm

404404 90 mm

90 mm

404405 105 mm
18,90 €

105 mm

ART.-NR. BESCHREIBUNG
UVP

DESCRIPTION

INNER BAR ENDS

INNER BAR ENDS

- 408060** U
14,90 € **LENKERZUSATZGRIFF ›BE ANATOM IN‹**
- zur **Befestigung innen am Lenker** für **aerodynamische Fahrposition**
 - **anatomische** Form
 - einteilig
 - **Aluminium**
 - schwarz
 - mit Klemmung für Ø 22,2 mm
 - auf M-Wave Eurolochkarte

- BAR END ›BE ANATOM IN‹**
- for **fixing at the innerside of the handlebar** for **aerodynamic driving position**
 - **anatomic** shape
 - one-piece
 - **aluminium**
 - black
 - with clamp for Ø 22.2 mm
 - on M-Wave eurohole card



OUTER BAR ENDS

OUTER BAR ENDS

- 408231** U
19,90 € **LENKERZUSATZGRIFF ›BE TOOL‹**
- **Aluminium**
 - mattschwarz
 - **Werkzeugset im Inneren mit 15 Funktionen:**
4/5/6/8 mm Innensechskantschlüssel
T 25 Vielzahnschlüssel
14G/0,136" Speichenschlüssel
Kreuz-/Schlitzschraubendreher
8/9/10 mm Ring-/Maulschlüssel
Kettennietdrücker
2 Reifenheber
 - in M-Wave Blisterverpackung

- BAR END ›BE TOOL‹**
- **aluminium**
 - matt black
 - **tool set inside with 15 functions:**
4/5/6/8 mm allen keys
T 25 star screwdriver
14G/0.136" spoke wrench
Phillips/flat type screwdriver
8/9/10 mm round wrench
chain riveting tool
2 tire levers
 - in M-Wave blister packaging

according to ISO 4210



- 408167** U
9,90 € **LENKERZUSATZGRIFF ›BE ANATOM‹**
- **anatomische Form**
 - einteilig
 - **Aluminium**
 - schwarz
 - mit Außenklemmung
 - auf M-Wave Eurolochkarte

- BAR END ›BE ANATOM‹**
- **anatomic shape**
 - one-piece
 - **aluminium**
 - black
 - with outer clamp
 - on M-Wave eurohole card



- 408113** **LENKERZUSATZGRIFF ›M-WAVE‹**
- gerade, kurze Ausführung
 - **Aluminium**
 - mit Außenklemmung
 - **anatomische** Kappe
 - mattschwarz
 - Montageverpackung

- BAR END ›M-WAVE‹**
- straight, short type
 - **aluminium**
 - with outer clamp
 - **anatomic** cap
 - matt black
 - OEM



ART.-NR. BESCHREIBUNG
UVP

DESCRIPTION

- **410831** **LENKERBAND**
U
8,90 €
XL
200x3cm
• **strukturierte Non-Slip-Oberfläche** bietet angenehmes und sicheres Griffgefühl
• extra **lang** und **breit: 200 x 3 cm**
• 1 Set = 2 Bänder
• mit Lenkerendstopfen und Klebeband
• in M-Wave Eurolochbox

- **HANDLEBAR TAPE**
• **›CLOUD TAPE BASE‹**
• **structured non-slip surface** provides pleasant and secure grip
• extra **long** and **wide: 200 x 3 cm**
• 1 set = 2 tapes
• with handlebar plugs and adhesive tapes
• in M-Wave eurohole box

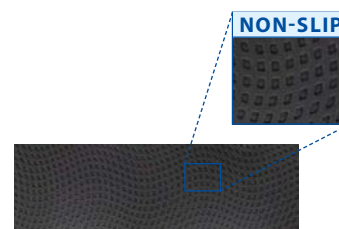

- **LENKERENDSTOPFEN ›A RIO‹**
• aus **Aluminium** mit **Nirosta-Schraube**
• für Innendurchmesser 17,5 - 19,5 mm
• 1 Paar auf M-Wave Eurolochkarte

- **HANDLEBAR PLUGS ›A RIO‹**
• made of **aluminium** with **stainless steel screw**
• for inner diameter 17.5 - 19.5 mm
• 1 pair on M-Wave eurohole card



- 410893** rot eloxiert
 - 410894** blau eloxiert
 - 410895** grün eloxiert
- 9,90 €

- red anodised
- blue anodised
- green anodised

- **410897** **LENKERENDSTOPFEN**
U
1,90 €
• **›FIT-PLUGS‹**
• aus **elastischem TPR Kunststoff**
• durch **Flexibilität** passend für **viele verschiedene Innendurchmesser**
• wiederverwendbar
• 1 Set = 4 Stück auf M-Wave Eurolochkarte

- **HANDLEBAR PLUGS**
• **›FIT-PLUGS‹**
• made of **elastic TPR plastic**
• due to **flexibility** suitable for **many different inner diameters**
• reusable
• 1 set = 4 pieces on M-Wave eurohole card



- **SCHRAUBGRIFF**
• **›CLOUD BASE 2‹**
• **anatomisch geformter Echtlederoptik-Schraubgriff**
• **handgenäht**
• leichte **(De-)Montage** und **fester Halt** am Lenker durch **doppelte Aluminium-Schraubbefestigung**
• mit Lenkerendstopfen
• 135 mm

- **SCREW-ON GRIP**
• **›CLOUD BASE 2‹**
• **anatomically shaped genuine leather design screw-on grip**
• **handsewn**
• easy **(dis-)assembly** and **perfect grip** at the handlebar through **double aluminium screw attachment**
• with handlebar plugs
• 135 mm



- 410622** auf M-Wave Eurolochkarte
 - 410610** paarweise im Polybeutel
- 14,90 €

- on M-Wave eurohole card
- 1 pair in PE bag

- **SCHRAUBGRIFF**
• **›CLOUD BUFF FIX‹**
• **anatomisch geformter Echtlederoptik-Schraubgriff**
• leichte **(De-)Montage** und **fester Halt** am Lenker durch **doppelte Aluminium-Schraubbefestigung**
• mit elastischen Lenkerendstopfen
• auf M-Wave Eurolochkarte

- **SCREW-ON GRIP**
• **›CLOUD BUFF FIX‹**
• **anatomically shaped genuine leather design screw-on grip**
• easy **(dis-)assembly** and **perfect grip** at the handlebar through **double aluminium screw attachment**
• with elastic handlebar plugs
• on M-Wave eurohole card



- 410628** **138 / 138 mm**
 - 410629** **138 / 99 mm**
- 14,90 €

- 138 / 138 mm**
- 138 / 99 mm**

ART.-NR. UVP	BESCHREIBUNG	DESCRIPTION	
410589 U 8,90 €	GRIFF ›CLOUD BUFF‹ <ul style="list-style-type: none"> • anatomisch geformter Echtlederoptikgriff • handgenäht • geschlossenes Ende • 125 mm • auf M-Wave Eurolochkarte 	GRIP CLOUD BUFF‹ <ul style="list-style-type: none"> • anatomically shaped genuine leather design grip • handsewn • closed end • 125 mm • on M-Wave eurohole card 	
410124 U 31,90 € 	SCHRAUBGRIFF ›CLOUD ERGO MAX FIX BE‹ <ul style="list-style-type: none"> • Komfortgriff mit extra großer ergonomischer Auflagefläche, die dem Abknicken der Handgelenke vorbeugt • Zweikomponentengriff: harte Mischung innen und weiche Mischung außen für Komfort und Stoßabsorbierung • Microtech Noppen für noch besseren Halt • Aluminium-Klemme und integrierte 2-fache Schraubbefestigung für leichte (De-)Montage und besonders festem Halt am Lenker • mit Lenkerendstopfen • 140 mm • auf M-Wave Eurolochkarte 	SCREW-ON GRIP ›CLOUD ERGO MAX FIX BE‹ <ul style="list-style-type: none"> • comfort grip with especially wide ergonomic contact area, which prevents the wrists from deviating • 2-Component grip: hard inner mixture and soft outer mixture for comfort and shock absorbing • Microtech knobs for still better grip • aluminium clamp and integrated double screw attachment for easy (dis-)assembly and perfect grip at the handlebar • with handlebar plugs • 140 mm • on M-Wave eurohole card 	
410053 U 12,90 € 	SCHRAUBGRIFF ›CLOUD ERGOMAX FIX‹ <ul style="list-style-type: none"> • fest integrierte Schraubbefestigung für leichte (De-)Montage und festem Halt am Lenker • Komfortgriff mit ergonomischer Form, die dem Abknicken der Handgelenke vorbeugt • Zweikomponentengriff: harte Mischung innen und weiche Mischung außen für Komfort und Stoßabsorbierung • Microtech Noppen für noch besseren Halt • geschlossenes Ende • 138 mm • auf M-Wave Eurolochkarte 	SCREW-ON GRIP ›CLOUD ERGOMAX FIX‹ <ul style="list-style-type: none"> • firmly integrated screw attachment for easy (dis-)assembly and perfect grip at the handlebar • comfort grip with ergonomic shape, which prevents the wrists from deviating • 2-Component grip: hard inner mixture and soft outer mixture for comfort and shock absorbing • Microtech knobs for still better grip • closed end • 138 mm • on M-Wave eurohole card 	
410402 9,90 €	SCHRAUBGRIFF ›CLOUD ERGO FIX 2‹ <ul style="list-style-type: none"> • leichte (De-)Montage und fester Halt am Lenker durch doppelte Schraubbefestigung • anatomische Form • mit Lenkerendstopfen • 130 mm • auf M-Wave Eurolochkarte 	SCREW-ON GRIP ›CLOUD ERGO FIX 2‹ <ul style="list-style-type: none"> • easy (dis-)assembly and perfect grip at the handlebar through double screw attachment • anatomic shape • with handlebar plugs • 130 mm • on M-Wave eurohole card 	

ART.-NR. BESCHREIBUNG
UVP

DESCRIPTION

DOUBLE
D2
DENSITY

SCHRAUBGRIF
›CLOUD ERGO FIX‹

- **fest integrierte Schraubbefestigung** für leichte (De-)Montage und festem Halt am Lenker
- Komfortgriff mit **ergonomischer Form**, die dem Abknicken der Handgelenke vorbeugt
- **fließender Übergang** zur Klemme
- **Zweikomponentengriff D2**: harte Mischung innen und weiche Mischung außen für Komfort und Stoßabsorbierung
- **Microtech Noppen** für noch besseren Halt
- geschlossenes Ende
- auf M-Wave Eurolochkarte

410054 **132 / 132 mm**
U
11,90 €

410056 **132 / 92 mm**
U
13,90 €
92 mm mit **Innenklemmung**

SCREW-ON GRIP
›CLOUD ERGO FIX‹

- **firmly integrated screw attachment** for easy (dis-)assembly and perfect grip at the handlebar
- comfort grip with **ergonomic shape**, which prevents the wrists from deviating
- **smooth transition** to the clamp
- **2-Component grip D2**: hard inner mixture and soft outer mixture for comfort and shock absorbing
- **Microtech knobs** for still better grip
- closed end
- on M-Wave eurohole card

132 / 132 mm

132 / 92 mm
92 mm with **inner clamp**



SCHRAUBGRIF
›CLOUD BASE 2 FIX‹

- **integrierte Schraubbefestigung** für leichte (De-)Montage und festem Halt am Lenker
- Komfortgriff mit **ergonomischer Form**, die dem **Abknicken der Handgelenke** vorbeugt
- **Zweikomponentengriff**: harte Mischung innen für guten Halt auf dem Lenker und weiche Mischung außen für Komfort und Stoßabsorbierung
- geschlossenes Ende
- auf M-Wave Eurolochkarte

410121 **135 / 135 mm**
U

410122 **135 / 100 mm**
U
6,90 €

SCREW-ON GRIP
›CLOUD BASE 2 FIX‹

- **integrated screw attachment** for easy (dis-)assembly and perfect grip at the handlebar
- comfort grip with **ergonomic shape**, which prevents the **wrists from deviating**
- **2-Component grip**: hard inner mixture for good connection with handlebar and soft outer mixture for comfort and shock absorbing
- closed end
- on M-Wave eurohole card

135 / 135 mm

135 / 100 mm

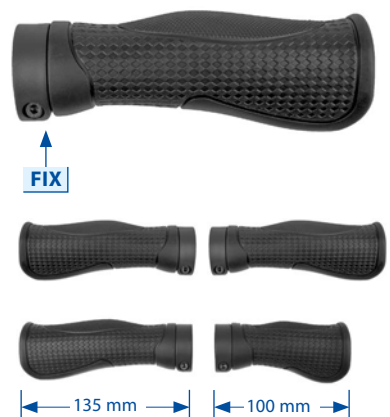

410401 **SCHRAUBGRIF**
›CLOUD SLICK FIX 2‹
9,90 €

- **Zweikomponenten-Schraubgriff**
- leichte (De-)Montage und **fester Halt** am Lenker durch **doppelte Aluminium-Schraubbefestigung**
- mit Lenkerendstopfen
- 130 mm
- auf M-Wave Eurolochkarte

SCREW-ON GRIP
›CLOUD SLICK FIX 2‹

- **2-Component screw-on grip**
- easy (dis-)assembly and **perfect grip** at the handlebar through **double aluminium screw attachment**
- with handlebar plugs
- 130 mm
- on M-Wave eurohole card

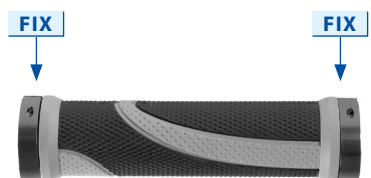

410403 **SCHRAUBGRIF**
›CLOUD SLICK FIX‹
6,90 €

- leichte (De-)Montage und **fester Halt** am Lenker durch **doppelte Schraubbefestigung**
- 130 mm
- mit Lenkerendstopfen
- auf M-Wave Eurolochkarte

SCREW-ON GRIP
›CLOUD SLICK FIX‹

- easy (dis-)assembly and **perfect grip** at the handlebar through **double screw attachment**
- 130 mm
- with handlebar plugs
- on M-Wave eurohole card



ART.-NR. UVP	BESCHREIBUNG	DESCRIPTION	
410123 6,90 €	SCHRAUBGRIFF ›CLOUD SLICK FIX 4‹ <ul style="list-style-type: none"> • ergonomische Form • leichte (De-)Montage und fester Halt am Lenker durch Schraubbefestigung • rutschfeste Gummigriffe • mit Lenkerendstopfen • 130 mm • auf M-Wave Eurolochkarte 	SCREW-ON GRIP ›CLOUD SLICK FIX 4‹ <ul style="list-style-type: none"> • ergonomic shape • easy (dis-)assembly and perfect grip at the handlebar through screw attachment • non-slip rubber grips • with handlebar plugs • 130 mm • on M-Wave eurohole card 	
410617 U 6,90 €	SCHRAUBGRIFF ›CLOUD SLICK FIX 6‹ <ul style="list-style-type: none"> • leichte (De-)Montage und fester Halt am Lenker durch Aluminium-Schraubbefestigung • Zweikomponentengriff: harte Mischung innen für guten Halt auf dem Lenker und weiche Mischung außen für Komfort und Stoßabsorbierung • mit Lenkerendstopfen • 130 mm • auf M-Wave Eurolochkarte 	SCREW-ON GRIP ›CLOUD SLICK FIX 6‹ <ul style="list-style-type: none"> • easy (dis-)assembly and perfect grip at the handlebar through aluminium screw attachment • 2-Component grip: hard inner mixture for good connection with handlebar and soft outer mixture for comfort and shock absorbing • with handlebar plugs • 130 mm • on M-Wave eurohole card 	
410316 9,90 €	SCHRAUBGRIFF ›CLOUD SLICK SHORT‹   <ul style="list-style-type: none"> • extra kurzer Griff: 115 mm • für kleine Hände • fest integrierte Kunststoff-Schraubbefestigung für leichte (De-)Montage und festem Halt am Lenker • Zweikomponentengriff: harte Mischung innen für guten Halt auf dem Lenker und weiche Mischung außen für Komfort und Stoßabsorbierung • geschlossenes Ende • besonders geeignet für E-Scooter • auf M-Wave Eurolochkarte 	SCREW-ON GRIP ›CLOUD SLICK SHORT‹ <ul style="list-style-type: none"> • extra short grip: 115 mm • for small hands • firmly integrated plastic screw attachment for easy (dis-)assembly and perfect grip at the handlebar • 2-Component grip: hard inner mixture for good connection with handlebar and soft outer mixture for comfort and shock absorbing • closed end • especially suitable for e-scooters • on M-Wave eurohole card 	
410404 6,90 €	SCHAUMSTOFF-SCHRAUBGRIFF ›CLOUD SLICK FIX LIGHT‹   <ul style="list-style-type: none"> • harte Mischung innen für guten Halt auf dem Lenker und superleichte, weiche Schaumstoffauflage außen für Komfort und Stoßabsorbierung • leichte (De-)Montage und fester Halt am Lenker durch doppelte Aluminium-Schraubbefestigung • nur 78 g/Paar • mit Lenkerendstopfen • 130 mm • auf M-Wave Eurolochkarte 	FOAM SCREW-ON GRIP ›CLOUD SLICK FIX LIGHT‹ <ul style="list-style-type: none"> • hard inner mixture for good connection with handlebar and super light soft foam outer mixture for comfort and shock absorbing • easy (dis-)assembly and perfect grip at the handlebar through double aluminium screw attachment • only 78 g/pair • with handlebar plugs • 130 mm • on M-Wave eurohole card 	
410701 U 12,90 €	GRIFF ›CLOUD SLICK FIX 5‹  <ul style="list-style-type: none"> • 100 % Silikon • rutschfest • sehr angenehme Haptik • stoßabsorbierend • asymmetrische Form ermöglicht individuelle Positionierung • langlebig, da UV-beständig und waschbar • temperaturunempfindlich • 130 mm • mit Lenkerendstopfen • auf M-Wave Eurolochkarte 	GRIP ›CLOUD SLICK FIX 5‹ <ul style="list-style-type: none"> • 100 % silicone • non-slip • very pleasant haptics • shock absorbing • asymmetric form enables individual positioning • long lasting because UV-resistant and washable • temperature insensitive • 130 mm • with handlebar plugs • on M-Wave eurohole card 	

Grips

ART.-NR. BESCHREIBUNG
UVP

DESCRIPTION

411010 GRIFF ›SLR‹

5,90 €



- sehr angenehme **Haptik**
- **atmungsaktiv** und **temperaturunempfindlich**
- stoßabsorbierend
- nur **30 g/Pair** durch **SLR (Super Light Rubber)**
- mit Lenkerendstopfen
- 130 mm
- auf M-Wave Eurolochkarte

GRIP ›SLR‹

- very pleasant **haptics**
- **breathable** and **temperature insensitive**
- shock absorbing
- only **30 g/pair** by **SLR (Super Light Rubber)**
- with handlebar plugs
- 130 mm
- on M-Wave eurohole card



410039 GRIFF ›CLOUD ERGO‹

6,90 €



- Komfortgriff mit **ergonomischer Form**, die dem **Abknicken der Handgelenke** vorbeugt
- **Zweikomponentengriff D2**: harte Mischung innen für guten Halt auf dem Lenker und weiche Mischung außen für Komfort und Stoßabsorbierung
- 132 mm
- auf M-Wave Eurolochkarte

GRIP ›CLOUD ERGO‹

- comfort grip with **ergonomic shape**, which prevents the **wrists** from **bending**
- **2-Component grip D2**: hard inner mixture for good connection with handlebar and soft outer mixture for comfort and shock absorbing
- 132 mm
- on M-Wave eurohole card



410531 GRIFF ›CLOUD BASE 3‹

4,90 €

- schwarz/grau
- Komfortgriff mit **ergonomischer Form**, die dem **Abknicken der Handgelenke** vorbeugt
- geschlossenes Ende
- 125 mm
- auf M-Wave Eurolochkarte

GRIP ›CLOUD BASE 3‹

- black/grey
- comfort grip with **ergonomic shape**, which prevents the **wrists** from **bending**
- closed end
- 125 mm
- on M-Wave eurohole card



410201 GRIFF ›FAT BOY‹

5,90 €

- **Zweikomponentengriff**
- schwarz/grau
- **weich** und **griffig**
- geschlossenes Ende
- 125 mm
- auf M-Wave Eurolochkarte

GRIP ›FAT BOY‹

- **2-Component grip**
- black/grey
- **soft** and **handy**
- closed end
- 125 mm
- on M-Wave eurohole card



↑
SOFT

410203 MTB GRIFF ›CLOUD BASE 1‹

4,90 €

- **Zweikomponentengriff**: harte Mischung innen für **guten Halt** auf dem Lenker und weiche Mischung außen für **Komfort, Stoßabsorbierung** und **zuverlässigen Halt**
- 130 mm
- auf M-Wave Eurolochkarte

MTB GRIP ›CLOUD BASE 1‹

- **2-Component grip**: hard inner mixture for **good connection** with the handlebar and soft outer mixture for **comfort, shock absorbing** and **perfect grip**
- 130 mm
- on M-Wave eurohole card



410233 ERGOGRIF ›CLOUD BASE 4‹

4,90 €

- Komfortgriff mit **ergonomischer Form**, die dem **Abknicken der Handgelenke** vorbeugt
- geschlossenes Ende
- 130 mm
- auf M-Wave Eurolochkarte

ERGO GRIP ›CLOUD BASE 4‹

- comfort grip with **ergonomic shape**, which prevents the **wrists** from **bending**
- closed end
- 130 mm
- on M-Wave eurohole card



ART.-NR. UVP	BESCHREIBUNG	DESCRIPTION	
	GRIFF ›CLOUD BASE 2‹ <ul style="list-style-type: none"> • Komfortgriff mit ergonomischer Form, die dem Abknicken der Handgelenke vorbeugt • geschlossenes Ende • auf M-Wave Eurolochkarte 	GRIP ›CLOUD BASE 2‹ <ul style="list-style-type: none"> • comfort grip with ergonomic shape, which prevents the wrists from bending • closed end • on M-Wave eurohole card 	
410524 U	schwarz, 130 / 130 mm	black, 130 / 130 mm	
410539 U	schwarz, 130 / 95 mm	black, 130 / 95 mm	
410522 U 4,90 €	braun, 130 / 130 mm	brown, 130 / 130 mm	
	GRIFF ›ERGOGEL‹ <ul style="list-style-type: none"> • Komfortgriff mit ergonomischer Form, die dem Abknicken der Handgelenke vorbeugt • Negativprofil gibt bei Nässe Halt • mit Lenkerendstopfen 	GRIP ›ERGOGEL‹ <ul style="list-style-type: none"> • comfort grip with ergonomic shape, which prevents the wrists from bending • negative profile avoids additional slipping at wet conditions • with handlebar plugs 	
• 410527	131 / 131 mm, paarweise im Polybeutel	131 / 131 mm, 1 pair in PE bag	
410529	131 / 92 mm, auf M-Wave Eurolochkarte	131 / 92 mm, on M-Wave eurohole card	
4,90 €			
410212 U 3,90 €	GRIFF ›CLOUD TIRE 1‹ <ul style="list-style-type: none"> • schwarz • griffige Feinnoppen-Struktur gibt guten Halt • geschlossenes Ende • 125 mm • auf M-Wave Eurolochkarte 	GRIP ›CLOUD TIRE 1‹ <ul style="list-style-type: none"> • black • non-slip fine knob structure gives good grip • closed end • 125 mm • on M-Wave eurohole card 	
410007	GRIFF ›Grip Shift 102‹, 102 mm	GRIP ›Grip Shift 102‹, 102 mm	
410018 3,90 €	›Grip Shift 90‹, 90 mm	›Grip Shift 90‹, 90 mm	
410213 U	GRIFF ›CLOUD SLICK‹ <ul style="list-style-type: none"> • schwarz • geschlossenes Ende • auf M-Wave Eurolochkarte 130 / 85 mm	GRIP ›CLOUD SLICK‹ <ul style="list-style-type: none"> • black • closed end • on M-Wave eurohole card 130 / 85 mm	
410214	130 mm	130 mm	
3,90 €			
410241 U 2,90 €	GRIFF ›CLOUD TIRE 2‹ <ul style="list-style-type: none"> • griffige Struktur gibt guten Halt • geschlossenes Ende • 120 mm • auf M-Wave Eurolochkarte 	GRIP ›CLOUD TIRE 2‹ <ul style="list-style-type: none"> • non-slip structure gives good grip • closed end • 120 mm • on M-Wave eurohole card 	

ART.-NR. UVP **BESCHREIBUNG**

DESCRIPTION

410555 GRIFF ›HEXFOAM‹

5,90 €



- **hexagonale** Form
- nur **44 g**/Paar
- aus leichtem **High-Density-Schaum**
- mit Lenkerendstopfen
- 125 mm
- auf M-Wave Eurolochkarte

GRIP ›HEXFOAM‹

- **hexagonal** shape
- only **44 g**/pair
- light **high density foam**
- with handlebar plugs
- 125 mm
- on M-Wave eurohole card

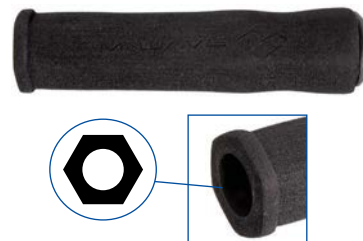

GLOCKE ›BELLA TRILL‹

- **schnelle Montage**
- mit nur einer **M3** Schraube
- Ø 53 mm
- **Aluminium**

auf M-Wave Eurolochkarte

420192
U

- für **Rechtsmontage**
- schwarz
- besonders geeignet für **E-Bikes** mit Display auf der linken Seite

• für **Linksmontage**

420191
U

schwarz

420193
U

silber

420152
U

240/12
weiß

420153
U

rot

420154
U

blau

420155
U

grün

420157
U

orange

420158
U

pink

2,90 €

BELL ›BELLA TRILL‹

- **fast assembling**
- with only one **M3** screw
- Ø 53 mm
- **aluminium**

on M-Wave eurohole card

- for **right side mounting**
- black
- especially suitable for **e-bikes** with display on the left side

• for **left side mounting**

black

silver

white

red

blue

green

orange

pink

RIGHT SIDE MOUNTING



GLOCKE ›BELLA 3D‹

- Stahl
- mit verschiedenen **3D-Motiven**
- Kunststoffunterteil mit 2 Schrauben

auf M-Wave Eurolochkarte

420138

Wassermelone

420139

Orange

420125

Black fancy

420124
U

White fancy

420121
U

I love my bike

420123
U

Smile

BELL ›BELLA 3D‹

- steel
- with several **3D pictures**
- plastic base with 2 screws

on M-Wave eurohole card

Watermelon

Orange

Black fancy

White fancy

I love my bike

Smile



420119
U **Kinderglocken, farbig sortiert, 6 Stück in neutralem Karton**

children bells, coloured assorted, 6 pieces in neutral box



Montageverpackung

OEM

420197

Horse

Horse

420198

Soccer

Soccer

2,90 €



ART.-NR. UVP	BESCHREIBUNG	DESCRIPTION	
	KINDERGLOCKENSORTIMENT	CHILDREN BELLS ASSORTMENT	
	<ul style="list-style-type: none"> • Stahl • farbig sortiert • mit verschiedenen Kindermotiven 	<ul style="list-style-type: none"> • steel • assorted colours • with different designs for kids 	
420190 U 2,90 €	12 Stück im M-Wave Thekendisplay	12 pcs in M-Wave sales display	
			



KUPFERGLOCKE ›BELLA C-YELL‹

- **sehr lauter und langanhaltender Klang (100 dB)**
- Ø 30 mm
- inkl. 3M Einlegegummi
- in M-Wave Eurolochbox

COPPER BELL ›BELLA C-YELL‹

- **very loud and long lasting sound (100 dB)**
- Ø 30 mm
- incl. 3M rubber inlay
- in M-Wave eurohole box



- 420451**
- schwarz
 - gemäß **DIN 33946 für E-Bikes zugelassen**

- black
- **approved for e-bikes according to DIN 33946**

420450
U
11,90 €

silber

silver



MESSINGGLOCKE ›BELLA DING-DONG‹

- Ø 33 mm
- **sehr lauter und langanhaltender Klang**
- auf M-Wave Eurolochkarte

BRASS BELL ›BELLA DING-DONG‹

- Ø 33 mm
- **very loud and long lasting sound**
- on M-Wave eurohole card



420053

messing

brass

420099

silber

silver

420098
U
4,90 €

schwarz

black



420061
U
6,90 €

MESSINGGLOCKE ›BELLA SUPER MINI‹

- XS-Klingel, Ø 23 mm
- **sehr lauter und langanhaltender Klang**
- Klingel vom Halter **abnehmbar**
- verstellbarer **Universalhalter** von Ø 22 - 31,8 mm
- schwarz
- auf M-Wave Eurolochkarte

BRASS BELL ›BELLA SUPER MINI‹

- XS bell, Ø 23 mm
- **very loud and long lasting sound**
- bellbody **detachable**
- adjustable **universal bracket** from Ø 22 - 31.8 mm
- black
- on M-Wave eurohole card



ART.-NR. UVP **BESCHREIBUNG**

DESCRIPTION

MINIGLOCKE ›SOCCER‹

- **Aluminium**
- mit „Schuh“-Federklöppel
- im **Länderflaggen-Design**
- ca. Ø 38 mm
- auf M-Wave Eurolochkarte

- 420201** Deutschland
- 420202** England
- 420202** Österreich
- 420202** Polen
- 420202** Türkei

3,90 €

MINI BELL ›SOCCER‹

- **aluminium**
- with "shoe" spring lever
- in **national flag design**
- approx. Ø 38 mm
- on M-Wave eurohole card

- Germany
- England
- Austria
- Poland
- Turkey



420063 MINIGLOCKE ›BELLA DOME‹

3,90 €



- ca. Ø 34 mm
- lauter und langanhaltender Klang
- **360° drehbar**
- **universelle, schnelle und werkzeuglose** Montage am Lenker, Vorbau, Gabelschaft, ...
- mit **zusätzlichem Befestigungsring** für unterschiedliche Ø
- auf M-Wave Eurolochkarte

MINI BELL ›BELLA DOME‹

- approx. Ø 34 mm
- loud and long lasting sound
- **360° turnable**
- **universal, quick and toolless** mounting at the handlebar, stem, steerer, ...
- with **additional mounting ring** for different Ø
- on M-Wave eurohole card



420030 U MINIGLOCKENSORTIMENT

2,90 €

- **bedruckt**
- mit verschiedenen Motiven
- im M-Wave Thekendisplay

MINI BELLS ASSORTMENT

- **with imprints**
- in different designs
- in M-Wave sales display



MINIGLOCKE ›BELLA DESIGN‹

- **Aluminium**
- ca. Ø 36 mm
- sehr **lauter** und **langanhaltender** Klang
- Klöppel 360° drehbar
- mit metrischer Schraube
- auf M-Wave Eurolochkarte

- 420067** gold
- 420066** schwarz
- 420142** weiß
- 420143** rot
- 420144** blau
- 420145** grün
- 420147** orange
- 420148** pink

1,90 €

MINI BELL ›BELLA DESIGN‹

- **aluminium**
- approx. Ø 36 mm
- very **loud** and **long lasting** sound
- lever 360° turnable
- with metric screw
- on M-Wave eurohole card

- gold
- black
- white
- red
- blue
- green
- orange
- pink

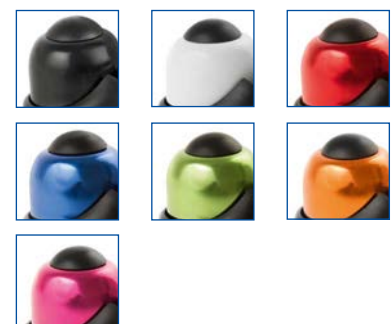

ART.-NR. UVP **BESCHREIBUNG** **DESCRIPTION**

MINIGLOCKE

- **Stahl**
- mit **metrischer Schraube**
- Klöppel 360° drehbar

420026
U
1,90 €

- › **Bella Mini-Black** ‹
- schwarz
 - 20 Stück im **M-Wave Thekendisplay**

MINI BELL

- **steel**
- with **metric screw**
- lever 360° turnable

- › **Bella Mini-Black** ‹
- black
 - 20 pieces in **M-Wave sales display**



420025
1,90 €

- **Pasteltöne**, farbig sortiert
- weißes Unterteil
- 20 Stk. im **M-Wave Thekendisplay**

- **pastel shades**, assorted colours
- white bottom
- 20 pcs. in **M-Wave sales display**



GLOCKE ›MAXI DING-DONG‹

- **Ø 80 mm**
- auf M-Wave Eurolochkarte

420324
14,90 €

- Messing**, sehr **lauter** und lang **an-**
haltender Klang

BELL ›MAXI DING-DONG‹

- **Ø 80 mm**
- on M-Wave eurohole card

- brass**, very **loud** and long **lasting** sound



Stahl

420322
U
10,90 €

- Fluo, mit **fluoreszierenden** Punkten,
ca. 1 Std. Leuchtdauer

steel

- Fluo, with **fluorescent** dots,
approx. 1 h glowing time



420333
U

- A smile is the best makeup

- A smile is the best makeup

420330

- I Love My Bike

- I Love My Bike

420331

- Heartbreaker

- Heartbreaker

420325
U

- Apps

- Apps

420306

- Newspaper

- Newspaper

420307

- Umbrella

- Umbrella

420308
U

- Sunflower

- Sunflower

420320
U

- Ladybird

- Ladybird

420311
U
7,90 €

- Smile

- Smile



420313
7,90 €

- sortiert, im M-Wave-Thekendisplay
(8 Stück),
Sortierung wird regelmäßig aktualisiert.

- assorted, in M-Wave sales display (8 pcs),
sorting will be updated regularly.



ART.-NR. UVP **BESCHREIBUNG**

DESCRIPTION

420270 ELEKTRISCHE KLINGEL

12,90 €



- Lautstärke **120 db**
- **werkzeuglose Montage**
- passend für Lenker mit **Ø 22,2 - 31,8 mm**
- **wasserfest**
- inkl. Batterie (Art. 640824)
- in M-Wave Blisterverpackung
- 20 Stück im **M-Wave Thekendisplay**

ELECTRO BELL

- loudness **120 db**
- **toolless mounting**
- suitable for handlebars with **Ø 22.2 - 31.8 mm**
- **waterproof**
- incl. battery (art. 640824)
- in M-Wave blister packaging
- 20 pcs in **M-Wave sales display**



Verkauf und Nutzung im Geltungsbereich der StVZO (Deutschland) unzulässig (Abgabe nur an außerdeutsche Kunden).

430744 FAHRRADSTÄNDER ›STRONG R III‹

12,90 €

- zur Montage am Hinterbau
- **Aluminium**
- Länge werkzeuglos **verstellbar** für 26" - 29"
- **universell einstellbar für fast alle Hinterbauwinkel, Rohrdurchmesser und Scheibenbremsenden**
- mit **Gummifuß**
- auf M-Wave Eurolochkarte

SIDE STAND ›STRONG R III‹

- for rear stay
- **aluminium**
- length **adjustable** without tools for 26" - 29"
- **universally adjustable for almost all rear stay angles, tube diameters and disc brake ends**
- with **rubber foot**
- on M-Wave eurohole card

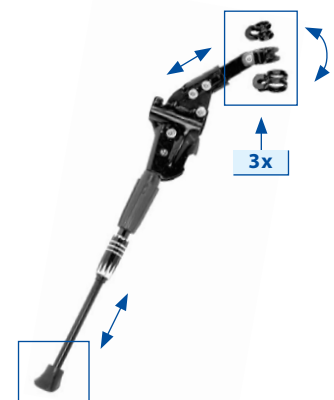

FAHRRADSTÄNDER

- **Aluminium**
- extra robuste Ausführung
- **verstellbar** von 24" - 29"
- besonders **für E-Bikes geeignet**
- mit **stabilem Sicherheitsfuß**
- inkl. Montagmaterial
- für Montage an der Kettenstrebe

SIDE STAND

- **aluminium**
- extra robust design
- **adjustable** from 24" - 29"
- especially **suitable for e-bikes**
- with **stable safety foot**
- incl. mounting material
- for assembling at the chain stay



430849 Montageverpackung

U

OEM

430850 auf M-Wave Eurolochkarte

on M-Wave eurohole card

18,90 €

›COLUMN-E1‹

- **passend** für Lochabstand **18 mm**
- mit Verdrehschutz-Nut
- mit 2x M6 **Niro**-Befestigungsschrauben und Muttern

›COLUMN-E1‹

- **suitable** for hole distance **18 mm**
- anti-rotation slot
- with 2x M6 **stainless steel** mounting screws and nuts

430853 Montageverpackung

U

OEM



430854 auf M-Wave Eurolochkarte



on M-Wave eurohole card



17,90 €

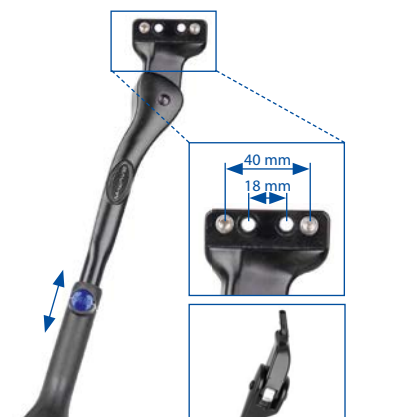



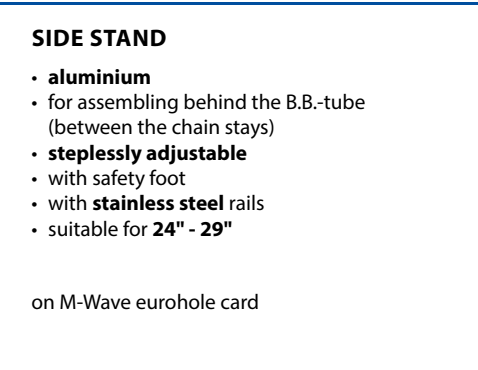

ART.-NR. UVP	BESCHREIBUNG	DESCRIPTION
-----------------	--------------	-------------

<p>• 430925 U 14,90 €</p>  	<p>FAHRRADSTÄNDER</p> <ul style="list-style-type: none"> • stabile Ausführung für E-Bikes, ... • zur Montage an der Kettenstrebe, universell passend für Lochabstand 40 und 18 mm • mit 2x M6 Nirosta Beilagscheiben und Muttern • Aluminium • werkzeuglos verstellbar • für 24" - 29" • mit Sicherheitsfuß • inkl. Montagematerial • Montageverpackung 	<p>SIDE STAND</p> <ul style="list-style-type: none"> • robust design for e-bikes, ... • for mounting at the chain stay, universally suitable for hole distance 40 and 18 mm • with 2x M6 stainless steel washers and nuts • aluminium • adjustable without tools • for 24" - 29" • with safety foot • incl. mounting material • OEM 	
--	--	--	---

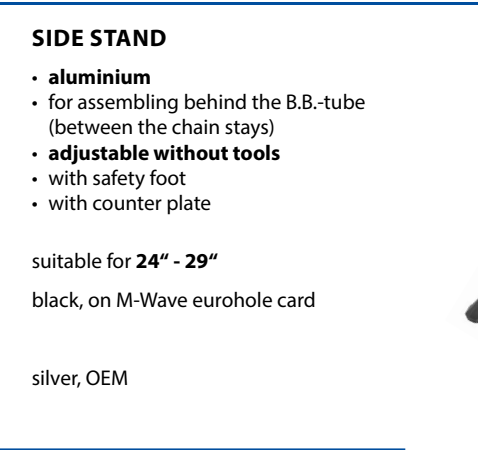
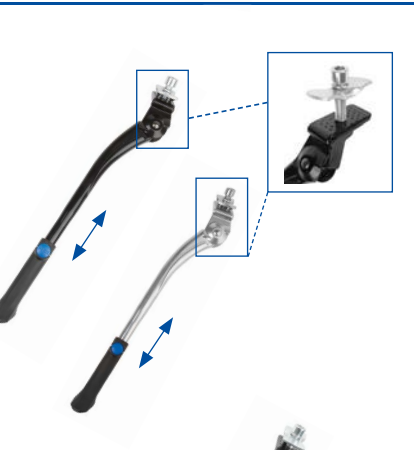
<p></p>	<p>FAHRRADSTÄNDER ›COLUMN-C1‹</p> <ul style="list-style-type: none"> • Aluminium • verstellbar von 24" - 29" • extra robuste Ausführung • besonders für E-Bikes geeignet • mit stabilem Sicherheitsfuß • für Montage in der Mitte (hinter dem Tretlagergehäuse) • mit Gegenplatte <p>430734 U Montageverpackung</p> <p>430736 auf M-Wave Eurolochkarte 16,90 €</p>	<p>SIDE STAND ›COLUMN-C1‹</p> <ul style="list-style-type: none"> • aluminium • adjustable from 24" - 29" • extra robust design • especially suitable for e-bikes • with stable safety foot • for assembling behind the B.B. tube (between the chain stays) • with counter plate <p>OEM</p> <p>on M-Wave eurohole card</p>	
--	--	---	--

<p>430851 FAHRRADSTÄNDER</p> <p>8,90 €</p> <ul style="list-style-type: none"> • Aluminium • für Montage in der Mitte (hinter dem Tretlagergehäuse) • stufenlos verstellbar • mit Sicherheitsfuß • mit Edelstahlstreben • passend für 24" - 29" <p>auf M-Wave Eurolochkarte</p>	<p>SIDE STAND</p> <ul style="list-style-type: none"> • aluminium • for assembling behind the B.B.-tube (between the chain stays) • steplessly adjustable • with safety foot • with stainless steel rails • suitable for 24" - 29" <p>on M-Wave eurohole card</p>	<p>STAINLESS</p> 	
--	---	--	---

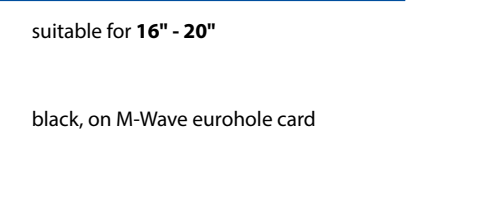
<p></p> <p>FAHRRADSTÄNDER</p> <ul style="list-style-type: none"> • Aluminium • für Montage in der Mitte (hinter dem Tretlagergehäuse) • werkzeuglos verstellbar • mit Sicherheitsfuß • mit Gegenplatte <p>passend für 24" - 29"</p> <p>430714 schwarz, auf M-Wave Eurolochkarte</p> <p>• 430716 silber, Montageverpackung 8,90 €</p>	<p>SIDE STAND</p> <ul style="list-style-type: none"> • aluminium • for assembling behind the B.B.-tube (between the chain stays) • adjustable without tools • with safety foot • with counter plate <p>suitable for 24" - 29"</p> <p>black, on M-Wave eurohole card</p> <p>silver, OEM</p>		
--	---	--	---

<p></p> <p>passend für 16" - 20"</p> <p>430712 schwarz, auf M-Wave Eurolochkarte 8,90 €</p>	<p>suitable for 16" - 20"</p> <p>black, on M-Wave eurohole card</p>		
--	--	--	---

ART.-NR. BESCHREIBUNG
UVP

DESCRIPTION

430217 FAHRRAD-WANDHALTER
›COLLECTOR‹
U
49,90 €

BICYCLE DEPOT WALL HANGER
›COLLECTOR‹



- zugelassen auch für **E-Bikes** bis **40 kg**
- für Fahrräder, Fahrradträger, Ski, ...
- mit **Helm-, ... -ablage**
- besonders **stabil** und **belastbar**
- 2 Haltebügel mit Kunststoff-**Schutzüberzug**
- **hochklappbar**
- mit Befestigungsschrauben und Dübeln
- mit M-Wave Eurolochkarte

- also approved for **e-bikes** up to **40 kg**
- for bikes, bike carriers, ski, ...
- with **helmet, ... depot**
- very **solid** and **loadable**
- two arms with plastic **protection cover**
- **foldable**
- with screws and plugs
- with M-Wave eurohole card

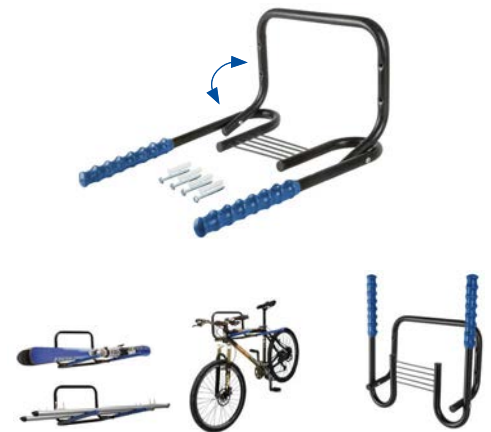

430215 FAHRRAD-WANDHALTER
›COLLECTOR HD‹
U
34,90 €

BICYCLE DEPOT WALL HANGER
›COLLECTOR HD‹



- stabiler Wandhalter
- **zugelassen für bis zu 2 E-Bikes** mit insgesamt bis zu **70 kg**
- Haltebügel mit Kunststoffschutzüberzug
- für Fahrräder, Fahrradträger, Ski, ...
- mit Helm-, ... -Ablage
- **hochklappbar**
- inkl. Montagematerial
- mit M-Wave Banderole

- stable wall hanger
- **approved for up to 2 e-bikes** with a total of up to **70 kg**
- hooks with plastic protection cover
- for bikes, bike carriers, ski, ...
- with helmet, ... depot
- **foldable**
- incl. mounting material
- with M-Wave banderole

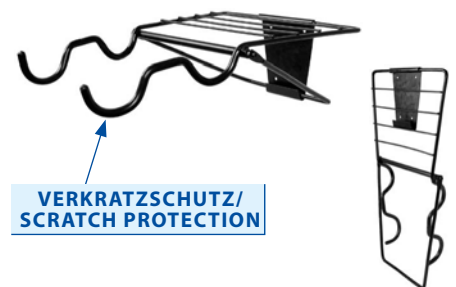

VERKRATZSCHUTZ/
SCRATCH PROTECTION

430288 VERTIKALER UND HORIZONTALER
FAHRRADHALTER ›RAIMUND‹
69,90 €

VERTICAL AND HORIZONTAL
BICYCLE STAND ›RAIMUND‹



- **2 in 1**
- sehr **einfache Handhabung**
- **platzsparende** und **sichere** Unterbringung
- für **Fahrräder aller Größen 12" - 29"**
- für Reifenbreiten bis **2,50"**
- werkzeuglose Höhenverstellung
- mit **Non-Slip** Füßen
- Montageverpackung

- **2 in 1**
- very **easy handling**
- **space saving** and **safe** storage
- suitable for **all bicycles 12" - 29"**
- for tire widths up to **2.50"**
- tollless height adjustment
- with **non-slip** feet
- OEM



2 IN 1 VERTICAL
HORIZONTAL

430295 FAHRRADHALTER
›EASYSTAND PREMIUM‹
U
44,90 €

BICYCLE STAND
›EASYSTAND PREMIUM‹



- **hochwertige Ausführung** aus **Edelstahl**
- für **Fahrräder aller Größen 12" - 29"**
- Reifenbreite bis **2,50"**
- kein Anheben des Rades notwendig, **einfach hinein-/herausrollen**
- aus stabilem Rundrohr
- **Non-Slip** Füße
- mit M-Wave Banderole

- **high-quality** made of **stainless steel**
- for **bicycles of all sizes 12" - 29"**
- max. tire width up to **2.50"**
- no lifting of the bike necessary, **just roll in and out**
- solid round tubes
- **non-slip** feet
- with M-Wave banderole

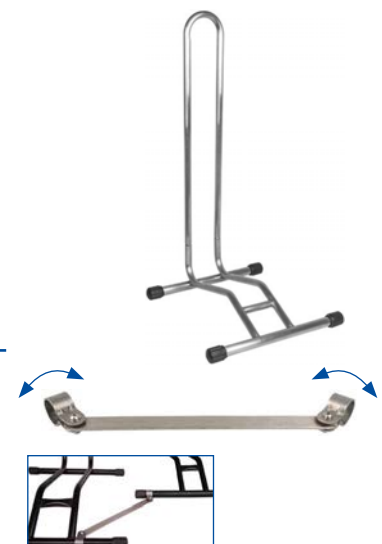



430298 VERBINDUNGSADAPTER
U
7,90 €
Machen Sie Einzelständer zum **variablen Mehrfachsystem!**



CONNECTOR
Make basic stand to a **variable multiple system!**

- **hochwertige Ausführung** aus **Edelstahl**
- universell passend
- auf M-Wave Eurolochkarte

- **high-quality** made of **stainless steel**
- universally suitable
- on M-Wave eurohole card





ART.-NR. UVP	BESCHREIBUNG	DESCRIPTION	
430287 34,90 €	AUFBEWAHRUNGS- UND MONTAGESTÄNDER ›EASYSTAND HOOK‹ <ul style="list-style-type: none"> • 2 Haken mit Gummischutzüberzug für Fahrräder aller Größen 12" - 29" • aus stabilem Rundrohr • mit Schaumstoffbreitenadapter für Reifenbreiten bis 2,50" • mit Non-Slip Füßen • im M-Wave Einzelkarton 	STORAGE AND MOUNTING STAND ›EASYSTAND HOOK‹ <ul style="list-style-type: none"> • 2 hooks with rubber protection cover • for bicycle of all sizes 12" - 29" • solid round tubes • with foam width adapter for tire widths up to 2.50" • with non-slip feet • in M-Wave box 	  

<div style="border: 1px solid black; border-radius: 50%; width: 40px; height: 40px; display: flex; align-items: center; justify-content: center; margin-bottom: 5px;"> 12" - 29" </div> FAHRRADHALTER ›EASYSTAND‹ <ul style="list-style-type: none"> • für Fahrräder aller Größen 12" - 29" • Reifenbreite bis 2,50" • kein Anheben des Rades notwendig, einfach hinein-/herausrollen • mit Breitenadapter • aus stabilem Rundrohr • mit Schaumstoffschutz • Non-Slip Füße 	BICYCLE STAND ›EASYSTAND‹ <ul style="list-style-type: none"> • for bicycles of all sizes 12" - 29" • max. tire width up to 2.50" • no lifting of the bike necessary, just roll in and out • with width adapter • solid round tubes • with foam cover • non-slip feet 	 
430285 U schwarz, im M-Wave Einzelkarton Montageverpackung	black, in M-Wave box OEM	
430280 schwarz	black	
430282 silber 36,90 €	silver	

430290 U 27,90 €	• für Fahrräder von 16" - 20" geeignet • schwarz, Montageverpackung	• suitable for bicycles from 16" - 20" • black, OEM	
----------------------------	---	---	---

430291 36,90 €	FAHRRADHALTER ›EASYSTAND PLUS‹ <ul style="list-style-type: none"> • Reifenbreite von 2,50" - 3,25" • für Fahrräder aller Größen 12" - 29" • kein Anheben des Rades notwendig, einfach hinein-/herausrollen • aus stabilem Rundrohr • mit Schaumstoffschutz • Non-Slip Füße • schwarz • Montageverpackung 	BICYCLE STAND ›EASYSTAND PLUS‹ <ul style="list-style-type: none"> • tire width 2.50" - 3.25" • for bicycles of all sizes 12" - 29" • no lifting of the bike necessary, just roll in and out • solid round tubes • with foam cover • non-slip feet • black • OEM 	
--------------------------	--	---	--

430249 46,90 €	FAHRRADHALTER <ul style="list-style-type: none"> • platzsparend da klappbar • für 20" - 29" geeignet • kein Anheben des Rades notwendig, einfach hinein-/herausrollen • sicherer Halt des Rades durch 3-Punkt-Halterung • für verschiedene Reifenbreiten optimiert 	BICYCLE STAND <ul style="list-style-type: none"> • space saving because foldable • suitable for 20" - 29" • no lifting of the bike necessary, just roll in and out • secure stand of the bicycle through 3-point fitting • optimized for different tire widths 	 
--------------------------	---	--	---

MTB
26"-29"

ROAD
700x
20-45C

KIDS

ART.-NR. **BESCHREIBUNG**
UVP

DESCRIPTION

439903 **FAHRRADSTÄNDER**
›CHOPSTAND APART‹
19,90 €



- **werkzeug- und stufenlos höhenverstellbar um 150 mm**
- **platzsparend zerlegbar**
- mit **Kratzschutz**
- für **12" - 29"** geeignet
- für Verwendung an der Vorder- oder Hinterradachse
- für fast alle Räder mit **Scheibenbremsen geeignet**
- in M-Wave Eurolochbox

BIKE STAND
›CHOPSTAND APART‹

- **150 mm stepless height adjustment without tools**
- **space savingly demountable**
- with **scratch protection**
- suitable for **12" - 29"**
- for using at the front or rear axle
- suitable for almost every bike with **disc brakes**
- in M-Wave eurohole box



430252 **AUSSTELLUNGSSTÄNDER**
22,90 €

- mit **Kratzschutz**
- für **12" - 29"** geeignet
- für Verwendung an der **Vorder- oder Hinterradachse**
- für fast alle Räder mit **Scheibenbremsen geeignet**

DISPLAY STAND

- with **scratch protection**
- suitable for **12" - 29"**
- for using at the **front or rear** axle
- usable for almost every bike with **disc brakes**



430098 **FAHRRADLIFT**
›BIKE LIFT STRONG‹
40,90 €/set



- mit **Gummi überzogenen** Befestigungshaken zum Schutz vor Verkratzen des Fahrrads
- **stabiles Rundseil** Ø 6,5 mm
- bis zu 4 m Höhe
- geeignet bis **57 kg, daher besonders für E-Bikes geeignet**
- im M-Wave Einzelkarton

BICYCLE LIFT
›BIKE LIFT STRONG‹

- hooks with **plastic covers** for scratch protection
- **stable round rope** Ø 6.5 mm
- up to 4 m ceiling height
- usable up to **57 kg, so especially made for E-bikes**
- in M-Wave box



439992 **STÜTZRÄDER**
13,90 €

- nach **ISO 8098**
- für Kinder-Fahrräder
- passend für **12" - 20"**
- mit Zusatzstrebe als **Drehschutz**
- in M-Wave Blisterverpackung

STABILIZER

- according to **ISO 8098**
- for children bikes
- suitable for **12" - 20"**
- with **anti-turn** bracket
- in M-Wave blister packaging

according to ISO 8098



ART.-NR. UVP **BESCHREIBUNG**

DESCRIPTION

431570 WEIDENKORB ›BA-FW CLIP STEM‹
 U
 72,90 €



- aus echtem **Weidengeflecht**
- handgemacht
- Montage vorne mit **Clip-on**-Halter für Vorbau oder Steuersatzrohr
- ca. 38 x 28 x 27 cm
- mit M-Wave Karte

WICKER BASKET ›BA-FW CLIP STEM‹

- made of genuine **wicker network**
- handmade
- mounting at the front with **clip-on** bracket for stem or head set tube
- approx. 38 x 28 x 27cm
- with M-Wave card



431571 ERSATZ-/ZWEIT-CLIP-ON-HALTER
 U
 13,90 €

universell passend für Art. 431570 und viele andere Körbe

REPLACEMENT/SECOND CLIP-ON BRACKET

universally suitable for art. 431570 and many other baskets



431572 WEIDENKORB ›BA-FW CLIP BAR‹
 U
 66,90 €



- aus echtem **Weidengeflecht**
- handgemacht
- inkl. **Clip-on**-Halter für Lenkermontage (Ø 22,2 - 31,8 mm)
- ca. 38 x 28 x 26 cm
- Ersatz-/ Zweit-Clip-on-Halter: Art. 431523
- mit M-Wave Karte

WICKER BASKET ›BA-FW CLIP BAR‹

- made of genuine **wicker network**
- handmade
- incl. **clip-on** bracket for mounting at handlebar (Ø 22.2 - 31.8 mm)
- approx. 38 x 28 x 26 cm
- replacement/ second clip-on bracket: art. 431523
- with M-Wave card



431650 WEIDENKORB ›UNIVERSAL‹
 U
 72,90 €

- aus echtem **Weidengeflecht**
- handgemacht
- mit Deckel
- z. B. für Vorderrad-Gepäckträger Art. 440455
- ca. 40 x 33 x 25,5 cm
- mit M-Wave Karte

WICKER BASKET ›UNIVERSAL‹

- made of genuine **wicker network**
- handmade
- with lid
- e. g. for front wheel carrier art. 440455
- approx. 40 x 33 x 25.5 cm
- with M-Wave card

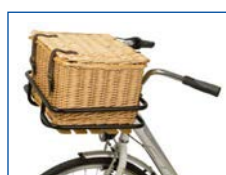

ART.-NR. BESCHREIBUNG
UVP

DESCRIPTION

431605 WEIDENKORB ›CARRIER TOP‹

104,90 €
U



- aus echtem **Weidengeflecht**
- handgemacht
- mit "Deckel" aus Stahldraht
- **werkzeuglose Befestigung** am Gepäckträger
- auch für Haustiere geeignet
- ca. 43,5 x 31 x 22/16,5 cm
- mit M-Wave Karte

WICKER BASKET ›CARRIER TOP‹

- made of genuine **wicker network**
- handmade
- with steel wire „lid“
- **toolless mounting** on carrier
- also for pets
- approx. 43.5 x 31 x 22/16.5 cm
- with M-Wave card



431604 WEIDENKORB ›BA PET‹

114,90 €
U



- aus echtem **Weidengeflecht**
- handgemacht
- mit "Deckel" aus Stahldraht
- Befestigung mit **Clip-on-Halter am Sitzrohr oder Vorbau**
- auch für Haustiere geeignet
- ca. 43 x 29,5 x 22/14 cm
- mit M-Wave Karte

WICKER BASKET ›BA PET‹

- made of genuine **wicker network**
- handmade
- with steel wire „lid“
- mounting with **clip-on bracket on seat tube or stem**
- also for pets
- approx. 43 x 29.5 x 22/14 cm
- with M-Wave card



431680 SEEGRASKORB ›OCEAN F‹

44,90 €

- aus **Seegras geflochten**
- handgemacht
- verstärkte Haupt- und Nebenstreben
- kunststoffummantelter, ergonomischer Tragegriff
- ca. 35 x 25 x 26/22 cm
- mit Clip-on-Lenkerhalter (Art. 431523)
- mit M-Wave Karte

SEAGRASS BASKET ›OCEAN F‹

- made of **seagrass woven**
- handmade
- reinforced main and auxiliary bars
- plastic covered ergonomic handle
- approx. 35 x 25 x 26/22 cm
- with clip-on handlebar bracket (art. 431523)
- with M-Wave card



431686 SEEGRASKORB ›OCEAN R‹

33,90 €

- aus **Seegras geflochten**
- handgemacht
- verstärkte Haupt- und Nebenstreben
- kunststoffummantelter, ergonomischer Tragegriff
- ca. 41 x 29,5 x 17/14,5 cm
- mit integriertem **Gepäckträgerhalter**
- mit M-Wave Karte

SEAGRASS BASKET ›OCEAN R‹

- made of **seagrass woven**
- handmade
- reinforced main and auxiliary bars
- plastic covered ergonomic handle
- approx. 41 x 29.5 x 17/14.5 cm
- with integrated **carrier bracket**
- with M-Wave card



ART.-NR. BESCHREIBUNG
UVP

DESCRIPTION

431515
U
24,90 €



DRAHTKORB ›BA-F CLIP BAR‹

- besonders **stabile** und **hochwertige Ausführung**
- aus feinmaschigem Stahlgeflecht
- **verstärkte** Haupt- und Nebenstreben
- **kunststoffummantelter, ergonomischer Tragegriff**
- ca. 35 x 25 x 25/22 cm
- mit **Clip-on-Halter** (Art. 122709) für Montage am Lenker (**Ø 22,2 mm - Ø 31,8 mm**) und Abstützung am Vorbau
- **Neigungswinkel einstellbar**
- mit M-Wave Logoplatte
- mit M-Wave Karte

WIRE BASKET ›BA-F CLIP BAR‹

- very **firm** and **high quality design**
- fine meshed steel net
- **reinforced** main and auxiliary bars
- **plastic covered, ergonomic handle**
- approx. 35 x 25 x 25/22 cm
- with **clip-on bracket** (art. 122709) for assembling on handlebar (**Ø 22.2 mm - Ø 31.8 mm**) and brace support on the stem
- **adjustable angle**
- with M-Wave logo plate
- with M-Wave card



DRAHTKORB

- besonders **stabile** und **hochwertige Ausführung**
- aus feinmaschigem Stahlgeflecht
- **verstärkte** Haupt- und Nebenstreben
- **kunststoffummantelter, ergonomischer Tragegriff**
- mit stabilem Vorbau-**Clip-on-Halter** für 1" und 1½" Vorbauten
- mit M-Wave Logoplatte
- mit M-Wave Karte

WIRE BASKET

- very **firm** and **high quality design**
- fine meshed steel net
- **reinforced** main and auxiliary bars
- **plastic covered, ergonomic handle**
- with firm stem **clip-on bracket** for 1" and 1½" stems
- with M-Wave logo plate
- with M-Wave card



431525
U
20,90 €

›BA-F CLIP STEM‹
ca. 33,5 x 25,5 x 25,5/22 cm (B x L x H)

›BA-F CLIP STEM‹
approx. 33.5 x 25.5 x 25.5/22 cm (W x L x H)

431526
U
19,90 €

›BA-F CLIP STEM LONG‹
ca. 21,5 x 31 x 25/23 cm (B x L x H)

›BA-F CLIP STEM LONG‹
approx. 21.5 x 31 x 25/23 cm (W x L x H)



431502
U
12,90 €

- DRAHTKORB ›BA-F HANG‹**
- besonders **stabile** und **hochwertige Ausführung**
 - **universeller, biegsamer Befestigungsbügel**
 - für Lenker
 - ca. 34,5 x 25,5 x 26/23 cm
 - **kunststoffummantelter, ergonomischer Tragegriff**
 - mit M-Wave Logoplatte

- WIRE BASKET ›BA-F HANG‹**
- very **firm** and **high quality design**
 - **universal, twistable mounting bracket**
 - for handlebar
 - approx. 34.5 x 25.5 x 26/23 cm
 - **plastic covered ergonomic handle**
 - with M-Wave Logo plate



122479
U
27,90 €

LENKERBOX ›AMSTERDAM BOX FRONT‹

- **abschließbar**, inkl. 2 Schlüssel
- zur Montage am Steuersatz (1") und der Vorderradnabe (Adapter für 1½" Steuersatz erhältlich = Art. 431799)
- aus Kunststoff
- **staub- und spritzwassergeschützt**
- passend für 26" - 29" Reifen
- Bügel zum leichten Öffnen und zum Schutz des Schließzylinders
- Volumen ca. 17 Liter
- ca. 23 x 26 x 33 cm

FRONT TOP CASE ›AMSTERDAM BOX FRONT‹

- **lockable**, incl. 2 keys
- for mounting at the head set (1") and the front wheel hub (adapter for 1½" head set available = art. 431799)
- plastic
- **dust and water protected**
- suitable for 26" - 29" tires
- bracket for easy opening and for protection of the lock cylinder
- volume approx. 17 litres
- approx. 23 x 26 x 33 cm



ART.-NR. UVP **BESCHREIBUNG**

DESCRIPTION

431542 DRAHTKORB ›BA-RM CLAMP L‹

27,90 €



- besonders **stabile** und **hochwertige Ausführung**
- **verstärkte** Haupt- und Nebenstreben
- **2 mit Schaumstoff ummantelte Tragegriffe**
- ca. 45,5 x 29,5 x 21/13 cm (B x L x H)
- werkzeuglose Montage mit **Clip-on Klemmbefestigung**
- mit M-Wave Logoplatte
- mit M-Wave Karte

WIRE BASKET ›BA-RM CLAMP L‹

- very **firm** and **high quality design**
- **reinforced** main and auxiliary bars
- **2 foam covered handles**
- approx. 45.5 x 29.5 x 21/13 cm (W x L x H)
- toolless mounting with **clip-on clamp fixation**
- with M-Wave logo plate
- with M-Wave card

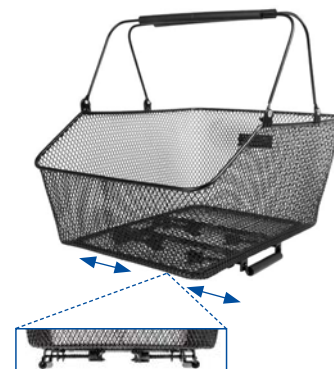

431593 DRAHTKORB ›BA-RM CLAMP W‹

22,90 €



- besonders **stabile** und **hochwertige Ausführung**
- **verstärkte** Haupt- und Nebenstreben
- **kunststoffummantelter, ergonomischer Tragegriff**
- ca. 41 x 31 x 17 cm
- werkzeuglose Montage mit **Clip-on Klemmbefestigung**
- mit M-Wave Logoplatte
- mit M-Wave Karte

WIRE BASKET ›BA-RM CLAMP W‹

- very **firm** and **high quality design**
- **reinforced** main and auxiliary bars
- **plastic covered ergonomic handle**
- approx. 41 x 31 x 17 cm
- toolless mounting with **clip-on clamp fixation**
- with M-Wave logo plate
- with M-Wave card



431592 DRAHTKORB ›BA-RM XL‹

22,90 €

- besonders **stabile** und **hochwertige Ausführung**
- **verstärkte** Haupt- und Nebenstreben
- **kunststoffummantelter, ergonomischer Tragegriff**
- ca. 51 x 30 x 20 cm
- besonders **breit** für Schultaschen und Aktenkoffer
- mit M-Wave Logoplatte

WIRE BASKET ›BA-RM XL‹

- very **firm** and **high quality design**
- **reinforced** main and auxiliary bars
- **plastic covered ergonomic handle**
- approx. 51 x 30 x 20 cm
- very **wide** for school bags and briefcases
- with M-Wave logo plate



XXL DRAHTKORB

- **stabile** und **hochwertige Ausführung**
- **verstärkte** Haupt- und Nebenstreben
- mit M-Wave Logoplatte
- mit M-Wave Karte

WIRE BASKET

- **firm** and **high quality design**
- **reinforced** main and auxiliary bars
- with M-Wave logo plate
- with M-Wave card

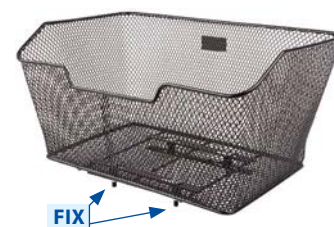

431594 ›BA-RM XXL‹

19,90 €

- zur **festen Montage quer** über dem Gepäckträger
- XL: ca. 30,5 x 48,5 x 23/15 cm (L x B x H)

›BA-RM XXL‹

- for **fixed installation across** on the carrier
- XL: approx. 30.5 x 48.5 x 23/15 cm (L x W x H)

431550 ›BA-RM Along‹

18,90 €

- zur **festen Montage längs** über dem Gepäckträger
- ca. 45 x 30 x 20/13 cm (L x B x H)
- besonders **schmal** und daher nicht seitlich überstehend

›BA-RM Along‹

- for **fixed installation lengthwise** on the carrier
- approx. 45 x 30 x 20/13 cm (L x W x H)
- extra **narrow**, therefore non-protruding from both sides

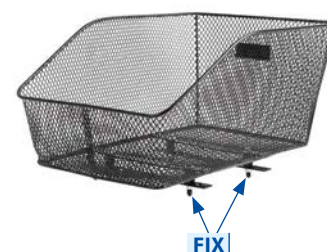

ART.-NR. UVP **BESCHREIBUNG** **DESCRIPTION**

431630 **DRAHTKORB**
 ›BA-R HANG CARRIER‹
 U
 18,90 €

- besonders **stabile** und **hochwertige Ausführung**
- **universeller, biegbarer Befestigungsbügel und Klettverschluss**
- zur **seitlichen Montage am Gepäckträger**
- 37 x 19 x 25 cm
- **kunststoffummantelter, ergonomischer Tragegriff**
- mit M-Wave Logoplatte
- mit M-Wave Karte

WIRE BASKET
 ›BA-R HANG CARRIER‹

- very **firm** and **high quality design**
- **universal, twistable mounting bracket and hook and loop fastener**
- for **mounting sidewise on the carrier**
- 37 x 19 x 25 cm
- **plastic covered, ergonomic handle**
- with M-Wave logo plate
- with M-Wave card



431591 **DRAHTKÖRBE** ›BA-RM‹
 U
 12,90 €

- besonders **stabile** und **hochwertige Ausführung**
- schwarz
- **verstärkte** Haupt- und Nebenstreben
- **kunststoffummantelter, ergonomischer Tragegriff**
- ca. 41 x 31 x 16 cm
- besonders engmaschig
- mit M-Wave Logoplatte

WIRE BASKETS ›BA-RM‹

- very **firm** and **high quality design**
- black
- **reinforced** main and auxiliary bars
- **plastic covered, ergonomic handle**
- approx. 41 x 31 x 16 cm
- very small meshed
- with M-Wave logo plate



122352 **KORB + TASCHE**
 U
 11,90 €

KORB + TASCHE
 ›MAASTRICHT PROTECT‹

- **universeller** Regenschutz für **Körbe**, Rucksäcke bis ca. 25 Liter, Vorderradtaschen, Gepäcktaschen, ...
- mit **2 Haltegurten** auf der Rückseite
- neongelb
- **3M Scotchlite® Reflexstreifen** auf drei Seiten
- mit aufgesetzter Netztasche
- auf M-Wave Eurolochkarte

BASKET + BAG COVER
 ›MAASTRICHT PROTECT‹

- **universal** rain protection for **baskets**, backpack up to approx. 25 litres, front bags, rear bags, ...
- with **2 fixation straps** on back
- neon yellow
- **3M Scotchlite® reflective stripes** on three sides
- with fitted net pocket
- on M-Wave eurohole card

3M Scotchlite®
 Reflective Material



440174 **ALUMINIUM-GEPACKTRÄGER**
 U
 29,90 €

ALUMINIUM CARRIER
 ›ONE - 4 - ALL‹

- **verstellbar** für 20" - 29"
- besonders geeignet **für Rahmen mit schwierigen Befestigungsmöglichkeiten** (z. B. wegen Scheibenbremsaufnahme), da **Seitenstreben** in Neigung und Länge **einzel**n **verstellbar** sind
- mit Reflektor-/Rücklichthalter und Federklappe
- mit **Universalbefestigungsset**
- mit **Nirosta**-Befestigungsmaterial
- Auflagefläche: 39 x 14 cm (L x B)
- mit M-Wave Eurolochkarte

ALUMINIUM CARRIER
 ›ONE - 4 - ALL‹

- **adjustable** for 20" - 29"
- specially suitable **for frames with difficult mounting facilities** (e. g. due to disc brake mounts), because the **side bars** are **individually adjustable** in length and tilt
- with reflector/rear light bracket and spring flap
- with **universal fitting set**
- with **stainless steel** mounting material
- loading surface: 39 x 14 cm (L x W)
- with M-Wave eurohole card

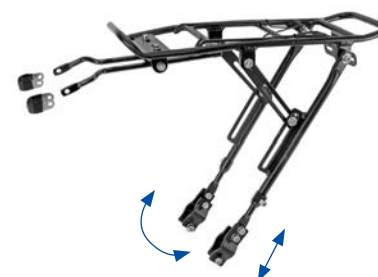

ART.-NR. BESCHREIBUNG
UVP

DESCRIPTION

ALUMINIUM-GEPÄCKTRÄGER
›SCREW - ON II A‹

- **verstellbar** für 24"/26"/28"
- aus **4-kant Aluminium-Rohr**
- mit Reflektor-/Rücklichthalter und Federklappe
- mit **Pumpenspitzen**
- mit **Universalbefestigungsset**
- kleines Verpackungs- und Präsentationsmaß (**Seitenteile abnehmbar**)
- mit **Nirosta-Schrauben**
- Auflagefläche: 37,5 x 13 cm (L x B)
- in M-Wave **Blisterverpackung**

ALUMINIUM CARRIER
›SCREW - ON II A‹

- **adjustable** for 24"/26"/28"
- **square type aluminium tube**
- with reflector/rear light bracket and spring flap
- with **pump pegs**
- with **universal fitting set**
- small packaging and presentation size (**side parts detachable**)
- with **stainless steel screws**
- loading surface: 37.5 x 13 cm (L x W)
- in M-Wave **blister packaging**

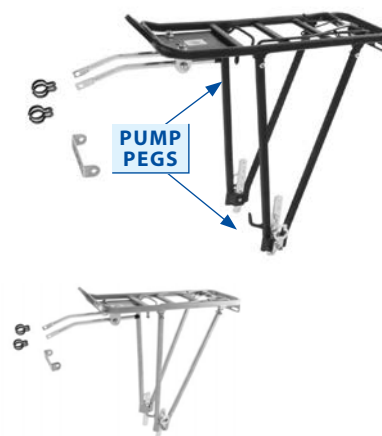

440158 schwarz

black

440157 silber
26,90 €

silver

440454 **MINI-GEPÄCKTRÄGER**
›MINI F + R‹
15,90 €

2 IN 1

- aus **Aluminium**
- universell einsetzbar für **vorne** oder **hinten**
- nur **254 g**
- Befestigung an den **Bremssockeln** und Gabelbrücke (vorne) oder Sitzstrebenbrücke/Pletscherplatte (hinten)
- für 24" - 28"
- mit **Nirostaschrauben**
- mit Reflektorhalter
- inkl. Befestigungsmaterial
- Auflagefläche: 22 x 14 cm (L x B)

MINI PANNIER RACK
›MINI F + R‹

- made of **aluminium**
- universal fitting for **front** or **rear**
- only **254 g**
- for mounting at the **brake pivots** and fork crown (front) or seat stay bridge/Pletscher plate (rear)
- for 24" - 28"
- with **stainless steel screws**
- with reflector bracket
- incl. mounting material
- loading surface: 22 x 14 cm (L x W)



449902 **GEPÄCKTRÄGERPLATTE**
›RACKY BASEPLATE‹
21,90 €

- **Aluminium**
- Trägerplatte zur **Vergrößerung der Auflagefläche des Gepäckträgers**
- inkl. **3 Universalbefestigungsstreben**
- für alle gängigen Gepäckträger
- 400 x 400 mm
- mit M-Wave Banderole

CARRIER PLATE
›RACKY BASEPLATE‹

- **aluminium**
- carrier plate for **enlarging the contact area of the carrier**
- incl. **3 universal mounting struts**
- for all common carriers
- 400 x 400 mm
- with M-Wave banderole



440490 **SCHNELLSPANNER SET**
9,90 €

- **zur Montage von Gepäckträgern an Rädern:**
 - **ohne Befestigungsösen** (z. B. Rennräder)
 - mit **hinderlichen Sitzrohr- oder Kettenstreben, Ausfallenden, ...**
- passend auch für **Fahrradanhänger** Art. 640050, ...
- mit 8 je 5 mm breiten **Adapter-scheiben**
- **Aluminiumhebel**
- Länge 210 mm
- für Nabeneinbaumaß: ≥ 130 mm
- **Einklembreite: 137 - 177 mm** (in 5 mm Schritten)
- auf M-Wave Euro-lochkarte

QUICK RELEASE SET

- **for mounting of carriers to bicycles:**
 - **without mounting eyelets** (e. g. road bikes)
 - with **obstructive seat stays, chain stays, derailleur hangers, ...**
- also suitable for **bicycle trailer** art. 640050, ...
- with 8 **adapters**, each 5 mm wide
- **aluminium lever**
- length 210 mm
- OLD: ≥ 130 mm
- **clamp width: 137 - 177 mm** (in 5 mm steps)
- on M-Wave eurohole card

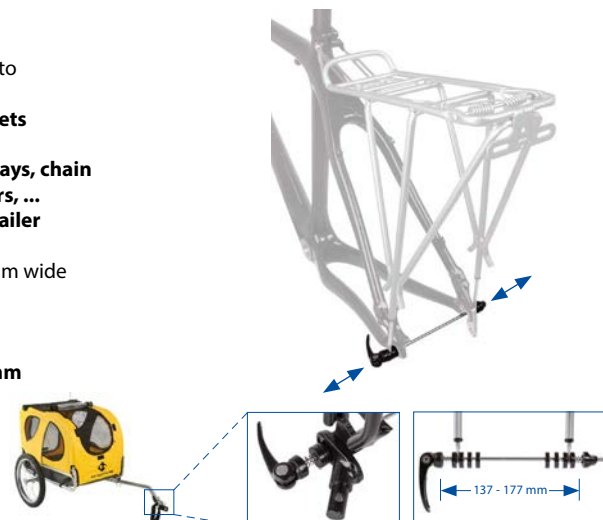

ART.-NR. UVP **BESCHREIBUNG**

DESCRIPTION

STECKACHSE FÜR ANHÄNGERKUPPLUNG
›STALWART AXLE‹

- durch Innengewinde auch zur **Montage von Gepäckträgern an Steckachsen** geeignet
- zur **werkzeuglosen Montage von Standard Fahrrad-Anhänger-Kupplungen** an **12 mm Steckachs-naben**
- **2 in 1:** durch 6 mm Distanzscheibe passend für 12 mm Steckachs-naben mit **142 mm** Einbaumaß und für **Boost-Naben** mit **148 mm** Einbaumaß
- Aluminium
- mit Schnellspanner
- auch **ohne Schnellspanner als saubere Lösung** für Steckachsen nutzbar
- mit zusätzlichem Innengewinde für M6-Schrauben, für z. B. Gepäckträgermontage
- mit zusätzlichen Unterlegscheiben zur **Einstellung der Schnellspannhebel-Position**
- auf M-Wave Eurolochkarte

640140

U

- **Shimano Type** (kein original Shimano Ersatzteil)
- Gewindesteigung: P1.5 x T20

640141

U

- **Maxle Type** (kein original Maxle Ersatzteil)
- Gewindesteigung: P1.75 x T20

640142

U
44,90 €

- **Syntace Type** (kein original Syntace Ersatzteil)
- Gewindesteigung: P1.0 x T20
- mit konischer Verbindungsscheibe

THRU AXLE FOR TRAILER MOUNT
›STALWART AXLE‹

- due to the internal thread also suitable for **mounting carriers to thru axles**
- for **toolless mounting of standard bicycle trailer adapters** at **12 mm thru axle hubs**
- **2 in 1:** by 6 mm spacer suitable for 12 mm thru axle hubs with **OLD 142 mm** and for **boost hubs** with **OLD 148 mm**
- aluminium
- with QR
- also usable **without QR as clean solution** for quick-release axle
- with additional internal thread for M6 screws for e. g. carrier assembly
- with additional spacers for **adjusting the QR lever position**
- on M-Wave eurohole card

• **Shimano Type**

- (no original Shimano spare part)
- thread pitch: P1.5 x T20

• **Maxle Type**

- (no original Maxle spare part)
- thread pitch: P1.75 x T20

• **Syntace Type**

- (no original Syntace spare part)
- thread pitch: P1.0 x T20
- with conical spacer

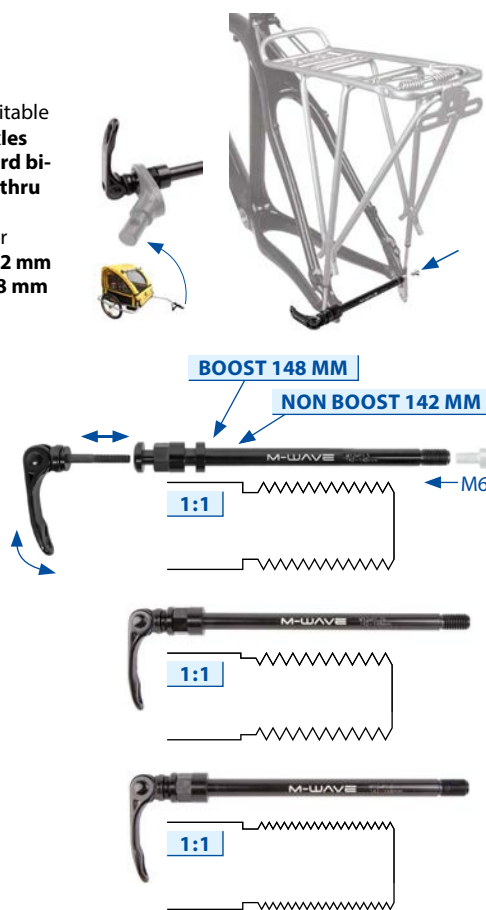

E-BIKE

E-BIKE



466142

39,90 €

E-BIKE-SCHEINWERFER
›APOLLON E 100‹



- **100 Lux**
- 6 - 48 V DC/1,4 W
- hochwertiges **Aluminium-/Kunststoffgehäuse**
- mit **deutschem Prüfzeichen**
- **abnehmbarer Reflektor**
- mit **2-fach verstellbarem Halter**
- mit Doppelkabel, 10 cm, mit Flachstecker
- auf M-Wave Eurolochkarte

E-BIKE HEAD LAMP
›APOLLON E 100‹

- **100 Lux**
- 6 - 48 V DC/1.4 W
- high quality **aluminium/plastic housing**
- with **German approval number**
- **removable reflector**
- with **double adjustable bracket**
- with double cable, 10 cm, with flat plug
- on M-Wave eurohole card



466141

19,90 €

E-BIKE-SCHEINWERFER
›APOLLON E 80‹



- **80 Lux**
- 6 - 48 V DC/2,4 W
- mit **deutschem Prüfzeichen**
- **abnehmbarer Reflektor**
- mit **2-fach verstellbarem Halter**
- mit Doppelkabel, 10 cm, mit Flachstecker
- auf M-Wave Eurolochkarte

E-BIKE HEAD LAMP
›APOLLON E 80‹

- **80 Lux**
- 6 - 48 V DC/2.4 W
- with **German approval number**
- **removable reflector**
- with **double adjustable bracket**
- with double cable, 10 cm, with flat plug
- on M-Wave eurohole card



ART.-NR. BESCHREIBUNG
UVP

DESCRIPTION

466143 E-BIKE-SCHEINWERFER
›APOLLON E 30‹

12,90 €



30 LUX

- **30 Lux**
- 6 - 48 V DC/1,3 W
- mit **deutschem Prüfzeichen**
- Reflektor mit deutschem Prüfzeichen
- mit Edelstahlhalter
- mit Doppelkabel, 10 cm, mit Flachstecker
- Montageverpackung

E-BIKE HEAD LAMP
›APOLLON E 30‹

- **30 Lux**
- 6 - 48 V DC/1.3 W
- with **German approval number**
- reflector with German approval number
- with stainless steel bracket
- with double cable, 10 cm, with flat plug
- OEM



DYNAMO

DYNAMO



50 LUX

STAND LIGHT

LED-DYNAMOSCHEINWERFER
›APOLLON D 50‹

- **50 Lux**
- 6 V/3 W
- mit **Ein-/Ausschalter**
- mit **Standlichtfunktion**
- mit **deutschem Prüfzeichen**
- **abnehmbarer** Reflektor
- mit Edelstahlhalter
- mit Doppelkabel

LED DYNAMO HEAD LAMP
›APOLLON D 50‹

- **50 Lux**
- 6 V/3 W
- with **on/off switch**
- with **standlight function**
- with **German approval number**
- **removable** reflector
- with stainless steel bracket
- with double cable



461606 Montageverpackung

OEM

461607 auf M-Wave Eurolochkarte

on M-Wave eurohole card

14,90 €



30 LUX

STAND LIGHT

LED-DYNAMOSCHEINWERFER
›APOLLON D 30‹

- **30 Lux**
- 6 V/3 W
- mit **Ein-/Ausschalter** (für Vorder- und Rücklicht)
- mit **Standlichtfunktion**
- mit **deutschem Prüfzeichen**
- **abnehmbarer** Reflektor
- mit Edelstahlhalter
- mit 2 Doppelkabeln, 100 cm
- 2 im Gehäuse integrierte Flachsteckeranschlüsse

LED DYNAMO HEAD LAMP
›APOLLON D 30‹

- **30 Lux**
- 6 V/3 W
- with **on/off switch** (for front and rear light)
- with **standlight function**
- with **German approval number**
- **removable** reflector
- with stainless steel bracket
- with 2 double cables, 100 cm
- 2 flat plugs integrated in the housing



• **466944** Montageverpackung

OEM

466945 auf M-Wave Eurolochkarte

on M-Wave eurohole card

12,90 €

ART.-NR. BESCHREIBUNG
UVP

DESCRIPTION

E-BIKE

E-BIKE 

466151 E-BIKE-GEPÄCKTRÄGER-RÜCKLICHT ›HELIOS E BRAKE‹

14,90 €



- 6 - 48 V DC/0,6 W
- **2 superhelle, rote LEDs an den Seiten**
- **COB LED** (21 Chips)
- mit **deutschem Prüfzeichen**
- mit **Bremslichtfunktion**
- integrierter Z-Reflektor
- für Lochabstand 80 mm
- 2 im Gehäuse integrierte Flachsteckanschlüsse
- auf M-Wave Eurolochkarte

E-BIKE CARRIER REAR LIGHT ›HELIOS E BRAKE‹

- 6 - 48 V DC/0.6 W
- **2 super bright, red LEDs at the sides**
- **COB LED** (21 chips)
- with **German approval number**
- with **brake light function**
- integrated Z-reflector
- for hole distance 80 mm
- 2 flat plugs integrated in the housing
- on M-Wave eurohole card



• 466150 E-BIKE-GEPÄCKTRÄGER-RÜCKLICHT ›HELIOS E‹

7,90 €



- 6 - 48 V DC/0,6 W
- 3 superhelle, rote **LEDs**
- mit **deutschem Prüfzeichen**
- integrierter Z-Reflektor
- für Lochabstand 80 mm
- 2 im Gehäuse integrierte Flachsteckanschlüsse
- Montageverpackung

E-BIKE CARRIER REAR LIGHT ›HELIOS E‹

- 6 - 48 V DC/0.6 W
- 3 super bright, red **LEDs**
- with **German approval number**
- integrated Z-reflector
- for hole distance 80 mm
- 2 flat plugs integrated in the housing
- OEM



DYNAMO

DYNAMO

• 466905 DYNAMO-GEPÄCKTRÄGER-RÜCKLICHT ›HELIOS D‹

7,90 €



- 1 **superhelle, rote LED**
- 6 V/3 W
- mit **Standlichtfunktion**
- mit **deutschem Prüfzeichen**
- integrierter Z-Reflektor
- Stecker für **Doppelanschluss** (+ und -)
- für Lochabstand **50 und 80 mm**
- inkl. Befestigungsschrauben und Muttern
- Montageverpackung

DYNAMO CARRIER REAR LIGHT ›HELIOS D‹

- 1 **super bright, red LED**
- 6 V/3 W
- with **standlight function**
- with **German approval number**
- integrated Z-reflector
- plug for **double connection** (+ and -)
- for hole distance **50 and 80 mm**
- incl. fastening screws und nuts
- OEM



• 466950 AKKU-GEPÄCKTRÄGER-RÜCKLICHT ›HELIOS USB‹

11,90 €



- 1 **superhelle, rote LED**
- 3,7 V/300 mAh
- mit **Lithium-Polymer Akku**
- mit **deutschem Prüfzeichen**
- integrierter Z-Reflektor
- mit **Ladezustandsanzeige**
- für Lochabstand 50 und 80 mm
- **2 in 1**: Gummihalter (Art. 223561) für Sattelstützmontage und Befestigungsschrauben für Gepäckträgermontage
- **inkl. USB-Kabel**
- auf M-Wave Eurolochkarte

RECHARGEABLE CARRIER REAR LIGHT ›HELIOS USB‹

- 1 **super bright, red LED**
- 3.7 V/300 mAh
- with **lithium polymer rechargeable battery**
- with **German approval number**
- integrated Z-reflector
- with **charge control indicator**
- for hole distance 50 and 80 mm
- **2 in 1**: rubber bracket (art. 223561) for seat post mounting and fastening screws for carrier mounting
- **incl. USB cable**
- on M-Wave eurohole card



BATTERIE-GEPÄCKTRÄGER-RÜCKLICHT ›HELIOS B‹

- 2 **superhelle, rote LEDs**
- mit **deutschem Prüfzeichen**
- integrierter Z-Reflektor
- mit **Batteriezustandsanzeige**
- inkl. Batterien (2x AAA)
- für Lochabstand 50 und 80 mm
- inkl. Befestigungsschrauben und Muttern

BATTERY CARRIER REAR LIGHT ›HELIOS B‹

- 2 **super bright, red LEDs**
- with **German approval number**
- integrated Z-reflector
- with **battery level indicator**
- incl. Batteries (2x AAA)
- for hole distance 50 and 80 mm
- incl. fastening screws und nuts

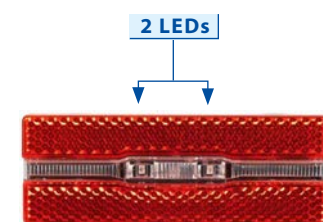

466925 Montageverpackung

OEM

466926 auf M-Wave Eurolochkarte

on M-Wave eurohole card

9,90 €

ART.-NR. BESCHREIBUNG
UVP

DESCRIPTION

466670 3M™ SCOTCHLITE
U 9,90 € SPEICHERREFLEKTOR



- **3M ScotchLite®** Reflexmaterial
- **360° Sichtbarkeit**
- Länge: 70 mm
- einfache Montage ohne Werkzeug
- mit **deutschem Prüfzeichen** (gültig bei Anbringung an 36 Speichen in einem Laufrad)
- 1 Set = 18 Stück
- in M-Wave Blisterverpackung

3M™ SCOTCHLITE
SPOKE REFLECTOR

- **3M ScotchLite®** reflective material
- **360° visibility**
- length: 70 mm
- easy mounting without tools
- with **German approval number** (only applies when mounted on 36 spokes in one wheel)
- 1 set = 18 pcs
- in M-Wave blister packaging



470415 ELEKTRISCHE PUMPE
U 89,90 € ›ELUMATIK USB 2 / AP-117‹



- **kleines, handliches Format**
- **Druck voreinstellbar**
- pumpt Schläuche, Bälle, Luftmatratzen,... **selbstständig** bis zum **voreingestellten Druck** auf und schaltet dann automatisch ab
- **Lithium-Ionen-Akku**
- mit **Micro USB Ladebuchse** (Ladekabel enthalten)
- **beleuchtetes LCD-Display**
- mit wasserdichter Tasche, welche mit 3 Klettverschlüssen werkzeuglos am Oberrohr angebracht werden kann
- bis max. 150 psi / 10,3 bar
- **Universal-Doppelpumpenkopf** für FV / AV / DV
- mit Adapter für Luftmatratze und Ballnadel
- mit integriertem **LED-Licht**
- in M-Wave Einzelkarton

ELECTRIC PUMP
›ELUMATIK USB 2 / AP-117‹

- **small and compact**
- **pressure presetting**
- pumps up tubes, balls, air mattresses,... **autonomously** up to the **default pressure** and turns off automatically afterwards
- **Lithium Ion rechargeable battery**
- with **micro USB charging port** (charging cable included)
- **illuminated LCD display**
- with waterproof bag, which can be toollessly mounted to the top tube by 3 hook and loop fasteners
- up to max. 150 psi / 10.3 bar
- **universal double pump head** for FV / AV / DV
- with adapter for air mattress and ball needle
- with integrated **LED light**
- in M-Wave box



470281 MINI-PUMPE
U 17,90 € ›AIR MIDGET‹



- **CNC-gefrästes Aluminium**
- nur **68 g**
- nur **120 mm**
- bis 6,2 bar / 90 psi
- mit Halter und Gummibandbefestigung
- für FV, AV und DV
- auf M-Wave Eurolochkarte

MINI PUMP ›AIR MIDGET‹

- **CNC machined aluminium**
- only **68 g**
- only **120 mm**
- up to 6.2 bar / 90 psi
- with bracket and rubber strap
- for FV, AV and DV
- on M-Wave eurohole card



470337 DOPPELKOPFPUMPE
U 12,90 € ›DOUBLE SHOT B‹

- **Aluminium**
- mit **Manometer** und **“Double Shot“-Funktion**
- bis 8,5 bar / 120 psi
- mit **Universal-Doppelpumpenkopf** für AV, FV und DV
- mit **rutschfestem Softgriff**
- mit Halter
- mit **Schnellverschluss**
- mit Staubschutzkappe
- auf M-Wave Eurolochkarte

DOUBLE HEAD PUMP
›DOUBLE SHOT B‹

- **aluminium**
- with **manometer** and **“Double Shot” function**
- up to 8.5 bar / 120 psi
- with **universal double pump head** for AV, FV and DV
- with **non-slip soft handle**
- with bracket
- with **quick fastening lever**
- with dust protection cap
- on M-Wave eurohole card



ART.-NR. UVP **BESCHREIBUNG**

DESCRIPTION

- 470280 U**
9,90 €
- PUMPE ›FLEXI TUBE‹**
- Aluminiumpumpe
 - mit herausnehmbarem, 150 mm langem Schlauch
 - nur 89 g
 - mit Halter und Sicherungsband
 - mit Staubschutzkappe
 - für FV, AV und DV
 - auf M-Wave Eurolochkarte

- PUMP ›FLEXI TUBE‹**
- aluminium pump
 - with removable, 150 mm long tube
 - only 89 g
 - with bracket and safety strap
 - with dust protection cap
 - for FV, AV and DV
 - on M-Wave eurohole card



Pumps

- 470335 U**
146,90 €
- STANDPUMPE ›AIR BULLET‹**
- TUBE LESS**
- mit Lufttank
 - sekundenschnelle Befüllung oder normal pumpen
 - insbesondere für die Montage schlauchloser Reifen geeignet
 - Aluminium
 - bis 18 bar / 260 psi
 - Manometer an der Oberseite für leichtes Ablesen
 - stabiler Fuß mit Anti-Rutsch-Einlage
 - mit Universal-Pumpenkopf für FV, AV und DV
 - extra langer Pumpenschlauch
 - mit M-Wave Karte

- FLOOR PUMP ›AIR BULLET‹**
- with air tank
 - inflation within seconds or normal pumping
 - in particular suitable for tubeless tires mounting
 - aluminium
 - up to 18 bar / 260 psi
 - top-mounted manometer for easy reading
 - stable base with non-slip pad
 - universal pump head for FV, AV and DV
 - extra long pump tube
 - with M-Wave tag



- 470531 U**
44,90 €
- STANDPUMPE ›AIR FLOW‹**
- großes, flaches, gut lesbares Manometer
 - poliertes Aluminium
 - extra langer Pumpenschlauch
 - bis 10 bar / 145 psi
 - mit Universal-Pumpenkopf für FV, AV und DV mit Schnellverschlusshebel
 - Ballnadel und Luftmatratzenadapter
 - mit M-Wave Karte

- FLOOR PUMP ›AIR FLOW‹**
- big, flat, well readable manometer
 - polished aluminium
 - extra long pump tube
 - up to 10 bar / 145 psi
 - universal pump head for FV, AV and DV with quick fastening lever
 - ball needle and adapter for air mattress
 - with M-Wave tag



- 470375 U**
28,90 €
- STANDPUMPE ›AIR JET‹**
- XL MANOMETER**
- extra großes, gut lesbares Manometer
 - bis 11 bar / 160 psi
 - Non-Slip Zweikomponentengriff
 - stabiler Fuß
 - mit Universal-Pumpenkopf für FV, AV und DV
 - mit M-Wave Karte

- FLOOR PUMP ›AIR JET‹**
- extra big, well readable manometer
 - up to 11 bar / 160 psi
 - non-slip 2-component handle
 - stable base
 - universal pump head for FV, AV and DV
 - with M-Wave tag



ART.-NR. BESCHREIBUNG
UVP

DESCRIPTION

470186 CO2-PATRONE

- 4,90 €
- **16 g**
- mit 3/8" Gewinde
- 2 Stück in M-Wave Eurolochbox

CO2 CARTRIDGE

- with 3/8" thread
- **16 g**
- 2 pieces in M-Wave eurohole box



ALUMINIUM-VENTILVERLÄNGERUNG

- für FV
- zur Verwendung in Hochprofilfelgen
- paarweise auf M-Wave Eurolochkarte

ALUMINIUM VALVE EXTENSION

- for FV
- for using with high profil rims
- one pair on M-Wave eurohole card

519947

- 9,90 €
- verlängert das Ventil um **50 mm**
- **gedichtet**
- für FV mit heraus-schraubbarem Ventileinsatz
- mit Werkzeug zum Heraus-schrauben des Ventileinsatzes
- schwarz

- prolongs the valve by **50 mm**
- **sealed**
- for FV with removable valve insert
- with tool to unscrew the valve insert
- black



519948

- 6,90 €
- verlängert das Ventil um **40 mm**
- silber

- prolongs the valve by **40 mm**
- silver



**EVERYTHING
IN (RE-) VIEW**

M-WAVE SPY SPACE – BICYCLE MIRROR

- 3- dimensionally adjustable
- Antireflective, glare-free and blast resistant
- For mounting on the right and left
- Particularly suitable for e-bikes



TUBELESS: GUT - GÜNSTIG - 3 in 1!

Rennfahrer verwenden oft **normale Faltreifen** und unser Tubelesskit, um jedes Gramm **Gewicht zu sparen**. Nutzen auch Sie das schlauchlose System von **M-Wave** mit Ihren **bisherigen Reifen, SCT- oder UST-Reifen**. Mit dem Tubelesskit entfällt das Wechseln und Flickern von Schläuchen und Sie **sparen Gewicht**.

- 1) Jede **herkömmliche Felge** kann **kostengünstig** auf ein **Schlauchlos-system** umgerüstet werden.
- 2) M-Wave Tubelesskit ist auch für die **Verwendung mit Kenda SCT Reifen** geeignet. So können Sie ein Tubeless-System fahren, ohne dabei das höhere Gewicht und Kosten von UST-Reifen in Kauf nehmen zu müssen.
- 3) Mit dem M-Wave Tubelesskit kann mit **nur 2 bar Luftdruck** gefahren werden, ohne dass der Reifen durch einen Felgendurchschlag (Snakebite) gefährdet ist. Dadurch erreicht man:
 - a) eine **deutlich bessere Dämpfung**
 - b) **mehr Traktion** in jedem Gelände
 - c) bergauf kann man länger im Sattel bleiben
 - d) bergab **besseres Bremsverhalten**
 - e) mehr **Grip in Kurven**
 - f) dass mit **schmaleren** und damit **leichteren Reifen** gefahren werden kann.
- 4) Durch den Einsatz dieses Systems ist der **Rollwiderstand** gegenüber einem Schlauchsystem bis zu **15 % niedriger**.
- 5) Schlauchlosreifen können nicht immer 100 % luftdicht hergestellt werden. Mit dem M-Wave Tubelesskit wird der **Reifen dicht und ist für über 6 Monate selbstflickend** (bis zu 6 mm Löcher).

TUBELESS: GOOD QUALITY - FAIR PRICE - 3 in 1!

Racers often use **standard folding tires** and our Tublesskit in order to **save every gram of weight**. You can also use our Tubless System from **M-Wave** with your **existing tires, SCT or UST tires**. With this Tublesskit you can avoid tube changes and repairs and at the same time **reduce weight**.

- 1) Every **conventional rim** can be converted to a **tubeless system at low costs**.
- 2) M-Wave Tublesskit is also **usable for Kenda SCT tires**. Through this you can ride a tubeless system without having to accept the higher weight and costs of UST tires.
- 3) With the M-Wave tubelesskit **only 2 bar air pressure** are required without the risk of damaging the tire by snakebite (rim cut through the tire). The effects:
 - a) **distinctly improved damping**
 - b) **improved traction** in every terrain
 - c) uphill one can stay longer in the saddle
 - d) and downhill the **braking is improved**
 - e) more **grip in turns**
 - f) due to the above advantages **smaller and lighter tires** can be used.
- 4) Through the use of this tubeless system the **rolling resistance**, in comparison with a tube system, is about **15 % lower**.
- 5) Tubeless tires cannot be manufactured 100 % airtight. M-Wave tubelesskit makes them **self-repairing**- sealing liquid closes holes or other damages up to **6 mm diameter automatically and permanently**. It keeps this function for **longer than 6 months**.



TUBELESS HOCHDRUCK-FELGENBAND

- **selbstklebend**
- 10 Meter gerollt
- im Polybeutel mit M-Wave Eurolochheader

Breite:

519850	19 mm
9,90 €	
519822	21 mm
10,90 €	
519852	23 mm
11,90 €	
519824	25 mm
12,90 €	
519825	27 mm
13,90 €	
519842	30 mm
13,90 €	
519843	35 mm
13,90 €	

TUBELESS HIGH PRESSURE RIM TAPE

- **adhesive**
- 10 meters rolled
- in PE bag with M-Wave eurohole header

width:

19 mm
21 mm
23 mm
25 mm
27 mm
30 mm
35 mm



TUBELESS VENTIL

- **Carbon**
- inkl. **2 runder und 2 eckiger Dichtungen**
- **seitlicher Luftauslass**
- mit **Ventilwerkzeug/-kappe** (Art. 519819)
- 2x FV
- mit Befestigungsmuttern
- 1 Paar in M-Wave Eurolochbox

519870	Höhe: 35 mm
519871	Höhe: 45 mm
14,90 €	

TUBELESS VALVE

- **carbon**
- incl. **2 round and 2 square seal rings**
- **lateral air outlet**
- with **valve tool/cap** (art. 519819)
- 2x FV
- with fixing nuts
- 1 pair in M-Wave eurohole box

height: 35 mm
height: 45 mm



ART.-NR. UVP **BESCHREIBUNG**

DESCRIPTION

519463 ABDICHTFLÜSSIGKEIT ›TUBELESS SEALANT‹
9,90 €

- Abdichtflüssigkeit für **Tubeless-Reifen**
- versiegelt unmittelbar Löcher von bis zu 6 mm in der Lauffläche
- Dichtmittel ist **CO₂-Patronen-kompatibel**
- 125 ml

TIRE SEALANT ›TUBELESS SEALANT‹

- sealant for **tubeless tires**
- instantly seals puncture in tread up to 6 mm
- sealant is **CO₂ cartridge compatible**
- 125 ml



519828 TUBELESSKIT & PANNENSCHUTZ ›TU-KIT‹
39,90 €

20" - 29"

- 1 Set für **2 Reifen** bestehend aus:
 - 2 x F/V Tubeless-Ventile 47 mm
 - 1 x 10 m-Rolle selbstklebendes Tubeless-Felgenband, Breite 25 mm
 - 2 x 125 ml Abdichtflüssigkeit
 - Ventilwerkzeug
- in M-Wave Eurolochbox

TUBELESSKIT & FLAT PREVENTION ›TU-KIT‹

- 1 set for **2 wheels** consisting of:
 - 2 x F/V tubeless valves 47 mm
 - 1 x 10 m roll adhesive tubeless rim tape, width 25 mm
 - 2 x 125 ml tubeless sealant
 - valve tool
- in M-Wave eurohole box



Gerne stellen wir für Sie Ihr individuelles Tubeless-Set zusammen. Wählen Sie dabei ein Felgenband in der passenden Breite und die passenden Ventile aus. Dazu kommt zu jedem Set das Ventilwerkzeug (Art. 519819) und zwei Flaschen Dichtflüssigkeit (Art. 519463).

We gladly arrange your individual tubeless set. Choose one rim tape in the appropriate width and the suitable valves. With every set comes a valve tool (art. 519819) and two bottles of sealant fluid (art. 519463).

519461 TUBELESSKIT & PANNENSCHUTZ 26" - 29" ›ECO‹
34,90 €

26" - 29"

- für fast alle handelsüblichen Hohlkammerfelgen mit FV-Felgenloch
- Felgenbreite 17 - 19 mm (innen)
- 1 Set für **2 Reifen** bestehend aus:
 - 2 x 125 ml **Abdichtflüssigkeit** für Löcher bis **6 mm**
 - doppelseitiges Klebeband
 - 2 x Felgenband mit Ventileinbaukit
- Abdichtflüssigkeit **umweltfreundlich** und **latexfrei**
- in M-Wave Eurolochbox

TUBELESSKIT & FLAT PREVENTION 26" - 29" ›ECO‹

- for almost all conventional double wall rims with FV rim hole
- rim width 17 - 19 mm (inner)
- 1 set for **2 wheels** consisting of:
 - 2 x 125 ml **tubeless sealant** for holes up to **6 mm**
 - double sided glue strip
 - 2 x rim tape with valve mounting kit
- Eco sealant **eco-friendly** and **latex-free**
- in M-Wave eurohole box



518817 REIFEN- UND SCHLAUCH-PANNENSCHUTZ-FLÜSSIGKEIT
6,90 €

- verhindert und repariert Pannen an Schläuchen und Reifen jeglicher Art
- **dichtet Schäden bis 3 mm selbständig** während der Fahrt ab
- **mit Ventilschlüssel** zum Herausnehmen des Ventileinsatzes beim A/V
- spitzes Ventil zum **leichten Befüllen**
- im **Einzelkarton**, 16 Stück à **250 ml** im mehrsprachigen, verkaufsfördernden **Thekendisplay**

TIRE AND TUBE SEALANT

- prevents and repairs flat tires and tubes of any kind
- **seals damages up to 3 mm automatically** during ride
- **with valve key** to take out the valve from A/V
- pointed valve for **easy filling**
- in **single box**, 16 pcs à **250 ml** in multilingual sales promotion **display box**



ART.-NR. UVP	BESCHREIBUNG	DESCRIPTION	
880267 19,90 €	REIFENFLICK-SET ›TUBELESS FIX‹ <ul style="list-style-type: none"> in hochwertigem Aluminium Gehäuse 2 Funktionen: Reifen Reibahle und Einführwerkzeug verschieden dicke Streifen für kleine und große Löcher: 5 x Ø 1,5 mm 3 x Ø 3,5 mm Gehäuse dient bei Verwendung als Hebel auf M-Wave Eurolochkarte 	TUBELESS REPAIR KIT ›TUBELESS FIX‹ <ul style="list-style-type: none"> in high quality aluminium case 2 functions: tire reamer and insert tool stripes in different widths for small and big holes: 5 x Ø 1.5 mm 3 x Ø 3.5 mm case useable as lever on M-Wave eurohole card 	
880365 8,90 €	TUBELESS REPAIR KIT ›TUBELESS FIX ECO‹ <ul style="list-style-type: none"> mit Reibahle und Einführungs- werkzeug verschieden dicke Streifen für kleine und große Löcher 5 x Ø 1,5 mm 5 x Ø 3,5 mm in M-Wave Kunststoff-Box 	TUBELESS REPAIR KIT ›TUBELESS FIX ECO‹ <ul style="list-style-type: none"> tire reamer and insert tool stripes in different widths for small and big holes 5 x Ø 1,5 mm 5 x Ø 3,5 mm in M-Wave plastic box 	

Tire Accessories

519481 16,90 €	BEFÜLLSPRITZE FÜR DICHTMILCH <ul style="list-style-type: none"> ermöglicht schnelles, sauberes und kontrolliertes befüllen der Dichtmilch keine Demontage des Reifens nötig Dichtmilch kann (für mehr Pannenschutz) auch in einen vorhandenen Schlauch gefüllt werden Schraubadapter für AV und FV Behältnis kann bis zu 60 ml Dichtmilch aufnehmen es kann jede Dichtmilch verwendet werden, besonders geeignet für Art. 519463 in M-Wave Eurolochbox 	SEALANT SYRINGE INJECTOR <ul style="list-style-type: none"> quick, clean and controlled filling of the sealant no tire demounting necessary sealant can also be applied to inner tubes (for additional puncture control) screw-on adapter for AV and FV for up to 60 ml sealant compatible for all sealants, especially suitable for art. 519463 in M-Wave eurohole box 	
-------------------	---	--	---

AV/FV



ART.-NR. UVP	BESCHREIBUNG	DESCRIPTION
	HOCHDRUCK-FELGENBAND Top -Qualität 20 mm x 26" , 20-559	HIGH PRESSURE RIM TAPE Top quality 20 mm x 26" , 20-559
519200 3,90 €	2 Stück in M-Wave Eurolochbox	2 pieces in M-Wave eurohole box
• 519340 1,90 €/pc.	Montageverpackung	OEM
	20 mm x 27,5" , 20-584	20 mm x 27.5" , 20-584
519201 3,90 €	2 Stück in M-Wave Eurolochbox	2 pieces in M-Wave eurohole box
• 519309 1,90 €/pc.	Montageverpackung	OEM
	24 mm x 27,5" , 24-584 passend für viele Plus -Felgen (z.B. Art. 381150 ff., 380480 ff., ...)	24 mm x 27.5" , 24-584 suitable for a lot of plus rims (e.g. art. 381150 et seq., 380480 et seq., ...)
519205 4,90 €	2 Stück in M-Wave Eurolochbox	2 pieces in M-Wave eurohole box
• 519371 2,40 €/pc.	Montageverpackung	OEM
	16 mm x 28" / 29" / 700C , 16-622	16 mm x 28" / 29" / 700C , 16-622
519203 3,90 €	2 Stück in M-Wave Eurolochbox	2 pieces in M-Wave eurohole box
• 519341 1,90 €/pc.	Montageverpackung	OEM
	20 mm x 28" / 29" , 20-622	20 mm x 28" / 29" , 20-622
519204 3,90 €	2 Stück in M-Wave Eurolochbox	2 pieces in M-Wave eurohole box
• 519342 1,90 €/pc.	Montageverpackung	OEM
	24 mm x 28" / 29" , 24-622	24 mm x 28" / 29" , 24-622
519206 2,40 €/pc.	Montageverpackung	OEM



SELBSTKLEBENDES HOCHDRUCK-GEWEBE-FELGENBAND

- aus sehr hochwertigem, 0,5 mm starkem, blauem Nylongewebe
- eine spezielle Klebeschicht verhindert Verrutschen auch bei starker Belastung und hohen Temperaturen
- sehr leicht (nur 15 g bei 16-622)
- passend für 12" - 29"
- mit Ventilloch
- 1 Paar = 2 x 2 m in Polybeutel mit M-Wave Eurolochheader

SELF-ADHESIVE HIGH PRESSURE TEXTILE RIM TAPE

- high-grade, 0.5 mm thick, blue nylon fabric
- the special glue layer prevents the tape from slipping, even at intense strain or high temperatures
- very light (only 15 g in size 16-622)
- suitable for 12" - 29"
- with valve hole
- 1 pair = 2 x 2 m in PE-bag with M-Wave eurohole header

519400
U
519401
U
4,90 €

16 mm
20 mm

519909
U
44,90 €/set

VENTILKAPPEN-SET

- eloxiertes Aluminium
- für AV (und FV) geeignet durch Doppelgewinde
- 30 Stück, farbig sortiert
- in M-Wave Thekendisplay

VALVE CAP SET

- anodised aluminium
- suitable for AV (and FV) due to double threading
- 30 pieces, assorted colours
- in M-Wave sales display



ART.-NR. UVP	BESCHREIBUNG	DESCRIPTION	
612030 27,90 € 	E-BIKE MOTOR-SCHUTZHÜLLE ›E-PROTECT CENTER‹ <ul style="list-style-type: none"> • Universalgröße, ideal geeignet für E-Bike-Motoren von Shimano, Bosch, Brose, ... • Größe flexibel anpassbar • aus Neopren • schont den Motor durch Isolierung • schützt vor Kälte, Witterung und Schmutz • verhindert Kratzer, Steinschlag und Stoßschäden • in M-Wave Eurolochbox 	E-BIKE MOTOR PROTECTION COVER ›E-PROTECT CENTER‹ <ul style="list-style-type: none"> • universal size, ideally suitable for e-bike motors of Shimano, Bosch, Brose, ... • size flexibly adaptable • made of neoprene • protects the motor through isolation • protects from coldness, weather condition and dirt • prevents scratches, stone chipping and shock damages • in M-Wave eurohole box 	
612010 U 14,90 € 	E-BIKE AKKU-SCHUTZHÜLLE ›E-PROTECT‹ <ul style="list-style-type: none"> • universell passend für Bosch und Shimano Unterrohrakkus (kein original Bosch oder Shimano Ersatzteil) • verlängerte Akkulaufzeit durch Isolierung • aus Neopren • Schutz vor Kälte und Witterung • Schutz vor Kratzern, Steinschlag und Stoßschäden • in M-Wave Eurolochbox 	E-BIKE BATTERY PROTECTION ›E-PROTECT‹ <ul style="list-style-type: none"> • universal suitable for Bosch and Shimano down tube batteries (no original Bosch or Shimano spare part) • isolation provides extended battery capacity • made of neoprene • protection from coldness and weather condition • protection from scratches, stone chipping and shock damages • in M-Wave eurohole box 	  
612021 U 15,90 € 	E-BIKE AKKU-SCHUTZHÜLLE ›E-PROTECT WRAP‹ <ul style="list-style-type: none"> • Universalgröße für in den Rahmen integrierte E-Bikes Akkus • verlängerte Akkulaufzeit durch Isolierung • Schutz vor Kälte und Witterung, Kratzern, Steinschlag und Stoßschäden • aus Neopren • in M-Wave Eurolochbox 	E-BIKE BATTERY PROTECTION COVER ›E-PROTECT WRAP‹ <ul style="list-style-type: none"> • universal size for in the frame integrated e-bike batteries • isolation provides extended battery capacity • protection from coldness and weather condition, scratches, stone chipping and shock damages • made of neoprene • in M-Wave eurohole box 	
612020 U 19,90 € 	E-BIKE AKKU-SCHUTZHÜLLE ›E-PROTECT CARRIER‹ <ul style="list-style-type: none"> • Universalgröße, ideal geeignet für Gepäckträgerakkus von Bosch (und Shimano) • verlängerte Akkulaufzeit durch Isolierung • Schutz vor Kälte und Witterung • Schutz vor Kratzern, Steinschlag und Stoßschäden • aus Neopren • mit Öffnung zum Laden des Akkus im Gepäckträger (bei Bosch) • in M-Wave Eurolochbox 	E-BIKE BATTERY PROTECTION COVER ›E-PROTECT CARRIER‹ <ul style="list-style-type: none"> • universal size, ideally suitable for carrier batteries from Bosch (and Shimano) • isolation provides extended battery capacity • protection from coldness and weather condition • protection from scratches, stone chipping and shock damages • made of neoprene • with opening to charge the battery inside the carrier (Bosch battery) • in M-Wave eurohole box 	 
122538 U 37,90 € 	E-BIKE AKKUTASCHE ›ROUGH RIDE B‹ <ul style="list-style-type: none"> • universeller, gepolsterter Transportschutz für Unterrohr- und Gepäckträgerakkus • 100% wasserdicht • Rollverschluss ermöglicht variable Größeneinstellung • hohe Reißfestigkeit durch verstärktes Ripstop-Gewebe • universelle und sichere Befestigung durch breite Klettverschlüsse am Rahmenrohr, Gepäckträger, ... • mit non-slip Einlagen und Reflexlogo • Größe: ca. 55 x 8,5 x 13 cm (L x B x H) • Volumen ca. 7 L 	E-BIKE BATTERY BAG ›ROUGH RIDE B‹ <ul style="list-style-type: none"> • universal, padded transport protection for down tube and carrier batteries • 100% waterproof • expandable via roll cover • high tear resistance through reinforced ripstop textile • universal and secure mounting to the frame tube, carrier, ... with wide hook and loop fasteners • with non-slip inlays and reflex logo • size: approx. 55 x 8,5 x 13 cm (L x W x H) • volume approx. 7 litres 	  

E-Bike Protection Covers

ART.-NR. UVP **BESCHREIBUNG**

DESCRIPTION

612022 U **E-BIKE AKKU KONTAKTSCHUTZ**
›E-PROTECT CONNECT‹
 9,90 €



- **Universalgröße** zur **Abdeckung der Anschlusskontakte** am Rahmen bei entnommenen E-Bike Akkus
- Schutz vor Schmutz, Wasser und Beschädigung
- aus Neopren
- auf M-Wave Eurolochkarte

E-BIKE BATTERY CONNECTOR COVER ›E-PROTECT CONNECT‹

- **universal size to cover the connection contacts** of the frame with removed e-bike batteries
- protection from dirt, water and damages
- made of neoprene
- on M-Wave eurohole card



612040 U **COCKPIT-/LENKER-ABDECKUNG**
 12,90 €



- schützt **E-Bike Displays**, Schalt- und Bremshebel, Computer, ... vor Staub, Schmutz, Regen, ...
- wasserabweisend
- universell passend für (fast) alle Lenkerformen
- mit Gummizug und 4 Klettverschlüssen
- auf M-Wave Eurolochkarte

COCKPIT/HANDLEBAR COVER

- protects **e-bike displays**, shift and brake levers, computer, ... against dust, dirt, rain, ...
- water resistant
- universally suitable for (almost) all handlebar shapes
- with rubber band and 4 hook and loop fasteners
- on M-Wave eurohole card



612027 U **E-BIKE REMOTE UND DISPLAY SCHUTZ**
 8,90 € **›E-PROTECT‹**



- aus wasserabweisendem **Neopren**
- **universell passend** für (fast) alle **Remote-** und **Mitteldisplays** durch extra langen Klett- und zusätzlichen Kordelverschluss
- optimaler Schutz für Displays, Lenkerfernbedienungen, Anschlusskontakte, ...
- auf M-Wave Eurolochkarte

E-BIKE REMOTE AND DISPLAY PROTECTION ›E-PROTECT‹

- water resistant **neoprene** material
- **universally suitable** for (almost) all **remote** and **center displays** due to extra long hook and loop fastener and cord strap
- perfect protection for displays, remote lever, connection contacts, ...
- on M-Wave eurohole card



640093 **HARTSCHALEN-GEPÄCKANHÄNGER**
 699,00 € **›STALWART CARRY BOX‹**

- Zweispuranhänger mit **Hartschalen-**Gepäckbox
- Inhalt ca. 70 Liter, Box-Größe ca. 60 cm x 68 cm x 27 cm (B x L x H)
- **100 % wasserdicht**
- **abschließbar** mit Sicherheitsschloss
- bequemes und sicheres Be- und Entladen durch **hydraulisches Deckelöffnungsgestänge**
- mit **Gepäckträger auf dem Deckel**
- auch als **Handwagen, Einkaufswagen, ...** verwendbar
- **Aluminium-Rahmen, -Naben und -Felgen**
- abnehmbare **20" Laufräder mit Luftbereifung** und **Schnellverschluss**
- mit **Sicherheitsabweiser**
- mit **Schnellverschluss-Universalkupplung** (Art. 640028)
- max. Zuladung 25 kg, davon 3 kg auf dem Deckel

HARD BOX LUGGAGE TRAILER
›STALWART CARRY BOX‹

- double track luggage trailer with **hard luggage** box
- content approx. 70 ltrs, box size approx. 60 cm x 68 cm x 27 cm (W x L x H)
- **100 % waterproof**
- **lockable** by safety lock
- easy and safe (un)loading through **hydraulic lid**
- with **carrier on the lid**
- also usable as **hand cart, shopping trolley, ...**
- **aluminium** frame, hubs and rims
- detachable **20" wheels** with **air tires** and **QR**
- with **safety bumper**
- with **QR universal hitch** (art. 640028)
- max. load 25 kg, thereof 3 kg on lid

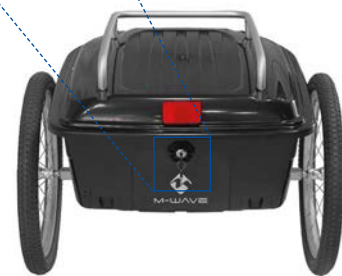

ART.-NR. BESCHREIBUNG
UVP

DESCRIPTION

640005 GEPÄCKANHÄNGER

›STALWART SHOP 2‹

319,90 €

3 IN 1

- **3 in 1** Anhänger: als **Fahrradanhänger**, bequemer **Einkaufstrolley** und **Sackkarre** verwendbar
- **werkzeuglos klappbare Anhängedeichsel**
- stabiler und leichter **Aluminium-Rahmen**
- mit Anhängerkupplung zur Befestigung an der Sattelstütze
- leichte 12" Laufräder mit **Kenda Luftreifen** und Aluminiumspeichen
- mit **großer** (53 x 37 x 26 cm (H x B x T), Volumen: 51 L) und **kleiner** (24 x 37 x 26 cm (H x B x T), Volumen: 23 L) **clip-on Gepäcktasche**
- Rücken aus Nylon 600D verhindert das Verschmutzen der Taschen
- ohne Tasche auch als leichte **Sackkarre** verwendbar
- max. Zuladung 21,4 kg
- Außenmaße (kompletter Anhänger, ausgeklappt) ca. 125 x 56 x 90 cm (L x B x H)

LUGGAGE TRAILER

›STALWART SHOP 2‹

- **3 in 1** trailer: as **bicycle trailer**, comfortable **shopping trolley** and **sacktruck** usable
- **toolless foldable trailer drawbar**
- strong and lightweight **aluminium frame**
- with trailer coupling for fastening at the seatpost
- lightweight 12" wheels with **Kenda air tire** and aluminium spokes
- with **big** (53 x 37 x 26 cm (H x W x D), Volumen: 51 L) and **small** (24 x 37 x 26 cm (H x W x D), Volumen: 23 L) **clip-on pannier**
- back made of nylon 600D prevents the bags from getting dirty
- without pannier also usable as lightweight **sacktruck**
- max. load 21.4 kg
- measurement outside (complete trailer, unfolded) approx. 125 x 56 x 90 cm (L x W x H)

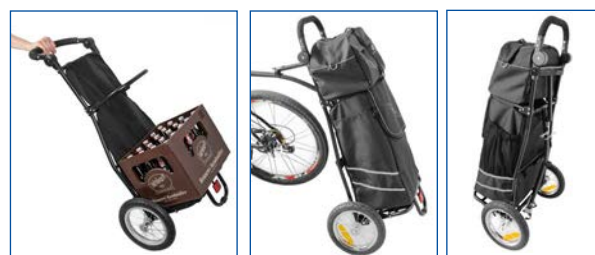

640060 FALT-GEPÄCKANHÄNGER

›STALWART CARRY FOLD 2‹

299,00 €

- **faltbarer Rahmen** aus Stahl
- Laufräder mit Schnellverschluss
- max. Zuladung 40 kg
- Aufsatzgröße außen:
(L) = 690 x (B) = 480 x (H) = 260 mm

FOLDABLE LUGGAGE TRAILER

›STALWART CARRY FOLD 2‹

- **foldable frame** made of steel
- wheels with quick release
- max. load 40 kg
- frame measurement outside:
(L) = 690 x (W) = 480 x (H) = 260 mm

640052
Ersatz-/Zweitkupplung/
replacement/second adapter



640063 HANDDEICHSEL

29,90 €

- für Art. 640060
- mit weichem Schaumstoffgriff
- Kupplung (Art. 640070/1) montierbar

HAND TOWING BAR

- for art. 640060
- with soft foam grip
- hitch (art. 640070/1) mountable



ART.-NR. BESCHREIBUNG
UVP

DESCRIPTION

640073 FALT-GEPÄCKANHÄNGER ›STALWART CARRY FOLD 1‹

449,00 €

2 IN 1

- **Aluminium-Rahmen**, silber, pulverbeschichtet
- mit **zusätzlicher verstellbarer Handdeichsel** und **Abstellhilfe**
- 20" Laufräder mit Schnellverschluss und **Aluminiumfelgen**
- max. Zuladung 45 kg
- Ablagefläche 67 x 44 x 37 cm
- mit Reflektoren
- mit Gepäcktasche (90 l) aus 600D Polyestergerewebe



FOLDABE LUGGAGE TRAILER ›STALWART CARRY FOLD 1‹

- **aluminium frame**, silver, powder-coated frame
- with **additional adjustable hand tow bar** and **parking stand**
- 20" quick release wheels with **aluminium rims**
- max. load 45 kg
- platform size 67 x 44 x 37 cm
- with reflectors
- with luggage bag (90 l) made of 600D polyester

640047 EINSPUR-GEPÄCKANHÄNGER ›STALWART SINGLE 40‹

219,00 €

7,6 kg

- **Einspur-Anhänger** mit Lenkgelenk
- universelles **Schnellspannsystem** zur Befestigung an der Hinterachse (wir empfehlen Adapter für 10 mm Festachse Art. 640077, Adapter für Nexus 8-Gang = 3/8" Gewinde Art. 640078), mit Sicherheitshaken (Art. 640127)
- werkzeuglos **faltbarer**, stabiler Stahlrahmen
- 16" Laufrad mit **Aluminiumnabe**, mit **Schnellspanner**, **Aluminiumfelge** und **Kendareifen**
- mit Flagge und Stange
- max. Zuladung 27 kg
- ebener Lochblechboden, Maße ca. 61 x 40 / 30 cm
- Außenmaße ca. (L) = 131 x (B) = 44 x (H) = 28 cm

SINGLE TRACK LUGGAGE TRAILER ›STALWART SINGLE 40‹

- **single track** trailer with steering joint
- universal **quick release system** for mounting at the rear axle (we recommend an adapter for 10 mm solid axle art. 640077, adapter for Nexus 8 speed = 3/8" thread art. 640078), with safety hooks (art. 640127)
- toolless **foldable**, stable steel frame
- 16" wheel with **aluminium** hub, with **QR**, **aluminium rim** and **Kenda** tire
- with flag and rod
- max. load 27 kg
- flat perforated plate bottom, size approx. 61 x 40 / 30 cm
- measurement outside approx. (L) = 131 x (W) = 44 x (H) = 28 cm

122522 Tasche für Einspur-Gepäckanhänger Art. 640047

U
49,90 €

- **wasserdicht**
- **universell einsetzbar** auch als Reisetasche,...
- Volumen ca. 120 Liter, ca. 60 x 38,5 x 55 cm

bag for single track luggage trailer art. 640047

- **waterproof**
- **universally applicable** also as a travel bag,...
- volume approx. 120 litres, approx. 60 x 38.5 x 55 cm

640081 Set aus Einspur-Gepäck-Fahrradanhänger Art. 640047 und Tasche Art. 122522

U
249,00 €

set of single track luggage bicycle trailer art. 640047 and bag art. 122522

640002 Adapter für Steckachsen ›Stalwart Thru‹

29,90 €

- ermöglicht die Verwendung des **Einspur-Gepäckanhängers** (Art. 640047) in Verbindung mit einer **Steckachse** mit Innengewinde (Art. 640140, 640141, 640142)
- im Polybeutel mit M-Wave Eurolochheader

adapter for thru axles ›Stalwart Thru‹

- enables usage of the **single track luggage trailer** (art. 640047) in connection with **thru axles** with internal thread (art. 640140, 640141, 640142)
- in PE bag with M-Wave eurohole header

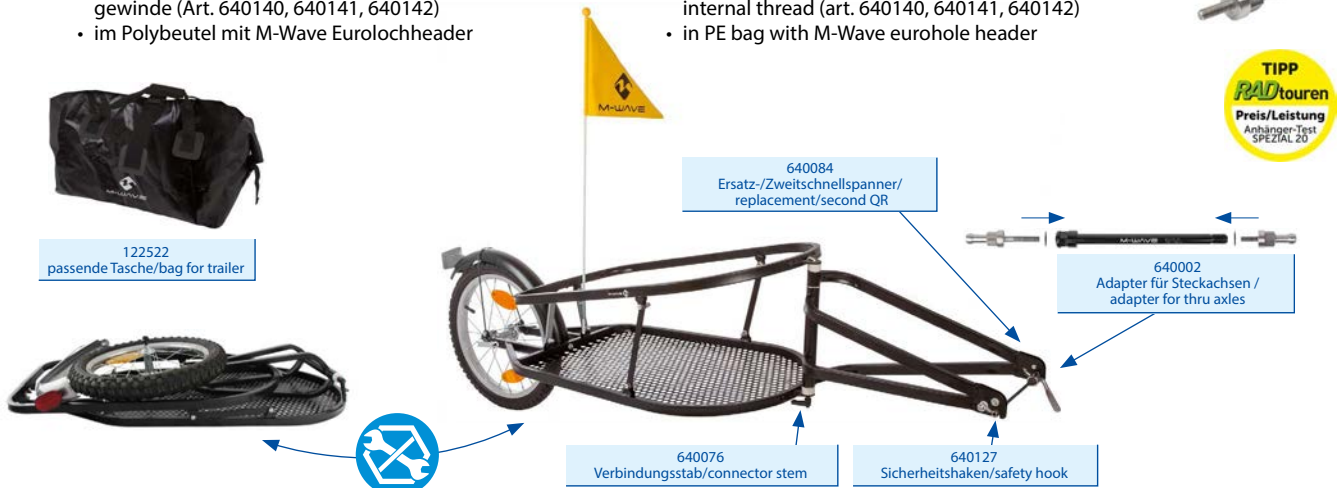

ART.-NR. BESCHREIBUNG
UVP

DESCRIPTION

640046 ^U
449,00 €
**KINDER-, GEPÄCK- UND JOGGING
FAHRRADANHÄNGER/-WAGEN**
›STALWART KID 3IN1‹

3 IN 1

- in Sekunden, **ohne Werkzeug** umbaubar vom **Fahrrad-anhänger zum Kinderwagen oder Jogger**
- **20"** Laufräder mit **Schnellverschluss** und **Sicherheitsbügel**
- **zusätzliches 12" Laufrad**
- mit feststellbarer **Handbremse**
- mit **Wegfahrsperr**
- **faltbar**
- aus **600 D** Polyestergewebe
- mit **Sicherheitsreflexdreieck** auf der Rückseite
- mit Reflektoren
- 2-sitzig mit Sicherheitsgurten und Überrollbügel
- abnehmbare Überdachung, mit Dachfenster (Art. 640016)
- mit Fliegengitter
- mit Stange und Flagge
- mit Regenschutz
- mit zusätzlichem Stauraum für Gepäck
- mit 2 Innentaschen für Kleinutensilien
- mit **Schnellverschluss** Universal-Kupplung für's Fahrrad
- geprüft gemäß EN 15918
- max. Zuladung bei Gebrauch als Jogger: 32,2 kg
- max. Zuladung als Anhänger: 20,2 kg
- Außenmaße: 61 cm (B) x 75 cm (L) x 28 cm (Sitzhöhe)

**CHILDREN, LUGGAGE AND JOGGING
BICYCLE TRAILER/VAN**
›STALWART KID 3IN1‹

- in seconds, **toolless** changeable from **bicycle trailer to baby van or jogger**
- **20"** wheels with **quick release** and **safety bow**
- **additional 12" wheel**
- with fixable **handbrake**
- with **parking brake**
- **foldable**
- made of **600 D** polyester
- with **safety reflex triangle** on the back
- with reflectors
- 2 seats with safety belts and with roll-over bar
- with detachable roof, with window (art. 640016)
- with fly-screen
- with rod and flag
- with rain protection
- with additional room for luggage
- with 2 inside pockets for small parts
- with universal **quick release** adapter for bicycle
- tested according to EN 15918
- max. load when using as jogger: 32.2 kg
- max. load as trailer: 20.2 kg
- measurement outside: 61 cm (W) x 75 cm (L) x 28 cm (seat height)



640092 ^U
519,00 €
**GEFEDERTER ALUMINIUM KINDER-
UND GEPÄCK-FAHRRADANHÄNGER**
›STALWART KID 2‹

- mit faltbarem **Aluminium-Rahmen**
- **vollgefedert**
- **20"** Laufräder mit **Schnellverschluss**
- **Aluminiumfelgen**
- aus 600D Polyestergewebe
- mit **Sicherheitsreflexdreieck** auf der Rückseite
- mit Reflektoren
- 2-sitzig mit Sicherheitsgurten
- mit Überrollbügel
- abnehmbare Überdachung (Art. 640016)
- mit Fliegengitter und Regenschutz
- mit Stange und Flagge
- mit zusätzlichem Stauraum für Gepäck
- mit 2 Innentaschen für Kleinutensilien
- mit **Schnellverschluss** Universal-Kupplung für's Fahrrad
- geprüft gemäß EN 15918
- max. Zuladung: 20 kg
- Außenmaße: 60 cm (B) x 75 cm (L) x 28 cm (Sitzhöhe)

**SUSPENSION ALUMINIUM CHILDREN
AND LUGGAGE BICYCLE TRAILER**
›STALWART KID 2‹

- with foldable **aluminium** frame
- **full suspension**
- **20"** wheels with **quick release**
- **aluminium** rims
- made of 600D polyester
- with **safety reflex triangle** on the back
- with reflectors
- 2 seats with safety belts
- with roll-over bar
- with detachable roof (art. 640016)
- with fly-screen and rain protection
- with rod and flag
- with additional room for luggage
- with 2 inside pockets for small parts
- with universal **quick release** adapter for bicycle
- tested according to EN 15918
- maximal load: 20 kg
- measurement outside: 60 cm (W) x 75 cm (L) x 28 cm (seat height)



ART.-NR. UVP **BESCHREIBUNG**

DESCRIPTION

KINDER- UND GEPÄCK-FAHRRADANHÄNGER

- **faltbar**
- **20" Räder mit Schnellverschluss**
- **Sicherheitsrahmen um die Laufräder**
- aus 600D Polyestergewebe
- mit **Sicherheitsreflexdreieck** auf der Rückseite
- mit Reflektoren
- 2-sitzig mit Sicherheitsgurten
- mit Überrollbügel
- mit abnehmbarer Überdachung (Art. 640016)
- mit Fliegengitter
- mit Stange und Flagge
- mit Regenschutz
- mit zusätzlichem Stauraum für Gepäck
- mit 2 Innentaschen für Kleinutensilien
- mit **Schnellverschluss** Universal Kupplung für's Fahrrad
- geprüft gemäß EN 15918
- max. Zuladung: 20 kg
- Außenmaße: 60 cm (B) x 75 cm (L) x 28 cm (Sitzhöhe)

CHILDREN AND LUGGAGE BICYCLE TRAILER

- **foldable**
- **20" wheels with quick release**
- **safety frame around the wheels**
- made of 600D polyester
- with **safety reflex triangle** on the back
- with reflectors
- 2 seats with safety belts
- with roll-over bar
- with detachable roof (art. 640016)
- with fly-screen
- with rod and flag
- with rain protection
- with additional room for luggage
- with 2 inside pockets for small parts
- with universal **quick release** adapter for bicycle
- tested according to EN 15918
- max. load: 20 kg
- measurement outside: 60 cm (W) x 75 cm (L) x 28 cm (seat height)

640091 ›STALWART KID EASY LIGHT‹
Aluminium-Rahmen

439,00 €

640090 ›STALWART KID EASY‹
Stahlrahmen

389,00 €

›STALWART KID EASY LIGHT‹
aluminium frame

›STALWART KID EASY‹ steel frame



Trailers

640050 ›HUNDEFAHRRADANHÄNGER‹
›STALWART PET‹

269,00 €

- **faltbar**
- 16" Räder mit **Schnellverschluss**
- aus 600D Polyestergewebe (Ersatzüberdachung Art. 640001)
- zusätzliche/s **Fronttür/Sichtfenster**
- mit **Befestigungsöse** für Hundeleine innen
- mit **Überrollbügel**
- mit Stange und Flagge
- mit Regenschutz
- mit **Schnellverschluss** Universal Kupplung für's Fahrrad
- mit faltbarer Anhängestange
- max. Zuladung: 30 kg
- Außenmaße: 43,5 cm (B) x 68 cm (L) x 51,5 cm (H), gefaltet: Höhe ca. 19 cm

DOG BICYCLE TRAILER
›STALWART PET‹

- **foldable**
- 16" wheels with **quick release**
- made of 600D polyester (replacement canopy art. 640001)
- additional **front door/window**
- with **fastening eye** inside for a dog leash
- with **roll-over bar**
- with flag and rod
- with rain protection
- with universal **quick release** adapter for bicycle
- with foldable tow bar
- max. load: 30 kg
- measurement outside: 43.5 cm (W) x 68 cm (L) x 51.5 cm (H), folded: height approx. 19 cm

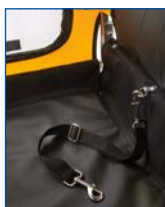

ART.-NR. BESCHREIBUNG
UVP

DESCRIPTION



STECKACHSE FÜR ANHÄNGER-KUPPLUNG
›STALWART AXLE‹



- zur **werkzeuglosen Montage von Standard Fahrrad-Anhänger-Kupplungen an 12 mm Steckachs-naben**
- **2 in 1:** durch 6 mm Distanzscheibe passend für 12 mm Steckachs-naben mit **142 mm** Einbaumaß und für **Boost-Naben** mit **148 mm** Einbaumaß
- Aluminium
- mit Schnellspanner
- auch **ohne Schnellspanner als saubere Lösung** für Steckachsen nutzbar
- mit **zusätzlichem Innengewinde** für M6-Schraube für z. B. Gepäckträgermontage
- mit zusätzlichen Unterlegscheiben zur **Einstellung der Schnellspannhebel-Position**
- auf M-Wave Eurolochkarte

640140
U
44,90 €

- **Shimano Type** (kein original Shimano Ersatzteil)
- Gewindesteigung: P1.5 x T20

640141
U
44,90 €

- **Maxle Type** (kein original Maxle Ersatzteil)
- Gewindesteigung: P1.75 x T20

640142
U
44,90 €

- **Syntace Type** (kein original Syntace Ersatzteil)
- Gewindesteigung: P1.0 x T20
- mit konischer Verbindungsscheibe

THRU AXLE FOR TRAILER MOUNT
›STALWART AXLE‹

- for **toolless mounting of standard bicycle trailer adapters at 12 mm thru axle hubs**
- **2 in 1:** by 6 mm spacer suitable for 12 mm thru axle hubs with OLD **142 mm** and for **boost hubs** with OLD **148 mm**
- aluminium
- with QR
- also usable **without QR as clean solution** for quick-release axle
- with **additional internal thread** for M6 screw for e. g. luggage rack mounting
- with additional spacers for **adjusting the QR lever position**
- on M-Wave eurohole card

- **Shimano Type** (no original Shimano spare part)
- thread pitch: P1.5 x T20

- **Maxle Type** (no original Maxle spare part)
- thread pitch: P1.75 x T20

- **Syntace Type** (no original Syntace spare part)
- thread pitch: P1.0 x T20
- with conical spacer

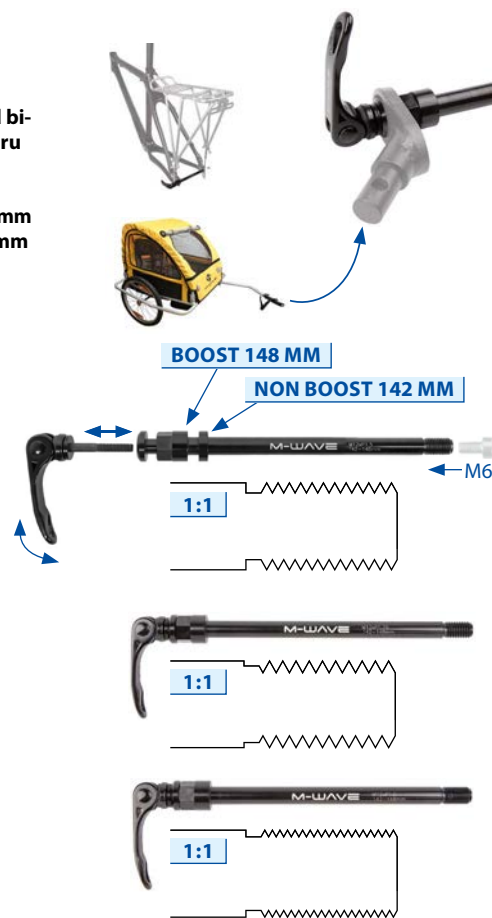

440490
U
9,90 €

SCHNELLSPANNER

- zur **Montage von Gepäckträgern an Räder:**
 - **ohne Befestigungsösen** (z. B. Rennräder)
 - mit **hinderlichen Sitzrohr- oder Kettenstreben, Ausfallenden, ...**
- passend auch für **Fahrradanhänger** Art. 640050, ...
- mit 8 je 5 mm breiten **Adapter-scheiben**
- **Aluminiumhebel**
- Länge 210 mm
- für Nabeneinbaumaß: **≥ 130 mm**
- **Einklembreite: 137 mm - 177 mm** (in 5 mm Schritten)
- auf M-Wave Eurolochkarte

QUICK RELEASE

- for **mounting of carriers to bicycles:**
 - **without mounting eyelets** (e. g. road bikes)
 - with **obstructive seat stays, chain stays, derailleur hangers, ...**
- also suitable for **bicycle trailer** art. 640050, ...
- with 8 **adapters**, each 5 mm wide
- **aluminium lever**
- length 210 mm
- OLD: **≥ 130 mm**
- **clamp width: 137 - 177 mm** (in 5 mm steps)
- on M-Wave eurohole card



640104
U
24,90 €

HUNDELEINENFÜHRUNG-STANGE ›DOG WALK‹

- stabile Feder
- Befestigung an der Sattelstütze, Sattelrohr, ...
- **Schnellspanverschluss**
- inkl. Hundeleine 92 cm
- auf M-Wave Eurolochkarte

DOG GUIDE ›DOG WALK‹

- stable spring
- attachment at the seatpost, seat tube, ...
- **quick release**
- incl. dog leash 92 cm
- with M-Wave eurohole card



ART.-NR. BESCHREIBUNG
UVP

DESCRIPTION



FAHRRAD-ABSCHLEPPSEIL
›TRAIL ROPE‹

- **Abschlepphilfe** für z. B. Kinder, Jugendliche, Erwachsene, ...
- **enorme Belastbarkeit** durch Nylonummantelung
- mit **Bungee-Gummiband** für sanftes Anfahren
- inkl. 2 Karabinerhaken und 2 Gurtbänder für einfache, werkzeuglose Montage an Sattel oder Sattelstütze des Zugrads und an Lenker, Vorbau oder Rahmendreieck des gezogenen Fahrrads
- inkl. Tasche zur Befestigung am Sattelgestell, Rahmen, ...
- im M-Wave Einzelkarton

BICYCLE TOW ROPE
›TRAIL ROPE‹

- **tow assist** for e. g. children, youths, adults, ...
- **huge resilience** due to nylon coating
- with **bungee rubber band** for gentle start
- incl. 2 carabiners and 2 webbing bands for easy, toolless mounting on saddle or seat post of the towing bike and on handlebars, handle stem or frame triangle of the towed bike
- incl. storage bag for mounting to the saddle rail, frame, ...
- in M-Wave box



640026 besonders geeignet für **schwere**
Anhängelasten (**Erwachsene**, ...)
44,90 €

especially suitable for **heavy** trailer loads (**adults**, ...)

640027 besonders geeignet für **leichtere**
Anhängelasten (**Kinder / Jugendliche**, ...)
44,90 €

especially suitable for **lighter** trailer loads (**kids / youths**, ...)

640156 **HÜFTGURT**
›TRAIL ROPE HIKING STRAP‹
13,90 €

- **einstellbarer** Hüftgurt für **universellen** Einsatz im **Ski-, Wander-**, ... Bereich
- für Abschleppseil Art. 640026/7
- ca. 40 x 1.330 mm
- auf M-Wave Eurolochkarte

HIPBELT
›TRAIL ROPE HIKING STRAP‹

- **adjustable** hipbelt for **universal** usage for **skiing, hiking**, ...
- for tow rope art. 640026/7
- approx. 40 x 1,330 mm
- on M-Wave eurohole card

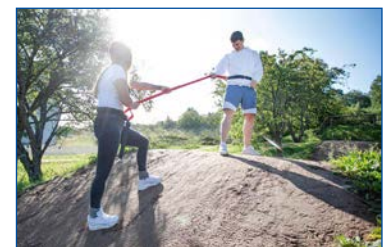

ART.-NR. BESCHREIBUNG
UVP

DESCRIPTION

659688 TRAININGSROLLE

›YOKE ´N´ROLL 65‹

199,90 €



- **Gabel** mit Schnellspanner sicher und einfach **fixierbar**
- für **26" - 29"**
- **Länge werkzeuglos an Radstand anpassbar**
- leises Laufgeräusch
- Trainingseffekt über Gangschaltung am Rad **veränderbar**
- kleiner Tritt zum leichteren Aufsteigen
- platzsparende Aufbewahrung, da zusammenschiebbar
- werkzeuglose und schnelle (De-)Montage
- im Einzelkarton

ROLL EXERCISE TRAINER

›YOKE ´N´ROLL 65‹

- **fork** can be **fixed** safely and easily with quick release
- for **26" - 29"**
- **length can be adapted to the wheel-base without tools**
- low noise emission
- training effect **can be changed** via gear shift on the bike
- mini step for easy access
- space-saving storage due to foldability
- toolless and fast (dis-)assembly
- in box



659687 ROLLENTRAINER

›YOKE ´N´ROLL 10‹

174,90 €

- 2 oversized Stahl-Standrohre mit zusätzlicher Seitenabstützung
- ergonomische **Schnelleinspann-** und Einstellgriffe
- für **26" - 29"**
- einstellbare **Magnetbremse**
- leises Laufgeräusch
- Widerstand **8-fach verstellbar mit Fernbedienung** (für Lenker Ø 22,2 - 31,8 mm)
- **zusammenklappbar**
- im Einzelkarton

ROLL EXERCISE TRAINER

›YOKE ´N´ROLL 10‹

- 2 oversized steel main tubes with additional side stability tubes
- ergonomic **quick mounting** and adjusting handles
- for **26" - 29"**
- adjustable **magnet brake**
- low noise emission
- resistance **adjustable in 8 steps with remote** (for handlebar Ø 22.2 - 31.8 mm)
- **foldable**
- in box



659686 ROLLENTRAINER

›YOKE ´N´ROLL 60‹

159,90 €

- 2 oversized Stahl-Standrohre mit Seitenabstützung
- ergonomische Einspann- und Einstellgriffe
- inkl. **Schnellspanner**
- für **26" - 29"**
- einstellbare **Magnetbremse** durch Anpressdruck
- **leises Laufgeräusch**
- **klappbar**
- im Einzelkarton

ROLL EXERCISE TRAINER

›YOKE ´N´ROLL 60‹

- 2 oversized steel main tubes with side stability tubes
- ergonomic mounting and adjusting handles
- incl. **quick release**
- for **26" - 29"**
- adjustable **magnet brake** by contact pressure
- **low noise emission**
- **foldable**
- in box



FEDERUNGSELEMENT

- **Aluminium-Körper**
- schwarze Stahlfeder
- **einstellbar**
- für Hinterbau
- Federweg 34 mm
- 650 lbs
- mit Befestigungsschrauben
- Montageverpackung

REAR SHOCK

- **aluminium** body
- black steel spring
- **adjustable**
- for rear stay
- travel 34 mm
- 650 lbs
- with fixing screws
- OEM

660431 Einbaumaß: **150 mm** x 24/24 mm

U
13,90 €

eye to eye: **150 mm** x 24/24 mm

660430 Einbaumaß: **165 mm** x 24/24 mm

14,90 €

eye to eye: **165 mm** x 24/24 mm



ART.-NR. BESCHREIBUNG
UVP

DESCRIPTION

680280 **SCHALTWERK-ADAPTER**
›ADA RANGE‹
U
9,90 €

- Aluminium
- ermöglicht die Verwendung von **wide-range Kassetten** mit großen Ritzeln, ohne dass ein Kettenwechsel mit längerem Käfig nötig ist
- besonders geeignet zum Umbau auf 1-fach Kettenradgarnitur
- auf M-Wave Eurolochkarte

REAR DERAILLEUR ADAPTER
›ADA RANGE‹

- aluminium
- **allows the installation of wide-range cassettes** with large sprockets, without the need for a chain change with a longer cage
- especially suitable for conversion to 1 speed chainwheel set
- on M-Wave eurohole card



680290 **SCHALTUNGSRÄDCHEN**
›PULLEY GUIDE‹
U
14,90 €

- **seitliche Beweglichkeit** des oberen Schaltungsradchens **optimiert die Schaltfunktion**
- 2 Stück = 1 Set (mit 2 Rädchen, 4 Schalen, 3 Hülsen, 2 Schrauben)
- 11 Zähne
- passend für 9/10-fach
- **lange Haltbarkeit** durch eingepresste Metallhülsen und hochwertige Gleitlager
- auf M-Wave Eurolochkarte

PULLEY SET
›PULLEY GUIDE‹

- **sidewise movability** of the upper pulley **optimises the shifting performance**
- 2 pieces = 1 set (with 2 pulleys, 4 cups, 3 bushes and 2 bolts)
- 11 teeth
- suitable for 9/10 speed
- **long durability** because of pressed in metal bushes and high quality slide bearings
- on M-Wave eurohole card



ÜBERSCHUH

- aus **Neopren**
- unten mit Aussparungen für Klick-Pedale
- hinten **leichter Einstieg** durch Klettverschluss
- mit **Reflexstreifen**
- paarweise auf M-Wave Eurolochkarte

SHOE COVER

- made of **neoprene**
- with recess below for clipless pedals
- **easy access** by hook and loop fastener at the back
- with **reflective tape**
- one pair on M-Wave eurohole card



715312 Größe S/M

size S/M

715313 Größe M/L

size M/L

715314 Größe L/XL

size L/XL

21,90 €



715311 **SILIKON-ÜBERSCHUH**
›TOE SHIELD‹
U
13,90 €

- **langlebiges, strapazierfähiges Silikon**
- **flexible, universelle** Passform (S-XL)
- **schützt** vor Wind und Nässe
- schnell übergestülpt mit Zuglasche
- **Verstärkung** im Zehen- und Laufbereich
- unten mit Aussparung für Schuhplatten
- paarweise auf M-Wave Eurolochkarte

SILICONE SHOE COVER
›TOE SHIELD‹

- **long-lasting, durable silicone**
- **flexible, universal fit** (S-XL)
- **protects** against wind and wetness
- quickly put on with strap
- **reinforced** at the toe and running area
- recess below for cleats
- one pair on M-Wave eurohole card



ARMLINGE UND BEINLINGE

- **leicht** und **klein**
- **trocknet** schnell
- **3D-Technologie**
- 98 % anti-UV bewirkt Temperatursenkung um bis zu 3 °C
- 80 % Polyamid, 20 % Spandex
- paarweise auf M-Wave Eurolochkarte

ARM- AND LEGWARMERS

- **light** and **small**
- fast **drying**
- **3D** technology
- 98 % anti UV lowers the temperature up to 3 °C
- 80 % Polyamid, 20 % Spandex
- one pair on M-Wave eurohole card

Armlinge

715324 Größe S/M

size S/M

715325 Größe L/XL
U
14,90 €

size L/XL

Beinlinge

715326 Größe S/M

size S/M

715327 Größe L/XL
16,90 €

size L/XL



ART.-NR. UVP **BESCHREIBUNG**

DESCRIPTION



HALS-/KOPFTUCH

- 100 % Polyester **Funktions-Microfaser**
- **nahtlos, elastisch** und **atmungsaktiv**
- Größe: ca. 24 x 48 cm
- auf M-Wave Eurolochkarte

TUBULAR HEADWEAR

- 100 % Polyester **function microfibre**
- **seamless, elastic** and **breathable**
- size: approx. 24 x 48 cm
- on M-Wave eurohole card

715179 ›Camouflage‹



›Camouflage‹



Art. 715179

715196
U ›White‹



›White‹

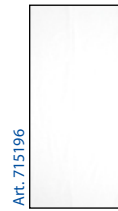

Art. 715196

715197 ›Black‹



›Black‹



Art. 715197

715206 ›Neon Yellow‹



›Neon Yellow‹



Art. 715206

715199
U ›Skull‹



›Skull‹

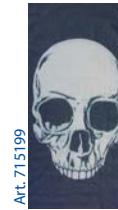

Art. 715199

715122
U ›Stripes B/W‹



›Stripes B/W‹



Art. 715116



Art. 715122

715116 ›White & Stripes‹



›White & Stripes‹



Art. 715126

715126 ›Purple Squared‹



›Purple Squared‹



Art. 715205

715205 ›Circles‹



›Circles‹



Art. 715129

715129 ›Red/Blue Squared‹



›Red/Blue Squared‹



Art. 715128

715128 ›Blue/Red Squared‹



›Blue/Red Squared‹

715204 ›Squares and Bubbles‹



›Squares and Bubbles‹

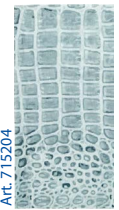

Art. 715204

715124
U ›Purple Squared‹
5,90 €



›Purple Squared‹



Art. 715124

715194
U ›M-Wave‹
4,90 €



›M-Wave‹



Art. 715194



Ab einer Stückzahl von 450 Exemplaren erstellen wir Ihnen gerne ein Angebot für Ihr individuelles Design.

At a minimum of 450 pieces we will be able to make you an offer with your individual design.

715168 **HALS-/KOPFTUCH**
›BLACK FLEECE‹
6,90 €

- 100 % Polyester **Funktions-Microfaser** mit **Fleece-Einsatz**
- **elastisch** und **atmungsaktiv**
- Größe: ca. 24 x 70 cm
- auf M-Wave Eurolochkarte

TUBULAR HEADWEAR
›BLACK FLEECE‹

- 100 % Polyester **function microfibre** with **fleece application**
- **elastic** and **breathable**
- size: approx. 24 x 70 cm
- on M-Wave eurohole card



FLEECE

ART.-NR. BESCHREIBUNG
UVP

DESCRIPTION



FAHRRADHANDSCHUHE ›ALASKA‹

BICYCLE GLOVES ›ALASKA‹

- **Windprotector** außen
- **wärmendes Fleece** innen
- **Non-Slip-Noppen** für festen Griff
- wasserabweisend
- atmungsaktiv
- mit **reflektierendem Material** von **3M Scotchlite** an den Seiten
- mit Gummizug
- nur 122 g (M)
- auf M-Wave Eurolochkarte

- **windprotector** outside
- **warming fleece** inside
- **non-slip knobs** for a firm grip
- water-repellent
- breathable
- with **reflecting material** of **3M Scotchlite** on the sides
- with rubber spring
- only 122 g (M)
- on M-Wave eurohole card



719961 U
719963 U
15,90 €

Größe M
Größe L/XL

size M
size L/XL

719862 GEL-FAHRRADHANDSCHUHE ›PROTECT SL‹

GEL BICYCLE GLOVES ›PROTECT SL‹



- **Ganzfingerhandschuh** mit **integrierten Silikon-Protektoren**
- **Geleinslagen** verringern den Druck auf den Ulnarnerv und den Karpaltunnel. Dies hilft gegen einschlafende Hände.
- Daumen und Zeigefinger mit spezieller **Auflage** zur **Touchscreenbedienung**
- **atmungsaktiv** und **waschbar**
- **elastischer Bund** mit **hochwertigem Klettverschluss**
- Größe L
- auf M-Wave Eurolochkarte

- **full finger glove** with **integrated silicone protectors**
- **gel inlays** reduce pressure on the ulnar nerve and the carpal tunnel. This helps against paraesthesia in the hands.
- thumb and forefinger with **contact area** for **touchscreen operation**
- **breathable** and **washable**
- **elastic waistband** with **high quality hook and loop fastener**
- size L
- on M-Wave eurohole card



SILICONE PROTECTION



GEL-FAHRRADHANDSCHUHE ›PROTECT HD‹

GEL BICYCLE GLOVES ›PROTECT HD‹



- **Ganzfingerhandschuh** mit **integrierten Knöchel-Protektoren**
- **Geleinslagen** verringern den Druck auf den Ulnarnerv und den Karpaltunnel. Dies hilft gegen einschlafende Hände.
- Daumen und Zeigefinger mit spezieller **Auflage** zur **Touchscreenbedienung**
- integrierte **Ausziehhilfe** aus **3M Scotchlite**
- **atmungsaktiv** und **waschbar**
- **elastischer Bund** mit **hochwertigem Klettverschluss**
- auf M-Wave Eurolochkarte

- **full finger glove** with **integrated knuckle protectors**
- **gel inlays** reduce pressure on the ulnar nerve and the carpal tunnel. This helps against paraesthesia in the hands.
- thumb and forefinger with **contact area** for **touchscreen operation**
- with **loops as take-off assistance** made of **3M Scotchlite**
- **breathable** and **washable**
- **elastic waistband** with **high quality hook and loop fastener**
- on M-Wave eurohole card



PROTECTOR

719856 Größe S
719857 Größe M
719858 U Größe L
719859 U Größe XL
18,90 €

Größe S
Größe M
Größe L
Größe XL

size S
size M
size L
size XL



GEL-FAHRRADHANDSCHUHE ›SECURE‹

GEL BICYCLE GLOVES ›SECURE‹



- neongelbe **Sicherheitsfarbe**
- **Geleinslagen** verringern den Druck auf den Ulnarnerv und den Karpaltunnel. Dies hilft gegen einschlafende Hände.
- mit **360° reflektierenden** Applikationen
- Daumen und Zeigefinger mit spezieller **Auflage** zur **Touchscreenbedienung**
- mit **Ausziehhilfe**
- außen teilweise aus **elastischem Lycra**
- **atmungsaktiv** und **waschbar**
- **elastischer Bund**
- auf M-Wave Eurolochkarte

- neon **yellow safety colour**
- **gel inlays** reduce pressure on the ulnar nerve and the carpal tunnel. This helps against paraesthesia in the hands.
- with **360° reflective** applications
- thumb and forefinger with **contact area** for **touchscreen operation**
- with **loops as take-off assistance**
- outside partly out of **elastic lycra**
- **breathable** and **washable**
- **elastic waistband**
- on M-Wave eurohole card



719890 U Größe S
719891 Größe M
719892 U Größe L
719893 U Größe XL
14,90 €

Größe S
Größe M
Größe L
Größe XL

size S
size M
size L
size XL

ART.-NR. UVP **BESCHREIBUNG**

DESCRIPTION



FAHRRADHANDSCHUHE

- Innenhand mit **Non-Slip Einlagen**
- Daumen und Zeigefinger mit spezieller **Oberfläche zur Touchscreen-bedienung**
- mit Ausziehhilfe
- **elastische Bündchen**
- waschbar und atmungsaktiv
- auf M-Wave Eurolochkarte



BICYCLE GLOVES

- rubberized inside hand with **non-slip inlay**
- thumb and forefinger with **contact area for touchscreen operation**
- with loops as take-off assistance
- **elastic cuffs**
- washable and breathable
- on M-Wave eurohole card



›FULL FINGER COMFORT‹

mit Polsterung für mehr Komfort

›FULL FINGER COMFORT‹

with padding for higher comfort



- 719610** Größe S
 - 719611** Größe M
 - 719612** Größe L
 - 719613** Größe XL
- 19,90 €

›FULL FINGER SL‹

ohne Polsterung, superleicht

›FULL FINGER SL‹

without padding, super light



- 719614** Größe S
 - 719615** Größe M
 - 719616** Größe L
 - 719617** Größe XL
- 19,90 €

FAHRRADHANDSCHUHE

- Innenhand mit **Non-Slip Einlagen**
- mit Ausziehhilfe
- **elastische Bündchen**
- waschbar und atmungsaktiv
- auf M-Wave Eurolochkarte

BICYCLE GLOVES

- rubberized inside hand with **non-slip inlay**
- with loops as take-off assistance
- **elastic cuffs**
- washable and breathable
- on M-Wave eurohole card



›HALF FINGER COMFORT‹

mit Polsterung für mehr Komfort

›HALF FINGER COMFORT‹

with padding for higher comfort



- 719640** Größe S
 - 719641** Größe M
 - 719642** Größe L
 - 719643** Größe XL
- 16,90 €

›HALF FINGER SL‹

ohne Polsterung, superleicht

›HALF FINGER SL‹

without padding, super light



- 719644** Größe S
 - 719645** Größe M
 - 719646** Größe L
 - 719647** Größe XL
- 16,90 €

ART.-NR. UVP **BESCHREIBUNG**

DESCRIPTION



GEL-FAHRRADHANDSCHUHE ›GLOVERS‹

- **Geleinlagen** verringern den Druck auf den Ulnarnerv und den Karpaltunnel. Dies hilft gegen einschlafende Hände.
- mit **Schweißeinlage**
- mit **Ausziehhilfe**
- außen teilweise aus **elastischem Lycra**
- **waschbar** und **atmungsaktiv**
- **elastischer Bund** mit **hochwertigem Klettverschluss**
- auf M-Wave Eurolochkarte
- 5 Paar im Polybeutel, farbig sortiert

GEL BICYCLE GLOVES ›GLOVERS‹

- **gel inlays** reduce pressure on the ulnar nerve and the carpal tunnel. This helps against paraesthesia in the hands.
- with **sweat band**
- with **loops as take-off assistance**
- outside partly out of **elastic lycra**
- **washable** and **breathable**
- **elastic waistband** with **high-quality hook and loop fastener**
- on M-Wave eurohole card
- 5 pairs in PE bag, assorted colours



719935 Größe M
U

size M

719936 Größe L
U

size L

719937 Größe XL
U
9,90 €

size XL

715157 FAHRRADGARAGE ›CARGO‹

35,90 €

- **extra groß**, für einspurige Lastenräder, ideal für Transportfläche vorne
- **schützt** vor Sonne, Schnee, Regen, ...
- aus **widerstandsfähigem** Tarpaulin
- Größe ca. 290 x 120 x 70 cm
- mit elastischem Bund, Klett- und Schnellverschlussbändern
- Öffnung für sehr breite Lenker, Spiegel, ...
- im Polybeutel mit Euroloch

BICYCLE GARAGE ›CARGO‹

- **extra big**, for single-track cargo bikes, ideal for front transport surface
- **protects** from sun, snow, rain, ...
- made of **resistant** tarpaulin
- size approx. 290 x 120 x 70 cm
- with elastic waistband, hook and loop fastener and quick release tapes
- opening for very wide handlebars, mirrors, ...
- in PE bag with eurohole



715164 FAHRRAD-, ROLLERGARAGE

24,90 €

- **XXL-Größe**, ca. 230 x 135 x 65 cm
- **schützt vor Sonne, Schnee, Regen, ...**
- mit **Mittverschluss**
- aus **widerstandsfähigem Tarpaulin**
- mit **Gummizug** (vorne und hinten)
- auch für **breite Lenker** und **Körbe** geeignet
- passend für alle gängigen Fahrräder, Roller, ...
- im Polybeutel mit Euroloch

BICYCLE, SCOOTER GARAGE

- **XXL size**, approx. 230 x 135 x 65 cm
- **protects from sun, snow, rain, ...**
- with **central closure**
- made of **resistant Tarpaulin**
- with **rubber straps** (front and rear)
- also suitable for **wide handlebars** and **baskets**
- suitable for all standard bicycles, scooters, ...
- in PE bag with eurohole



714841 INDOOR FAHRRADGARAGE ›VELOSOCK‹

55,00 €

- besonders geeignet für Wohnungen, Autos, ...
- ideal für 26" - 29" Fahrräder (1,6 - 2 m)
- 3D-stretch: sehr dehnbares Material, welches sich der jeweiligen Form des Fahrrads anpasst
- 90 % Polyester, 10 % Spandex
- waschmaschinenfest
- in Velosock Eurolochbox

INDOOR BICYCLE GARAGE ›VELOSOCK‹

- particularly suitable for flats, cars, ...
- ideal for 26" - 29" bicycles (1.6 - 2 m)
- 3D-stretch: very stretchable material which adapts to the shape of the bicycle
- 90 % Polyester, 10 % Spandex
- machine washable
- in Velosock eurohole box



ART.-NR. BESCHREIBUNG
UVP

DESCRIPTION



FAHRRAD-/SPORTBRILLEN
›RAYON‹

- **UV400-Schutz**
- ISO 12312-1 : 2015-12
- mit **Mikrofaser-Schutzhülle**
- mit fast **unzerbrechlichen** Polycarbonat **Sicherheitsgläsern**
- **Antikratzbeschichtung**
- in M-Wave Kunststoffbox

BIKE/SPORTS EYEWEAR
›RAYON‹

- **UV400 protection**
- ISO 12312-1 : 2015-12
- with **microfibre bag**
- with almost **unbreakable** polycarbonate **security lenses**
- **scratch proof treatment**
- in M-Wave plastic box

ISO 12312-1 : 2015-12



710169 FAHRRAD-/SPORTBRILLE
›RAYON PC ULTRA‹

59,90 €



- mit **photochromen Gläsern:** Photochrome Gläser sind Gläser, die durch ihre Schattierungstechnik mittels eines chemischen Prozesses **nachdunkeln** sobald sie der UV-Strahlung der Sonne ausgesetzt sind. Sie reagieren nicht auf künstliches Licht. Diese Gläser vereinen Mode und Komfort, bieten **Schutz** vor den schädlichen Auswirkungen der UV-Strahlung und vor Blendung. In dunkler Umgebung (Tunnel, Wald ...) hellen sie sich wieder auf.
- mit zusätzlichen **klaren, orangen, braunen Ersatzgläsern**
- **superleicht** und **extrem biegsam** durch **Grilamid-TR 90 Rahmen**
- mit **weichen** Nasenbügeln
- mit **weichen** Bügeleneinlagen
- Rahmen mattschwarz

BIKE/SPORTS EYEWEAR
›RAYON PC ULTRA‹

- with **photochromic lenses:** Photochromic lenses are the tint changing lenses that **darken** due to a chemical process when exposed to UV rays from the sun. They do not react to artificial light. These lenses combine fashion with comfort, offer **protection** from the damaging effects of UV radiation and glare. In dark surroundings (tunnel, forest ...) they will brighten again.
- with additional **clear, orange, brown spare lenses**
- **super light** and **extremely flexible** thru **Grilamid-TR 90 arms**
- with **soft** nose pads
- with **soft** temple tips
- frame matt black



710170 FAHRRAD-/SPORTBRILLE
›RAYON G4 PRO‹

44,90 €



- Rahmen aus **Polycarbonat**
- mit **auswechselbaren, rot Iridium beschichteten** Gläsern
- mit zusätzlichen dunkel **entspiegelten, orangen** und **klaren** Ersatzgläsern
- mit **seitlichem Windschutz**
- mit **anatomischer Wangenform**
- mit **weichen, verstellbaren** Nasenbügeln
- Rahmen mattschwarz

BIKE/SPORTS EYEWEAR
›RAYON G4 PRO‹

- **polycarbonate** frame
- with **exchangeable, red Iridium coated** lenses
- with additional **anti-glare, orange** and **clear** spare lenses
- with **lateral wind protector**
- with **anatomic cheek shape**
- with **soft, adjustable** nose pads
- frame matt black



710160 FAHRRAD-/SPORTBRILLE
›RAYON ONE‹

39,90 €

- Rahmen aus **Polycarbonat**
- mit **blau Iridium beschichteten** Gläsern
- mit zusätzlichen **klaren, orangen** und **dunklen** Ersatzgläsern
- mit **weichen flexiblen** Nasenbügeln
- gummierte Brillenbügel
- Rahmen schwarz / grau

BIKE/SPORTS EYEWEAR
›RAYON ONE‹

- **polycarbonate** frame
- with **blue Iridium coated** lenses
- with additional **clear, orange** and **dark** spare lenses
- with **soft flexible** nose pads
- rubber temples
- frame black / grey



ART.-NR. BESCHREIBUNG
UVP

DESCRIPTION

710162 FAHRRAD-/SPORTBRILLE

29,90 €



- ›RAYON G4‹**
- extrem guter Sonnenschutz durch **Iridium beschichtete Gläser** (austauschbar)
 - mit zusätzlichen **klaren, orangen, braunen** und **dunklen Ersatzgläsern**
 - **superleicht** und **extrem biegsam** durch **Grilamid-TR 90 Rahmen**
 - mit **weichen** Bügelendeinlagen
 - mit **weichen** Nasenbügeln
 - Rahmen mattschwarz

BIKE/SPORTS EYEWEAR

›RAYON G4‹

- perfect sun protection by exchangeable **iridium coated replacement lenses**
- with additional **clear, orange, brown** and **dark spare lenses**
- **super light** and **extremely flexible** thru **Grilamid-TR 90 arms**
- with **soft** temple tips
- with **soft** nose pads
- frame matt black



710163 FAHRRAD-/SPORTBRILLE

29,90 €



- ›RAYON IN-SIGHT‹**
- getönte Gläser **aufklappbar**
 - mit **herausnehmbarer Halterung für optische Sehhilfen**
 - mit **auswechselbaren, dunklen** Gläsern
 - mit zusätzlichen **klaren, orangen** und **braunen Ersatzgläsern**
 - mit **weichen** Bügelendeinlagen
 - mit **weichen** Nasenbügeln
 - Rahmen matt-dunkelanthrazit

BIKE/SPORTS EYEWEAR

›RAYON IN-SIGHT‹

- dark lenses **folding**
- with **removable frame for optical lenses**
- with **exchangeable, dark** lenses
- with additional **clear, orange** and **brown spare lenses**
- with **soft** temple tips
- with **soft** nose pads
- frame matt dark anthracite



FAHRRAD-/SPORTBRILLE

›RAYON FLEXI 4‹

- mit **auswechselbaren, dunklen** Gläsern
- mit **weichen** Nasenbügeln
- mit **weichen** Bügelendeinlagen

BIKE/SPORTS EYEWEAR

›RAYON FLEXI 4‹

- with **exchangeable** dark lenses
- with **soft** nose pads
- with **soft** temple tips



- 710161**
- Rahmen **matt-dunkelblau**
 - mit zusätzlichen **klaren, gelben, orangen** und **braunen Ersatzgläsern**

24,90 €

- frame **matt dark blue**
- with additional **clear, yellow, orange** and **brown spare lenses**

- 710167**
- Rahmen **mattschwarz**
 - mit zusätzlichen **klaren, orangen** und **braunen Ersatzgläsern**

24,90 €

- frame **matt black**
- with additional **clear, orange** and **brown spare lenses**

710171 FAHRRAD-/SPORTBRILLE

24,90 €



- ›RAYON F1‹**
- mit dunklen, **polarisierenden** Gläsern aus **Tri-Acetat Cellulose**
 - **mildert Blendeffekte**, Spiegelungen, Lichtreflexe
 - bessere **Wahrnehmung von Kontrasten und Farben**
 - **geringere Ermüdung** der Augen
 - mit **weichen** Bügelendeinlagen
 - Rahmen in dunkelgrau

BIKE/SPORTS EYEWEAR

›RAYON F1‹

- with dark, **polarised** glasses made of **Tri-Acetat Cellulose**
- **softens glare**, reflections, light reflections
- better **awareness of contrasts and colours**
- **less eye fatigue**
- with **soft** temple tips
- frame dark grey



ART.-NR. BESCHREIBUNG
UVP

DESCRIPTION

710168 FAHRRAD-/SPORTBRILLE

19,90 €

POLARISED LENSES

- für Brillenträger, wird über optischen Brillen getragen
- schwarzer Hochglanz-Rahmen
- seitliche Belüftung
- seitliches, getöntes Sichtfeld
- mit dunklen, **polarisierenden** Gläsern aus **Tri-Acetat Cellulose**
- **mildert Blendeffekte**, Spiegelungen, Lichtreflexe
- bessere **Wahrnehmung von Kontrasten und Farben**
- **geringere Ermüdung** der Augen

BIKE/SPORTS EYEWEAR

›RAYON FIT OVER ‹

- for spectacle wearers, to be worn over optical glasses
- black high polish frame
- lateral ventilation
- lateral tinted viewing area
- with dark, **polarised** lenses made of **Tri-Acetate Cellulose**
- **softens glare**, reflections, light reflections
- better **awareness of contrasts and colours**
- **less eye fatigue**



IRIDIUM COATED

KINDER-/FAHRRAD-/SPORTBRILLEN

- mit **weichen** Bügelendeinlagen

CHILDREN/BIKE/SPORTS EYEWEAR

- with **soft** temple tips

710165

14,90 €

- Rahmen schwarz
- dunkle Gläser

- frame black
- dark lenses



710166

14,90 €

- Rahmen rot
- Top-Sonnenschutz durch **iridiumbeschichtete** Gläser

- frame red
- top sun protection because of **iridium coated** lenses



710164 BRILLENDISPLAY

41,90 €

- aus Acrylglas
- für 6 Brillen

GLASSES DISPLAY

- made of acrylic glass
- for 6 glasses



M-WAVE
YOUR WORLD OF CYCLING

ART.-NR. UVP **BESCHREIBUNG**

DESCRIPTION

Bezahlbare Sicherheit und ein attraktiver Look müssen keine Gegensätze sein. Unsere Helme sind ein exzellentes Beispiel hierfür.

Affordable security and an attractive look do not have to be opposites. Our Helmets are an excellent example here for.

Alle Helme sind gemäß EN-1078 geprüft und verfügen über ein CE-Zeichen. Sie gewährleisten höchste Sicherheit. Unser Sortiment deckt die unterschiedlichsten Einsatzbereiche ab. Alle unsere Helme sind in einer Box verpackt.

All helmets are in accordance with EN 1078 and have a CE sign. They guarantee highest safety. Our product range covers extensive areas of use. All helmets are packed in a box.

DOWNHILL HELM ›FALL OUT‹

Maximale Sicherheit ohne Kompromisse! Dies war die Vorgabe bei der Entwicklung des ›Fall Out‹ - Helms. Als Vollvisierhelm ist er für den harten Downhilleinsatz o.Ä. konzipiert. Die spezielle **Thermoplast-Hartschale** mit den **Metallgitterversteifungen** kann auch harte Einschläge wegstecken.

DOWNHILL HELMET ›FALL OUT‹

Maximum safety without compromise! This was the main premiss for the development of the ›Fall Out‹ helmet. As a full visor helmet it was designed for hardcore usage, like downhill riding or similar. The special **thermoplast hard shell** with **metal mesh reinforcements** can even absorb hard impacts.

[according to EN 1078](#)

Belüftung: 18 Öffnungen
Gewicht: 870 g (M, mit Visier)
Komfort: herausnehmbare, **waschbare** Comfort Pads
Technologie: **Thermoplast Hartschale** mit **Metallgitterversteifung**
Visier: abnehmbares Anschraubvisier

ventilation: 18 holes
weight: 870 g (M, with visor)
comfort: removable, **washable** comfort pad
technology: **thermoplast hard shell** with **metal mesh reinforcement**
visor: detachable screw-on visor



731298 Größe M, 53 - 56 cm (Jugend/**Kind**)

size M, 53 - 56 cm (youth/**kid**)

731299 Größe L, 57 - 61 cm (Erwachsene)
134,90 €

size L, 57 - 61 cm (adult)

DOWNHILL HELM ›ALL IN 1‹

Belüftung: 17 Öffnungen
Gewicht: 650 - 710 g (M, mit Visier)
Einstellsystem: **Kopfgröße anpassbar** durch 2 verschiedene Polyester-Sets
Komfort: herausnehmbare, waschbare Comfort Pads
Technologie: **ABS Hardshell, Integralhelm**: abnehmbarer Kinnschutz
Visier: abnehmbares Anschraubvisier

DOWNHILL HELMET ›ALL IN 1‹

ventilation: 17 holes
weight: 650 - 710 g (M, with visor)
adjustment system: **adjustable to head size** by 2 different pads
comfort: removable, washable comfort pads
technology: **ABS hard shell, full face helmet**: detachable chin protector
visor: detachable screw-on visor

[according to EN 1078](#)



731140 Größe M, 54 - 58 cm

size M, 54 - 58 cm

731141 Größe L, 58 - 61 cm
74,90 €

size L, 58 - 61 cm



ART.-NR. BESCHREIBUNG
UVP

DESCRIPTION



FAHRRADHELM ›URBAN‹

Unser **Multisport-** und **Commuter-**Helm der neuesten Generation. Die zurückhaltende Form mit nach hinten heruntergezogener Schale begeistert sowohl Pendler, BMX-Fahrer als auch Inline-Skater. Durch seine Belüftungsöffnungen hilft er, einen kühlen Kopf zu bewahren.

Belüftung: 16 Öffnungen
Gewicht: 400 g (M)
Einstellsystem: Ringsystem, mit Reflex
Komfort: herausnehmbare, waschbare Comfort Pads
Technologie: **ABS Hardshell**
Visier: integriert
Sicherheit: mit Reflex-Aufkleber

ohne Helmlicht

Design: **matt black**

- 731820** Größe M, 55 - 58 cm (Jugend)
- 731821** Größe L, 59 - 61 cm (Erwachsene)

Design: **matt white**

- 731822** Größe M, 55 - 58 cm (Jugend)
 - 731823** Größe L, 59 - 61 cm (Erwachsene)
- 52,90 €

BICYCLE HELMET ›URBAN‹

according to EN 1078

Our latest generation of **multi sport** and **commuter** helmet. Commuters, BMX riders as well as inline skaters will love this reserved shape with tucked in shell on the back. It helps to keep cool through its numerous ventilation holes.

ventilation: 16 holes
weight: 400 g (M)
adjustment system: ring system, with reflex removable, washable comfort pads
comfort: ring system, with reflex removable, washable comfort pads
technology: **ABS hard shell**
visor: integrated
security: with reflex sticker

without helmet light

Design: **matt black**

- size M, 55 - 58 cm (youth)
- size L, 59 - 61 cm (adult)

Design: **matt white**

- size M, 55 - 58 cm (youth)
- size L, 59 - 61 cm (adult)



mit herausnehmbarem Helmlicht

- **6 rote LEDs**
- 3 Funktionen (Dauerlicht, 2x Blinklicht)
- inkl. Batterie (CR 2032)

Design: **matt black**

- 731824** Größe M, 55 - 58 cm (Jugend)
- 731825** Größe L, 59 - 61 cm (Erwachsene)

Design: **matt white**

- 731826** Größe M, 55 - 58 cm (Jugend)
 - 731827** Größe L, 59 - 61 cm (Erwachsene)
- 59,90 €

with removable helmet light

- **6 red LEDs**
- 3 functions (steady light, 2x flashing light)
- incl. battery (CR 2032)

design: **matt black**

- size M, 55 - 58 cm (youth)
- size L, 59 - 61 cm (adult)

Design: **matt white**

- size M, 55 - 58 cm (youth)
- size L, 59 - 61 cm (adult)



ART.-NR. UVP **BESCHREIBUNG**

DESCRIPTION

FAHRRADHELM ›ACTIVE‹

Belüftung: 11 Öffnungen
 Gewicht: 235-265 g (M, mit Visier)
 Einstellsystem: **Ringsystem**, mit Reflex
 Komfort: herausnehmbare, waschbare Pads
 Technologie: **Microshell** Oberschale
 Visier: aufsteckbares Visier
 Sicherheit: Mückenschutz, Reflex-Aufkleber

BICYCLE HELMET ›ACTIVE‹

ventilation: 11 holes
 weight: 235-265 g (M, with visor)
 adjustment system: **ring system**, with reflex
 comfort: removable, washable comfort pads
 technology: **Microshell** face plate
 visor: stick-on visor
 security: mosquito net, reflex sticker

according to EN 1078



Design: **White Carbon**

design: **White Carbon**

733128 Größe M, 53 - 57 cm (Jugend)

size M, 53 - 57 cm (youth)

733129 Größe L, 58 - 61 cm (Erwachsene)

size L, 58 - 61 cm (adult)

Design: **Blue Spots**

design: **Blue Spots**

731027 Größe M, 53 - 57 cm (Jugend)

size M, 53 - 57 cm (youth)

731028 Größe L, 58 - 61 cm (Erwachsene)

size L, 58 - 61 cm (adult)

Design: **Mamba**

design: **Mamba**

731036 Größe M, 53 - 57 cm (Jugend)

size M, 53 - 57 cm (youth)

731037 Größe L, 58 - 61 cm (Erwachsene)

size L, 58 - 61 cm (adult)

Design: **red/black/white/silver**

design: **red/black/white/silver**

731034 Größe M, 53 - 57 cm (Jugend)

size M, 53 - 57 cm (youth)

731035 Größe L, 58 - 61 cm (Erwachsene)

size L, 58 - 61 cm (adult)

Design: **White Flower**

design: **White Flower**

731032 Größe M, 53 - 57 cm (Jugend)

size M, 53 - 57 cm (youth)

731033 Größe L, 58 - 61 cm (Erwachsene)

size L, 58 - 61 cm (adult)

34,90 €



BMX HELM ›LAUNCH‹

Belüftung: 11 Öffnungen
 Gewicht: 380 g (M)
 Einstellsystem: **Ringsystem**
 Komfort: herausnehmbare, waschbare Pads
 Technologie: **ABS Hardshell**

BMX HELMET ›LAUNCH‹

ventilation: 11 holes
 weight: 380 g (M)
 adjustment system: **ring system**
 comfort: removable, washable comfort pads
 technology: **ABS hard shell**

according to EN 1078



Design: **matt black**

design: **matt black**

731184 Größe M, 54 - 58 cm

size M, 54 - 58 cm

731284 Größe L, 58 - 61 cm

size L, 58 - 61 cm

Design: **black**

design: **black**

731182 Größe M, 54 - 58 cm

size M, 54 - 58 cm

731282 Größe L, 58 - 61 cm

size L, 58 - 61 cm

Design: **white**

design: **white**

731183 Größe M, 54 - 58 cm

size M, 54 - 58 cm

731283 Größe L, 58 - 61 cm

size L, 58 - 61 cm

Design: **matt green**

design: **matt green**

731475 Größe M, 54 - 58 cm

size M, 54 - 58 cm

731485 Größe L, 58 - 61 cm

size L, 58 - 61 cm

34,90 €



ART.-NR. BESCHREIBUNG
UVP

DESCRIPTION

according to EN 1078



KINDERHELM ›JUNIOR‹

Was ist das wichtigste an einem Kinderhelm? Ganz klar die **Sicherheit**. Damit aber der Tragekomfort nicht zu kurz kommt, haben unsere Kinderhelme **zahlreiche Einstellmöglichkeiten**. Und zur Freude der Eltern macht das Helmtragen mit unseren **attraktiven Designs** auch noch Spaß!

Belüftung: 12 Öffnungen
Gewicht: **213 g (XS)**
Einstellsystem: Ringsystem mit **Reflex**
Komfort: herausnehmbare, waschbare Comfort Pads, mit zusätzlichem Ersatz-Pad-Set
Technologie: **In-Mould** Microshell
Visier: integriert
Sicherheit: Mückenschutz, Reflex-Aufkleber

Design: **Zoo**
weiß

731880 Größe XS, 48 - 54 cm

731881 Größe S, 52 - 56 cm

Design: **Race**
schwarz / gelb

731882 Größe XS, 48 - 54 cm

731883 Größe S, 52 - 56 cm

Design: **Sweet**
pink

731884 Größe XS, 48 - 54 cm

731885 Größe S, 52 - 56 cm

34,90 €

CHILDREN HELMET ›JUNIOR‹

What's the most important thing about children's helmets? **Safety**, of course. However, our children's helmets have **numerous adjustment** possibilities, so that comfort is not sacrificed. Parents will see that wearing one of our **fashionable children's helmets** is safe and also fun!

ventilation: 12 holes
weight: **213 g (XS)**
adjustment system: ring system with **reflex**
comfort: removable, washable comfort pads, with additional replacement pad set
technology: **In-Mould** Microshell
visor: integrated
security: mosquito net, reflex sticker

design: **Zoo**
white

size XS, 48 - 54 cm

size S, 52 - 56 cm

design: **Race**
black / yellow

size XS, 48 - 54 cm

size S, 52 - 56 cm

design: **Sweet**
pink

size XS, 48 - 54 cm

size S, 52 - 56 cm



REFLEX



according to EN 1078



KINDERHELM ›KID-X-S‹

Belüftung: 6 Öffnungen
Gewicht: 200 g (XS)
Einstellsystem: **Ringsystem**
Komfort: herausnehmbare, waschbare Pads
Technologie: **Microshell** Oberschale
Visier: integriert
Sicherheit: Mückenschutz
Größe: **XS, 46 - 52 cm**



730231 Design: **Smile**
neongelb

734072 Design: **Teddy**
blau

734070 Design: **Frog**
rot
24,90 €

CHILDREN HELMET ›KID-X-S‹

ventilation: 6 holes
weight: 200 g (XS)
adjustment system: **ring system**
comfort: removable, washable comfort pads
technology: **Microshell** face plate
visor: integrated
security: mosquito net
size: **XS, 46 - 52 cm**

design: **Smile**
neon yellow

design: **Teddy**
blue

design: **Frog**
red



RING SYSTEM



ART.-NR. UVP **BESCHREIBUNG**

DESCRIPTION



KINDERHELM ›KID-S‹

Belüftung: 6 Öffnungen
 Gewicht: 190 g (S)
 Einstellsystem: **Ringsystem**
 Komfort: herausnehmbare, waschbare Pads
 Technologie: **Microshell** Oberschale
 Visier: integriert
 Sicherheit: Mückenschutz
 Größe: **S, 52 - 57 cm**

CHILDREN HELMET ›KID-S‹

ventilation: 6 holes
 weight: 190 g (S)
 adjustment system: **ring system**
 comfort: removable, washable comfort pads
 technology: **Microshell** face plate
 visor: integrated
 security: mosquito net
 size: **S, 52 - 57 cm**

according to EN 1078

731125 Design: **Space**
 blau, mit **Reflexmaterial**
 24,90 €

design: **Space**
 blue, with **reflective material**



RING SYSTEM



REFLEX

REFLEX

730230 Design: **Smile**
 neongelb

design: **Smile**
 neon yellow



731004 Design: **Police**
 weiß/schwarz

design: **Police**
 white/black



731007 Design: **Soccer**
 blau

design: **Soccer**
 blue



734040 Design: **Little Devil**
 rot/gelb

design: **Little Devil**
 red/yellow



731123 Design: **Wizard**
 blau/violett/schwarz

design: **Wizard**
 blue/purple/black



731006 Design: **Curly**
 rosa

design: **Curly**
 rose



731000 Design: **Sea Land**
 blau

design: **Sea Land**
 blue



731076 Design: **Sea Land**
 gelb

design: **Sea Land**
 yellow



731001 Design: **Flower**
 pink
 23,90 €

design: **Flower**
 pink



ART.-NR. BESCHREIBUNG
UVP

DESCRIPTION

SKI

WINTER

SNOWBOARD

SKIHELM ›UNIVERSAL‹

Belüftung: 5 Öffnungen, von denen **2 verschließbar** sind
Gewicht: 475 - 505 g
Einstellsystem: **Ringsystem**
Komfort: warme, atmungsaktive **Innenpolsterung**, Kinnschutz
Technologie: **Hardshell** Oberschale aus **schlagfestem ABS-Kunststoff**
Extras: mit integriertem Skibrillenhalter, abnehmbarer Ohrenschutz

Design: **black**

733077 Größe S, 52 - 55 cm (Kinder)

733078 Größe M, 55 - 58 cm (Jugend)

733079 Größe L, 58 - 59,5 cm (Erwachsene)

Design: **white**

733034 Größe S, 52 - 55 cm (Kinder)

733035 Größe M, 55 - 58 cm (Jugend)

733036 Größe L, 58 - 59,5 cm (Erwachsene)

Design: **blue**

733004 Größe S, 52 - 55 cm (Kinder)

733005 Größe M, 55 - 58 cm (Jugend)

733006 Größe L, 58 - 59,5 cm (Erwachsene)
54,90 €

SKI HELMET ›UNIVERSAL‹

ventilation: 5 holes, **2 of them are closable**
weight: 475 - 505 g
adjustment system: **ring system**
comfort: warm, breathable **inner padding**, chin protection
technology: **Hardshell** face plate made of **shock-resistant ABS special nylon**
extras: with integrated bracket for ski glasses, removeable ear protectors

design: **black**

size S, 52 - 55 cm (children)

size M, 55 - 58 cm (youth)

size L, 58 - 59.5 cm (adult)

design: **white**

size S, 52 - 55 cm (children)

size M, 55 - 58 cm (youth)

size L, 58 - 59.5 cm (adult)

design: **blue**

size S, 52 - 55 cm (children)

size M, 55 - 58 cm (youth)

size L, 58 - 59.5 cm (adult)



780168 GEPÄCKGURT

- 8,90 €
- sehr **stabile Stahlhaken** mit **Kunststoffummantelung**
 - flacher Gummispanngurt
 - **vierfach**
 - 600 x 13 mm
 - ein **Paar** auf **M-Wave Eurolochkarte**

BUNGEE CORD

- very **strong steel hooks** with **plastic cover**
- flat bungee cord
- **quadruple**
- 600 x 13 mm
- one **pair** on **M-Wave eurohole card**

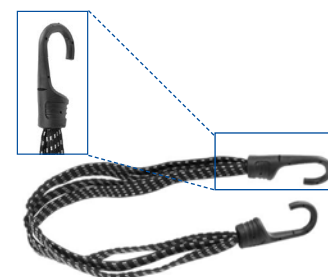



STAUB, SCHLAMM, SCHMUTZ?

Schütze dein Rad mit den Produkten der Pflegeserie GUARD. Die bereits seit 1991 speziell für Fahrräder entwickelten Pflegeprodukte haben sich weltweit bei professionellen Rennteams bewährt. Die hohe Qualität verlängert die Lebensdauer der Fahrradteile und sorgt für perfekten Leichtlauf.

- **Schmieren, Schützen, Entfetten – GUARD hat für alles die passende Lösung**
- **Produktion in der EU**
- **Höchste Qualität, die den Ansprüchen von Top-Athleten gerecht wird**

DUST, MUD, DIRT?

Protect your bike with products from the GUARD bike care series. These special care products for bikes have been developed since 1991 and are used by professional racing teams worldwide. Their high quality extends the life time of your bicycle parts and ensures smooth operation.

- **Lubrication, protection, degreasing – GUARD has the right solution**
- **Production within the EU**
- **High quality which meets the requirements of top athletes**

REINIGEN

CLEAN

FAHRRADREINIGER ›CLEAN GUARD‹

- besonders **reichhaltiger und gut haftender Schaum** zur intensiven Reinigung von starken Verschmutzungen wie Matsch, Fett und Öl
- leicht **biologisch abbaubar**
- sanft zu Lack und Oberfläche
- auch für Carbonrahmen geeignet
- Gebrauchsanweisung in BG, CS, DA, DE, EL, EN, ES, FI, FR, HR, HU, IT, NL, NO, PL, PT, RO, RU, SK, SL, SR, SV, TR, UA

880750 500 ml PE-Sprühflasche
7,90 €

880751 1000 ml Kanister zum Nachfüllen von Art. 880750
11,90 €

BIKE CLEANER ›CLEAN GUARD‹

- extra **rich and maintaining foam** for intensive cleaning from mud, grease and oil
- readily **biodegradable**
- sensitive to coating and surface
- also suitable for carbon frames
- instruction manual in BG, CS, DA, DE, EL, EN, ES, FI, FR, HR, HU, IT, NL, NO, PL, PT, RO, RU, SK, SL, SR, SV, TR, UA

500 ml PE spray bottle

1000 ml canister to refill art. 880750



880778 SCHEIBENBREMSENREINIGER ›BRAKE GUARD‹

9,90 €

- leistungsstarker **Spezialreiniger für Scheibenbremsen**
- **entfernt** schnell und vollkommen rückstandsfrei Bremsstaub sowie alle **öl-, fett- und silikonhaltigen Verschmutzungen**
- mit Punktsprühkopf für gezielten Strahl
- Gebrauchsanweisung in BG, CS, DA, DE, EL, EN, ES, FI, FR, HR, HU, IT, NL, NO, PL, PT, RO, RU, SK, SL, SR, SV, TR, UA
- 400 ml Sprühdose

DISC BRAKE CLEANER ›BRAKE GUARD‹

- high performance **special cleaner for disc brakes**
- **removes** quickly and entirely residue free brake dust, as well as **oil, grease and silicone soiling**
- with spray head for exact spraying
- instruction manual in BG, CS, DA, DE, EL, EN, ES, FI, FR, HR, HU, IT, NL, NO, PL, PT, RO, RU, SK, SL, SR, SV, TR, UA
- 400 ml spray tin



ART.-NR. BESCHREIBUNG
UVP

DESCRIPTION

SCHMIEREN

LUBRICATE

KETTENPFLEGE

›CHAIN GUARD ULTRA‹

- sehr **gute Haftfähigkeit**
- Verschleiß- und Korrosionsschutz
- bei **trockenen und nassen** Bedingungen verwendbar
- Gebrauchsanweisung in BG, CS, DA, DE, EL, EN, ES, FI, FR, HR, HU, IT, NL, NO, PL, PT, RO, RU, SK, SL, SR, SV, TR, UA

880765 50 ml PE-Flasche
5,90 €

880766 200 ml Sprühdose, mit Punktsprühkopf für gezielten Strahl
11,90 €

CHAIN CARE

›CHAIN GUARD ULTRA‹

- very **good adhesion**
- wear and corrosion protection
- to be used on **dry and wet** conditions
- instruction manual in BG, CS, DA, DE, EL, EN, ES, FI, FR, HR, HU, IT, NL, NO, PL, PT, RO, RU, SK, SL, SR, SV, TR, UA

50 ml PE bottle

200 ml spray tin, with spray head for exact spraying

2 IN 1: DRY AND WET



SPEZIALÖL

›OIL GUARD BIODEGRADABLE‹

- **Universalöl** für alle beweglichen Teile am Fahrrad
- **gute Kriechwirkung** und Korrosionsschutz
- besonders geeignet für Seilzüge, Schaltwerke, ...
- leicht **biologisch abbaubar**
- Gebrauchsanweisung in BG, CS, DA, DE, EL, EN, ES, FI, FR, HR, HU, IT, NL, NO, PL, PT, RO, RU, SK, SL, SR, SV, TR, UA

880760 100 ml PE-Flasche
4,90 €

880761 200 ml Sprühdose
• mit Punktsprühkopf für gezielten Strahl
7,90 €

SPECIAL OIL

›OIL GUARD BIODEGRADABLE‹

- **universal oil** for all movable parts of the bicycle
- **good creep effect** and corrosion protection
- especially suitable for cables, derailleurs, ...
- readily **biodegradable**
- instruction manual in BG, CS, DA, DE, EL, EN, ES, FI, FR, HR, HU, IT, NL, NO, PL, PT, RO, RU, SK, SL, SR, SV, TR, UA

100 ml PE bottle

200 ml spray tin
• with spray head for exact spraying



880779 SCHMIERMITTEL

›LUBE GUARD WHITE‹

6,90 €

- sehr **hochwertiges**, weißes **PTFE-Schmierfett**
- zum Schmieren von Lagern, Naben, Pedalen, ...
- schützt vor eindringendem Wasser und **verlängert die Lebensdauer** von Lagern
- Gebrauchsanweisung in BG, CS, DA, DE, EL, EN, ES, FI, FR, HR, HU, IT, NL, NO, PL, PT, RO, RU, SK, SL, SR, SV, TR, UA
- 125 ml Dose

LUBRICANT

›LUBE GUARD WHITE‹

- **high-quality**, white **PTFE lubricant**
- for the lubrication of bearings, hubs, pedals, ...
- excels in its high resistance against water and **provides a long life** for all bearings
- instruction manual in BG, CS, DA, DE, EL, EN, ES, FI, FR, HR, HU, IT, NL, NO, PL, PT, RO, RU, SK, SL, SR, SV, TR, UA
- 125 ml can



MONTIEREN

MOUNTING

880780 CARBON MONTAGEPASTE
›GREASE GUARD DIAMOND‹

U
14,90 €

- für Carbonteile
- auch geeignet für Stahl, Aluminium oder Titanteile in Kombination mit Carbon
- verhindert Verrutschen
- **niedrigere Klemmkräfte** (Drehmoment) reichen für gute Verbindung
- **leichteres Lösen** der Verbindung möglich
- Gebrauchsanweisung in DE, EN, ES, FR, NL
- 125 ml Dose

CARBON GRIP PASTE
›GREASE GUARD DIAMOND‹

- for carbon parts
- also suitable for steel, aluminium or titanium parts in combination with carbon
- prevents slipping
- **low clamping force** (torque) is enough for good connection
- connection **easily resolvable**
- instruction manual in DE, EN, ES, FR, NL
- 125 ml can



ART.-NR. BESCHREIBUNG
UVP

DESCRIPTION

SCHUTZ UND KONSERVIERUNG

PROTECTION AND CONSERVATION

880770 SPRÜHWACHS ›WAX GUARD‹

- 7,90 €
- erneuert und **schützt Oberflächen**
 - frischt die Farbe auf und begrenzt die Schmutzablagerung
 - verlängert die Lebensdauer
 - universell einsetzbar für Metall, Carbon, Gummi, Glattleder, Synthetik ...
 - Gebrauchsanweisung in BG, CS, DA, DE, EL, EN, ES, FI, FR, HR, HU, IT, NL, NO, PL, PT, RO, RU, SK, SL, SR, SV, TR, UA
 - 200 ml Sprühdose

SPRAY WAX ›WAX GUARD‹

- renews and **protects surfaces**
- refreshes colours and limits deposition of dirt
- increases lifetime
- for metal, carbon, rubber, smooth leather, synthetic ...
- instruction manual in BG, CS, DA, DE, EL, EN, ES, FI, FR, HR, HU, IT, NL, NO, PL, PT, RO, RU, SK, SL, SR, SV, TR, UA
- 200 ml spray tin



880775 SILIKONSPRAY ›SILICONE GUARD‹

- 10,90 €
- **schmiert, pflegt und konserviert Kontaktflächen von Kunststoff, Gummi und Metall**
 - beseitigt Knarr- und Quietschgeräusche
 - besonders für **Federgabeln** geeignet
 - mit Punktsprühkopf für gezielten Strahl
 - Gebrauchsanweisung in BG, CS, DA, DE, EL, EN, ES, FI, FR, HR, HU, IT, NL, NO, PL, PT, RO, RU, SK, SL, SR, SV, TR, UA
 - 400 ml Sprühdose

SILICONE SPRAY ›SILICONE GUARD‹

- **lubricates, maintains and conserves contact surfaces of plastic, rubber and metal**
- removes creaking and squeaking noises
- especially for **suspension forks**
- with spray head for exact spraying
- instruction manual in BG, CS, DA, DE, EL, EN, ES, FI, FR, HR, HU, IT, NL, NO, PL, PT, RO, RU, SK, SL, SR, SV, TR, UA
- 400 ml spray tin



PFLEGESET

CARE SET

880785 FAHRRAD PFLEGESET ›GUARD TEAM‹

- 27,90 €
- bestehend aus:
 - **Fahrradreiniger ›Clean Guard‹** (Art. 880750)
 - **Sprühwachs ›Wax Guard‹** (Art. 880770)
 - **Kettenpflege ›Chain Guard Ultra‹** (Art. 880765)
 - **Spezialöl ›Oil Guard Bio‹** (Art. 880760)
 - Gebrauchsanweisung in BG, CS, DA, DE, EL, EN, ES, FI, FR, HR, HU, IT, NL, NO, PL, PT, RO, RU, SK, SL, SR, SV, TR, UA
 - in M-Wave Eurolochbox

BICYCLE CARE SET ›GUARD TEAM‹

- consisting of:
 - **Bike cleaner ›Clean Guard‹** (art. 880750)
 - **Spray wax ›Wax Guard‹** (art. 880770)
 - **Chain care ›Chain Guard Ultra‹** (art. 880765)
 - **Special oil ›Oil Guard Bio‹** (art. 880760)
- instruction manual in BG, CS, DA, DE, EL, EN, ES, FI, FR, HR, HU, IT, NL, NO, PL, PT, RO, RU, SK, SL, SR, SV, TR, UA
- in M-Wave eurohole box



ART.-NR. UVP	BESCHREIBUNG	DESCRIPTION	
880595 18,90 €	FETTSPRITZE ›GREASE GUN‹ <ul style="list-style-type: none"> ergonomische Form Aluminiumkörper durchsichtiges Rohr zur Funktionskontrolle mit einer Hand zu bedienen passend für Art. 880086, ... auf M-Wave Eurolochkarte 	GREASE GUN ›GREASE GUN‹ <ul style="list-style-type: none"> ergonomic shape aluminium body clear tube for function control easy one-hand operation suitable for art. 880086, ... on M-Wave eurohole card 	
880480 122,90 €	STEUERSATZWERKZEUGE <ul style="list-style-type: none"> Montagewerkzeug für perfekten Sitz der Lagerschalen im Rahmen aus gehärtetem Spezialstahl verwendbar von 1" bis 1¼" auch passend für 1" bis 1½" im Polybeutel 	HEAD SET TOOLS <ul style="list-style-type: none"> assembly tool for perfect fit of the ahead set cups in the frame special hardened steel useable from 1" to 1¼" also suitable for 1" to 1½" in PE bag 	
880223 34,90 €	<ul style="list-style-type: none"> Werkzeug zum Einschlagen des Gabelkonus passend für 1" und 1½" im Polybeutel 	<ul style="list-style-type: none"> head set cone mounting tool suitable for 1" and 1½" in PE bag 	
880481 20,90 €	<ul style="list-style-type: none"> Steuersatz-Lagerschalen-Austreiber aus Rahmen passend für 1" und 1½" im Polybeutel 	<ul style="list-style-type: none"> head set cup remover from the frame suitable for 1" and 1½" in PE bag 	
881023 16,90 €	AHEAD-KRALLEN-EINSCHLAGHILFE <ul style="list-style-type: none"> einfaches und gerades Einschlagen der Kralle bei Aheadsystemen in 1⅞" Gabelschäfte im Polybeutel mit M-Wave-Eurolochheader 	AHEAD CLAW MOUNTING TOOL <ul style="list-style-type: none"> easy and accurate mounting of the Ahead claw in 1⅞" fork steerers in PE bag with M-Wave eurohole header 	
880482 25,90 €	ROHRABSCHNEIDEHILFE <ul style="list-style-type: none"> Rohrklemme mit Sägeführung zum Einspannen in einen Schraubstock Gabelschäfte, Sattelstützen, Lenker, ... können präzise mit einer Eisensäge gekürzt werden für Rohrdurchmesser 21 - 34 mm im Polybeutel 	TUBE CUTTING TRACK <ul style="list-style-type: none"> tube clamp with saw guide for fixing in a bench vice steerers, seat posts, handlebars, ... can be shortened precisely with a hacksaw for tube diameters from 21 - 34 mm in PE bag 	

ART.-NR. UVP **BESCHREIBUNG**

DESCRIPTION

INNENLAGER WERKZEUG

BOTTOM BRACKET TOOL

881013
U
39,90 €

- für die einfache und **genaue Montage von Pressfit Innenlagern** (BB30, BB86, BB92)
- **universell passend** für Lagerinnendurchmesser 30 mm, 24 mm (Shimano) und 24/22 mm (Sram/Truvativ GXP) über zusätzlichen Adapterring
- mit M-Wave Banderole

- for easy and **accurate mounting of pressfit bottom brackets** (BB30, BB86, BB92)
- **universally suitable** for inner bearing diameter 30 mm, 24 mm (Shimano) and 24/22 mm (Sram/Truvativ GXP) by additional adapter ring
- with M-Wave banderole

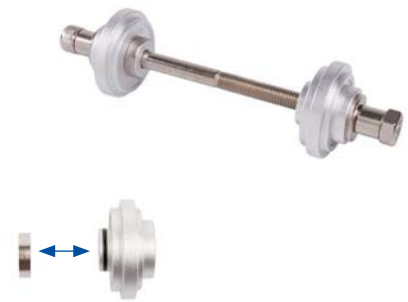

3 IN 1

881009
U
14,90 €

- ›BB Screw 1‹
- für **außenliegende Kugellagerschalen**
 - passend für 12-kerbige außenliegende Lagerschalen (z.B. **Sram Dub** BSA / Rotor BSA30 / RaceFace Cinch / Zipp Vuma, Hawk Racing BB3086, ...)
 - im Polybeutel mit Barcode-Aufkleber

- ›BB Screw 1‹
- for **outer bearing cups**
 - suitable for 12 notches external BB (e.g. **Sram Dub** BSA / Rotor BSA30 / RaceFace Cinch / Zipp Vuma, Hawk Racing BB3086, ...)
 - in PE bag with barcode sticker



881003
15,90 €

- für außenliegende Kugellagerschalen
- passend für Shimano, Truvativ, Race Face, Campagnolo
- für 1/2" Steckverbindung

- for outer bearing shells
- suitable for Shimano, Truvativ, Race Face, Campagnolo
- for 1/2" connector



881001
7,90 €

- für Shimano Innenlager (kein Original Shimano Ersatzteil)
- für 1/2" Steckverbindung und 24 mm Schlüssel
- auf M-Wave Eurolochkarte

- for Shimano bottom bracket (no original Shimano spare part)
- for 1/2" connector and 24 mm wrench
- on M-Wave eurohole card

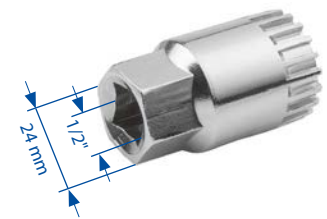

880456
U
23,90 €

E-MOTOR VERSCHLUSSRING WERKZEUG ›BB SCREW 2‹

E-MOTOR LOCKRING TOOL ›BB SCREW 2‹

- für **Montage und Demontage des Verschlussrings** des Spiders/Kettenblatts
- aus stabilem, wärmebehandeltem Stahl
- 2 in 1:
 1. Bosch Classic Line (1. Generation)
 2. Active Line (2. Generation), Performance Line, Performance Line CX
- mit M-Wave Karte

- **to mount and demount the lockring** of the spider/chainring
- made of stable, heat-treated steel
- 2 in 1:
 1. Bosch Classic Line (1. Generation)
 2. Active Line (2. Generation), Performance Line, Performance Line CX
- with M-Wave tag



3 IN 1

KURBELABZIEHER

CRANKSET REMOVER

3 in 1, für **Shimano Octalink, ISIS** und **Vierkant-Achsen**

3 in 1, for **Shimano Octalink, ISIS** and **square axles**

880555 auf M-Wave Eurolochkarte

on M-Wave eurohole card

880547 im Polybeutel
7,90 €

in PE bag



ART.-NR. UVP	BESCHREIBUNG	DESCRIPTION
-----------------	--------------	-------------

881085 **PRESSE FÜR HYDRAULIK-LEITUNGEN ›PRESS IT‹**
 U
 49,90 €

- **CNC-gefräste Montagehilfe**
- zum einfachen und geraden Einpressen von Leitungsverbindungen
- drehbarer Leitungsadapter, passend für **Shimano, Magura, Hayes, Tektro, Promax**, etc.
- auf M-Wave Eurolochkarte

HYDRAULIC PRESS ›PRESS IT‹

- **CNC machined installation aid**
- for easy and straight pressfitting of hydraulic line connections
- turnable adapter, for **Shimano, Magura, Hayes, Tektro, Promax**, etc.
- on M-Wave eurohole card

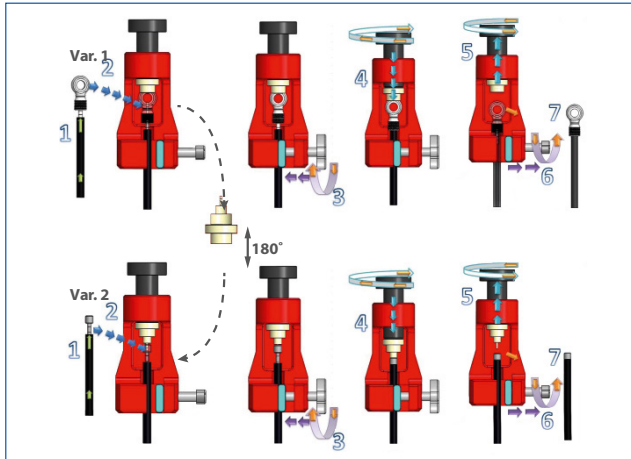

880458 **KASSETTENZAHNKRANZ-ABZIEHER ›TW-D1‹**
 U
 6,90 €

3 IN 1

- mit **5 mm Führungsstift** für Schnellspannachsen
- abnehmbarer Adapter für Naben mit **12 mm Steckachse**
- für Shimano Hyperglide-Kassette
- für Sram XD Drive
- zur (De-)Montage von Shimano **Centerlock Bremscheiben (QR9)** (kein Original Shimano/Sram Ersatzteil)
- für 1/2" Steckverbindung oder 24 mm Schlüssel
- im Polybeutel mit M-Wave Euroloch-header

CASSETTE SPROCKET REMOVER ›TW-D1‹

- with **5 mm guide pin** for quick release axles
- removable adapter for hubs with **12 mm thru axle**
- for Shimano hyperglide cassette
- für Sram XD Drive
- for (dis-)mounting of Shimano **centerlock discs (QR9)** (no original Shimano/Sram spare part)
- for 1/2" drive or 24 mm wrench
- in PE bag with M-Wave eurohole header

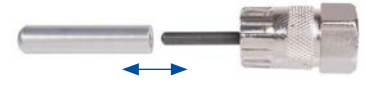

880446 **KETTENMESSLEHRE**
 U
 4,90 €

- schnelles und einfaches Messen des Verschleißes
- auf M-Wave Eurolochkarte

CHAIN CHECKER

- quick and easy measurement of the wearout
- on M-Wave eurohole card

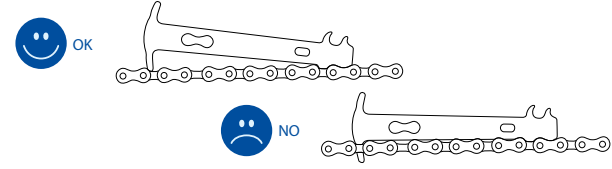

880031 **KETTENNIETDRÜCKER ›PIN PUSHER PAUL‹**
 U
 10,90 €

- **hochwertige Ausführung**
- kunststoffummantelter **Non-Slip** Griff
- mit **Kettenhalter** zur einfacheren Montage
- **Ersatzstift** durch **drehbaren** Nietstift
- Ersatzstift (Art. 880032) separat erhältlich
- auf M-Wave Eurolochkarte

CHAIN RIVETING TOOL ›PIN PUSHER PAUL‹

- **high quality**
- plastic coated **non-slip** handle
- with **chain keeper** for easier mounting
- **replacement bolt** by **turnable** riveting bolt
- replacement bolt (art. 880032) separately available
- on M-Wave eurohole card

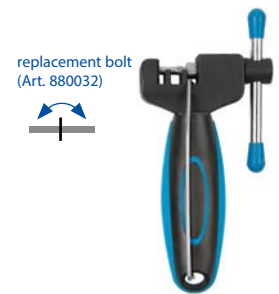

ART.-NR. UVP **BESCHREIBUNG**

DESCRIPTION

- 880358** **NIPPELDREHER-BIT**
 U
 5,90 €
- Schlitznippeldreher-Bit mit Pin für **Elektroschrauber**
 - ermöglicht ein **superschnelles und einfaches Ein-/Aussteichen**
 - aus stabilem Carbonstahl, verchromt
 - Montageverpackung

- SPOKE WRENCH BIT**
- slit nipple wrench bit with pin for **electric screwdriver**
 - provides **extremely fast and easy wheel set manufacturing**
 - carbon steel, c.p.
 - OEM

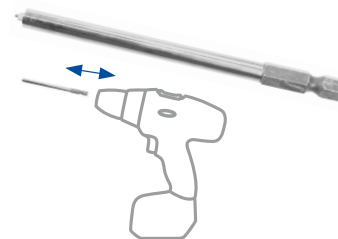

- 880266** **DIGITALER DREHMOMENT-SCHLÜSSEL ›TORQUE ALARM‹**
 U
 249,00 €
- **sehr hochwertige** Ausführung
 - genaue Einteilung von **3 - 60 Nm**
 - **2% Genauigkeit**
 - verschiedene Messeinheiten einstellbar
 - mit **Signalton** beim Erreichen des eingestellten Drehmoments
 - **umschaltbare** Knarre (3/8") mit **Richtungswechsel**
 - **Drehmomentauslösung in beide Richtungen**
 - 3/8" Adapter für Bits
 - Bits mit 3/4/5/6/8/10 mm Innensechskant
 - T 25, T 30 und T 40 Vielzahn Schlüssel
 - Kreuzschraubendreher
 - 8/9/10/11/12/13/14/15 mm Nüsse
 - inkl. Batterie (1 x AAA)
 - im Hardcase mit M-Wave Banderole

- DIGITAL TORQUE WRENCH ›TORQUE ALARM‹**
- **very high quality**
 - exact scale from **3 - 60 Nm**
 - **2% accuracy**
 - various measure units adjustable
 - with **acoustic signal** by achievement of the adjusted torque
 - **reversible ratchet** (3/8") with **changeable direction**
 - **torque release in both directions**
 - 3/8" adapter for bits
 - hex bits 3/4/5/6/8/10 mm allen key
 - T 25, T 30 and T 40 star screwdriver
 - Phillips screwdriver
 - 8/9/10/11/12/13/14/15 mm nuts
 - incl. battery (1 x AAA)
 - in hardcase with M-Wave banderole



- 880291** **DREHMOMENTSCHLÜSSEL ›TW-4/24‹**
 U
 85,90 €
- **hochwertige** Ausführung
 - genaue Einteilung von **4 - 24 Nm**
 - Einstellung **fixierbar**
 - **umschaltbare** Knarre (1/4") mit **Richtungswechsel**
 - Bits mit 3/4/5/6/8 mm Innensechskant, T 25 und T 10 Vielzahn Schlüssel
 - mit **anatomisch geformtem 2-Komponenten Griff**
 - im Hardcase mit M-Wave Banderole

- TORQUE WRENCH ›TW-4/24‹**
- **high quality**
 - exact scale from **4 - 24 Nm**
 - torque value **fixable**
 - **reversible ratchet** (1/4") with **changeable direction**
 - hex bits 3/4/5/6/8 mm allen key, T 25 and T 10 star screwdriver
 - with **anatomically shaped 2 components grip**
 - in hardcase with M-Wave banderole



- 880293** **DREHMOMENTSCHLÜSSEL ›TW-3/10‹**
 U
 16,49 €
- **3 - 10 Nm**
 - Bits mit 3/4/5/6 mm Innensechskant, T 25 Vielzahn Schlüssel, Kreuzschraubendreher
 - in M-Wave Blisterverpackung

- TORQUE WRENCH ›TW-3/10‹**
- **3 - 10 Nm**
 - hex bits 3/4/5/6 mm allen key, T 25 star screwdriver, Phillips screwdriver
 - in M-Wave blister packaging



ART.-NR. UVP	BESCHREIBUNG	DESCRIPTION	
<p>880264 7,90 €</p>	<p>BIT-SET ›ADAPT 1/4‹</p> <ul style="list-style-type: none"> mit Adapter von ¼" Vierkant auf ¼" Sechskant Dadurch können Sie alle gängigen ¼" Sechskantbits mit unserem Drehmomentschlüssel verwenden. Bits mit 2,5/3/4/5/6 mm Innen-sechskant T 10/20/25 Vielzahnschlüssel Kreuzschraubendreher 1/2 in M-Wave Blisterverpackung 	<p>BIT SET ›ADAPT 1/4‹</p> <ul style="list-style-type: none"> with adapter from ¼" square to ¼" hex This allows you to use all current ¼" hex bits with our torque wrench. hex bits 2.5/3/4/5/6 mm allen key T 10/20/25 star screwdriver Phillips screwdriver 1/2 in M-Wave blister packaging 	
<p>880267 19,90 €</p>	<p>REIFENFLICK-SET ›TUBELESS FIX‹</p> <ul style="list-style-type: none"> in hochwertigem Aluminium Gehäuse 2 Funktionen: Reifen Reibahle und Einführwerkzeug verschieden dicke Streifen für kleine und große Löcher: 5 x Ø 1,5 mm 3 x Ø 3,5 mm Gehäuse dient bei Verwendung als Hebel auf M-Wave Eurolochkarte 	<p>TUBELESS REPAIR KIT ›TUBELESS FIX‹</p> <ul style="list-style-type: none"> in high quality aluminium case 2 functions: tire reamer and insert tool stripes in different widths for small and big holes: 5 x Ø 1.5 mm 3 x Ø 3.5 mm case useable as lever on M-Wave eurohole card 	
<p>880365 8,90 €</p>	<p>TUBELESS REPAIR KIT ›TUBELESS FIX ECO‹</p> <ul style="list-style-type: none"> mit Reibahle und Einführungs-werkzeug verschieden dicke Streifen für kleine und große Löcher 5 x Ø 1,5 mm 5 x Ø 3,5 mm in M-Wave Kunststoff-Box 	<p>TUBELESS REPAIR KIT ›TUBELESS FIX ECO‹</p> <ul style="list-style-type: none"> tire reamer and insert tool stripes in different widths for small and big holes 5 x Ø 1,5 mm 5 x Ø 3,5 mm in M-Wave plastic box 	
<p>880368 2,99 €</p>	<p>FLICKZEUGSET</p> <p>in Kunststoff-Box, bestehend aus:</p> <ul style="list-style-type: none"> 2 Reifenheber 1 Tube Vulkanisierlösung (10 ml / 6,5 g) 2 Flicken Ø 26 mm 4 Flicken 25 x 34 mm 1 Flicken 34 x 51 mm 1 Sandpapier 1 Ventilschlauch Arbeitsanleitung 	<p>REPAIR KIT</p> <p>set in a box, consisting of:</p> <ul style="list-style-type: none"> 2 tire levers 1 tube solution (10 ml / 6.5 g) 2 patches Ø 26 mm 4 patches 25 x 34 mm 1 patch 34 x 51 mm 1 sand paper 1 valve tube instruction 	
<p>880002 11,90 €</p>	<p>REIFENMONTIERZANGE</p> <ul style="list-style-type: none"> Montagehilfe, besonders geeignet für schwierige Reifen-/Felgen-Kombinationen besonders effektiv durch große Hebelwirkung aus hochwertigem Kunststoff auf M-Wave Eurolochkarte 	<p>WHEEL MOUNT PLIERS</p> <ul style="list-style-type: none"> installation aid, particularly suitable for complex tire to wheel combinations particularly effective with great leverage made of high quality plastic on M-Wave eurohole card 	

ART.-NR. BESCHREIBUNG
UVP

DESCRIPTION

880390 REIFENHEBER

6,90 € / pair

- **hochwertiger** Kunststoff: **stabil** und **schonend**
- **extra lange** Ausführung
- fast **unzerbrechlich**
- paarweise auf M-Wave Eurolochkarte

TIRE LEVERS

- **high quality** plastic: **stable** and **gentle**
- **extra long** version
- almost **unbreakable**
- one pair on M-Wave eurohole card



880262 REIFENHEBER >TP-L1<

2,99 € / set

- aus stabilem Kunststoff
- 1 Set = **3 Stück**
- mit **2-fach Haken** zum Einhängen in die Speichen
- auf M-Wave Eurolochkarte

TIRE LEVER >TP-L1<

- made of stable plastic
- 1 set = **3 pieces**
- with **double hook** for fixation at the spokes
- on M-Wave eurohole card



880253 GEWINDESCHNEIDE-SET
>CUT 10<

62,90 €

10-teilig

- M 4 x 0,70
- M 5 x 0,80
- M 6 x 1,00
- M 8 x 1,25
- M 10 x 1,00
- Pedalgewindeschneider 9/16" (links & rechts)
- Pedalgewindeschneider 1/2" (links & rechts)
- inkl. Klemmdrehgriff
- in Tasche mit M-Wave Banderole

THREAD CUTTING SET
>CUT 10<

10-piece

- M 4 x 0.70
- M 5 x 0.80
- M 6 x 1.00
- M 8 x 1.25
- M 10 x 1.00
- pedal thread cutter 9/16" (left & right)
- pedal thread cutter 1/2" (left & right)
- incl. turning bracket
- in bag with M-Wave banderole



880050 FAHRRAD-WERKZEUGKOFFER
>PORTABLE CLINIC<

134,90 €

"alles in einem", 43-teilig

- Flickzeug
- 2 Flach- und 2 Kreuzschraubenzieher
- Zahnkranzabzieher
- kleiner Schraubenzieher (für die Schaltungseinstellung)
- Gabelschlüssel 8/10 mm
- Zahnkranzschlüssel mit Kette
- Steuersatzschlüssel 30/32 + 36/40 mm
- Konusschlüssel 13/15 + 14/16 mm
- Kurbelabzieher
- Nippelspanner 10/11/12/13/14/15G
- Innensechskant-Schlüsselset 2/2,5/3/4/5/6 mm (bei 4/5/6 mm Innensechskant-Kugellende)
- verstellbarer Tretlagerschlüssel
- Pedalarmschlüssel 15/16 + 15/17 mm
- Tretlagerwerkzeug
- verstellbarer Gabelschlüssel, 0 - 21 mm
- Kettennietdrücker
- 8 mm Innensechskantschlüssel (für Kurbelabzieher)
- 3 Reifenheber
- 6/8/9/10 mm Sechskant



BICYCLE TOOL CASE
>PORTABLE CLINIC<

"all in one", 43 pcs.

- repair kit
- 2 flat and 2 Phillips screwdriver
- freewheel remover
- small screwdriver (for derailleur adjustment)
- forged open-ended wrench 8/10 mm
- freewheel turner with chain whip
- headset wrench 30/32 + 36/40 mm
- cone wrenches 13/15 + 14/16 mm
- cotterless crankarm extractor
- spoke adjuster 10/11/12/13/14/15G
- allen key set 2/2.5/3/4/5/6 mm (at 4/5/6 mm ball end)
- adjustable bottom bracket tool
- pedal wrench 15/16 + 15/17 mm
- cartridge bottom bracket tool
- adjustable forged steel wrench, 0 - 21 mm
- chain riveting tool
- 8 mm allen key wrench (for crankarm removal)
- 3 tire levers
- 6/8/9/10 mm hexagonal



ART.-NR. UVP	BESCHREIBUNG	DESCRIPTION	
880920 U 20,90 €	MINI-FALTWERKZEUG ›LITTLE 15‹ 15 Funktionen <ul style="list-style-type: none"> • 2/2,5/3/4/5/6/8 mm Innensechskantschlüssel • Kreuz- und Schlitzschraubendreher • Kettennietdrücker • Speichenschlüssel 3,2/3,3/3,5/4 • T 25 Vielzahnschlüssel • auf M-Wave Eurolochkarte 	MINI FOLDING TOOL ›LITTLE 15‹ 15 functions <ul style="list-style-type: none"> • 2/2.5/3/4/5/6/8 mm allen key • Phillips and flat type screwdriver • chain riveting tool • spoke adjuster 3.2/3.3/3.5/4 • T 25 star screwdriver • on M-Wave eurohole card 	

880955 U 15,90 €	MINI-FALTWERKZEUG ›LITTLE 12‹ 12 Funktionen Werkzeuge aus Chrom-Vanadium-Stahl <ul style="list-style-type: none"> • 2/3/4/5/6 mm Innensechskant • T 25 Vielzahnschlüssel • 2 Schraubenzieher • 4 Nippelspanner • nur 78 g • auf M-Wave Eurolochkarte 	MINI FOLDING TOOL ›LITTLE 12‹ 12 functions Tools made of chrome vanadium steel <ul style="list-style-type: none"> • 2/3/4/5/6 mm allen key • T 25 star screwdriver • 2 screwdrivers • 4 spoke adjusters • only 78 g • on M-Wave eurohole card 	 
------------------------	---	--	---

408231 U 19,90 €	LENKERZUSATZGRIFF ›BE TOOL‹ <ul style="list-style-type: none"> • Aluminium • mattschwarz • Werkzeugset im Inneren mit 15 Funktionen: 4/5/6/8 mm Innensechskantschlüssel T 25 Vielzahnschlüssel 14G/0,136" Speichenschlüssel Kreuz-/Schlitzschraubendreher 8/9/10 mm Ring-/Maulschlüssel Kettennietdrücker 2 Reifenheber • in M-Wave Blisterverpackung 	BAR END ›BE TOOL‹ <ul style="list-style-type: none"> • aluminium • matt black • tool set inside with 15 functions: 4/5/6/8 mm allen key T 25 star screwdriver 14G/0.136" spoke wrench Phillips/flat screwdriver 8/9/10 mm round wrench chain riveting tool 2 tire levers • in M-Wave blister packaging 	<p style="text-align: right;">according to ISO 4210</p> 
------------------------	---	--	---

880941 U 7,90 €	MINI-FALTWERKZEUG <ul style="list-style-type: none"> • Carbon-Seitenteile • 2/3/4/5/6 mm Innensechskant • 1 Schlitzschraubendreher • 1 Kreuzschraubendreher • nur 59 g • inkl. Tasche mit Gürtelschlaufe • auf M-Wave Eurolochkarte 	MINI FOLDING TOOL <ul style="list-style-type: none"> • Carbon sides • 2/3/4/5/6 mm allen key • 1 flat screwdriver • 1 Phillips screwdriver • only 59 g • incl. pocket with belt loop • on M-Wave eurohole card 	  
-----------------------	--	---	--

CARBON

59 g

ART.-NR. BESCHREIBUNG
UVP

DESCRIPTION

880069 ZENTRIERSTÄNDER

U
137,00 €

FOLD

- für 12"-29" Laufräder
- **selbsttätiges Mittigstellen** beim Einspannen des Laufrades
- simultane Kontrolle des **Höhen- und Seitenschlages** möglich
- **Aluminium/Stahl**
- **zusammenklappbar**
- hochwertige Verarbeitung

WHEEL TRUING STAND

- for 12"-29" wheels
- clamps the wheel **centric** by **self-acting**
- simultaneous control of the **height and side tolerances** possible
- **aluminium/steel**
- **foldable**
- high-grade manufacturing



881041 MONTAGESTÄNDER
TOP ASSIST 2<

334,90 €

E

E-BIKES
UP TO
50 KG

360°

- **Aluminium**
- mit **Aluminium Drehkopfverzahnung**
- nur 4,8 kg
- in Sekunden zusammenleg- und aufbaubar
- max. Belastung: **50 kg**
- **Klemme 360° drehbar**
- universell auf Rohrdurchmesser einstellbar
- **höhenverstellbar**
- **stabiler** Stand
- im M-Wave Einzelkarton

BICYCLE REPAIR STAND
TOP ASSIST 2<

- **aluminium**
- with **aluminium turning head interlock**
- only 4.8 kg
- foldable and defoldable in seconds
- max. load: **50 kg**
- **clamp 360° turnable**
- universally adjustable to tube diameter
- **height adjustable**
- **stable** stand
- in M-Wave box

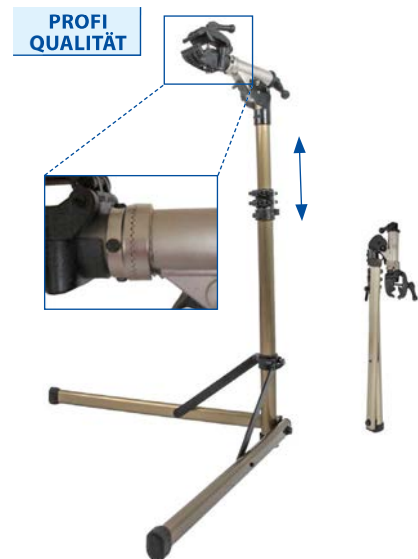

881042 ERSATZEINSATZ FÜR KLEMME

9,90 €

- für Montageständer Art. 881041, ...
- 2 Klemmeinsätze mit Befestigungsclips
- Set im Polybeutel

REPLACEMENT CLAMP INSERT

- for assembly stand art. 881041, ...
- 2 clamp inserts with mounting clips
- set in PE bag



881047 MONTAGE-/
REPARATURSTÄNDER

U
124,90 €

360°

- **faltbar** und **aufstellbar** in **Sekunden**
- **höhenverstellbar**
- Arbeitshöhe ca. 90 - 160 cm
- **Arm 360° drehbar** und **verstellbar**
- mit **Kunststoffablageschale (Art. 880068)**
- mit Kratzschutz-Klemmeinsatz (Art. 881049)
- im M-Wave Einzelkarton

UNIVERSAL
WORKSTATION

- **foldable** and **defoldable** in **seconds**
- **height adjustable**
- working height approx. 90 - 160 cm
- **arm 360° turnable** and **adjustable**
- with **plastic tool tray (art. 880068)**
- with scratch protection clamping (art. 881049)
- in M-Wave box



ART.-NR. UVP	BESCHREIBUNG	DESCRIPTION
881048 U 59,90 €	WAND-/WERKBANK-MONTAGE-/ REPARATURSTÄNDER ›TOP ASSIST W&T‹ <ul style="list-style-type: none"> • für Wand- und Tischmontage • Schnellverschluss-Klemme und Arm 360° drehbar • mit Kratzschutz-Klemmeinsatz (Art. 881049) • mit Befestigungsmaterial • im M-Wave Einzelkarton 	WALL/WORKBENCH UNIVERSAL WORKSTATION ›TOP ASSIST W&T‹ <ul style="list-style-type: none"> • for wall and table mounting • QR clamp and arm 360° turnable • with scratch protection clamping (art. 881049) • with mounting material • in M-Wave box



EDELSTAHLSCHRAUBEN	STAINLESS STEEL SCREWS
<ul style="list-style-type: none"> • mit Innensechskantkopf nach DIN 912 • 50 Stück in M-Wave Kunststoffbox 	<ul style="list-style-type: none"> • with allen key head acc. to DIN 912 • 50 pcs in M-Wave plastic box

• **881990** M5 x 12 mm

M5 x 12 mm

• **881991** M5 x 16 mm

M5 x 16 mm

9,90 € / box



881987 • M3 x 8 mm
0,09 € • mit Innensechskantsenkopf

• M3 x 8 mm
• with allen key countersunk head



EDELSTAHLMUTTERN	STAINLESS STEEL NUTS
<ul style="list-style-type: none"> • selbstsichernd nach DIN 985 • 100 Stück in M-Wave Kunststoffbox 	<ul style="list-style-type: none"> • self-locking acc. to DIN 985 • 100 pcs in M-Wave plastic box

• **881996** M5

M5

• **881997** M6

M6

10,90 € / box

EDELSTAHLUNTERLEGSCHIEBEN	STAINLESS STEEL WASHERS
<ul style="list-style-type: none"> • für M5 Schrauben • Innendurchmesser ca. 5,2/6,2 mm • Außendurchmesser 10/12 mm • 100 Stück in M-Wave Kunststoffbox 	<ul style="list-style-type: none"> • for M5 screws • inner diameter approx. 5.2/6.2 mm • outer diameter 10/12 mm • 100 pcs in M-Wave plastic box

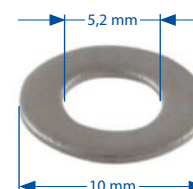

BIKE-SCHLÜSSELANHÄNGER	BIKE KEY FOB
<ul style="list-style-type: none"> • Aluminium • mit M-Wave Logo • hellblau • im Polybeutel 	<ul style="list-style-type: none"> • aluminium • with M-Wave logo • light blue • in PE bag



NOTIZEN

NOTES



Reflex Products	Reflex-Artikel Reflex Products Seite page 04	Mirrors	Spiegel Mirrors Seite page 74	Rims	Felgen Rims Seite page 126	Pumps	Pumpen Pumps Seite page 164
Bags	Taschen Bags Seite page 08	Chains	Ketten Chains Seite page 77	Head sets & Accessories	Steuersätze & Zubehör Head sets & Accessories Seite page 127	Tire Accessories	Reifen-Zubehör Tire Accessories Seite page 167
Saddle Covers	Satteldecken Saddle Covers Seite page 28	Pedals	Pedale Pedals Seite page 81	Handlebars & Accessories	Lenker & Zubehör Handlebars & Accessories Seite page 132	E-Bike Protection Covers	E-Bike Schutzhüllen E-Bike Protection Covers Seite page 171
Lamps & Brackets	Lampen & Halter Lamps & Brackets Seite page 29	Hub Accessories	Nabenzubehör Hub Accessories Seite page 92	Grips	Griffe Grips Seite page 140	Trailers	Anhänger Trailers Seite page 172
Locks	Schlösser Locks Seite page 41	Bottles	Trinkflaschen Bottles Seite page 94	Bells	Glocken Bells Seite page 146	Roll Exercise Trainer	Rollentrainer Roll Exercise Trainer Seite page 179
Computers	Computer Computers Seite page 55	Chainwheel Sets	Kettenradgarnituren Chainwheel Sets Seite page 103	Side Stands & Bike Holder	Parkstützen & Fahrradhalter Side Stands & Bike Holder Seite page 150	Bike/Sportswear	Bekleidung Bike/Sportswear Seite page 180
Saddles	Sättel Saddles Seite page 59	Bottom Brackets	Innenlager Bottom Brackets Seite page 107	Baskets	Körbe Baskets Seite page 155	Sunglasses	Brillen Sunglasses Seite page 185
Seat Tube Clamps	Sattelklemmen Seat Tube Clamps Seite page 66	Brakes & Accessories	Bremsen & Zubehör Brakes & Accessories Seite page 109	Carriers	Gepäckträger Carriers Seite page 159	Helmets	Helme Helmets Seite page 188
Seat Posts	Sattelstützen Seat Posts Seite page 67	Mudguards	Schutzbleche Mudguards Seite page 119	Head Lamps & Rear Lights	Scheinwerfer & Rücklichter Head Lamps & Rear Lights Seite page 161	Bicycle Care & Tools	Pflegemittel & Werkzeuge Bicycle Care & Tools Seite page 194

messingschlager

Haßbergstr. 45
96148 Baunach - Germany
Tel.: +49 (0) 95 44 9444 - 0
www.m-wave-bike.com



Der Prospekt richtet sich nur an Kunden außerhalb Deutschlands.