



M-WAVE

YOUR WORLD OF CYCLING



YOUR WORLD OF CYCLING

M-Wave, das sind erstklassige Produkte für alle Radfahrer, die insbesondere Funktion im Fokus haben. M-Wave bietet ein vollumfängliches Sortiment für Radfahrer mit technischem Anspruch, die auf der Suche nach innovativen und qualitativ wertigen Materialien sind.

Hinter M-Wave steht Entwicklung und Design aus Deutschland, eine Qualitätskontrolle auf höchstem Niveau, jahrelange praktische Erfahrung und das enorme Know-how von Europas größtem Importeur von Zweiradzubehör.

Das M-Wave Sortiment umfasst über 1000 Artikel mit überdurchschnittlichen Händlermargen, die weltweit in mehr als 70 Ländern verkauft werden.

M-Wave - these are first-class products for all cyclists who have a particular focus on function. M-Wave offers a complete range for cyclists with technical demand who are looking for innovative and quality materials.

M-Wave stands for development and design from Germany, a quality control at the highest level, many years of practical experience and the enormous know-how of Europe's largest importer of bicycle accessories.

The M-Wave range includes over 1000 items with above-average retail margins, sold in more than 70 countries worldwide.



ALL A CYCLIST NEEDS

Egal ob Regen oder Sonnenschein, Tag oder Nacht, M-Wave bietet die passende Lösung.

Whether rain or sunshine, day or night, M-Wave offers the right solution.



MAKE CYCLISTS HAPPY

Innovative Produkte, praktisches Design, bodenständige Preise: „Be happy“

Innovative products and functional designs at a fair price-ride with a smile!



QUALITY MATERIALS

M-Wave Produkte entsprechen den höchsten Qualitäts- und Fertigungsstandards.

M-Wave products meet with the highest quality and manufacturing standards.

PACKAGING DESIGN

Helles, leuchtendes Blau. Damit ziehen die konsequent einheitlich gestalteten M-Wave-Verpackungen die Aufmerksamkeit der Kunden auf sich.

Die optimierte Gestaltung der Verpackungen mit den wichtigsten Produktinformationen als Icons und zweisprachigen Stichpunkten gewährleistet, dass der Kunde sich schnell zurechtfindet und sich selbst bedienen kann. Die einheitliche Optik ermöglicht eine aufmerksamkeitsstarke, geschlossene Präsentation des M-Wave Sortiments in jedem Fachgeschäft.

Bright and brilliant blue. With this the uniformly designed M-Wave packaging attracts the attention of the customers.

The optimized design of the packaging with the most important product information as icons and bilingual bullet points ensures that the customer can quickly find his way and serve himself. The uniform look allows an eye-catching, closed presentation of the M-Wave assortment in every specialist shop.



M-WAVE SHOP SYSTEM

ALLES AUF EINEN BLICK - ALLES AUS EINER HAND

Laden Sie den Kunden zum Kaufen ein! Ein professionelles Shop-Design vermittelt Kompetenz, unterstützt Sie in der Beratung, begeistert Ihre Kunden und generiert profitablen Zusatzumsatz für Sie.

YOUR ONE-STOP - SHOP SOLUTION

Invite the customer to buy!

A professional shop design conveys competence, supports you in consulting, inspires your customers and generates profitable additional sales for you.

PREMIUM SLATWALL

Die Premium-Slatwall von M-Wave ermöglicht es Ihnen, die Produkte klar und übersichtlich zu präsentieren. Der Einsatz von PoS-Themenwelten führt Kunden gezielt zum Kontakt und Kennenlernen Ihrer Waren. Gerne unterstützen wir Sie mit thematischen und individuellen Bestückungsvorschlägen.

The premium Slatwall by M-Wave allows you to present the products clearly. The use of PoS theme worlds leads customers to a first contact and to get to know your goods. We are happy to assist you with thematic and individual assembly suggestions.



OUR WEBSHOP

Alle M-Wave Produkte sind in unserem Webshop www.messingschlager.com übersichtlich mit allen wichtigen Eigenschaften und Verkaufsargumenten dargestellt. Sie können dort einfach und schnell bestellt werden!

All M-Wave products are presented in our webshop www.messingschlager.com clearly arranged with all important features and sales arguments. Just order your products here easily and quickly!

www.messingschlager.com



ART.-NR. BESCHREIBUNG
UVP

DESCRIPTION

WARNWESTE ›VEST ILLU‹

- entspricht der europäischen Norm **EN 17353** für Warnbekleidung – bereits Pflicht in vielen europäischen Ländern wie Deutschland, Italien, ...
- 100 % Polyester
- mit **2 Reflexstreifen**
- **Weite sehr flexibel einstellbar** durch elastischen Gummibund

REFLECTIVE VEST ›VEST ILLU‹

- conforms to European **EN 17353** for reflective clothing - already required in many European countries like Germany, Italy, ...
- 100 % polyester
- with **2 reflective tapes**
- **very flexible width adjustment** by using an elastic rubber band



Art. 120934



Art. 120935-7

120934 Kindergröße XXS-XS

child size XXS-XS

120935 Größe S - M

size S - M

120936 Größe M - L

size M - L

120937 Größe XL - XXL

size XL - XXL

5,90 €

DREIECKSWESTE ›SASH ILLU‹

- **super leicht**, atmungsaktiv und mit **maximaler Bewegungsfreiheit**
- neongelbe Weste mit **Reflexstreifen** vorne, hinten und seitlich
- Universalgröße
- **Weite sehr flexibel einstellbar** durch elastischen Gummibund und **verstellbaren** Klettverschlüssen
- für alle Outdoor-Aktivitäten, z. B. Radfahren, Joggen, Walking, ...
- im Polybeutel mit Euroloch

TRIANGLE VEST ›SASH ILLU‹

- **super light**, breathable and offers **maximum mobility**
- neon yellow vest with **reflective tapes** at the front, rear and sides
- unisize
- **very flexible width adjustment** by using an elastic rubber band and **adjustable** hook and loop fasteners
- for all outdoor activities, e. g. cycling, jogging, walking, ...
- in PE bag with eurohole



120939 Größe XS /S

size XS /S

120940 Größe M / L

size M / L

120941 Größe XL / XXL

size XL / XXL

5,90 €

120908 LED-LEUCHTBAND ›WRAP FLASH‹

5,90 €

- für Arme, Beine, ...
- **3M Scotchlite**: **reflektierendes**, neongelbes Band
- 4 rote LEDs
- 2 Funktionen: Dauer- und Blinklicht
- bis zu 300 m und **360°** sichtbar
- für alle Outdoor-Aktivitäten, z. B. Joggen, Walking, ...
- inkl. Batterie (1x CR 2032, Art. 640816)
- in M-Wave Blisterverpackung

LED LIGHT STRAP ›WRAP FLASH‹

- for arms, legs, ...
- **3M Scotchlite**: **reflective**, neon yellow band
- 4 red LEDs
- 2 functions: steady and flashing light
- visibility up to 300 m and **360°**
- for all outdoor activities, e. g. jogging, walking, ...
- incl. battery (1x CR 2032, art. 640816)
- in M-Wave blister packaging



360°

120903 HOSEN-/ARMBAND ›GEAR STRAP ILLU‹

3,90 € / pair

- mit **Reflexstreifen**
- **Weite flexibel einstellbar** durch Gummieinlagen
- mit Klettverschluss
- paarweise im Polybeutel mit M-Wave Eurolochheader

TROUSERS/ARM STRAP ›GEAR STRAP ILLU‹

- with **reflective stripe**
- **flexible width adjustment** through rubber inserts
- with hook and loop fastener
- one pair in PE bag with M-Wave eurohole header



ART.-NR. UVP	BESCHREIBUNG	DESCRIPTION	
120902 3,90 € / pair	HOSEN-/ARMBAND ›SNAP-WRAP‹ Einfach in geradem Zustand auf Arm oder Bein schlagen – fertig! • selbstrollend • neongelb • 30 x 340 mm • paarweise auf M-Wave Eurolochkarte	TROUSERS/ARM STRAP ›SNAP-WRAP‹ Just hit it on the arm or leg when it is uncurled - ready! • self coiling • neon yellow • 30 x 340 mm • one pair on M-Wave eurohole card	
120964 3,50 € / pair	HOSENKLAMMERN ›ILLU PANTCLAMPS N‹ • Stahl • verchromt • mit Reflexstreifen paarweise im Polybeutel paarweise auf M-Wave Eurolochkarte	TROUSERS CLAMPS ›ILLU PANTCLAMPS N‹ • steel • c. p. • with reflective stripe one pair in PE bag one pair on M-Wave eurohole card	
120993 4,90 € / pair	MAGNETKLAMMER ›ILLU LED‹ • 4 weiße LEDs • 2 Funktionen: Dauer- und Blinklicht • mit reflektierendem Material • schnelle, einfache, universelle und schonende Anbringung durch Magnetverschluss • für alle Outdoor-Aktivitäten, z. B. Joggen, Walking, ... • inkl. Batterie CR 2032 (Art. 640814) • auf M-Wave Eurolochkarte	MAGNET CLIP ›ILLU LED‹ • 4 white LEDs • 2 functions: steady and flashing light • reflective material • quick, easy, universal and gentle mounting through magnetic catch • for all outdoor activities e. g. jogging, walking, ... • incl. battery CR 2032 (art. 640814) • on M-Wave eurohole card	
120994 2,90 € / pair	MAGNET ILLU ›MAGNET ILLU‹ • aus reflektierendem Material • schnelle, einfache, universelle und schonende Anbringung durch Magnetverschluss • auf M-Wave Eurolochkarte	MAGNET ILLU ›MAGNET ILLU‹ • reflective material • quick, easy, universal and gentle mounting through magnetic catch • on M-Wave eurohole card	
120990 5,90 € / pair	REFLEXAUFKLEBER ›REFLICKERS SMILE‹ • 3M Scotchlite - Qualität • 4 gelbe Sticker mit schwarzem Aufdruck: 2 x Smile, 2 x 3M-Logo • auf M-Wave Eurolochkarte	REFLECTIVE STICKERS ›REFLICKERS SMILE‹ • 3M Scotchlite quality • 4 yellow stickers with black imprint: 2 x smile, 2 x 3M logo • on M-Wave eurohole card	
120901 4,90 €	REFLEKTOR FÜR SATTELGESTELL ›REFLICKER SWING‹ • schnelle, einfache Anbringung • aus reflektierendem Material „ 3M Diamond “ • erhöht Aufmerksamkeit durch schwingende Befestigung oder Fixierung mit Kabelbinder • zweifarbig: rot und gelb • Größe ca. 89 x 60 mm • mit M-Wave Eurolochheader	REFLECTOR FOR SADDLE RAIL ›REFLICKER SWING‹ • quick, easy mounting • reflective material “ 3M Diamond “ • increases attention by swinging mounting or fixation with cable ties • 2 colorway: red and yellow • size approx. 89 x 60 mm • with M-Wave eurohole header	

ART.-NR. BESCHREIBUNG
UVP

DESCRIPTION

- 120992 REFLEXAUFKLEBER**
›REFLICKERS BOW‹
- 4,90 € / set
- **3M** Scotchlite® - **Qualität**
 - **leicht gebogene Form**
 - **1 Set = 16 Stück (8 x weiß, 8 x gelb)**
 - ca. 0,7 x 10 cm
 - auf M-Wave Eurolochkarte

- REFLECTIVE STICKERS**
›REFLICKERS BOW‹
- **3M** Scotchlite® **quality**
 - **slightly curved shape**
 - **1 set = 16 pieces (8 x white, 8 x yellow)**
 - approx. 0.7 x 10 cm
 - on M-Wave eurohole card

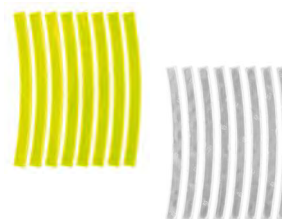

Anbringung auf Felgen im Geltungsbereich der StVZO (Deutschland) unzulässig, da ohne deutsches Prüfzeichen.

- 120970 ABSTANDSFAHNE**
›SF LONG‹
- 14,90 €
- **klappbar**
 - mit einer roten **LED**
 - mit **Bewegungssensor**
 - zur Montage am Gepäckträger oder an der Sitzrohrstrebe (Ø 8 - 20 mm!)
 - Dreiecksflagge mit **Reflexstreifen**
 - Länge Ausleger: 360 mm
 - Größe Fahne: 200 x 120 mm
 - im Polybeutel mit M-Wave Euroloch-header

- REFLECTIVE FLAGPOLE**
›SF LONG‹
- **foldable**
 - with one red **LED**
 - with **movement sensor**
 - to be mounted on the rear carrier or on the seat stay (Ø 8 - 20 mm!)
 - triangle flag with **reflective tapes**
 - length extension arm: 360 mm
 - flag size: 200 x 120 mm
 - in PE bag with M-Wave eurohole header

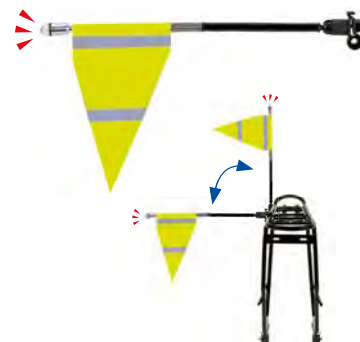

Ohne deutsches Prüfzeichen - Verkauf und Nutzung im Geltungsbereich der StVZO (Deutschland) unzulässig (Abgabe nur an außerdeutsche Kunden).

- 120971 ABSTANDSFAHNE**
›SF SHORT‹
- 5,90 €
- mit Sicherheitsende
 - Länge Ausleger: 380 mm
 - zur Montage am Gepäckträger
 - im Polybeutel mit M-Wave Euroloch-header

- REFLECTIVE FLAGPOLE**
›SF SHORT‹
- with safety end
 - length extension arm: 380 mm
 - to be mounted on the rear carrier
 - in PE bag with M-Wave eurohole header



- 120975 WIMPELSTANGE**
- 3,90 €
- zur Montage an der Hinterradachse
 - ideal für Kinder- und Lauflernfahrräder
 - 150 cm
 - in der Mitte **teilbar**
 - im Polybeutel

- REFLECTIVE FLAG**
- for mounting on the rear hub axle
 - ideal for children and running bikes
 - 150 cm
 - **divisible** in the middle
 - in PE bag

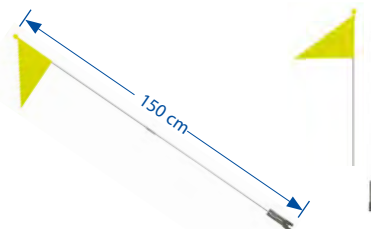

-  **FAHRRADHANDSCHUHE ›GLOW‹**
- **360° reflektierende** Applikationen
 - mit **non-slip-Noppen**
 - Daumen und Zeigefinger mit spezieller Einlage zur **Touchscreenbedienung**
 - mit **Ausziehhilfe**
 - außen teilweise aus **elastischem Lycra**
 - waschbar
 - atmungsaktiv
 - elastischer Bund
 - auf M-Wave Eurolochkarte

- BICYCLE GLOVES ›GLOW‹**
- **360° reflective** applications
 - with **non-slip knobs**
 - thumb and forefinger with contact area for **touchscreen operation**
 - with loops as **take-off assistance**
 - outside partly made of **elastic lycra**
 - washable
 - breathable
 - elastic waistband
 - on M-Wave eurohole card



- 719890** Größe S
- 719891** Größe M
- 719892** Größe L
- 719893** Größe XL

- size S
- size M
- size L
- size XL

13,90 € / set

-  **715206 HALS-/KOPFTUCH**
›NEON YELLOW‹
- 3,90 €
- 57 g
- 100 % Polyester **Funktions-Microfaser**
 - **nahtlos, elastisch** und **atmungsaktiv**
 - Größe: ca. 24 x 48 cm
 - auf M-Wave Eurolochkarte

- TUBULAR HEADWEAR**
›NEON YELLOW‹
- 100 % Polyester **function microfibre**
 - **seamless, elastic** and **breathable**
 - size: approx. 24 x 48 cm
 - on M-Wave eurohole card



ART.-NR. UVP **BESCHREIBUNG**

DESCRIPTION

KINDERHELM ›SMILE‹

- **Microshell** Oberschale
- große **Durchlüftungsöffnungen** mit **Mückenschutz**
- gelb
- integriertes **Visier**
- kinderleichtes Verschlusssystem
- an Kopfgröße anpassbar durch universelles, austauschbares **Ring-Kopfgrößeneinstellsystem**
- im M-Wave Einzelkarton

CHILDREN HELMET ›SMILE‹

- **Microshell** face plate
- big **holes for air circulation** with **fly net**
- yellow
- integrated **visor**
- very simple closing
- adjustable to head size by universal, interchangeable **ring head size adjustment system**
- in M-Wave box

according to EN 1078



730231 Größe **XS, 46 - 52 cm** Kopfumfang
21,90 €

size **XS, 46 - 52 cm** head size

730230 Größe **S, 52 - 57 cm** Kopfumfang
19,90 €

size **S, 52 - 57 cm** head size



HELMÜBERZUG

- **Regenschutz**
- **wasserabweisend**
- atmungsaktiv
- neongelb mit **Reflex-Logo**
- auf M-Wave Eurolochkarte

HELMET COVER

- **rain shelter**
- **water resistant**
- breathable
- neon yellow with **reflective** logo
- on M-Wave eurohole card



120997 ›Kids‹
Kindergröße XS - S

›Kids‹
children size XS - S

120998 ›Peter‹
Größe M - L
5,90 €

›Peter‹
size M - L

120995 HELMÜBERZUG ›MAASTRICHT‹

7,90 €

- **komplett reflektierend für maximale Sichtbarkeit**
- **Regenschutz**
- wasserabweisend
- durch Zugkordel für alle Größen anpassbar
- auf M-Wave Eurolochkarte

HELMET COVER ›MAASTRICHT‹

- **full reflex material for highest visibility**
- **rain shelter**
- waterproof
- adjustable by drawstring for all sizes
- on M-Wave eurohole card



122352 KORB + TASCHENÜBERZUG ›MAASTRICHT PROTECT‹

10,90 €

- **universeller** Regenschutz für **Körbe**, Rucksäcke bis ca. 25 Liter, Vorderradtaschen, Gepäcktaschen, ...
- mit **2 Haltegurten** auf der Rückseite
- neongelb
- **3M Scotchlite® Reflexstreifen** auf drei Seiten
- mit aufgesetzter Netztasche
- auf M-Wave Eurolochkarte

BASKET + BAG COVER ›MAASTRICHT PROTECT‹

- **universal** rain protection for **baskets**, back bags up to approx. 25 litres, front bags, rear bags, ...
- with **2 fixation straps** on back
- neongelb
- **3M Scotchlite® reflective stripes** on three sides
- with fitted net pocket
- on M-Wave eurohole card



ART.-NR. BESCHREIBUNG
UVP

DESCRIPTION

137940 SATTELDECKE ›URBAN‹

6,90 €



- **20 mm Schaumstoffeinlage**
- schwarz mit **reflektierenden Seiten**
- durch Zugkordel für alle Größen anpassbar
- auf M-Wave Eurolochkarte

SADDLE COVER ›URBAN‹

- **20 mm foam pad**
- black with **reflective sideparts**
- adjustable by drawstring for all sizes
- on M-Wave eurohole card



SPEICHENREFLEKTOR

- **3M Scotchlite** Reflexmaterial
- **360° Sichtbarkeit**
- Länge: 70 mm
- einfache, werkzeuglose Montage
- mit **deutschem Prüfzeichen** (gültig bei Anbringung an 36 Speichen in einem Laufrad)

SPOKE REFLECTOR

- **3M Scotchlite** reflective material
- **360° visibility**
- length: 70 mm
- easy, toolless mounting
- with **German approval number** (applies only when mounted on 36 spokes in one wheel)



466670

1 Set = 18 Stück
in M-Wave Blisterverpackung

9,90 € / set

1 set = 18 pcs
in M-Wave blister packaging

466671

Montageverpackung

0,59 €

OEM



M-WAVE BIKEPACKING-SERIE

- besonders reißfestes Ripstop-Gewebe
- 100 % wasserdicht
- jede Menge Stauraum
- extrem belastbar
- viele clevere Features

M-WAVE BIKEPACKING-SERIES

- high tear-resistant ripstop fabric
- 100 % waterproof
- lots of storage space
- extremely resilient
- many clever features

ART.-NR. BESCHREIBUNG
UVP

DESCRIPTION



SATTELTASCHE
›ROUGH RIDE SADDLE‹

- zum Transport von **Gepäck ohne Gepäckträger**
- **100 % wasserdicht**
- **Rollverschluss** für universelle Größeneinstellung
- hohe Reißfestigkeit durch verstärktes Ripstop-Gewebe
- sichere Befestigung mit zwei breiten Klettverschlüssen
- aufgesetzte Gepäckgurte und Schlaufen zur zusätzlichen Gepäckbefestigung, zur Anbringung von Beleuchtung, Schutzblech, Luftpumpe, ...



- **Größe L**
- Volumen bis ca. 11 Liter
- ca. 53 x 13 x 15 cm

122630 schwarz/blau

122636 neongelb, besonders gute **Sichtbarkeit** durch **leuchtende Farbe** und **Reflexaufdruck**
36,90 €

SADDLE BAG
›ROUGH RIDE SADDLE‹

- to transport **luggage without carrier**
- **100 % waterproof**
- **roll cover** for individual size adjustment
- high tensile strength through reinforced ripstop textile
- secure mounting with two wide hook and loop fasteners
- attached luggage belts and loops for the additional luggage connection, for attachment of lights, mudguard, pump, ...

- **size L**
- volume approx. 11 litres
- approx. 53 x 13 x 15 cm

black/blue

neon yellow, very good **visibility** due to **bright colour** and **reflective print**



122625 • **Größe M**
• Volumen bis ca. 6 Liter
• ca. 46 x 9 x 11 cm
• schwarz/blau
29,90 €



- **size M**
- volume approx. 6 litres
- approx. 46 x 9 x 11 cm
- black/blue



LENKERTASCHE
›ROUGH RIDE FRONT‹

- einzeln verwendbarer, **100 % wasserdichter Packsack mit Rollverschluss**
- hohe Reißfestigkeit durch verstärktes Ripstop-Gewebe
- **abnehmbares, transparentes Kartenfach** (Art. 122639)
- sichere Befestigung mit drei universell versetzbaren Klettverschlüssen
- Volumen bis ca. 10 Liter
- ca. 59 x 23 cm

122631 schwarz / blau

122637 neongelb, besonders gute **Sichtbarkeit** durch **leuchtende Farbe** und **Reflexaufdruck**
29,90 €

HANDLEBAR BAG
›ROUGH RIDE FRONT‹

- solo useable, **100 % waterproof duffel with roll cover**
- high tensile strength through reinforced ripstop textile
- **removable, transparent card container** (art. 122639)
- secure mounting with three universally displaceable hook and loop fasteners
- volume approx. 10 litres
- approx. 59 x 23 cm

black / blue

neon yellow, very good **visibility** due to **bright colour** and **reflective print**



ART.-NR. BESCHREIBUNG
UVP

DESCRIPTION

RAHMEN-DREIECKSTASCHE
›ROUGH RIDE TRIANGLE‹

- **wasserdichter Reißverschluss und 100 % wasserdichte Innenauskleidung**
- **Volumen vergrößerbar** auf bis zu 4,2 Liter
- variable Unterteilungsmöglichkeit des Hauptfachs
- hohe Reißfestigkeit durch verstärktes Ripstop-Gewebe
- sichere Befestigung mit fünf universell versetzbaren Klettverschlüssen (Art. 122627)
- vier aufgesetzte Netztaschen für schnellen Zugriff auf wichtige Kleinutensilien
- ca. 42 x 14 - 25 cm

FRAME TRIANGLE BAG
›ROUGH RIDE TRIANGLE‹

- **waterproof zipper and 100 % waterproof inner lining**
- **volume flexible** up to 4.2 litres
- variable dividing possibilities of the main compartment
- high tensile strength through reinforced ripstop textile
- secure mounting with five universally displaceable hook and loop fasteners (art. 122627)
- four attached net pockets for quick access to important small utensils
- approx. 42 x 14 - 25 cm



122632 schwarz / blau

black / blue

122638 neongelb, besonders gute **Sichtbarkeit** durch **leuchtende Farbe** und **Reflexaufdruck**
44,90 €

neon yellow, very good **visibility** due to **bright colour** and **reflective print**

OBERROHRTASCHE
›ROUGH RIDE TOP‹

- **wasserdichter Reißverschluss und wasserdichte Innenauskleidung**
- erschütterungsabsorbierende, weiche Polstereinlage
- verstärkter Boden
- ca. 7 x 8,5 x 29 cm

TOP TUBE BAG
›ROUGH RIDE TOP‹

- **waterproof zipper and waterproof inner lining**
- shock absorbing, soft padding
- reinforced bottom
- approx. 7 x 8.5 x 29 cm



sichere Befestigung mit drei universellen **Klettverschlüssen**

secure mounting with three universal **hook and loop fasteners**

122633 schwarz

black

122640 neongelb, besonders gute **Sichtbarkeit** durch **leuchtende Farbe** und **Reflexaufdruck**

neon yellow, very good **visibility** due to **bright colour** and **reflective print**

122641 schwarz, **2 Ösen zur Direktmontage** am Rahmen
21,90 €

black, **2 eyelets for direct mounting** on the frame

ART.-NR. UVP
BESCHREIBUNG

DESCRIPTION

BIKER SPEZIAL-RUCKSACK
›ROUGH RIDE BACK‹

- **gepolsterte, atmungsaktive Schultertragegurte und Beckengurt**
- zusätzlicher, verstellbarer Brustgurt
- Tragegestell und anpassbares Rückennetzteil für **optimal belüfteten Tragekomfort**
- **integrierter Regenüberzug**
- **inkl. abnehmbarem Helmaufbewahrungsnetz**
- 1 Hauptfach und 4 kleinere Fächer mit Reißverschluss
- integriertes **isoliertes** Fach für **Trinkblase**
- zusätzlich 2 äußere Fächer und 1 großes Innenfach
- mit Rücklichthalter
- Volumen ca. 15 Liter
- ca. 46 x 28 x 12 cm

BIKER SPECIAL BACKPACK
›ROUGH RIDE BACK‹

- **padded, breathable shoulder straps and waist belt**
- additional, adjustable chest belt
- carrying structure and adaptable back net for **optimally ventilated wearing comfort**
- **integrated rain cover**
- **incl. detachable helmet storage net**
- 1 main compartment and 4 smaller pockets with zipper
- integrated **insulated** compartment for **water bag**
- additionally 2 outer compartments and 1 big inner compartment
- with rear light strap
- volume approx. 15 litres
- approx. 46 x 28 x 12 cm



122634 schwarz / blau

black / blue

122635 neongelb, besonders gute **Sichtbarkeit** durch **leuchtende Farbe** und **Reflexaufdruck**
45,90 €

neon yellow, very good **visibility** due to **bright colour** and **reflective print**



BIKER RUCKSACK
›ROUGH RIDE BACK‹ INKL. WASSERBLASE ›SOURCE‹

- Hochwertige Wasserblase ›SOURCE‹** (Art. 122515)
- 2-Liter-Wasserblase mit **antibakterieller Innenbeschichtung**
 - 2.000 % **glattere Oberfläche** als herkömmliche TPU-Folien beugt Schimmelbildung vor
 - **große Öffnung** für schnelles und leichtes Befüllen und Reinigen
 - **geschmacksneutral** und **frei von BPA und Phthalaten**
 - Trinkschlauch mit **antibakterieller Innenbeschichtung** und **auswechselbarem Silikon-Mundstück** (Art. 122516)

BIKER BACKPACK
›ROUGH RIDE BACK‹ INCL. WATER BAG ›SOURCE‹

- high-quality water bag ›SOURCE‹** (art. 122515)
- 2-litres-water bag with **antimicrobial protection inside**
 - 2,000 % **smoother surface** than conventional TPU foils prevents mould formation
 - **big opening** for fast and easy filling and cleaning
 - **tasteless and free from BPA and phthalates**
 - drinking tube with **antimicrobial protection inside** and **exchangeable silicone bite valve** (art. 122516)



SOURCE

122620 schwarz / blau

black / blue

122621 neongelb, besonders gute **Sichtbarkeit** durch **leuchtende Farbe** und **Reflexaufdruck**
59,90 €

neon yellow, very good **visibility** due to **bright colour** and **reflective print**

122538 **E-BIKE AKKUTASCHE**
›ROUGH RIDE B‹

37,90 €



- universeller, gepolsterter **Transportschutz** für Unterrohr- und Gepäckträgerakkus (passend für fast alle Akku-Typen)
- **100 % wasserdicht**
- Rollverschluss ermöglicht **variable Größeneinstellung**
- hohe Reißfestigkeit durch verstärktes Ripstop-Gewebe
- **universelle** und **sichere** Befestigung durch breite Klettverschlüsse am **Rahmenrohr, Gepäckträger, ...**
- mit non-slip Einlagen und **Reflexlogo**
- Größe: ca. 55 x 8,5 x 13 cm (L x B x H)
- Volumen ca. 7 L

E-BIKE BATTERY BAG
›ROUGH RIDE B‹

- universal, padded **transport protection** for down tube and carrier batteries (suitable for almost all battery types)
- **100 % waterproof**
- **expandable** via roll cover
- high tear resistance through reinforced ripstop textile
- **universal and secure** mounting to the **frame tube, carrier, ...** with wide hook and loop fasteners
- with non-slip inlays and **reflex logo**
- size: approx. 55 x 8.5 x 13 cm (L x W x H)
- volume approx. 7 litres



ART.-NR. BESCHREIBUNG
UVP

DESCRIPTION

122881 GEPÄCKTRÄGERTASCHE
›SUBURBAN CARRY‹

51,90 €

- **100 % wasserdicht** und staubdicht
- mit **verschweißten Nähten**
- mit biologisch abbaubarer und sehr langlebiger **TPU-Beschichtung**
- sehr stabil und strapazierfähig trotz geringem Gewicht
- **Rollverschluss** für universelle Größeneinstellung
- mit entnehmbarem **Innentasche**
- integrierte Seitentasche mit **verschweißtem Reißverschluss**
- mit flexiblem Gummiband-Helmhalter
- stabiler, verstellbarer **Clip-on**-Halter zur sekundenschnellen (De-)Montage über **Griffzug** an Gepäckträgerrohren von 9 - 16 mm (Ersatzhaken Art. 122889)
- zusätzliche **3. Fixierungsmöglichkeit** an der Gepäckträgerstrebe
- mit **Reflexaufdruck**
- Größe ca. 33 x 14,5 x 61 cm (L x B x H)
- Volumen ca. 25 Liter

CARRIER SINGLE BAG
›SUBURBAN CARRY‹

- **100 % waterproof** and dustproof
- with **heat-sealed joints**
- with biodegradable and very durable **TPU coating**
- very stable and hard-wearing despite low weight
- **roll cover** for individual size adjustment
- with detachable **inner bag**
- integrated side pocket with **heat-sealed zipper**
- with flexible rubber strap helmet holder
- firm, adjustable **clip-on** bracket for (de-)mounting within seconds by **pulling the handle** on carrier tubes of 9 - 16 mm (replacement hook art. 122889)
- additional **3rd mounting option** at the luggage stay
- with **reflective print**
- size approx. 33 x 14.5 x 61 cm (L x W x H)
- volume approx. 25 litres

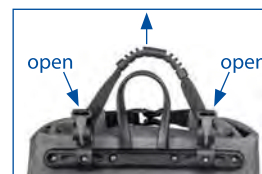

122882 LENKERTASCHE
›SUBURBAN FRONT‹

38,90 €

 22,2 - 31,8 mm

- **100 % wasserdicht** und staubdicht
- mit **verschweißten Nähten**
- mit biologisch abbaubarer und sehr langlebiger **TPU-Beschichtung**
- sehr stabil und strapazierfähig trotz geringem Gewicht
- **Rollverschluss** für universelle Größeneinstellung
- **wasserdichtes, transparentes Sichtfenster** zur Bedienung eines **Touch-displays**
- integrierte Seitentaschen mit **verschweißtem Reißverschluss**
- stabiler 2-Punkt **Clip-on**-Halter mit einfacher (De-)Montage, passend für Lenker-Ø **22,2 - 31,8 mm** (Art. 122709)
- absolut **verdrehsicher**
- innen mit zusätzlicher Versteifung
- mit Schultergurt
- mit **Reflexaufdruck**
- Größe ca. 13 x 28 x 21 cm (L x B x H)
- Volumen ca. 7 Liter

HANDLEBAR BAG
›SUBURBAN FRONT‹

- **100 % waterproof** and dustproof
- with **heat-sealed joints**
- with biodegradable and very durable **TPU coating**
- very stable and hard-wearing despite low weight
- **roll cover** for individual size adjustment
- **waterproof, transparent window** for operating a **touch display**
- integrated side pockets with **heat-sealed zipper**
- stable 2-point **clip-on** bracket with easy (de-)mounting, suitable for handlebar Ø **22.2 - 31.8 mm** (art. 122709)
- absolutely **anti-twist**
- additional internal stiffness
- with shoulder strap
- with **reflective print**
- size approx. 13 x 28 x 21 cm (L x W x H)
- volume approx. 7 litres



122883 OBERROHRTASCHE
›SUBURBAN TOP‹

14,90 €

 XL

- **100 % wasserdicht** und staubdicht
- mit **verschweißten Nähten und Reißverschluss**
- mit biologisch abbaubarer und sehr langlebiger **TPU-Beschichtung**
- sehr stabil und strapazierfähig trotz geringem Gewicht
- **wasserdichtes, transparentes Sichtfenster** zur Bedienung eines **Touch-displays**
- für große Smartphones, wie iPhone X
- sichere Befestigung mit 3 Klettverschlüssen
- verstärkter Boden
- mit **Reflexaufdruck**
- Größe ca. **18,5 x 9,5 x 8,5 cm** (L x B x H)

TOP TUBE BAG
›SUBURBAN TOP‹

- **100 % waterproof** and dustproof
- with **heat-sealed joints and zipper**
- with biodegradable and very durable **TPU coating**
- very stable and hard-wearing despite low weight
- **waterproof, transparent window** for operating a **touch display**
- for big smartphones like iPhone X
- secure mounting with 3 hook and loop fasteners
- reinforced bottom
- with **reflective print**
- size approx. **18.5 x 9.5 x 8.5 cm** (L x W x H)





ART.-NR. BESCHREIBUNG
UVP

DESCRIPTION

122884 SATTELTASCHE
›SUBURBAN SADDLE‹
17,90 €

- **100 % wasserdicht** und staubdicht
- mit **verschweißten Nähten**
- mit biologisch abbaubarer und sehr langlebiger **TPU-Beschichtung**
- sehr stabil und strapazierfähig trotz geringem Gewicht
- sichere Befestigung mit 3 Klettverschlüssen
- **Rollverschluss** für universelle Größeneinstellung
- mit **Reflexaufdruck**
- Größe ca. 20 x 9 x 9 cm (L x B x H)
- Volumen max. 2,5 Liter

SADDLE BAG
›SUBURBAN SADDLE‹

- **100 % waterproof** and dustproof
- with **heat-sealed joints**
- with biodegradable and very durable **TPU coating**
- very stable and hard-wearing despite low weight
- secure mounting with 3 hook and loop fasteners
- **roll cover** for individual size adjustment
- with **reflective print**
- size approx. 20 x 9 x 9 cm (L x W x H)
- volume max. 2.5 litres



122888 SCOOTER-/LENKERTASCHE
›SUBURBAN MESSENGER COMPACT‹
19,90 €

- **100 % wasserdicht** und staubdicht
- mit **verschweißten Nähten**
- mit biologisch abbaubarer und sehr langlebiger **TPU-Beschichtung**
- zusätzliche Außentasche
- sehr stabil und strapazierfähig trotz geringem Gewicht
- mit gepolstertem, verstellbarem Schultergurt
- mit **Einschubtasche** am Schultergurt für Smartphones, ...
- sichere Befestigung durch vier Klettverschlüsse an Fahrrädern, Rollern, ...
- mit **Reflexaufdruck**
- Größe ca. 23 x 10,5 x 33 cm (L x B x H)
- Volumen max. 8 Liter

SCOOTER/HANDLEBAR BAG
›SUBURBAN MESSENGER COMPACT‹

- **100 % waterproof** and dustproof
- with **heat-sealed joints**
- with biodegradable and very durable **TPU coating**
- additional outer pocket
- very stable and hard-wearing despite low weight
- with padded, adjustable shoulder strap
- with **slide-in pocket** at the shoulder strap for smartphones, ...
- secure mounting with four hook and loop fasteners to bicycles, scooters, ...
- with **reflective print**
- size approx. 23 x 10.5 x 33 cm (L x W x H)
- volume max. 8 litres



CANADA PRO



CANADA PRO



CANADA PRO



GEPÄCKTRÄGERTASCHE

- **100 % wasserdicht** durch **verschweißte Nähte**
- extrem **strapazierfähiges** Material
- stabiler **Rixen & Kaul Clip-on**-Halter zur sekundenschnellen (De-)Montage an **Gepäckträgerrohren von 5 - 12 mm!** (Ersatzhaken = Art. 122702)
- zusätzliche **3. Fixierungsmöglichkeit** an der Gepäckträgerstrebe (Ersatzhaken = Art. 122712)
- Rollverschluss
- **zusätzlicher** Schutz durch **Deckelverschlussklappe**
- mit **Tragegriffen** und Befestigungsringen für Schultergurt (Art. 122700)
- Clip-Befestigungsmöglichkeiten für Packsack Art. 122730
- **Verstärkungen** an der Unterseite
- **Rücken- und Kantenschutz**
- mit **Reflexstreifen**
- paarweise im Polybeutel

BICYCLE CARRIER BAG

- **100 % waterproof** through **heat-sealed joints**
- extremely **tough** material
- stable **Rixen & Kaul clip-on** bracket for (de-)mounting within seconds on **tubes of carrier from 5 - 12 mm!** (replacement hook = art. 122702)
- additional **3. mounting option** on the side bars of the carrier (replacement hook = art. 122712)
- roll cover
- **additional** protection by **top cover**
- with **handle** and fixation rings for shoulder strap (art. 122700)
- clip fixing possibility for duffel bag art. 122730
- **reinforcements** at the bottom
- with **rear and edge protection**
- with **reflective stripes**
- one pair in PE bag



›ALBERTA‹
Volumen ca. **2 x 20 Liter**

›ALBERTA‹
volume approx. **2 x 20 litres**

122720 schwarz

black

122728 rot

red

124,00 € / pair

122724 ›MANITOBA‹
Volumen ca. **2 x 12,5 Liter**

›MANITOBA‹
volume approx. **2 x 12.5 litres**

99,90 € / pair

ART.-NR. BESCHREIBUNG
UVP

DESCRIPTION

CANADA



CANADA



CANADA



Bags



GEPÄCKTRÄGERTASCHE

- **100 % wasserdicht** durch **verschweißte Nähte**
- extrem **strapazierfähiges** Material
- hervorragendes Preis-/Leistungsverhältnis
- stabiler, verstellbarer **Clip-on-Halter** zur sekundenschnellen (De-)Montage an **Gepäckträgerrohren von 5 - 12 mm**
- zusätzliche **3. Fixierungsmöglichkeit** an der Gepäckträgerstrebe
- Rollverschluss
- **zusätzlicher** Schutz durch **Deckelverschlussklappe**
- mit **Tragegriffen** und Befestigungsringen für Schultergurt (Art. 122739)
- **Verstärkungen** an der Unterseite
- **Rücken- und Kantenschutz**
- mit **Reflexstreifen**
- paarweise im Polybeutel

BICYCLE CARRIER BAG

- **100 % waterproof** through **heat-sealed joints**
- extremely **tough** material
- great value
- firm, adjustable **clip-on** 3-point bracket for (de-)mounting within seconds on **carrier tubes from 5 - 12 mm**
- additional **3. mounting option** on the side bars of the carrier
- roll cover
- **additional** protection by **top cover**
- with **handle** and fixation rings for shoulder strap (art. 122739)
- **reinforcements** at the bottom
- with **rear** and **edge protection**
- with **reflective stripes**
- one pair in PE bag



122722 ›MONTREAL‹

- 106,00 € /pair
- Volumen ca. **2 x 20 Liter**
- für hinten

›MONTREAL‹

- volume approx. **2 x 20 litres**
- for rear

122725 ›CALGARY‹

- 89,90 € / pair
- Volumen ca. **2 x 12,5 Liter**
- für vorne und hinten

›CALGARY‹

- volume approx. **2 x 12.5 litres**
- for front and rear

122880 GEPÄCKTRÄGERTASCHE ›EDMONTON‹

29,90 €



- **100 % wasserdicht** durch **verschweißte Nähte**
- **strapazierfähiges** Material
- Volumen ca. 16 Liter
- mit Netzaußentasche
- stabiler, verstellbarer **Clip-on-Halter** zur sekundenschnellen (De-)Montage über **Griffzug** an Gepäckträgerrohren von 9 - 16 mm (Ersatzhaken Art. 122889)
- zusätzliche **3. Fixierungsmöglichkeit** an der Gepäckträgerstrebe
- mit Schultergurt
- mit **Reflexmaterial** an den Seiten

CARRIER SINGLE BAG ›EDMONTON‹

- **100 % waterproof** through **heat-sealed joints**
- **tough** material
- volume approx. 16 litres
- with outer net pocket
- firm, adjustable **clip-on** bracket for (de-)mounting within seconds by **pulling the handle** on carrier tubes of 9 - 16 mm (replacement hook art. 122889)
- additional **3. mounting option** at the luggage stay
- with shoulder strap
- with **reflex material** on the sides

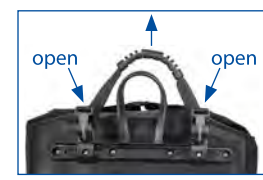

122715 LENKERTASCHE ›OTTAWA‹

49,90 €



- **100 % wasserdicht** durch **verschweißte Nähte**
- extrem **strapazierfähiges** Material
- stabiler 2-Punkt **Clip-on-Halter** (= Art. 122709) mit einfacher (De-)Montage, passend für Lenker-Ø **22,0 - 31,8 mm**
- absolut verdrehsicher auch bei max. Zuladung von 9 kg
- herausnehmbare Innentasche
- innen zusätzliche Versteifung
- 2 zusätzliche Netzaußentaschen
- mit **Reflexlabel**
- wasserdichte, abnehmbare und beidseitig verwendbare, transparente Kartentasche
- mit Schultergurt
- Volumen ca. 7 Liter

HANDLEBAR BAG ›OTTAWA‹

- **100 % waterproof** through **heat-sealed joints**
- extremely **tough** material
- stable 2-point **clip-on** bracket (= art. 122709) with easy (de-)mounting, suitable for handlebar Ø **22.0 - 31.8 mm**
- anti-twist, also at max. load of 9 kg
- removable inner pocket
- additional internal stiffness
- 2 additional outer net pockets
- with **reflex label**
- waterproof, detachable and double-sided transparent map pocket
- with shoulder strap
- volume approx. 7 litres



122737 Ersatz-/Zweit-Halter, passend für E-Bike Mitteldisplays, für Art. 122715, auf M-Wave Eurolochkarte

15,90 €



replacement /second bracket, suitable for **e-bike center display**, for art. 122715, on M-Wave eurohole card



ART.-NR. BESCHREIBUNG
UVP

DESCRIPTION

122406 SMARTPHONE TASCHE
›BLACK BAY‹

24,90 €



- **100 % wasserdicht**
- Handy durch großes, transparentes Sichtfenster **bedienbar**
- ca. 17 x 8 x 1 cm (L x B x H)
- durch Einlagen passend für alle gängigen Smart- und iPhones
- mit **Universalhalter** für Ø 20 bis 60 mm, passend auch für Garmin (kein original Garmin Ersatzteil)
- **breites Fenster** zur Nutzung des Smartphones als **Actionkamera**
- auf M-Wave Eurolochkarte

SMARTPHONE BAG
›BLACK BAY‹

- **100 % waterproof**
- mobile phone **operable** through large transparent window
- approx. 17 x 8 x 1 cm (L x W x H)
- suitable for all common smartphones and iPhones by inserts
- with **universal bracket** for Ø 20 up to 60 mm, also suitable for Garmin (no original Garmin spare part)
- **wide window** to use the smartphone as **action camera**
- on M-Wave eurohole card



Bags

122730 PACKSACK
›HUDSON BAY‹

34,90 €



- **100 % wasserdicht** durch **verschweißte Nähte**
- extrem **strapazierfähiges** Material
- mit **Tragegriffen** und Befestigungsringen für Schultergurt (Art. 122700)
- universell einsetzbar
- mit Bändern oder Gurten auf Seitentaschen fixierbar (auch 2 Stück!)
- mit Rollverschluss und **Sichtfenster**
- mit **Reflexlabel**
- Volumen ca. 28 Liter, ca. 60 cm lang

DUFFLE BAG
›HUDSON BAY‹

- **100 % waterproof** through **heat-sealed joints**
- extremely **tough** material
- with **handles** and fixation rings for shoulder strap (art. 122700)
- universally useable
- can be mounted on the side bags by straps (also 2 duffle bags!)
- with roll cover and **window**
- with **reflex label**
- volume approx. 28 litres, approx. 60 cm long



122739 SCHULTERGURT FÜR
E-SCOOTER / FALTRÄDER

6,90 €

- z. B. für Art. 659905/659885/659886, ...
- Breite: 25 mm
- im Polybeutel mit Einleger

SHOULDER STRAP FOR
E-SCOOTER / FOLDING BIKES

- e. g. for art. 659905/659885/659886, ...
- width: 25 mm
- in PE bag with sheet



122522 UNIVERSALTASCHE
›TRAVELLERS BAG‹

49,90 €



- **100 % wasserdicht** durch **verschweißte Nähte**
- extrem **strapazierfähiges** Material
- mit **Reflexaufdruck**
- ca. 605 x 385 x 550 mm (L x B x H)
- Volumen ca. **120 Liter**
- auch passend für Gepäckanhänger (z. B. Art. 640081)

UNIVERSAL BAG
›TRAVELLERS BAG‹

- **100 % waterproof** through **heat-sealed joints**
- extremely **tough** material
- with **reflective print**
- approx. 605 x 385 x 550 mm (L x W x H)
- volume approx. **120 litres**
- also suitable for luggage trailer (e. g. art. 640081)



ART.-NR. BESCHREIBUNG
UVP

DESCRIPTION

122380 MESSENGER TASCHE

42,90 €

›LOCKERS BAY‹

- **integrierter, justierbarer Gepäck-trägerhalter** (optimiert für linke Seite) mit **Reißverschlussabdeckung**
- große Innentasche mit 2 aufgesetzten Fächern
- gepolstertes **15" Notebook** Rücken-fach mit Klettverschluss
- zwei Außentaschen für Trinkflaschen, ...
- Volumen ca. 25 Liter
- justierbares Gurtband
- **Reflexstreifen** rechts und links

MESSENGER BAG

›LOCKERS BAY‹

- **integrated, adjustable mount for rear carriers** (optimized for left side) with **zipper cover**
- big compartment with 2 attached pockets
- padded **15" notebook** compartment with hook and loop fastener
- two outer pockets for water bottles, ...
- volume approx. 25 litres
- adjustable belt
- **reflective tape** on right and left side

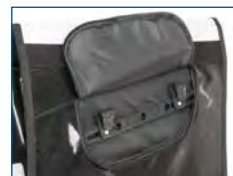

NIEDERLANDE



NETHERLANDS



121920 HARTSCHALEN-LENKERTASCHE

35,90 €

›UTRECHT HC‹

- **stabile, stoßfeste ABS-Kunststoff-Schalen**
- hochwertige, seidenmatte und strukturierte Oberfläche
- **wasserdicht** durch verschweißte Doppel-Reißverschlüsse
- Stoffauskleidung innen
- Maße: 26 x 16 x 19 cm (L x B x H)
- Volumen ca. 8 Liter
- mit Schultergurt
- mit separater Innentasche
- abnehmbare, transparente Kartenttasche
- mit stabilem **Clip-on-Halter** (= Art. 122709) passend für **Ø 22,0 mm bis 31,8 mm**

HARD SHELL-HANDLEBAR BAG

›UTRECHT HC‹

- **firm, shock-resistant ABS plastic shells**
- high quality, silk-matt and textured surface
- **waterproof** due to sealed double zippers
- fabric inner lining
- size: 26 x 16 x 19 cm (L x W x H)
- volume approx. 8 litres
- with shoulder belt
- with separate inner pocket
- detachable transparent map pocket
- with stable **clip-on bracket** (= art. 122709) suitable for **Ø 22.0 mm up to 31.8 mm**



GEPÄCKTRÄGERBOX/TOPCASE
›AMSTERDAM BOX L‹

- **absperribar**, inkl. 2 Schlüssel (Ersatzschloß + Federclip + 2 Schlüssel = Art. 122466)
- aus hochwertigem Kunststoff
- **staub- und wasserfest**
- **Volumen ca. 17 Liter**
- Maße: 42 x 26 x 21 cm (L x B x H)
- zur Montage auf dem Gepäckträger
- mit 2 Seitenverschlüssen (Art. 122467)

CARRIER TOP CASE
›AMSTERDAM BOX L‹

- **lockable**, incl. 2 keys (replacement lock + spring clip + 2 keys = art. 122466)
- high quality plastic
- **dust and water resistant**
- **volume approx. 17 litres**
- size: 42 x 26 x 21 cm (L x W x H)
- for fixing on the rear carrier
- with 2 closing parts (art. 122467)



122460 im Einzelkarton

49,90 €

in box

122470 mit Info-Aufkleber im Polybeutel Spart Verpackungsvolumen!

46,90 €

with info sticker in PE bag Saves packaging volume!

ART.-NR. UVP **BESCHREIBUNG**

DESCRIPTION

GEPÄCKTRÄGERBOX

- Klemmbügel für sicheren Verschluss
- Vorrichtung für **Vorhängeschloss**
- 4 **Spanngurthalter** (Art. 122490)
- aus hochwertigem Kunststoff
- **staub-** und **wasserfest**
- zur Montage auf dem Gepäckträger

CARRIER TOP CASE

- clamp for safe closure
- fixing point for **padlock**
- 4 **tension belt brackets** (art. 122490)
- high quality plastic
- **dust** and **water resistant**
- for mounting on the rear carrier



122463 ›AMSTERDAM EASY BOX XL‹
34,90 €
• Volumen ca. **18 Liter**
• Maße: 42 x 31 x 22 cm (L x B x H)

L-XL

›AMSTERDAM EASY BOX XL‹
• volume approx. **18 litres**
• size: 42 x 31 x 22 cm (L x W x H)

122464 ›AMSTERDAM EASY BOX S‹
24,90 €
• Volumen ca. **5 Liter**
• Maße: 27 x 20 x 15 cm (L x B x H)

S-M

›AMSTERDAM EASY BOX S‹
• volume approx. **5 litres**
• size: 27 x 20 x 15 cm (L x W x H)



122465 Ersatzverschluss
2,90 €

replacement closing part



122491 Ersatzstopfen zur Befestigung des Deckels
0,49 €

replacement plugs to mount the top



122492 Ersatzmontage-Set
1,99 € / set

replacement mounting parts



122479 **LENKERBOX**
›AMSTERDAM BOX FRONT‹
27,90 €

- **abschließbar**, inkl. 2 Schlüssel
- zur Montage am Steuersatz (1") und der Vorderradnabe (Adapter für 1 1/8" Steuersatz erhältlich = Art. 431799)
- aus Kunststoff
- **staub-** und **spritzwassergeschützt**
- passend für 26" - 29" Reifen
- Bügel zum leichten Öffnen und zum Schutz des Schließzylinders
- Volumen ca. 17 Liter
- Maße: 23 x 26 x 33 cm

FRONT TOP CASE
›AMSTERDAM BOX FRONT‹

- **lockable**, incl. 2 keys
- for mounting at the head set (1") and the front wheel hub (adapter for 1 1/8" head set available = art. 431799)
- plastic
- **dust** and **water protected**
- suitable for 26" - 29" tires
- bracket for easy opening and for protection of the lock cylinder
- volume approx. 17 litres
- size: 23 x 26 x 33 cm



ART.-NR. UVP **BESCHREIBUNG**

DESCRIPTION

122310 GEPÄCKTRÄGERTASCHE ›AMSTERDAM TRIPLE‹

69,90 €

ein Modell voller guter Ideen:

- Hauptfächer durch Kunststoffböden **verstärkt**
- Gesamtbreite ca. 65 cm

Seitentaschen:

- Maße: 34 x 17 x 32 cm (L x B x H), Inhalt ca. 34 Liter
- **großes Hauptfach**, durch regengeschützten Reißverschluss von der Seite zugänglich, **kein umständliches Suchen!**
- aufgesetzte **Seitentasche** und **Hecktasche** (als Flaschenhalter verwendbar)
- mit **Reflexstreifen**
- mit **Schnellverschluss** am Gepäckträger zu befestigen und Aussparungen für Gepäckträgerklemme
- mit **Tragegriff** zwischen den Taschen

Toptasche:

- Maße: 34 x 46 x 21 cm, ca. 28 Liter
- mit **Schnellverschluss** an den Seitentaschen befestigt
- bei Bedarf kann eine zweite Toptasche aufgesetzt werden!
- durch langen, regengeschützten Reißverschluss in allen Ecken leicht zugänglich
- mit **aufgesetzter Kleinteiletasche**, **flexiblem Helmhalter** und **Tasche** darunter
- kann als **Rucksack** getragen werden!
- mit **Tragegriff**, **Schultergurt** und **Rücklichthalter**

BICYCLE CARRIER BAG ›AMSTERDAM TRIPLE‹

this model is full of good ideas:

- main compartments **reinforced** by plastic walls
- total width approx. 65 cm

side bags:

- size: 34 x 17 x 32 cm (L x W x H), content approx. 34 litres
- **large main compartment**, accessible from the side by rain protected zipper, **no long-winded searching!**
- attached **side bag** and **rear bag** (usable as bottle cage)
- with **reflective stripes**
- with **QR** for fixing at the carrier and holes for the carrier clamp
- with **handle** between the bags

top bag:

- size: 34 x 46 x 21 cm, approx. 28 litres
- with **QR** fixed to the side bags
- if required a second top bag can be put on top!
- all corners are easily accessible through a long rain protected zipper
- with **attached small parts bag**, **flexible helmet holder** and **pocket** underneath
- can be carried as **backpack!**
- with **handle**, **shoulder strap** and **rear light bracket**



122317 GEPÄCKTRÄGERTASCHE ›AMSTERDAM DOUBLE L‹

41,90 €

- Material: Kunstleder in **Echtledeeroptik**
- Maße: Gesamtbreite ca. 25 cm
Taschen: je 27,5 x 9 x 33,5 cm (L x B x H)
- Volumen ca. 15 Liter
- **große Hauptfächer** mit Metallschnallen und zusätzlichen **Schnellverschlüssen**
- durch Kunststoffböden **verstärkt**
- Tragegriff zwischen den Taschen
- mit **Aussparungen** oben zum **sicheren Befestigen** auf dem Gepäckträger

BICYCLE CARRIER BAG ›AMSTERDAM DOUBLE L‹

- material: imitation leather in **genuine leather appearance**
- size: total width approx. 25 cm
bags: each 27.5 x 9 x 33.5 cm (L x W x H)
- volume approx. 15 litres
- **large main compartments** with metal buckles and additional **quick fasteners**
- **reinforced** by plastic walls
- handle between the bags
- **slots** on the top for **safe mounting** on the rear carrier



122210 OBERROHRTASCHE ›ROTTERDAM TOP XL LE‹

10,90 €

Größe: ca. **18,5 x 9,5 x 8,5 cm** (L x B x H)

Weitere Artikelinformationen auf Seite 38.

TOP TUBE BAG ›ROTTERDAM TOP XL LE‹

size: approx. **18.5 x 9.5 x 8.5 cm** (L x W x H)

More product information on page 38.



ART.-NR. UVP	BESCHREIBUNG	DESCRIPTION	
	<p>GEPÄCKTRÄGERTASCHE ›AMSTERDAM DOUBLE‹</p> <ul style="list-style-type: none"> • Maße: Gesamtbreite ca. 50 cm Taschen: je 34 x 17 x 30 cm (L x B x H) • Volumen ca. 30 Liter • große Hauptfächer mit Schnellverschlüssen • durch Kunststoffböden verstärkt • Reflexstreifen und Netz hinten • Tragegriff zwischen den Taschen • mit Aussparungen oben zum sicheren Befestigen auf dem Gepäckträger 	<p>BICYCLE CARRIER BAG ›AMSTERDAM DOUBLE‹</p> <ul style="list-style-type: none"> • size: total width approx. 50 cm bags: each 34 x 17 x 30 cm (L x W x H) • volume approx. 30 litres • large main compartments with QRs • reinforced by plastic walls • reflective stripes and netting on the back • handle between the bags • slots on the top for safe mounting on the rear carrier 	
122315	schwarz	black	
122802	schwarz/weiß	black/white	
122803	schwarz/rot	black/red	
122804	schwarz/blau	black/blue	
122805	schwarz/grün	black/green	
27,90 €			
	<p>122319 REGENHAUBE ›AMSTERDAM PROTECT‹</p> <p>10,90 €</p> <ul style="list-style-type: none"> • universeller Regenschutz • auch passend für Art. 122310/5, 122802-5, ... • mit M-Wave Banderole 	<p>RAIN COVER ›AMSTERDAM PROTECT‹</p> <ul style="list-style-type: none"> • universal rain protection • also suitable for art. 122310/5, 122802-5, ... • with M-Wave banderole 	
	<p>122304 SEIDENTASCHE UND TROLLEY ›AMSTERDAM TR S‹</p> <p>69,90 €</p> <p>2 IN 1</p> <p>Diese Tasche kann als Gepäckträger-tasche und Trolley verwendet werden!</p> <ul style="list-style-type: none"> • Maße: ca. 38 x 20 x 45 cm • großes Hauptfach mit Netztasche, aufgesetzte Außentasche und Trinkflaschenhalter • Teleskop-Zugstange • mit 3-Punkt Clip-on-Halter für den Gepäckträger (Haken oben = Art. 122889, Haken unten = Art. 122719) • mit Reflektoren • mit 2 Rollen mit Industriekugellager und 2 Abstellfüßen 	<p>CARRIER SINGLE BAG AND TROLLEY ›AMSTERDAM TR S‹</p> <p>This bag is usable as bicycle bag and as a trolley!</p> <ul style="list-style-type: none"> • size: approx. 38 x 20 x 45 cm • large main compartment with net pocket, attached outer pocket and bottle holder • telescope drawbar • with 3-point clip-on bracket for rear carriers (upper hook = art. 122889, lower hook = art. 122719) • with reflectors • with 2 wheels with sealed bearing and 2 stand-on feet 	
	<p>GEPÄCKTRÄGERTASCHE ›AMSTERDAM SINGLE‹</p> <ul style="list-style-type: none"> • Maße: 38 x 18 x 30 cm (L x B x H) • Volumen ca. 18 Liter • große Tasche mit Schnellverschlüssen • Reflexstreifen und Tragegriff • Schnellbefestigung durch 2 Haken und 1 Spanngummi (Art. 122322) 	<p>BICYCLE CARRIER SINGLE BAG ›AMSTERDAM SINGLE‹</p> <ul style="list-style-type: none"> • size: 38 x 18 x 30 cm (L x W x H) • volumen approx. 18 litres • large bag with QRs • with reflective stripes and handle • quick mounting through 2 hooks and 1 elastic band (art. 122322) 	
122320	links	left	
122321	rechts	right	
19,90 €			

ART.-NR. BESCHREIBUNG
UVP

DESCRIPTION

122745 GEPÄCKTRÄGER-TASCHEN-ORGANIZER ›AMSTERDAM INSERT‹

13,90 €

- mit gepolstertem **Laptopfach**
- Hauptfach durch **flexible Trennwände** aufteilbar
- für Art. 122315, 122320/1 ...
- ca. 30 x 14 x 27 cm (L x B x H)
- mit M-Wave Karte

ORGANIZER FOR REAR CARRIER BAG ›AMSTERDAM INSERT‹

- with upholstered **laptop compartment**
- main compartment with **flexible dividers**
- for art. 122315, 122320/1 ...
- approx. 30 x 14 x 27 cm (L x W x H)
- with M-Wave tag



122318 DRYBAG ›AMSTERDAM DRY‹

8,99 €



- **100 % wasserdicht**
- universeller Einsatzbereich
- **Rollverschluss** für universelle Größeneinstellung
- passend auch als herausnehmbare **Innentasche** für **Gepäckträgertasche** (Art. 122320, ...)
- Größe ca. 40 x 42 x 16 cm (L x B x H)
- auf M-Wave Eurolochkarte

DRYBAG ›AMSTERDAM DRY‹

- **100 % waterproof**
- universal uses
- **roll cover** for individual size adjustment
- also suitable as removable **inner bag** for bicycle **carrier bag** (art. 122320, ...)
- size approx. 40 x 42 x 16 cm (L x W x H)
- on M-Wave eurohole card



122312 GEPÄCKTRÄGERTASCHE ›AMSTERDAM EXP‹

29,90 €

- großes Hauptfach mit Innentasche
- **erweiterbar durch zwei große aufklappbare Seitentaschen**
- Volumen ca. 16 Liter
- **Haltenetz** oben
- schnelle und einfache Fixierung durch Klettverschlüsse am Gepäckträger
- mit **Trinkflaschenhalter**
- mit Pumpenhalter
- mit Schulterriemen und Reflektoren

BICYCLE CARRIER BAG ›AMSTERDAM EXP‹

- large main compartment with inner bag
- **expandable through two large side bags**
- volume approx. 16 litres
- **attachment net** on top
- fast and easy velcro attachment to any rear carrier
- with **bottle holder**
- with bracket for pump
- with shoulder straps and reflectors



ART.-NR. BESCHREIBUNG
UVP

DESCRIPTION

122384 LENKERTASCHE
›UTRECHT FOLD‹

34,90 €



- platzsparend **zusammenfaltbar**
- Größe: 37 x 25 x 25 cm (L x B x H)
- Volumen ca. 20 Liter
- mit **Clip-on**-Halter passend für Ø 22,2 bis **31,8 mm**
- stabiler **Rahmen** + feste **Bodenplatte** mit Abstellfüßen
- **2 Tragegurte** zum Zusammenkletten
- **Außentasche** mit Reißverschluss
- mit **Regenschutz**
- mit Reflexlogo
- mit M-Wave Banderole

HANDLEBAR BAG
›UTRECHT FOLD‹

- space savingly **foldable**
- size: 37 x 25 x 25 cm (L x W x H)
- volume approx. 20 litres
- with **clip-on** bracket for Ø 22.2 up to **31.8 mm**
- stable **frame** and robust **floor plate** with stand-on feets
- **2 carrying straps** (can be tied up)
- **outer pocket** with zipper
- with **rain shelter**
- with reflective logo
- with M-Wave banderole



122385 LENKERTASCHE
›UTRECHT TRAVEL‹

30,90 €

- mit **Clip-on**-Halter (Art. 431523) passend für Ø **22,2 bis 31,8 mm**
- Volumen ca. 10 Liter
- **2 Zusatztaschen** und ein **isolierter Flaschenhalter**
- **Klarsichtfenster** für Landkarten
- Trage-/Schulterriemen
- Reflexstreifen

HANDLEBAR BAG
›UTRECHT TRAVEL‹

- with **clip-on** bracket (art. 431523) for Ø **22.2 up to 31.8 mm**
- volume approx. 10 litres
- **2 additional bags** and one **insulated bottle holder**
- **window pocket** for maps
- carrying-/shoulder strap
- reflective stripes



122819 LENKERTASCHE
›UTRECHT TRAVEL ECO‹

9,90 €



- Befestigung mit zwei **universell versetzbaren** Klettverschlüssen an **Rollern**, Fahrrädern, ...
- innen mit zusätzlicher Versteifung
- mit Reflexaufdruck
- Größe ca. 22 x 10 x 16 cm (L x B x H)

HANDLEBAR BAG
›UTRECHT TRAVEL ECO‹

- mounting with two **universally displaceable** hook and loop fasteners on **scooters**, bicycles, ...
- additional internal stiffness
- with reflective print
- size approx. 22 x 10 x 16 cm (L x W x H)



122342 LENKERTASCHE
›AMSTERDAM BOTTLE ISO‹

8,90 €



- mit **isolierender Innenschicht**
- **universelle, werkzeuglose** Anbringung am Lenker, Vorbau, Rahmenrohr, ...
- rutschsichere Klettbefestigung
- universelle Einsatzbereiche z. B. für Trinkflaschen, Werkzeuge, ...
- mit Reflexlogo
- mit Kordelzugverschluss

HANDLEBAR BAG
›AMSTERDAM BOTTLE ISO‹

- with **insulating inner layer**
- **universal, toolless** mounting on the handlebar, handle stem, frame tube, ...
- non-slip hook and loop straps
- universal applications e. g. for water bottles, tools, ...
- with reflective logo
- with drawstring fastener



ART.-NR. **BESCHREIBUNG**
UVP

DESCRIPTION

122396 SMARTPHONE TASCHE
›EINDHOVEN SC 1‹

14,90 €

XL
360°

- Handy durch großes, transparentes Sichtfenster **bedienbar**
- erschütterungsabsorbierende, weiche **Polstereinlage**
- wasserabweisend
- passend für alle gängigen iPhones und Smartphones, z. B. iPhone 12 Pro Max
- Größe: ca. 180 x 85 x 30 mm (L x B x H)
- **drehbarer Clip-on-Halter** für Ø 22,0 bis 40 mm
- auf M-Wave Eurolochkarte

SMARTPHONE BAG
›EINDHOVEN SC 1‹

- mobile phone **operable** through large, transparent screen
- shock absorbing, soft **padding**
- water-repellent
- suitable for all popular iPhones and smartphones, e. g. iPhone 12 Pro Max
- size: approx. 180 x 85 x 30 mm (L x W x H)
- **turnable clip-on** bracket for Ø 22.0 up to 40 mm
- on M-Wave eurohole card



122584 SMARTPHONEHALTER
›BIKE MOUNT AL‹

14,90 €

90°

- **Aluminium**
- **90° drehbare Lenkerhalterung** für Ø 22,2 - 31,8 mm
- **stufenlos einstellbar** von 60 - 95 mm
- inkl. Softpads zum Schutz des Smartphones
- in M-Wave Eurolochbox

SMARTPHONE BRACKET
›BIKE MOUNT AL‹

- **aluminium**
- **90° turnable bracket** up to Ø 22.2 - 31.8 mm
- **infinitely adjustable** up to 60 - 95 mm
- incl. Softpads to protect the smartphone
- in M-Wave eurohole box



122580 HALTER FÜR MOBILE
ENDGERÄTE
›BIKE MOUNT FLEX‹

11,90 €

360°



- **universelle 360° drehbare** Halterung
- universell passend für ca. **3,5" - 6,5" Displaygröße**
- aus **elastischem, rutschhemmendem Silikon**
- schnelle werkzeuglose Montage am Lenker, Vorbau, ... durch Silikonhalter
- in M-Wave Eurolochbox

BRACKET FOR MOBILE DEVICES
›BIKE MOUNT FLEX‹

- **universal 360° turnable** bracket
- universally suitable for approx. **3.5" - 6.5" display size**
- made of **elastic, non-slip silicone**
- quick, toolless mounting to the handlebar, handle stem, ... by silicone bracket
- in M-Wave eurohole box

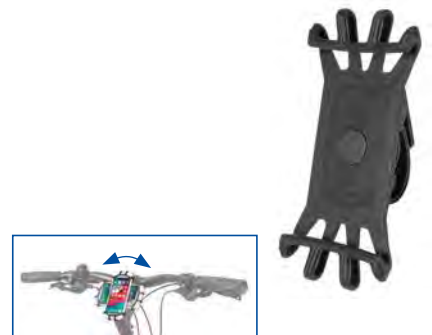

122405 SMARTPHONE HALTER
›EINDHOVEN GRIP‹

8,90 €

360°



- erschütterungsabsorbierende, weiche **Polstereinlage**
- **werkzeuglos** verstellbare Auflagefläche
- passend für fast alle gängigen iPhones und Smartphones
- Auflagefläche: ca. 110 x 55 x 11 mm bis 126 x 72 x 11 mm (L x B x H)
- **360° stufenlos drehbarer Clip-on-Halter** für Ø 21 bis 32 mm, **werkzeuglose** Montage
- auf M-Wave Eurolochkarte

SMARTPHONE BRACKET
›EINDHOVEN GRIP‹

- shock absorbing, soft **padding**
- **toolless** adjustable contact area
- suitable for almost all iPhones and smartphones
- contact area: approx. 110 x 55 x 11 mm up to 126 x 72 x 11 mm (L x W x H)
- **360° steplessly turnable clip-on** bracket for Ø 21 up to 32 mm, **toolless** mounting
- on M-Wave eurohole card



122411 HALTER FÜR MOBILE
ENDGERÄTE
›EINDHOVEN GRIP EDGE‹

9,90 €

360°



- aus stabilem ABS-Kunststoff
- **universelle** Größenanpassung (55 x 116 x 12 mm bis 90 x 180 x 12 mm)
- passend für viele mobile Endgeräte
- **360° drehbar**, mit Fixierfunktion
- mit Moosgummi-Einlage zur individuellen Anpassung und Stoßabsorption
- für Lenkerdurchmesser 22,2 - 31,8 mm
- **werkzeuglos** montierbar
- in M-Wave Eurolochbox

BRACKET FOR MOBILE DEVICES
›EINDHOVEN GRIP EDGE‹

- made of stable ABS plastic
- **universal** size adjustment (55 x 116 x 12 mm to 90 x 180 x 12 mm)
- suitable for many mobile devices
- **360° turnable**, with fixing function
- with foam rubber inlay for individual size adaptation and shock absorption
- for handlebar diameter 22.2 - 31.8 mm
- **toolless** mounting
- in M-Wave eurohole box



ART.-NR. UVP	BESCHREIBUNG	DESCRIPTION	
	<p>M-WAVE SMART SCHALEN – GARANTIERT SICHER!</p> <ul style="list-style-type: none"> • viele Kombinationsmöglichkeiten von Haltern und Hüllen • verschiedene Montagepositionen für optimale Sicht auf Ihr Smartphone • in Deutschland produziert 	<p>M-WAVE SMART SHELLS – GUARANTEED SAFE!</p> <ul style="list-style-type: none"> • a lot of potential combinations of brackets and shells • various mounting positions for an optimized view to your smartphone • made in Germany 	<p>MADE IN GERMANY</p> 
<p>122576 122699 9,90 €</p>	<p>ADAPTER FÜR GARMIN</p> <ul style="list-style-type: none"> • für 4QuickFix-Systeme • Adapter für Garmin eTrex, DakotaTM, Oregon, Approach, Astro, GPSMAP (kein original Garmin Ersatzteil) <p>auf M-Wave Eurolochkarte</p> <p>Montageverpackung</p>	<p>ADAPTER FOR GARMIN</p> <ul style="list-style-type: none"> • for 4QuickFix systems • adapter for Garmin eTrex, DakotaTM, Oregon, Approach, Astro, GPSMAP (no original Garmin spare part) <p>on M-Wave eurohole card</p> <p>OEM</p>	
<p>AUTO</p> <p>122569 122693 15,90 €</p>	<p>HALTER FÜR NAVIGATIONS-GERÄTE ›AUTO NAVI FIX‹</p> <ul style="list-style-type: none"> • passend für viele Automobil-Navigationsgeräte (z. B. von TomTom, Becker, Magellan, Garmin, Blaupunkt, Navman, Medion, Navigon, Falk, VDO/Dayton, ...) • mit 4QuickFix-Aufnahme • für Geräte von 59 bis 89 mm Höhe • bewegliche Stützstege <p>auf M-Wave Eurolochkarte</p> <p>Montageverpackung</p>	<p>BRACKET FOR NAVIGATION SYSTEMS ›AUTO NAVI FIX‹</p> <ul style="list-style-type: none"> • suitable for many car navigation systems (e.g. by TomTom, Becker, Magellan, Garmin, Blaupunkt, Navman, Medion, Navigon, Falk, VDO/Dayton, ...) • with 4QuickFix receiver • for gadgets from 59 to 89 mm height • movable support rods <p>on M-Wave eurohole card</p> <p>OEM</p>	
<p>122691 16,90 €</p> <p>M</p> <p>90°</p>	<p>SMARTPHONE HARTSCHALE ›BIKE MOUNT HC M‹</p> <ul style="list-style-type: none"> • spritzwassergeschützt • touch sensitive Folie mit Entspiegelungsfunktion • für Smartphones bis 145 x 78 x 13,4 mm (z. B. für Galaxy S6, Galaxy S6 Edge, iPhone 6S, P8, iPhone 11 Pro, iPhone SE, Xperia Z, ...) • Kabeldurchführung für Kopfhörer und Ladekabel • schlagfestes, witterungsbeständiges und rutschfestes Material • mit 4QuickFix-Aufnahme • 90° drehbar • Montageverpackung 	<p>SMARTPHONE HARD CASE ›BIKE MOUNT HC M‹</p> <ul style="list-style-type: none"> • water protected • touch sensitive window with anti-reflection function • For smartphones to 145 x 78 x 13.4 mm (e. g. for Galaxy S6, Galaxy S6 Edge, iPhone 6S, P8, iPhone 11 Pro, iPhone SE, Xperia Z, ...) • cable lead through for earphones and charging cables • impact resistant, weatherproof and non-slip material • with 4QuickFix receiver • 90° turnable • OEM 	
<p>122215 19,90 €</p> <p>XL</p> <p>RESISTANT</p>	<p>OBERROHRTASCHE ›ROTTERDAM TOP XL SC‹</p> <ul style="list-style-type: none"> • mit Blendschutz für bessere Sichtbarkeit des Smartphone-displays • sichere Befestigung mit Klettverschlüssen • Touchdisplay durch wassergeschütztes, transparentes Sichtfenster bedienbar • Reflektoren an den Seiten • zusätzlich mit universeller Regenschutzhaube • Größe: ca. 18,5 x 9,5 x 8,5 mm (L x B x H) 	<p>TOP TUBE BAG ›ROTTERDAM TOP XL SC‹</p> <ul style="list-style-type: none"> • with glare protection for better visibility of the smartphone display • secure mounting with hook and loop fasteners • touchpad usable through water protected, transparent top window pocket • reflective stripes on the sides • additionally with universal rain cover • size: approx. 18.5 x 9.5 x 8.5 mm (L x W x H) 	 

Bags

ART.-NR. BESCHREIBUNG
UVP

DESCRIPTION

122376 OBERROHRTASCHE
›ROTTERDAM TOP SB‹

14,90 €

XXL

- sichere Befestigung mit 3 Klettverschlüssen
- verstärkter Boden
- erschütterungsabsorbierende, weiche **Polstereinlage**
- wasserabweisendes Material und Reißverschlüsse
- großes Hauptfach, durch Netz unterteilt
- **zwei ausklappbare, erweiterbare Seitentaschen**
- Toptasche mit zwei Innenfächern für **iPhone, Smartphone, GPS-Geräte, ...**
- Touchdisplay durch **wassergeschütztes, transparentes Sichtfenster** bedienbar
- Größe: ca. 18,5 x 11 x 13 cm (L x B x H), zusätzliche Seitentaschen ausgeklappt ca. 12 x 14 x 3 cm

TOP TUBE BAG
›ROTTERDAM TOP SB‹

- secure mounting with 3 hook and loop fasteners
- reinforced bottom
- shock absorbing soft **padding**
- water-repellent material and zipper
- large main compartment, separated inside by a net
- **two foldable, extendable side bags**
- top pocket with two inner pockets for **iPhone, smartphone, GPS device, ...**
- touchpad usable through **water protected, transparent top window pocket**
- size: approx. 18.5 x 11 x 13 cm (L x W x H), additional extended side pockets approx. 12 x 14 x 3 cm



122377 OBERROHRTASCHE
›ROTTERDAM TOP SOUND‹

15,90 €

XL



- mit **integriertem Lautsprecher**
- Anschluss passend für **Smartphones, iPhones, iPods, MP3-Player** (3,5 mm Klinkestecker)
- sichere Befestigung mit 3 Klettverschlüssen
- verstärkter Boden
- erschütterungsabsorbierende, weiche **Polstereinlage**
- wasserabweisendes Material und Reißverschlüsse
- Touchdisplay durch **wassergeschütztes, transparentes Sichtfenster** bedienbar
- passend für **große iPhones und Smartphones**
- Größe: ca. 18 x 9 x 9 cm (L x B x H)

TOP TUBE BAG
›ROTTERDAM TOP SOUND‹

- with **integrated speaker**
- port suitable for **smartphones, iPhones, iPods, MP3 player** (3.5 mm stereo jack)
- secure mounting with 3 hook and loop fasteners
- reinforced bottom
- shock absorbing, soft **padding**
- water-repellent material and zipper
- touchpad usable through **water protected, transparent top window pocket**
- suitable for **bigger iPhones and smartphones**
- size: approx. 18 x 9 x 9 cm (L x W x H)



XL

OBERROHRTASCHE
›ROTTERDAM TOP XL‹

- sichere Befestigung mit 3 Klettverschlüssen
- verstärkter Boden
- erschütterungsabsorbierende, weiche **Polstereinlage**
- wasserabweisendes Material und Reißverschlüsse
- Touchdisplay durch **wassergeschütztes, transparentes Sichtfenster** bedienbar
- Reflektoren an den Seiten
- passend für große **Smartphones**, wie z. B. iPhone X
- Größe: **ca. 18,5 x 9,5 x 8,5 cm** (L x B x H)

TOP TUBE BAG
›ROTTERDAM TOP XL‹

- secure mounting with 3 hook and loop fasteners
- reinforced bottom
- shock absorbing, soft **padding**
- water-repellent material and zipper
- touchpad usable through **water protected, transparent top window pocket**
- reflective stripes on the sides
- suitable for bigger **Smartphones** like e. g. iPhone X
- size: **approx. 18.5 x 9.5 x 8.5 cm** (L x W x H)



122372 schwarz

8,90 €

- 122210**
- wasserabweisendes Material in **Echtlederoptik**
 - Ergänzung zur Gepäckträgertasche Amsterdam Double L (Art. 122317)

10,90 €

black

- water-repellent material in **genuine leather appearance**
- in addition to bicycle carrier bag Amsterdam Double L (art. 122317)



ART.-NR. UVP **BESCHREIBUNG**

DESCRIPTION



OBERROHRTASCHE

›ROTTERDAM TOP L‹

- sichere Befestigung mit 3 Klettverschlüssen
- verstärkter Boden
- erschütterungsabsorbierende, weiche **Polstereinlage**
- wasserabweisendes Material und Reißverschlüsse
- Touchdisplay durch **wassergeschütztes, transparentes Sichtfenster** bedienbar
- Reflektoren an den Seiten
- passend für **Smartphones**
- Größe: ca. 17,5 x 8 x 8,5 cm (L x B x H)

TOP TUBE BAG

›ROTTERDAM TOP L‹

- secure mounting with 3 hook and loop fasteners
- reinforced bottom
- shock absorbing, soft **padding**
- water-repellent material and zipper
- touchpad usable through **water protected, transparent top window pocket**
- reflective stripes on the sides
- suitable for **smartphones**
- size: approx. 17.5 x 8 x 8.5 cm (L x W x H)



122375 schwarz

black

122552 weiß

white

122553 rot

red

122554 blau

blue

122555 grün

green

122556 gelb

yellow

122557 orange

orange

122558 pink

pink

6,90 €

122366 DREIECKSTASCHE

5,90 €

›ROTTERDAM TRI‹

- Befestigung mit 3 Klettverschlüssen
- **Reflektoren** an den Seiten
- mit **Polsterung** zum leichten Tragen des Fahrrads

TRIANGLE BAG

›ROTTERDAM TRI‹

- fixation with 3 hook and loop fasteners
- **reflective stripes** on the sides
- with **soft padding** for easy carrying the bike



122830 FLASCHENHALTER-TASCHE

13,90 €

›GRONINGEN BC‹

- inkl. **Aluminium-Adapter** zur Befestigung an den Flaschenhalterösen (unter dem Flaschenhalter)
- **wasserdicht**
- mit Innentasche für z. B. Kettenverschlussglieder, ...
- Tasche kann leicht (de-)montiert werden
- Adapter kann auch nur mit Klettbindern (z. B. Art. 340042) genutzt werden
- Größe: ca. 11,0 x 7,5 x 6,5 cm (L x B x H)
- auf M-Wave Eurolochkarte

BOTTLE CAGE BAG

›GRONINGEN BC‹

- incl. **aluminium adapter** for mounting to the bottle cage eyelets (below the bottle cage)
- **waterproof**
- with inner bag for e. g. chain links, ...
- bag can easily be (de-)mounted
- bracket can also be used only with hook and loop straps (e. g. art. 340042)
- size: approx. 11.0 x 7.5 x 6.5 cm (L x W x H)
- on M-Wave eurohole card

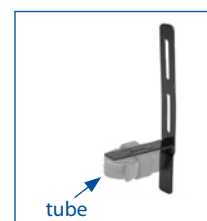

ART.-NR. UVP	BESCHREIBUNG	DESCRIPTION	
122831 13,90 €	SATTELTASCHE ›AMSTERDAM BOTTLE‹ <ul style="list-style-type: none"> • geräumiges Hauptfach mit großer Öffnung • mit Trinkflaschenhalterfach • sichere Befestigung mit vier universell anpassbaren Klettverschlüssen • mit Rücklichthalterschlaufe • mit Reflexaufdruck • Größe ca. 9,5 x 10 x 27 cm (L x B x H) • mit M-Wave Anhänger 	SADDLE BAG ›AMSTERDAM BOTTLE‹ <ul style="list-style-type: none"> • spacious main compartment with large opening • with bottle holder pocket • secure mounting with four universally adjustable hook and loop fasteners • with rear light bracket strap • with reflective print • size approx. 9.5 x 10 x 27 cm (L x W x H) • with M-Wave tag 	  
122339 19,90 €	SATTELTASCHE ›TILBURG L ILLU‹ <ul style="list-style-type: none"> • mit integriertem LED-Ringlicht, aufladbar über USB-Kabel (inkl.) • einfache, werkzeuglose Montage mit T-Halter für Sattelgestell und Klettverschluss für Sattelstütze • durch Reißverschluss nach unten erweiterbar • mit Haltenetz unten (z. B. für Luftpumpe) • mit Reflexaufdruck • Größe: ca. 180 x 115 mm • Höhe: ca. 105 - 180 mm • auf M-Wave Eurolochkarte 	SADDLE BAG ›TILBURG L ILLU‹ <ul style="list-style-type: none"> • with integrated LED light, rechargeable by USB cable (incl.) • easy, toolless mounting with T-bar for saddle rail and hook and loop strap for seat post • through zipper expandable at the bottom • with mesh net at the bottom (e. g. for pump) • with reflective print • size: approx. 180 x 115 mm • height: approx. 105 - 180 mm • on M-Wave eurohole card 	  
	Ohne deutsches Prüfzeichen - Verkauf und Nutzung im Geltungsbereich der StVZO (Deutschland) unzulässig (Abgabe nur an außerdeutsche Kunden).		
	SATTELTASCHE ›TILBURG L‹ <ul style="list-style-type: none"> • mit Clip-on-Halter (Art. 122299) • durch Reißverschluss nach unten erweiterbar • mit Rücklichthalter und Klettriemen unten (z. B. für Luftpumpe) • mit Reflexaufdruck • Größe: ca. 180 x 115 mm • Höhe: ca. 105 - 180 mm 	SADDLE BAG ›TILBURG L‹ <ul style="list-style-type: none"> • with clip-on bracket (art. 122299) • through zipper expandable at the bottom • with light bracket and hook and loop fasteners at the bottom (e. g. for pump) • with reflective print • size: approx. 180 x 115 mm • height: approx. 105 - 180 mm 	 
122360	schwarz	black	
122482	weiß	white	
122483	rot	red	
122484	blau	blue	
122485	grün	green	
122488	pink	pink	
6,90 €			
122357 6,90 €	SATTELTASCHE ›TILBURG M‹ <ul style="list-style-type: none"> • Größe: ca. 187 x 60 mm • Höhe: ca. 95 - 150 mm 	SADDLE BAG ›TILBURG M‹ <ul style="list-style-type: none"> • size: approx. 187 x 60 mm • height: approx. 95 - 150 mm 	
	SATTELTASCHE ›TILBURG S‹ <ul style="list-style-type: none"> • Befestigung mit Riemen und Klettverschlüssen • mit Reflexstreifen (als Lichthalter verwendbar) 	SADDLE BAG ›TILBURG S‹ <ul style="list-style-type: none"> • attachment with straps and hook and loop fasteners • with reflective stripe (useable as light bracket) 	

ART.-NR. UVP **BESCHREIBUNG**

DESCRIPTION

122529 LAUFRADTASCHE ›ROTTERDAM WSB DOUBLE‹

61,90 €

2x 29"
4x 700C

- für **2 Laufräder bis 29"**
- Tasche durch Reißverschluss **in zwei Einzeltaschen unterteilbar** (auch einzeln verwendbar)
- Durchmesser 76 cm
- **gepolstert**
- inkl. **Schutzscheiben** für die Naben
- **Innentasche** für Schnellspanner
- mit Tragegriff und **Schultergurt**
- mit beschriftbarem **Namensanhänger**

WHEEL BAG ›ROTTERDAM WSB DOUBLE‹

- for **2 wheels up to 29"**
- zippered bag **dividable into two single bags** (can also be used separately)
- diameter 76 cm
- **padded**
- incl. **protection discs** for the hubs
- **inner pocket** for the QRs
- with handle and **shoulder strap**
- with inscribable **name tag**



LAUFRADTASCHE ›ROTTERDAM WSB‹

- **gepolstert**
- inkl. **2 Schutzscheiben** für die Naben
- **Innentasche** für Schnellspanner
- mit Tragegriff

WHEEL BAG ›ROTTERDAM WSB‹

- **padded**
- incl. **2 protection discs** for the hubs
- **inner pocket** for the QRs
- with handle



122533 Durchmesser 83 cm, für Räder bis 29" und besonders breite 26" Laufräder

26,90 €

diameter 83 cm, for wheels **up to 29"** and extra wide 26" wheels

122530 Durchmesser 76 cm, für Räder bis 28"

21,90 €

diameter 76 cm, for wheels **up to 28"**

122400 ANTRIEBSSCHUTZTASCHE ›ROTTERDAM PROTECT‹

9,90 €

- optimaler Schutz für die Fahrrad-antriebseinheit im **Auto, Flugzeug, ...**
- **Schmutzschutz** auf dem **Fahrrad-träger**
- passend für alle gängigen Kombi-nationen von Kettenradgarnituren, Umwerfern, Kassetten, Schaltwerk, ...
- auf M-Wave Eurolochkarte

DRIVE UNIT PROTECTION BAG ›ROTTERDAM PROTECT‹

- optimum drive unit protection during transport in **cars, aeroplanes, ...**
- **dirt protection** during transport on a **car bike carrier**
- fits for all usual combinations of crank-sets, front derailleurs, cassettes, rear derailleurs, ...
- on M-Wave eurohole card



122900 PEDALTASCHE ›ROTTERDAM PEDAL P‹

10,90 € / pair

- **2 Taschen für 1 Paar Pedale**
- aus Neopren
- als **Transporttaschen oder zum Schutz am Rad** verwendbar
- ca. 135 x 145 mm
- 1 Paar auf M-Wave Eurolochkarte

PEDAL BAG ›ROTTERDAM PEDAL P‹

- **2 bags for 1 pair of pedals**
- made of neoprene
- suitable as **transport bags or as protection on the bike**
- approx. 135 x 145 mm
- 1 pair on M-Wave eurohole card



122795 FAHRRADKOFFER ›ROTTERDAM BIG BOX‹

439,00 €

- sehr **robuste Ausführung**
- innen **gepolstert**
- **abschließbar**
- mit seitlichen Verschlüssen (Art. 122796)
- mit **2 Laufradtaschen**
- mit **Werkzeugetasche**
- Größe: ca. 110/100 x 29 x 79/75 cm (L x B x H)
- mit 2 integrierten/geschützten Rollen hinten (Art. 122797)
- mit 2 lenk-/drehbaren Rollen vorne (Art. 122798)
- inkl. Zieh- und Tragegriff

BIKE CASE ›ROTTERDAM BIG BOX‹

- pretty **robust design**
- inner **foam padding**
- **lockable**
- with replacement lock (art. 122796)
- with **2 wheel bags**
- with **tool pocket**
- size approx. 110/100 x 29 x 79/75 cm (L x W x H)
- with 2 integrated/protected pulleys at the back (art. 122797)
- with 2 front pulleys, dirigible and turnable (art. 122798)
- incl. pulling and carrying handle



ART.-NR. **BESCHREIBUNG**
UVP

DESCRIPTION

**BIKER SPEZIAL-RUCKSACK
>BP BACK<**

- **gepolsterte, atmungsaktive Schultertragegurte und Beckengurt**
- zusätzlicher, verstellbarer Brustgurt
- Tragegestell und anpassbares Rückenetzteil für **optimal belüfteten Tragekomfort**
- **integrierter Regenüberzug**
- mit **Reflexaufdruck**
- **inkl. abnehmbarem Helmaufbewahrungsnetz**
- 1 Hauptfach und 4 kleinere Fächer mit Reißverschluss
- integriertes, **isoliertes** Fach für **Trinkblase**
- zusätzlich 2 äußere Fächer und 1 großes Innenfach
- mit Rücklichthalter
- Volumen ca. 15 Liter
- ca. 46 x 28 x 12 cm

**BIKER SPECIAL BACKPACK
>BP BACK<**

- **padded, breathable shoulder straps and waist belt**
- additional, adjustable chest belt
- carrying structure and adaptable back net for **optimally ventilated wearing comfort**
- **integrated rain cover**
- with **reflective print**
- **incl. detachable helmet storage net**
- 1 main compartment and 4 smaller pockets with zipper
- integrated **insulated** compartment for **water bag**
- additionally 2 outer compartments and 1 big inner compartment
- with rear light strap
- volume approx. 15 litres
- approx. 46 x 28 x 12 cm



122634 schwarz / blau

black / blue

122635 neongelb, **besonders gute Sichtbarkeit durch leuchtende Farbe und Reflexaufdruck**
45,90 €

neon yellow, **very good visibility due to bright colour and reflective print**



122536 FALTRUCKSACK >DELUXE<

23,90 €

FOLD

287 g

- nur 287 g
- zusammengefoldet nur 16 x 11 x 8 cm (L x B x H), aufgefaltet ca. 49 x 28 x 13 cm
- Volumen ca. 20 Liter
- **3 Fächer** mit Reißverschluss: Haupt-, Front- und Innenfach (das gleichzeitig als Tasche für den gefalteten Rucksack dient)
- **Helmfach** mit drei justierbaren Klippverschluss-Gurten
- **2 elastische Außennetztaschen** (für Trinkflaschen, ...)
- leicht gepolstertes Rückenteil
- justierbare, leicht gepolsterte Schultergurte mit 2 x 3 Organizer-Laschen
- zusätzlicher **Brustgurt** für perfekten Sitz
- mit Befestigungsclips für Rahmen, Sattelgestell, ...

FOLDABLE BACKPACK >DELUXE<

- only 287 g
- folded size only 16 x 11 x 8 cm (L x W x H), unfolded approx. 49 x 28 x 13 cm
- volume approx. 20 litres
- **3 compartments** with zipper: main, front and inner compartment (which is also the storage bag for the folded backpack)
- **helmet case** with 3 adjustable clip belts
- **2 elastic outer net pockets** (for bottles, ...)
- slightly padded back part
- adjustable, slightly padded shoulder straps with 2 x 3 organizer clips
- additional **chest belt** for perfect fit
- with fixing clips for frames, saddle rails, ...



**122352 TASCHEN + KORBÜBERZUG
>MAASTRICHT PROTECT<**

10,90 €

- **universeller** Regenschutz für **Rucksäcke** bis ca. 25 Liter, **Körbe**, Vorderradtaschen, Gepäcktaschen, ...
- mit **2 Haltegurten** auf der Rückseite
- neongelb
- **3M Scotchlite® Reflexstreifen** auf drei Seiten
- mit aufgesetzter Netztasche
- auf M-Wave Eurolochkarte

**BAG + BASKET COVER
>MAASTRICHT PROTECT<**

- **universal** rain protection for **backbags** up to approx. 25 litres, **baskets**, front bags, rear bags, ...
- with **2 fixation straps** on back
- neon yellow
- **3M Scotchlite® reflective stripes** on three sides
- with fitted net pocket
- on M-Wave eurohole card



ART.-NR. UVP	BESCHREIBUNG	DESCRIPTION
122500 36,90 €	TRINKRUCKSACK ›MAASTRICHT H₂O‹ <ul style="list-style-type: none"> • 2-Liter-Wasserblase von SOURCE mit antibakterieller Innenbeschichtung (Art. 122515) • große Reinigungsöffnung • Trinkschlauch mit auswechselbarem, drehbarem Clip-on-Mundstück (Art. 122516) • isoliertes Fach • mit Reflexstreifen • mit 2 Zusatztaschen • Volumen: ca. 6 Liter 	WATER BACKPACK ›MAASTRICHT H₂O‹ <ul style="list-style-type: none"> • 2-litres-water bag from SOURCE with antimicrobial protection inside (art. 122515) • big opening for cleaning • drinking tube with exchangeable, turnable clip-on bite valve (Art. 122516) • insulated compartment • with reflective stripes • with 2 additional pockets • volume: approx. 6 litres
122503 17,90 €	Rucksack ohne Wasserblase und Trinkschlauch	backpack without water bag and drinking tube



Bags

122515 22,90 €	WASSERBLASE ›SOURCE‹ <ul style="list-style-type: none"> • 2-Liter-Wasserblase mit antibakterieller Innenbeschichtung • 2.000 % glattere Oberfläche als herkömmliche TPU-Folien beugt Schimmelbildung vor • große Öffnung für schnelles und leichtes Befüllen und Reinigen • geschmacksneutral und frei von BPA und Phthalaten • Trinkschlauch mit antibakterieller Innenbeschichtung und auswechselbarem Silikon-Mundstück (Art. 122516) • passend für Trinkrucksäcke, z. B. Art. 122503, 122634 	WATER BAG ›SOURCE‹ <ul style="list-style-type: none"> • 2-litres-water bag with antimicrobial protection inside • 2,000 % smoother surface than conventional TPU foils prevents mould formation • big opening for fast and easy filling and cleaning • tasteless and free from BPA and phthalates • drinking tube with antimicrobial protection inside and exchangeable silicone bite valve (art. 122516) • suitable for water backpacks, e. g. art. 122503, 122634
-------------------	---	--



SOURCE™



122381 7,90 €	OBERARMTASCHE ›MAASTRICHT ARM‹ <ul style="list-style-type: none"> • universell passend für viele Smartphones (170 x 120 mm) • drei Kopfhörerausgänge • mit elastischem Klettverschluss • transparentes Sichtfenster • auf M-Wave Eurolochkarte 	UPPER ARM BAG ›MAASTRICHT ARM‹ <ul style="list-style-type: none"> • universally suitable for many smartphones (170 x 120 mm) • 3 exits for ear-phones • with elastic hook and loop fastener • transparent window • on M-Wave eurohole card
------------------	---	---



M-WAVE

ART.-NR. BESCHREIBUNG
UVP

DESCRIPTION

220405 AKKULAMPE
›APOLLON K 1.1 USB‹

34,90 €

25 LUX



SILICONE



- 1 weiße **CREE** LED
- mit **deutschem Prüfzeichen**
- **wasserfestes Silikongehäuse**
- Helligkeit **25 Lux**
- aufladbar über **USB-Kabel** (inkl.)
- nur ca. 86 g
- **Lithium-Polymer-Schnelllade-Akku** (3,7 V / 900 mAh)
- Laufzeit: ca. 3 Stunden
- mit Batterie- und Ladezustandsanzeige
- integrierter **universeller Silikonhalter**
- **schnelle werkzeuglose** Montage, für Ø 22,2 - 32 mm
- auf M-Wave Eurolochkarte

RECHARGEABLE LAMP
›APOLLON K 1.1 USB‹

- 1 white **CREE** LED
- with **German approval number**
- **water resistant silicone housing**
- brightness **25 Lux**
- rechargeable by **USB cable** (incl.)
- only approx. 86 g
- **Lithium Polymer quick charge battery** (3.7 V / 900 mAh)
- running time: approx. 3 hours
- with battery level and charge control indicator
- integrated **universal silicone bracket**
- **quick toolless** mounting, for Ø 22.2 - 32 mm
- on M-Wave eurohole card



220404 AKKULAMPE
›APOLLON K 30 USB‹

19,90 €

30/15 LUX



- 1 weiße LED
- 2 Funktionen: maximale Beleuchtung, Energiesparmodus
- Helligkeit **30 / 15 Lux**
- mit **deutschem Prüfzeichen**
- 360° drehbarer Halter für Ø 19 - 35 mm (Art. 223559)
- schnelle werkzeuglose Montage
- mit Batterie- und Ladezustandsanzeige
- nur ca. 51 g
- **Lithium-Akku** (3,7 V / 1.200 mAh)
- Laufzeit: ca. 3,5 - 7 Stunden
- aufladbar über **USB-Kabel** (inkl.)
- in M-Wave Blisterverpackung

RECHARGEABLE LAMP
›APOLLON K 30 USB‹

- 1 white LED
- 2 functions: maximum illumination, power saving mode
- brightness **30 / 15 Lux**
- with **German approval number**
- 360° turnable bracket for Ø 19 - 35 mm (art. 223559)
- quick toolless mounting
- with battery level and charge control indicator
- only approx. 51 g
- **Lithium rechargeable battery** (3.7 V / 1,200 mAh)
- running time: approx. 3.5 - 7 hours
- rechargeable by **USB cable** (incl.)
- in M-Wave blister packaging



220421 AKKULAMPE
›APOLLON 20 USB‹

17,90 €

1 WATT



- 1 weiße **1 Watt** LED mit SST (**Soft Start Technology**)
- hochwertiges **Aluminiumgehäuse**
- 3 Funktionen (2x Dauer- und 1x Blinklicht)
- **Helligkeit bis zu 20 Lux, 95 Lumen**
- mit Batterie- und Ladezustandsanzeige
- Lithium-Akku (3,7 V / 600 mAh)
- Laufzeit: ca. 2 - 5 Stunden
- aufladbar über **USB-Kabel** (inkl.)
- Halter für Ø 22,2 - 35 mm (Art. 223551)
- werkzeuglose Montage
- nur ca. **54 g**
- auf M-Wave Eurolochkarte

RECHARGEABLE LAMP
›APOLLON 20 USB‹

- 1 white **1 Watt** LED with SST (**Soft Start Technology**)
- high quality **aluminium** housing
- 3 functions (2x steady and 1x flashing light)
- **brightness levels up to 20 Lux, 95 Lumen**
- with battery level and charge control indicator
- Lithium rechargeable battery (3.7 V / 600mAh)
- running time: approx. 2 - 5 hours
- rechargeable by **USB cable** (incl.)
- bracket for Ø 22.2 - 35 mm (art. 223551)
- toolless mounting
- only approx. **54 g**
- on M-Wave eurohole card



Ohne deutsches Prüfzeichen - Verkauf und Nutzung im Geltungsbereich der StVZO (Deutschland) unzulässig (Abgabe nur an außerdeutsche Kunden).

ART.-NR. BESCHREIBUNG
UVP

DESCRIPTION

220887

BATTERIELAMPE ›APOLLON A 1.2 3 WATT‹

BATTERY LAMP ›APOLLON A 1.2 3 WATT‹

11,90 €



- 1 weiße, **ultrahelle 3 Watt LED**
- **Aluminium**gehäuse
- 2 Funktionen (Dauer- und Blinklicht)
- Laufzeit: ca. 2 Stunden
- mit Dreh-Clip-on-Halter von Ø 22,2 - 31,8 mm (Art. 223541), werkzeuglose Montage
- auch als Minitaschenlampe verwendbar
- inkl. Batterien (4x AAA)
- in M-Wave Kunststoffbox

- 1 white, **ultra bright 3 Watt LED**
- **aluminium** housing
- 2 functions (steady and flashing light)
- running time: approx. 2 hours
- with twist clip-on bracket from Ø 22.2 - 31.8 mm (art. 223541), toolless mounting
- can also be used as a mini torch
- incl. batteries (4x AAA)
- in M-Wave plastic box



Ohne deutsches Prüfzeichen - Verkauf und Nutzung im Geltungsbereich der StVZO (Deutschland) unzulässig (Abgabe nur an außerdeutsche Kunden).

220998

BATTERIELAMPE ›APOLLON A 1.3 3 WATT‹

BATTERY LAMP ›APOLLON A 1.3 3 WATT‹

11,90 €



- 1 weiße **CREE** 3 Watt **Hochleistungs-LED**
- **Zoomfunktion: Ausleuchtungsbereich bis zu 2000-fach stufenlos verstellbar**
- 3 Funktionen (2x Dauer- und 1x Blinklicht)
- hochwertiges, gedichtetes **Aluminiumgehäuse**
- universeller QR-Clip-on-Halter Ø 20 - 28,6 mm (Art. 223514), werkzeuglose Montage
- auch als Minitaschenlampe verwendbar
- inkl. Batterien (3x AAA)
- in M-Wave Blisterverpackung

- 1 white **CREE** 3 Watt **high power LED**
- **zoom** function: **illumination area seamlessly adjustable up to 2000 times**
- 3 functions (2x steady and 1x flashing light)
- high quality sealed **aluminium housing**
- universal QR clip-on bracket Ø 20 - 28.6 mm (art. 223514), toolless mounting
- also usable as mini torch
- incl. batteries (3x AAA)
- in M-Wave blister packaging



Ohne deutsches Prüfzeichen - Verkauf und Nutzung im Geltungsbereich der StVZO (Deutschland) unzulässig (Abgabe nur an außerdeutsche Kunden).

220447

BATTERIELAMPE ›APOLLON K 1.2‹

BATTERY LAMP ›APOLLON K 1.2‹

10,90 €



- 1 weiße **Hochleistungs-LED**
- **Klartglasscheinwerfer**
- mit **deutschem Prüfzeichen**
- 2 Helligkeitsstufen: **30/15 Lux**
- Laufzeit: ca. 2 - 4 Stunden
- nur 49 g (ohne Batterien)
- mit Batteriezustandsanzeige
- mit QR-Clip-on-Halter (Art. 223515) von Ø 22,2 - 31,8 mm, werkzeuglose Montage
- inkl. Batterien (4x AAA)
- in M-Wave Blisterverpackung

- 1 white **super bright LED**
- **clear lense beam**
- with **German approval number**
- 2 brightness levels: **30/15 Lux**
- running time: approx. 2 - 4 hours
- only 49 g (w/o batteries)
- with battery level indicator
- with QR clip-on bracket (art. 223515) from Ø 22.2 - 31.8 mm, toolless mounting
- incl. batteries (4x AAA)
- in M-Wave blister packaging



220401

BATTERIELAMPE ›APOLLON 2‹

BATTERY LAMP ›APOLLON 2‹

8,90 €



- 1 weiße **1 Watt LED**
- **60 Lumen**
- 3 Funktionen (1x Dauer- und 2x Blinklicht)
- Laufzeit: ca. 10 - 20 Stunden
- mit QR-Clip-On Halter bis Ø 31,8 mm
- werkzeuglose Montage
- inkl. Batterien (3x AAA)
- auch als Minitaschenlampe verwendbar
- in M-Wave Blisterverpackung

- 1 white **1 Watt LED**
- **60 Lumen**
- 3 functions (1x steady and 2x flashing light)
- running time: approx. 10 - 20 hours
- with QR clip-on bracket up to Ø 31.8 mm
- toolless mounting
- incl. batteries (3x AAA)
- also useable as mini torch
- in M-Wave blister packaging



Ohne deutsches Prüfzeichen - Verkauf und Nutzung im Geltungsbereich der StVZO (Deutschland) unzulässig (Abgabe nur an außerdeutsche Kunden).

ART.-NR. BESCHREIBUNG
UVP

DESCRIPTION

220957 BATTERIELAMPE
›APOLLON 5.3‹

8,90 €



- **5 weiße Hochleistungs-LEDs**
- 3 Funktionen (1x Dauer- und 2x Blinklicht)
- extrem lange Leuchtdauer
- fokussierte Ausleuchtung durch **optische Linsen**
- mit QR-Clip-on-Halter von Ø 22,2 - 31,8 mm, werkzeuglose Montage
- auch als Minitaschenlampe verwendbar
- inkl. Batterien (3x AAA)
- in M-Wave Blisterverpackung

BATTERY LAMP
›APOLLON 5.3‹

- **5 white super bright LEDs**
- 3 functions (1x steady and 2x flashing light)
- extremely long run time
- focused illumination by **optical lenses**
- with QR clip-on bracket from Ø 22.2 - 31.8 mm, toolless mounting
- also useable as **mini torch**
- incl. batteries (3x AAA)
- in M-Wave blister packaging



Ohne deutsches Prüfzeichen - Verkauf und Nutzung im Geltungsbereich der StVZO (Deutschland) unzulässig (Abgabe nur an außerdeutsche Kunden).

220941 BATTERIELAMPE
›APOLLON A 9.1‹

6,90 €

- **9 weiße LEDs**
- hochwertiges, **gedichtetes Aluminiumgehäuse**
- mit Universal-Clip-on-Halter Ø 22,2 - 28 mm
- auch als **Minitaschenlampe** verwendbar
- inkl. Batterien (3x AAA)
- in M-Wave Blisterverpackung

BATTERY LAMP
›APOLLON A 9.1‹

- **9 white LEDs**
- high-quality, **sealed aluminium housing**
- with universal clip-on bracket Ø 22.2 - 28 mm
- also useable as **mini torch**
- incl. batteries (3x AAA)
- in M-Wave blister packaging



Ohne deutsches Prüfzeichen - Verkauf und Nutzung im Geltungsbereich der StVZO (Deutschland) unzulässig (Abgabe nur an außerdeutsche Kunden).

220942 BATTERIELAMPE
›APOLLON 4.3‹

7,90 €



- **4 weiße LEDs**
- 3 Funktionen (1x Dauer- und 2x Blinklicht)
- Universalhalter passend für Ø 22,2 bis 31,8 mm
- mit Ersatzgummi für Halter
- werkzeuglose Montage
- auch als **Minitaschenlampe** verwendbar
- inkl. Batterien (3x AAA)
- in M-Wave Blisterverpackung

BATTERY LAMP
›APOLLON 4.3‹

- **4 white LEDs**
- 3 functions (1x steady and 2x flashing light)
- universal bracket suitable for Ø 22.2 up to 31.8 mm
- with replacement rubber for bracket
- toolless mounting
- also useable as **mini torch**
- incl. batteries (3x AAA)
- in M-Wave blister packaging



Ohne deutsches Prüfzeichen - Verkauf und Nutzung im Geltungsbereich der StVZO (Deutschland) unzulässig (Abgabe nur an außerdeutsche Kunden).

220545 AKKULAMPE
›APOLLON DUAL 3.8 USB‹

16,90 €



18 g



90°



- **Front- und Rücklicht in einem: 2 weiße LEDs** vorne und **eine superhelle rote LED** hinten
- maximale Lichtleistung vorne: 60 Lumen
- **8 Funktionen** (5x Blinklicht und 3x Helligkeitsstufen der weißen LEDs)
- mit Memoryfunktion
- Lithium-Polymer Akku (3,7 V / 240 mAh)
- Laufzeit: ca. 1,5 - 6 Stunden
- nur **18 g**
- aufladbar über **USB-Kabel** (inkl.)
- Batterie- und Ladezustandsanzeige
- auch um **90° gedreht** montierbar
- universeller Klettverschlusshalter für Helm, Lenker, Rahmen, Sattelstütze, ...
- werkzeuglose Montage
- in M-Wave Blisterverpackung

RECHARGEABLE LAMP
›APOLLON DUAL 3.8 USB‹

- **front and rear light in one: 2 white LEDs** at the front and **one super bright red LED** at the back
- maximum light output at the front: 60 lumen
- **8 functions** (5x flashing light and 3x brightness levels of the white LEDs)
- with memory function
- rechargeable Lithium Polymer battery (3.7 V / 240 mAh)
- running time: approx. 1.5 - 6 hours
- only **18 g**
- rechargeable by **USB cable** (incl.)
- battery level and charge control indicator
- also mountable **turned by 90°**
- universal hook and loop fastener for helmet, handlebar, frame, seat tube, ...
- toolless mounting
- in M-Wave blister packaging

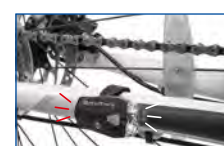

Ohne deutsches Prüfzeichen - Verkauf und Nutzung im Geltungsbereich der StVZO (Deutschland) unzulässig (Abgabe nur an außerdeutsche Kunden).

ART.-NR. UVP **BESCHREIBUNG**

DESCRIPTION

220572 AKKURÜCKLICHT ›HELIOS K 1.1 USB‹

18,90 €



- 1 rote **Hochleistungs-LED**
- mit **deutschem Prüfzeichen**
- schwarzes **Silikongehäuse**
- aufladbar über **USB-Kabel** (inkl.)
- integrierter **universeller Silikonhalter**
- **schnelle werkzeuglose** Montage
- mit Lithium-Ionen Akku (3,7 V / 160 mAh)
- mit Batterie- und Ladezustandsanzeige
- in M-Wave Blisterverpackung

RECHARGEABLE REAR LIGHT ›HELIOS K 1.1 USB‹

- 1 red **high power LED**
- with **German approval number**
- black **silicone housing**
- rechargeable by **USB cable** (incl.)
- integrated **universal silicone bracket**
- **quick toolless** mounting
- with rechargeable Lithium Ion battery (3.7 V / 160 mAh)
- with battery level and charge control indicator
- in M-Wave blister packaging



220559 AKKURÜCKLICHT ›HELIOS K 1.1 USB SL‹

10,90 €



- 1 rote **LED**
- mit **deutschem Prüfzeichen**
- Halter für Ø 19 - 35 mm (Art. 223561)
- Winkel des Halters einstellbar
- **240°** Abstrahlwinkel
- **klein aber fein**, nur **11 g** (ohne Halter)
- schnelle werkzeuglose Montage
- mit Batterie- und Ladezustandsanzeige
- aufladbar über **USB-Kabel** (inkl.)
- **Lithium-Polymer Akku** (3,7 V / 240 mAh)
- Laufzeit: ca. 4 Stunden
- in M-Wave Blisterverpackung

RECHARGEABLE REAR LIGHT ›HELIOS K 1.1 USB SL‹

- 1 red **LED**
- with **German approval number**
- bracket for Ø 19 - 35 mm (art. 223561)
- adjustable angle of the bracket
- **240°** illumination angle
- **small but mighty**, only **11 g** (without bracket)
- quick toolless mounting
- with battery level and charge control indicator
- rechargeable by **USB cable** (incl.)
- **rechargeable Lithium Polymer battery** (3.7 V / 240 mAh)
- running time: approx. 4 hours
- in M-Wave blister packaging



221037 BATTERIEBLINKLICHT ›HELIOS 2.3‹

8,90 €



- **2x 0,5-Watt ultrahelle Superflash-LEDs**
- 3 Funktionen (1x Dauer- und 2x Blinklicht)
- mit Universalschelle für Sattelstützen von Ø 25,4 - 31,8 mm
- **90° drehbar**
- werkzeuglose Montage
- inkl. Batterien (2x AAA)
- in M-Wave Blisterverpackung

BATTERY FLASHING LIGHT ›HELIOS 2.3‹

- **2x 0.5-Watt superbright flash LEDs**
- 3 functions (1x steady and 2x flashing light)
- with universal bracket for seat posts from Ø 25.4 - 31.8 mm
- **90° turnable**
- toolless mounting
- incl. batteries (2x AAA)
- in M-Wave blister packaging



Ohne deutsches Prüfzeichen - Verkauf und Nutzung im Geltungsbereich der StVZO (Deutschland) unzulässig (Abgabe nur an außerdeutsche Kunden).

220513 BATTERIEBREMSLICHT ›HELIOS BRAKE‹

6,90 €



- 1 superhelle rote LED
- **leuchtet beim Zug des Bremshebels auf**
- 3 Funktionen (Blink-, Dauer- und Bremslicht)
- für **Rennrad- und V-Bremse** geeignet
- **werkzeuglose Montage**
- inkl. Batterie (CR 2032)
- in M-Wave Blisterverpackung

BATTERY BRAKE LIGHT ›HELIOS BRAKE‹

- 1 super bright red LED
- **lights up by the pull of the brake lever**
- 3 functions (flashing, steady and brake light)
- suitable for **road and V-brake**
- **toolless mounting**
- incl. battery (CR 2032)
- in M-Wave blister packaging

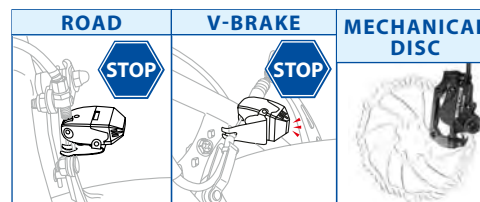

Ohne deutsches Prüfzeichen - Verkauf und Nutzung im Geltungsbereich der StVZO (Deutschland) unzulässig (Abgabe nur an außerdeutsche Kunden).

ART.-NR. UVP **BESCHREIBUNG**

DESCRIPTION

221041 BATTERIEBLINKLICHT

›HELIOS 3.2 S‹

BATTERY FLASHING LIGHT

›HELIOS 3.2 S‹

6,90 €

0,5 WATT

90°



- **3 rote LEDs, davon eine 0,5 Watt Hochleistungs-LED mit Superflash-Funktion** für exzellente Sichtbarkeit
- 2 Funktionen (Dauer- und Blinklicht)
- universeller, **90° drehbarer und winkelverstellbarer** Halter für Sattelstütze von Ø 25,4 - 31,8 mm
- werkzeuglose Montage
- inkl. Batterien (2x AAA)
- in M-Wave Blisterverpackung

- **3 red LEDs, thereof one 0.5 Watt high power LED with superflash function** for excellent visibility
- 2 functions (steady and flashing light)
- universal, **90° turnable and angle adjustable** bracket for seat post from Ø 25.4 - 31.8 mm
- toolless mounting
- incl. batteries (2x AAA)
- in M-Wave blister packaging



Ohne deutsches Prüfzeichen - Verkauf und Nutzung im Geltungsbereich der StVZO (Deutschland) unzulässig (Abgabe nur an außerdeutsche Kunden).

220569 BATTERIERÜCKLICHT

›HELIOS K 1.1‹

BATTERY REAR LIGHT

›HELIOS K 1.1‹

6,90 €



- 1 rote **Hochleistungs-SMD-LED**
- Universalhalter passend für Ø 25,4 - 31,8 mm (Art. 223516)
- mit **deutschem Prüfzeichen**
- Laufzeit: bis zu 9,5 Stunden
- inkl. Batterien (2x AAA)
- mit Batteriezustandsanzeige
- in M-Wave Blisterverpackung

- 1 red **high power SMD LED**
- universal bracket suitable for Ø 25.4 - 31.8 mm (art. 223516)
- with **German approval number**
- running time: up to 9.5 hours
- incl. batteries (2x AAA)
- with battery level indicator
- in M-Wave blister packaging



30 g



BATTERIERÜCKLICHT

›HELIOS K 1.1 RS‹

BATTERY REAR LIGHT

›HELIOS K 1.1 RS‹

- innovatives Design
- mit **deutschem Prüfzeichen**
- nur **30 g**
- **230° sichtbar** durch transparentes Gehäuse
- universeller Gummihalter Ø 22,2 - 30 mm
- **werkzeuglose** Montage an der **Sattelstütze, Sitzrohr- oder Kettenstrebe** möglich
- inkl. Batterien (2x CR 2032)

- innovative design
- with **German approval number**
- only **30 g**
- **230° visible** because of transparent housing
- universal rubber bracket Ø 22.2 - 30 mm
- **toolless** mounting at the **seat post, seat tube or chain stay** possible
- incl. batteries (2x CR 2032)



221055 auf M-Wave Eurolochkarte

on M-Wave eurohole card

221054 Montageverpackung

OEM

4,90 €

221040 BATTERIEBLINKLICHT

›ATLAS L.R‹

BATTERY FLASHING LIGHT

›ATLAS L.R‹











3,90 €

- **3 rote LEDs**
- 3 Funktionen (1x Dauer- und 2x Blinklicht)
- mit Halter (Art. 220824) für Sattelstütze und Gürtelclip
- inkl. **Batterien** (2x AAA)
- in M-Wave Blisterverpackung

- **3 red LEDs**
- 3 functions (1x steady and 2x flashing light)
- with bracket (art. 220824) for seat post and belt clip
- incl. **batteries** (2x AAA)
- in M-Wave blister packaging



Ohne deutsches Prüfzeichen - Verkauf und Nutzung im Geltungsbereich der StVZO (Deutschland) unzulässig (Abgabe nur an außerdeutsche Kunden).

ART.-NR. UVP	BESCHREIBUNG	DESCRIPTION	
221034 3,90 € 	BATTERIEBLINKLICHT ›HELIOS 5.3‹ <ul style="list-style-type: none"> • 5 ultrahelle SMD-LEDs • 3 Funktionen (1x Dauer- und 2x Blinklicht) • mit winkelverstellbarem Clip-on Gummibandhalter passend für Ø 25,4 - 31,8 mm • Licht 90° drehbar • inkl. Batterien (2x AAA) • in M-Wave Blisterverpackung <p>Ohne deutsches Prüfzeichen - Verkauf und Nutzung im Geltungsbereich der StVZO (Deutschland) unzulässig (Abgabe nur an außerdeutsche Kunden).</p>	BATTERY FLASHING LIGHT ›HELIOS 5.3‹ <ul style="list-style-type: none"> • 5 superbright SMD LEDs • 3 functions (1x steady and 2x flashing light) • with angle-adjustable clip-on rubber bracket suitable for Ø 25.4 - 31.8 mm • light 90° turnable • incl. batteries (2x AAA) • in M-Wave blister packaging 	
220627 8,90 €   	AKKU-BLINKLICHT ›APOLLON MINI A USB‹ <ul style="list-style-type: none"> • hochwertiges Aluminiumgehäuse • 1 rote 0,5 Watt LED • 10 Lumen • aufladbar über USB-Kabel (inkl.) • Lithium-Akku (3,7 V / 220 mAh) • mit Batteriezustands- und Ladezustandsanzeige • bis zu 30 Stunden Laufzeit • 3 Funktionen (1x Dauer- und 2x Blinklicht) • nur 26 g • universelle, werkzeuglose Montage durch elastisches Gummiband Ø 22,2 - 31,8 mm • in M-Wave Blisterverpackung 	RECHARGEABLE FLASHING LIGHT ›APOLLON MINI A USB‹ <ul style="list-style-type: none"> • high quality aluminium housing • 1 red 0.5 Watt LED • 10 Lumen • rechargeable by USB cable (incl.) • rechargeable Lithium battery (3.7 V / 220 mAh) • with battery level and charge control indicator • up to 30 hours run time • 3 functions (1x steady and 2x flashing light) • only 26 g • universal, toolless mounting with elastic rubber strap Ø 22.2 - 31.8 mm • in M-Wave blister packaging 	
220628 19,90 € / set	wie Art. 220627, Set für vorne und hinten	like art. 220627, set for front and rear	<p>Ohne deutsches Prüfzeichen - Verkauf und Nutzung im Geltungsbereich der StVZO (Deutschland) unzulässig (Abgabe nur an außerdeutsche Kunden).</p>
220565 8,90 € / set  	BATTERIEBLINKLICHT-SET ›APOLLON MINI A‹ <ul style="list-style-type: none"> • hochwertiges Aluminiumgehäuse • Set mit einer weißen und einer roten LED • 240° Abstrahlwinkel • 3 Funktionen (1x Dauer- und 2x Blinklicht) • nur 25 g/Stück • universelle, werkzeuglose Montage durch elastische Gummibänder Ø 22,2 - 31,8 mm • inkl. Batterien (je 2x CR 2032) • in M-Wave Blisterverpackung <p>Ohne deutsches Prüfzeichen - Verkauf und Nutzung im Geltungsbereich der StVZO (Deutschland) unzulässig (Abgabe nur an außerdeutsche Kunden).</p>	BATTERY FLASHING LIGHT SET ›APOLLON MINI A‹ <ul style="list-style-type: none"> • high quality aluminium housing • set with one white and one red LED • 240° radiation angle • 3 functions (1x steady and 2x flashing light) • only 25 g/piece • universal, toolless mounting with elastic rubber straps Ø 22.2 - 31.8 mm • incl. batteries (2x CR 2032 each) • in M-Wave blister packaging 	
220608 7,90 € / set 	BATTERIEBLINKLICHT-SET ›HUNTER‹ <ul style="list-style-type: none"> • innovatives Design • Set mit je 2 weißen bzw. 2 roten LEDs • 3 Funktionen (1x Dauer- und 2x Blinklicht) • universelle Befestigung durch elastische Silikonbänder • werkzeuglose Montage • inkl. Batterien (je 2x CR 2032) • in M-Wave Blisterverpackung <p>Ohne deutsches Prüfzeichen - Verkauf und Nutzung im Geltungsbereich der StVZO (Deutschland) unzulässig (Abgabe nur an außerdeutsche Kunden).</p>	BATTERY FLASHING LIGHT SET ›HUNTER‹ <ul style="list-style-type: none"> • innovative design • set with 2 white and 2 red LEDs • 3 functions (1x steady and 2x flashing light) • universal fixation with elastic silicone straps • toolless mounting • incl. batteries (each 2x CR 2032) • in M-Wave blister packaging 	

ART.-NR. BESCHREIBUNG
UVP

DESCRIPTION



BATTERIEBLINKLICHT
›COBRA‹

- innovatives Design
- 2 Funktionen (Dauer- und Blinklicht)
- nur **18 g**
- universeller Gummihalter
- **werkzeuglose** Schnellmontage
- inkl. Schraubendreher für Batterie-wechsel
- inkl. Batterien (2x CR 2025)
- farbig sortiert
- in M-Wave Blisterverpackung



BATTERY FLASHING LIGHT
›COBRA‹

- innovative design
- 2 functions (steady and flashing light)
- only **18 g**
- universal rubber bracket
- **toolless** quick mounting
- incl. screw driver for changing batteries
- incl. batteries (2x CR 2025)
- assorted colours
- in M-Wave blister packaging



220582 weiße LED

white LED

220583 rote LED

red LED

4,90 €



220584 BATTERIEBLINKLICHT-SET
›COBRA‹

7,90 € / set

- Set mit je einer **weißen** (Art. 220582) und **roten** (Art. 220583) **LED**
- farbig sortiert
- in M-Wave Blisterverpackung

BATTERY FLASHING LIGHT SET
›COBRA‹

- set with one **white** (art. 220582) and one **red** (art. 220583) **LED**
- assorted colours
- in M-Wave blister packaging



Ohne deutsches Prüfzeichen - Verkauf und Nutzung im Geltungsbereich der StVZO (Deutschland) unzulässig (Abgabe nur an außerdeutsche Kunden).

220599 BATTERIEBLINKLICHT-SET
›COBRA II‹

6,90 € / set



- Set mit je **2 weißen** bzw. **2 roten LEDs**
- 3 Funktionen (1x Dauer- und 2x Blinklicht)
- nur 24 g
- universelle Befestigung durch elastische Silikonbänder
- werkzeuglose Montage
- inkl. Batterien (je 2x CR 2032)
- in M-Wave Blisterverpackung

BATTERY FLASHING LIGHT SET
›COBRA II‹

- set with **2 white** and **2 red LEDs**
- 3 functions (1x steady and 2x flashing light)
- only 24 g
- universal fixation with elastic silicone straps
- toolless mounting
- incl. batteries (each 2x CR 2032)
- in M-Wave blister packaging



Ohne deutsches Prüfzeichen - Verkauf und Nutzung im Geltungsbereich der StVZO (Deutschland) unzulässig (Abgabe nur an außerdeutsche Kunden).

221063 BATTERIEBLINKLICHT-SET
›COBRA III‹

5,90 € / set



- Set mit je **2 weißen** bzw. **2 roten LEDs**
- 2 Funktionen (Dauer- und Blinklicht)
- nur **19 g**
- universeller Gummihalter Ø 22,2 - 31,8 mm
- werkzeuglose Montage
- inkl. Batterien (je 2x CR 2032)
- in M-Wave Blisterverpackung

BATTERY FLASHING LIGHT SET
›COBRA III‹

- set with **2 white** and **2 red LEDs**
- 2 functions (steady and flashing light)
- only **19 g**
- universal rubber bracket Ø 22.2 - 31.8 mm
- toolless mounting
- incl. batteries (each 2x CR 2032)
- in M-Wave blister packaging



Ohne deutsches Prüfzeichen - Verkauf und Nutzung im Geltungsbereich der StVZO (Deutschland) unzulässig (Abgabe nur an außerdeutsche Kunden).

ART.-NR. UVP
BESCHREIBUNG

DESCRIPTION



**BATTERIEBLINKLICHT-SET
›COBRA IV‹**

**BATTERY FLASHING LIGHT SET
›COBRA IV‹**



- Set mit je **2 weißen** und **2 roten LEDs**
- 3 Funktionen (1x Dauer- und 2x Blinklicht)
- nur 24 g pro Licht
- universeller Silikonhalter
- werkzeuglose Montage
- inkl. Batterien (je 2x CR 2032)
- in M-Wave Blisterverpackung

- set with **2 white** and **2 red LEDs**
- 3 functions (1x steady and 2x flashing light)
- only 24 g per lamp
- universal silicone bracket
- toolless mounting
- incl. batteries (each 2x CR 2032)
- in M-Wave blister packaging



- 220630** schwarz
- 220632** weiß
- 220633** rot
- 220634** blau
- 220635** grün
- 220636** gelb
- 220637** orange
- 220638** pink
- 220639** lila

- black
- white
- red
- blue
- green
- yellow
- orange
- pink
- purple



Lamps & Brackets

6,90 € Ohne deutsches Prüfzeichen - Verkauf und Nutzung im Geltungsbereich der StVZO (Deutschland) unzulässig (Abgabe nur an außerdeutsche Kunden).

**221058 AKKULAMPEN-SET
›ATLAS K10 USB‹**

49,90 € / set



- mit **deutschem Prüfzeichen**
- **wasserfestes Silikongehäuse**
- integrierter **universeller Silikonhalter**
- **schnelle** werkzeuglose Montage
- mit Batterie- und Ladezustandsanzeige
- aufladbar über **USB-Kabel** (inkl.)
- in M-Wave Eurolochkarte

**RECHARGEABLE LAMP SET
›ATLAS K10 USB‹**

- with **German approval number**
- **water resistant silicone housing**
- integrated **universal silicone bracket**
- **quick** toolless mounting
- with battery level and charge control indicator
- rechargeable by **USB cable** (incl.)
- in M-Wave eurohole card



Frontlicht (Art. 220405):

- 1 weiße **Cree LED**
- Helligkeit **25 Lux**
- nur ca. 86 g
- Lithium-Polymer Schnellladeakku
- Halter für Ø 22,2 - 32 mm

front light (art. 220405):

- 1 white **Cree LED**
- brightness **25 Lux**
- only approx. 86 g
- Lithium Polymer quick charge battery
- bracket for Ø 22.2 - 32 mm



Rücklicht (Art. 220572):

- 1 rote **Hochleistungs-LED**
- **Lithium-Akku**

rear light (art. 220572):

- 1 red **high power LED**
- **Lithium rechargeable battery**



**221090 AKKULAMPEN-SET
›ATLAS K 11 USB‹**

19,90 € / set



- mit **deutschem Prüfzeichen**
- schnelle werkzeuglose Montage
- mit **Batterie- und Ladezustandsanzeige**
- aufladbar über **USB-Kabel** (inkl.)
- **Lithium-Akku**
- in M-Wave Blisterverpackung

**RECHARGEABLE LAMP SET
›ATLAS K 11 USB‹**

- with **German approval number**
- quick toolless mounting
- with **battery level and charge control indicator**
- rechargeable by **USB cable** (incl.)
- **rechargeable Lithium battery**
- in M-Wave blister packaging



Frontlicht:

- 1 weiße **Osram LED**
- **2 Funktionen** (2x Dauerlicht)
- Helligkeit **28 / 15 Lux**
- bis zu **70 Lumen**
- Halter für Ø 22,2 - 31,8 mm (Art. 223553)
- nur ca. **55 g**

front light:

- 1 white **Osram LED**
- **2 functions** (2x steady light)
- brightness **28 / 15 Lux**
- up to **70 Lumen**
- bracket for Ø 22.2 - 31.8 mm (art. 223553)
- only approx. **55 g**



Rücklicht:

- 3 rote **LEDs**
- nur ca. **23 g**
- Halter für Ø 25,4 - 33 mm (Art. 223554)

rear light:

- 3 red **LEDs**
- only approx. **23 g**
- bracket for Ø 25.4 - 33 mm (art. 223554)



ART.-NR. BESCHREIBUNG
UVP

DESCRIPTION

221091 AKKULAMPEN-SET
›ATLAS K 15 USB‹

29,90 € /set



- mit **deutschem Prüfzeichen**
- schnelle werkzeuglose Montage
- mit Batterie- und Ladezustandsanzeige
- aufladbar über **USB-Kabel** (inkl.)
- in M-Wave Blisterverpackung

Frontlicht Art. 220404:

- 1 weiße **LED**
- 2 Funktionen (maximale Beleuchtung, Energiesparmodus)
- Helligkeit **30 / 15 Lux**
- 360° drehbarer Halter für Ø 19 - 31,8 mm (Art. 223559)
- nur ca. 51 g
- **Lithium-Akku** (3,7 V / 1.200 mAh)

Rücklicht Art. 220559:

- 1 rote **LED**
- Halter für Ø 19 - 31,8 mm (Art. 223561)
- **240 Grad** Abstrahlwinkel
- **Lithium-Polymer Akku**

RECHARGEABLE LAMP SET
›ATLAS K 15 USB‹

- with **German approval number**
- quick toolless mounting
- with battery level and charge control indicator
- rechargeable by **USB cable** (incl.)
- in M-Wave blister packaging

front light art. 220404:

- 1 white **LED**
- 2 functions (maximum illumination, power saving mode)
- brightness **30 / 15 Lux**
- 360° turnable bracket for Ø 19 - 31.8 mm (Art. 223559)
- only approx. 51 g
- **rechargeable Lithium battery** (3.7 V / 1,200 mAh)

rear light art. 220559:

- 1 red **LED**
- bracket for Ø 19 - 31.8 mm (Art. 223561)
- **240 degrees** illumination angle
- **rechargeable Lithium Polymer battery**



221092 AKKULAMPEN-SET
›ATLAS 20 USB‹

27,90 € / set



- mit Batterie- und Ladezustandsanzeige
- aufladbar über **USB-Kabel** (inkl.)
- Lithium-Akku
- auf M-Wave Eurolochkarte

Frontlicht Art. 220421:

- 1 weiße **1 Watt LED** mit SST (**Soft Start Technology**)
- hochwertiges **Aluminiumgehäuse**
- **3 Funktionen:** 2x Dauer- und 1x Blinklicht
- Helligkeit bis zu 20 Lux, 95 Lumen
- Halter für Ø 22,2 - 35 mm (Art. 223551)
- nur ca. **54 g**

Rücklicht:

- 1x **0,5 Watt LED** mit rotem Glas
- 3 Funktionen: 2x Dauer- und 1x Blinklicht
- schnelle werkzeuglose Montage
- winkelverstellbarer Halter für Ø 25,4 - 35 mm
- nur ca. **17 g**

RECHARGEABLE LAMP SET
›ATLAS 20 USB‹

- with battery level and charge control indicator
- rechargeable by **USB cable** (incl.)
- rechargeable Lithium battery
- on M-Wave eurohole card

front light art. 220421:

- 1 white **1 Watt LED** with SST (**Soft Start Technology**)
- high quality **aluminium** housing
- **3 functions:** 2x steady and 1x flashing light
- brightness levels up to 20 Lux, 95 Lumen
- bracket for Ø 22.2 - 35 mm (art. 223551)
- only approx. **54 g**

rear light:

- 1x **0.5 Watt LED** with red glas
- 3 functions: 2x steady and 1x flashing light
- quick toolless mounting
- angle-adjustable bracket for Ø 25.4 - 35 mm
- only approx. **17 g**



Ohne deutsches Prüfzeichen - Verkauf und Nutzung im Geltungsbereich der StVZO (Deutschland) unzulässig (Abgabe nur an außerdeutsche Kunden).

221064 BATTERIELEUCHTEN-SET
›ATLAS 22‹

15,90 € / set



- inkl. Batterien (6x AAA)
- in M-Wave Eurolochkarte

Frontlicht (Art. 220887):

- **Aluminiumgehäuse**
- weiße, **ultrahelle 3 Watt LED**
- 2 Funktionen: Dauer- und Blinklicht
- mit Dreh-Clip-on-Halter für Ø 22,2 - 31,8 mm (Art. 223541), werkzeuglose Montage

Blinklicht (Art. 221040):

- 3 rote LEDs
- 3 Funktionen: 1x Dauer- und 2x Blinklicht
- mit Halter (Art. 220824) für Sattelstütze und Gürtelclip

BATTERY LAMP SET
›ATLAS 22‹

- incl. batteries (6x AAA)
- in M-Wave eurohole card

front light (art. 220887):

- **aluminium** housing
- white, **ultra bright 3 Watt LED**
- 2 functions: steady and flashing light
- with twist clip-on bracket for Ø 22.2 - 31.8 mm (art. 223541), toolless mounting

flashing light (art. 221040):

- 3 red LEDs
- 3 functions: 1x steady and 2x flashing light
- with bracket (art. 220824) for seat post and belt clip



Ohne deutsches Prüfzeichen - Verkauf und Nutzung im Geltungsbereich der StVZO (Deutschland) unzulässig (Abgabe nur an außerdeutsche Kunden).

ART.-NR. BESCHREIBUNG
UVP

DESCRIPTION

221057 BATTERIELEUCHTEN-SET

16,90 € / set



- mit **deutschem Prüfzeichen**
- mit Batteriezustandsanzeige
- inkl. Batterien (4x AAA / 2x AAA)
- in M-Wave Blisterverpackung



- Frontlicht** (Art. 220447):
- 1 weiße **Hochleistungs-LED**
 - **Klarglasscheinwerfer** mit **Freiformreflektor**
 - 2 Helligkeitsstufen: **30/15 Lux**
 - nur **49 g** (ohne Batterien)
 - mit QR-Clip-on-Halter für **Ø 22,2 - 31,8 mm** (Art. 223515), werkzeuglose Montage

- Rücklicht** (Art. 220569):
- 1 rote **Hochleistungs-SMD-LED**
 - Universalhalter passend für **Ø 25,4 - 31,8 mm** (Art. 223516)

BATTERY LAMP SET

›ATLAS K50‹

- with **German approval number**
- with battery level indicator
- incl. batteries (4x AAA / 2x AAA)
- in M-Wave blister packaging

- front light** (art. 220447):
- 1 white **high power/performance LED**
 - **clear lens beam** with **special reflector**
 - 2 brightness levels: **30/15 Lux**
 - only **49 g** (w/o batteries)
 - with QR clip-on bracket for **Ø 22.2 - 31.8 mm** (art. 223515), toolless mounting

- rear light** (art. 220569):
- 1 red **high power SMD LED**
 - universal bracket for **Ø 25.4 - 31.8 mm** (art. 223516)



Lamps & Brackets

220423 STIRNLAMPE
›HELIOS RUNNER 140‹

18,90 €



- **Cree XP-G2 R5 LED, 5 Watt**
- leichtes, wasserdichtes (IPX5) Kunststoffgehäuse
- 4 Funktionen: 3x Helligkeitsstufen und zusätzliche **SOS-Funktion**
- **Sensorfunktion:** an/aus über Handbewegung zu steuern
- justierbarer und flexibler Kopfgurt mit **Anti-Rutsch-Silikon-Beschichtung**
- Helligkeit bis zu 140 Lumen
- Abstrahlwinkel bis zu 60° einstellbar
- Lithium-Polymer Akku, 1.200 mAh
- Laufzeit: bis zu 15 Stunden
- inkl. Micro **USB-Kabel**
- mit Batterie- und Ladezustandsanzeige
- nur 52 g (ohne Kopfgurt)
- in M-Wave Eurolochbox

HEAD LIGHT
›HELIOS RUNNER 140‹

- **Cree XP-G2 R5 LED, 5 Watt**
- light and waterproof (IPX5) plastic housing
- 4 functions: 3x brightness levels and additional **SOS function**
- **sensor function:** control on/off by hand movement
- adjustable and flexible head belt with **non-slip silicone coating**
- brightness up to 140 Lumen
- adjustable beam angle up to 60°
- rechargeable lithium polymer battery, 1,200 mAh
- running time: up to 15 hours
- incl. Micro **USB** cable
- with battery level and charge control indicator
- only 52 g (without head strap)
- in M-Wave eurohole box

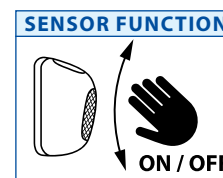

Ohne deutsches Prüfzeichen - Verkauf und Nutzung im Geltungsbereich der StVZO (Deutschland) unzulässig (Abgabe nur an außerdeutsche Kunden).



223570 KONVERTER **›POWER BASE‹**

5,90 €



- von Wechselstrom- auf **USB-Anschluss**
- **Eingangsleistung:** 100-240 V Wechselstrom, 0,15 A, 50/60 Hz
- **Ausgangsleistung:** 5 V Gleichstrom, max. 1 A
- Schutzklasse II, IP 20
- mit **Lade-Kontrollleuchte**
- auf M-Wave Eurolochkarte

CONVERTER **›POWER BASE‹**

- AC to **USB**
- **Input:** AC 100-240 V, 0.15 A, 50/60 Hz
- **Output:** DC 5 V, max. 1 A
- protection class II, IP 20
- with **battery indicator light**
- on M-Wave eurohole card



ART.-NR. BESCHREIBUNG
UVP

DESCRIPTION

220753 LENKERCOCKPIT
›COCKPIT PLUS‹

9,90 €

- passend für Lenker mit **Ø 22,2 - 31,8 mm**
- Rohrdurchmesser 22,2 mm
- Breite 90 mm
- **verschiebbar**
- auf M-Wave Eurolochkarte

HANDLEBAR ORGANIZER
›COCKPIT PLUS‹

- for handlebar with **Ø 22.2 - 31.8 mm**
- tube diameter 22.2 mm
- width 90 mm
- **slidable**
- on M-Wave eurohole card



220972 GABELHALTER
›FORK COCKPIT‹

4,90 €

- passend für **Gabelbrücke** und **Gabelkopf**
- runde Aufnahme mit Ø 22,2 mm
- **ausziehbar**
- universell geeignet für fast alle Batterielampen, Computer, ...
- auf M-Wave Eurolochkarte

FORK BRACKET
›FORK COCKPIT‹

- suitable for **fork arch** and **crown**
- round fixing point with Ø 22.2 mm
- **extendable**
- universally suitable for almost all battery lamps, computers, ...
- on M-Wave eurohole card



223560 SCHNELLSPANNER-
LAMPENHALTER ›AXLE MOUNT‹

8,90 €

- zur Befestigung **am Schnellspanner** (5 mm, nicht inklusive)
- **CNC-gefrästes Aluminium**
- Länge: 57 mm, Ø 26 mm
- Gewicht: 19 g
- auf M-Wave Eurolochkarte

QUICK RELEASE
LAMP HOLDER ›AXLE MOUNT‹

- for mounting **at QR** (5 mm, not included)
- **CNC machined aluminium**
- length: 57 mm, Ø 26 mm
- weight: 19 g
- on M-Wave eurohole card



M-WAVE

YOUR WORLD OF CYCLING

ART.-NR. BESCHREIBUNG
UVP

DESCRIPTION

E-BIKE

E-BIKE



466142 E-BIKE-SCHEINWERFER
›APOLLON E 100‹
34,90 €

- **100 Lux**
- 6 - 48 V DC/1,4 W
- hochwertiges **Aluminium-/Kunststoff-**gehäuse
- mit **deutschem Prüfzeichen**
- **abnehmbarer Reflektor**
- mit **2-fach verstellbarem Halter**
- mit Doppelkabel, 10 cm, mit Flachstecker
- auf M-Wave Eurolochkarte



E-BIKE HEAD LAMP
›APOLLON E 100‹

- **100 Lux**
- 6 - 48 V DC/1.4 W
- high quality **aluminium/plastic** housing
- with **German approval number**
- **removable** reflector
- with **double adjustable bracket**
- with double cable, 10 cm, with flat plug
- on M-Wave eurohole card



466141 E-BIKE-SCHEINWERFER
›APOLLON E 80‹
21,902 €

- **80 Lux**
- 6 - 48 V DC/2,4 W
- mit **deutschem Prüfzeichen**
- **abnehmbarer Reflektor**
- mit **2-fach verstellbarem Halter**
- mit Doppelkabel, 10 cm, mit Flachstecker
- auf M-Wave Eurolochkarte



E-BIKE HEAD LAMP
›APOLLON E 80‹

- **80 Lux**
- 6 - 48 V DC/2.4 W
- with **German approval number**
- **removable** reflector
- with **double adjustable bracket**
- with double cable, 10 cm, with flat plug
- on M-Wave eurohole card



466143 E-BIKE-SCHEINWERFER
›APOLLON E 30‹
11,90 €

- **30 Lux**
- 6 - 48 V DC/1,3 W
- mit **deutschem Prüfzeichen**
- Reflektor mit deutschem Prüfzeichen
- mit **Edelstahthalter**
- mit Doppelkabel, 10 cm, mit Flachstecker
- Montageverpackung



E-BIKE HEAD LAMP
›APOLLON E 30‹

- **30 Lux**
- 6 - 48 V DC/1.3 W
- with **German approval number**
- reflector with German approval number
- with **stainless steel bracket**
- with double cable, 10 cm, with flat plug
- OEM



DYNAMO

DYNAMO



LED-DYNAMOSCHEINWERFER
›APOLLON D 50‹

- **50 Lux**
- 6 V/2,2 W
- mit **Ein-/Ausschalter**
- mit **Standlichtfunktion**
- mit **deutschem Prüfzeichen**
- **abnehmbarer Reflektor**
- mit **Edelstahthalter**
- mit Doppelkabel

LED DYNAMO HEAD LAMP
›APOLLON D 50‹

- **50 Lux**
- 6 V/2.2 W
- with **on/off switch**
- with **standlight function**
- with **German approval number**
- **removable** reflector
- with **stainless steel bracket**
- with double cable

461606 Montageverpackung

OEM

461607 auf M-Wave Eurolochkarte
13,90 €

on M-Wave eurohole card



ART.-NR. UVP **BESCHREIBUNG**

DESCRIPTION



LED-DYNAMOSCHEINWERFER ›APOLLON D 30‹

- **30 Lux**
- 6 V/2,4 W
- mit **Ein-/Ausschalter** (für Vorder- und Rücklicht)
- mit **Standlichtfunktion**
- mit **deutschem Prüfzeichen**
- **abnehmbarer** Reflektor
- mit Edelstahlhalter
- mit 2 Doppelkabeln, 100 cm
- 2 im Gehäuse integrierte Flachsteckanschlüsse



LED DYNAMO HEAD LAMP ›APOLLON D 30‹

- **30 Lux**
- 6 V/2.4 W
- with **on/off switch** (for front and rear light)
- with **standlight function**
- with **German approval number**
- **removable** reflector
- with stainless steel bracket
- with 2 double cables, 100 cm
- 2 flat plugs integrated in the housing



466944 Montageverpackung

OEM

466945 auf M-Wave Eurolochkarte

on M-Wave eurohole card

12,90 €

E-BIKE

E-BIKE 

466151 E-BIKE-GEPÄCKTRÄGER-RÜCKLICHT ›HELIOS E BRAKE‹

14,90 €



- 6 - 48 V DC/0,6 W
- **2 superhelle, rote LEDs an den Seiten**
- **COB LED** (21 Chips)
- mit **deutschem Prüfzeichen**
- mit **Bremslichtfunktion**
- integrierter Z-Reflektor
- für Lochabstand 80 mm
- 2 im Gehäuse integrierte Flachsteckanschlüsse
- auf M-Wave Eurolochkarte



E-BIKE CARRIER REAR LIGHT ›HELIOS E BRAKE‹

- 6 - 48 V DC/0.6 W
- **2 super bright, red LEDs at the sides**
- **COB LED** (21 chips)
- with **German approval number**
- with **brake light function**
- integrated Z-reflector
- for hole distance 80 mm
- 2 flat plugs integrated in the housing
- on M-Wave eurohole card



466150 E-BIKE-GEPÄCKTRÄGER-RÜCKLICHT ›HELIOS E‹

11,90 €



- 6 - 48 V DC/0,6 W
- 3 superhelle, rote **LEDs**
- mit **deutschem Prüfzeichen**
- integrierter Z-Reflektor
- für Lochabstand 80 mm
- 2 im Gehäuse integrierte Flachsteckanschlüsse
- Montageverpackung

E-BIKE CARRIER REAR LIGHT ›HELIOS E‹

- 6 - 48 V DC/0.6 W
- 3 super bright, red **LEDs**
- with **German approval number**
- integrated Z-reflector
- for hole distance 80 mm
- 2 flat plugs integrated in the housing
- OEM



DYNAMO

DYNAMO

466905 DYNAMO-GEPÄCKTRÄGER-RÜCKLICHT ›HELIOS D‹

11,90 €



- 1 **superhelle, rote LED**
- 6 V/0,5 W
- mit **Standlichtfunktion**
- mit **deutschem Prüfzeichen**
- integrierter Z-Reflektor
- Stecker für **Doppelanschluss** (+ und -)
- für Lochabstand **50 und 80 mm**
- inkl. Befestigungsschrauben und Muttern
- Montageverpackung



DYNAMO CARRIER REAR LIGHT ›HELIOS D‹

- 1 **super bright, red LED**
- 6 V/0.5 W
- with **standlight function**
- with **German approval number**
- integrated Z-reflector
- plug for **double connection** (+ and -)
- for hole distance **50 and 80 mm**
- incl. fastening screws und nuts
- OEM



ART.-NR. UVP **BESCHREIBUNG** **DESCRIPTION**

466950
11,90 €

AKKU-GEPÄCKTRÄGER-RÜCKLICHT ›HELIOS USB‹



- 1 **superhelle, rote LED**
- 3,7 V/300 mAh
- mit **Lithium-Polymer Akku**
- mit **deutschem Prüfzeichen**
- integrierter Z-Reflektor
- mit **Ladezustandsanzeige**
- für Lochabstand 50 und 80 mm
- **2 in 1:** Gummihalter (Art. 223561) für Sattelstützmontage und Befestigungsschrauben für Gepäckträgermontage
- **inkl. USB-Kabel**
- auf M-Wave Eurolochkarte

RECHARGEABLE CARRIER REAR LIGHT ›HELIOS USB‹

- 1 **super bright, red LED**
- 3.7 V/300 mAh
- with **lithium polymer rechargeable battery**
- with **German approval number**
- integrated Z-reflector
- with **charge control indicator**
- for hole distance 50 and 80 mm
- **2 in 1:** rubber bracket (art. 223561) for seat post mounting and fastening screws for carrier mounting
- **incl. USB cable**
- on M-Wave eurohole card



BATTERIE-GEPÄCKTRÄGER-RÜCKLICHT ›HELIOS B‹

- 2 **superhelle, rote LEDs**
- mit **deutschem Prüfzeichen**
- integrierter Z-Reflektor
- mit **Batteriezustandsanzeige**
- inkl. Batterien (2x AAA)
- für Lochabstand 50 und 80 mm
- inkl. Befestigungsschrauben und Muttern

BATTERY CARRIER REAR LIGHT ›HELIOS B‹

- 2 **super bright, red LEDs**
- with **German approval number**
- integrated Z-reflector
- with **battery level indicator**
- incl. Batteries (2x AAA)
- for hole distance 50 and 80 mm
- incl. fastening screws und nuts

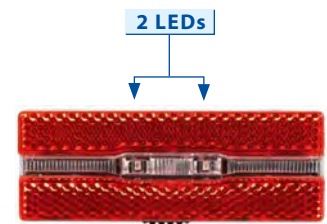

466925

Montageverpackung

OEM

466926

auf M-Wave Eurolochkarte

on M-Wave eurohole card

8,90 €

466670

3M™ SCOTCHLITE SPEICHENREFLEKTOR

9,90 €



- **3M Scotchlite®** Reflexmaterial
- **360° Sichtbarkeit**
- Länge: 70 mm
- einfache Montage ohne Werkzeug
- mit **deutschem Prüfzeichen** (gültig bei Anbringung an 36 Speichen in einem Laufrad)

3M™ SCOTCHLITE SPOKE REFLECTOR

- **3M Scotchlite®** reflective material
- **360° visibility**
- length: 70 mm
- easy mounting without tools
- with **German approval number** (only applies when mounted on 36 spokes in one wheel)



466670

1 Set = 18 Stück
in M-Wave Blisterverpackung

9,90 € / set

1 set = 18 pcs
in M-Wave blister packaging

466671

Montageverpackung

OEM

0,59 €



ART.-NR. BESCHREIBUNG
UVP

DESCRIPTION

HIGH SECURITY

HIGH SECURITY

HIGH SECURITY

**SEIEN SIE SICH SICHER,
BEI DIESER SICHERHEIT!**

Unsere **hochwertigen Schlösser** punkten sowohl mit **extra** starken und gehärteten Stahlkernen, als auch mit **top verarbeiteten Schließköpfen**. Hier schreckt nicht nur die Optik jeden Dieb ab!

BE SURE, WITH THIS SAFETY!

Our **high-class locks** score with **extra** strong and hardened steel cores as well as **highly processed lock heads**. Not only the visual appearance will frighten off every potential thief!



230950 KETTENSCHLOSS ›C 10.9-360‹

49,90 €

10 x 10 x 900



- 10 x 10 x 900 mm
- **besonders widerstandsfähig** durch **gehärtete quadratische Kettenglieder** und **robusten Schließzylinder**
- viele verschiedene **computer-designte** Schlüsselvarianten
- **360° drehbarer Verschlusskopf**
- mit Staubschutzkappe
- mit Textilüberzug
- mit M-Wave Banderole

CHAIN LOCK ›C 10.9-360‹

- 10 x 10 x 900 mm
- **very robust** because of **hardened square chain links** and **robust cylinder lock**
- many different **computer-designed** key variants
- **360° turnable lock head**
- with dust cap
- with textile cover
- with M-Wave banderole



230920 SPIRALKABELSCHLOSS ›S 20.18‹

30,90 €

20 x 1.800

- Ø 20 x 1.800 mm
- **extra dickes**, geflochtenes Kabel
- **360° drehbarer Verschlusskopf**
- dunkel-transparenter Überzug
- viele verschiedene **computer-designte** Schlüsselvarianten
- universeller Clip-on-Halter für Sattelstütze und Rahmenrohr Ø 22,2 - 43 mm
- mit Staubschutzkappe
- auf M-Wave Eurolochkarte

SPIRAL CABLE LOCK ›S 20.18‹

- Ø 20 x 1,800 mm
- **extra thick**, braided cable
- **360° turnable lock head**
- dark transparent cover
- many different **computer-designed** key variants
- universal clip-on bracket for seat post and frame tube Ø 22.2 - 43 mm
- with dust cap
- on M-Wave eurohole card



230910 SPIRALKABELSCHLOSS ›DS 20.18‹

34,90 €

20 x 1.800



- Ø 20 x 1.800 mm
- **extra dickes**, geflochtenes Kabel
- dunkel-transparenter Überzug
- **verstellbarer, persönlicher Sicherheitscode** aus **5 Zahlen**
- auf M-Wave Eurolochkarte

SPIRAL CABLE LOCK ›DS 20.18‹

- Ø 20 x 1,800 mm
- **extra thick**, braided cable
- dark transparent cover
- **changeable, individual security code** with **5 digits**
- on M-Wave eurohole card



REFLEX



REFLEX



REFLEX

230961 SPIRALKABELSCHLOSS ›S 10.18 ILLU‹

8,90 €



10 x 1.800

- Ø 10 x 1.800 mm
- mit **Reflexstreifen**
- dunkel-transparenter Überzug
- Clip-on-Halter (Art. 233849) für Sattelstütze und Rahmenrohr, beidseitig einführbar
- mit **Staubschutzkappe**
- **automatische Verriegelung**
- auf M-Wave Eurolochkarte

SPIRAL CABLE LOCK ›S 10.18 ILLU‹

- Ø 10 x 1,800 mm
- with **reflective stripe**
- dark transparent cover
- clip-on bracket (art. 233849) for seat post and frame tube, clip-on possibility from both sides
- with **dust cap**
- **automatic locking**
- on M-Wave eurohole card



ART.-NR. BESCHREIBUNG
UVP

DESCRIPTION

REFLEX



REFLEX



REFLEX

230962 SPIRALKABELSCHLOSS

›DS 10.18 ILLU‹

8,90 €



10 x
1.800

- Ø 10 x 1.800 mm
- mit **Reflexstreifen**
- dunkel-transparenter Überzug
- **verstellbarer**, persönlicher Sicherheitscode
- Clip-on-Halter (Art. 233849) für Sattelstütze oder Rahmenrohr, beidseitig einführbar
- auf M-Wave Eurolochkarte

SPIRAL CABLE LOCK

›DS 10.18 ILLU‹

- Ø 10 x 1.800 mm
- with **reflective stripe**
- dark transparent cover
- **changeable**, individual security code
- clip-on bracket (art. 233849) for seat post or frame tube, clip-on possibility from both sides
- on M-Wave eurohole card



230960 KABELSCHLOSS ›C 15.8 ILLU‹

7,90 €



15 x
1.800

- Ø 15 x 800 mm
- geflochtenes Kabel
- mit **Reflexstreifen**
- dunkel-transparenter Überzug
- **automatische Verriegelung**
- auf M-Wave Eurolochkarte

CABLE LOCK ›C 15.8 ILLU‹

- Ø 15 x 800 mm
- braided cable
- with **reflective stripe**
- dark transparent cover
- **automatic locking**
- on M-Wave eurohole card



230963 KETTENSCHLOSS ›C 6.8,5 ILLU‹

14,90 €



6 x
850

- Ø 6 x 850 mm
- Textilüberzug mit **Reflexstreifen**
- **automatische Verriegelung**
- mit Staubschutzkappe
- **computer-designte** Schlüssel
- mit M-Wave Banderole

CHAIN LOCK ›C 6.8,5 ILLU‹

- Ø 6 x 850 mm
- textile cover with **reflective stripe**
- **automatic locking**
- with dust cap
- **computer-designed** keys
- with M-Wave banderole



230964 ZAHLEN-KETTENSCHLOSS

›D 6.8,5 ILLU‹

14,90 €



6 x
850

5 x
5

- Ø 6 x 850 mm
- Textilüberzug mit **Reflexstreifen**
- mit **5 Zahlenscheiben**
- mit **verstellbarem**, persönlichem Sicherheitscode
- mit M-Wave Banderole

COMBINATION CHAIN LOCK

›D 6.8,5 ILLU‹

- Ø 6 x 850 mm
- textile cover with **reflective stripe**
- with **5 digits**
- with **changeable**, individual security codes
- with M-Wave banderole



ART.-NR. BESCHREIBUNG
UVP

DESCRIPTION

HEXAGONALSCHLÖSSER



HEXAGONAL LOCKS

233853 SPIRALKABELSCHLOSS

›DS 12.18‹

13,90 €



12x
1.800

- Ø 12 x 1.800 mm
- mattschwarz transparenter, **hexagonaler** Überzug
- **verstellbarer, persönlicher Sicherheitscode**
- universeller Clip-on-Halter für Sattelstütze, Rahmenrohr und für Sattelmuldenbolzen
- auf M-Wave Eurolochkarte

SPIRAL CABLE LOCK

›DS 12.18‹

- Ø 12 x 1,800 mm
- matt black transparent, **hexagonal** cover
- **changeable, individual security code**
- universal clip-on bracket for seat post, frame tube and for seat pin
- on M-Wave eurohole card



233817 SPIRALKABELSCHLOSS ›S 12.18‹

11,90 €



12x
1.800

- Ø 12 x 1.800 mm
- mattschwarz transparenter, **hexagonaler** Überzug
- viele verschiedene **computer-designte** Schlüsselvarianten
- Clip-on-Halter für Sattelstütze und Rahmenrohr zur direkten Befestigung am Schlosskopf
- auf M-Wave Eurolochkarte

SPIRAL CABLE LOCK ›S 12.18‹

- Ø 12 x 1,800 mm
- matt black transparent, **hexagonal** cover
- many different **computer-designed** key variants
- clip-on bracket for seat post and frame tube for direct mounting at the lock head
- on M-Wave eurohole card



SPIRALKABELSCHLÖSSER

SPIRAL CABLE LOCKS

SILICONE

SPIRALKABELSCHLOSS

›DS 12.10 S‹

12x
1.000



- Ø 12 x 1.000 mm
- mit **Silikonüberzug**
- **verstellbarer, persönlicher Sicherheitscode**
- auf M-Wave Eurolochkarte

SPIRAL CABLE LOCK

›DS 12.10 S‹

- Ø 12 x 1,000 mm
- with **silicone cover**
- **changeable, individual security code**
- on M-Wave eurohole card



231060 schwarz

black

231065 grün

green

231067 orange

orange

231068 pink

pink

231069 lila

purple

10,90 €



233855 SPIRALKABELSCHLOSS

›DS 10.18 L‹

14,90 €



10x
1.800



- Ø 10 x 1.800 mm
- dunkel-transparenter Überzug
- **1 blaue LED zur Beleuchtung der Ziffern**
- wahlweise zu öffnen durch **verstellbaren, persönlichen Sicherheitscode** oder durch **computer-designte Schlüssel**
- universeller Clip-on-Halter
- inkl. Batterien (2 x CR 1220)
- auf M-Wave Eurolochkarte

SPIRAL CABLE LOCK

›DS 10.18 L‹

- Ø 10 x 1,800 mm
- dark transparent cover
- **1 blue LED for illumination of the digits**
- can be opened by **changeable, individual security code** or by **computer-designed keys**
- universal clip-on bracket
- incl. batteries (2 x CR 1220)
- on M-Wave eurohole card



ART.-NR. UVP	BESCHREIBUNG	DESCRIPTION	
	<p> SPIRALKABELSCHLOSS ›S 10.18‹</p> <ul style="list-style-type: none"> • Ø 10 x 1.800 mm • Clip-on-Halter (Art. 233849) für Sattelstütze und Rahmenrohr, beidseitig einführbar • mit Staubschutzkappe • auf M-Wave Eurolochkarte 	<p>SPIRAL CABLE LOCK ›S 10.18‹</p> <ul style="list-style-type: none"> • Ø 10 x 1,800 mm • clip-on bracket (art. 233849) for seat post and frame tube, clip-on possibility from both sides • with dust cap • on M-Wave eurohole card 	
230961 8,90 €	dunkel-transparenter Überzug, mit Reflexstreifen	dark transparent cover, with reflective stripe	
233840	dunkel-transparent	dark transparent	
233862	weiß	white	
233863	rot	red	
233864	blau	blue	
233865	grün	green	
233866	gelb	yellow	
233867	orange	orange	
233868	pink	pink	
6,90 €			
	<p> SPIRALKABELSCHLOSS ›S 8.15 S‹</p> <ul style="list-style-type: none"> • Ø 8 x 1.500 mm • mit Silikonüberzug • viele verschiedene computer-designte Schlüsselvarianten • auf M-Wave Eurolochkarte 	<p>SPIRAL CABLE LOCK ›S 8.15 S‹</p> <ul style="list-style-type: none"> • Ø 8 x 1,500 mm • with silicone cover • many different computer-designed key variants • on M-Wave eurohole card 	
231010	schwarz	black	
231015	grün	green	
231017	orange	orange	
231018	pink	pink	
231019	lila	purple	
9,90 €			
	<p> SPIRALKABELSCHLOSS</p> <ul style="list-style-type: none"> • dunkel-transparenter Überzug • verstellbarer, persönlicher Sicherheitscode • Clip-on-Halter (Art. 233849) für Sattelstütze oder Rahmenrohr, beidseitig einführbar • auf M-Wave Eurolochkarte 	<p>SPIRAL CABLE LOCK</p> <ul style="list-style-type: none"> • dark transparent cover • changeable, individual security code • clip-on bracket (art. 233849) for seat post or frame tube, clip-on possibility from both sides • on M-Wave eurohole card 	
230962 8,90 €	› DS 10.18 ILLU ‹ • Ø 10 x 1.800 mm • mit Reflexstreifen	› DS 10.18 ILLU ‹ • Ø 10 x 1,800 mm • with reflective stripe	
230170 7,90 €	› DS 8.15 ‹ Ø 8 x 1.500 mm	› DS 8.15 ‹ Ø 8 x 1,500 mm	
			

ART.-NR. UVP **BESCHREIBUNG**

DESCRIPTION

233830 SPIRALKABELSCHLOSS ›S 8.15‹

SPIRAL CABLE LOCK ›S 8.15‹

8x
1.500

- Ø 8 x 1.500 mm
- dunkel-transparenter Überzug
- Clip-on-Halter (Art. 233849) für Sattelstütze und Rahmenrohr, beidseitig einführbar
- mit **Staubschutzkappe**
- auf M-Wave Eurolochkarte

- Ø 8 x 1,500 mm
- dark transparent cover
- clip-on bracket (art. 233849) for seat post and frame tube, clip-on possibility from both sides
- with **dust cap**
- on M-Wave eurohole card



233822 SPIRALKABELSCHLOSS ›S 6.10‹

SPIRAL CABLE LOCK ›S 6.10‹

6x
1.000

- Ø 6 x 1.000 mm
- dunkel-transparenter Überzug
- Clip-on-Halter (Art. 233849) für Sattelstütze und Rahmenrohr, beidseitig einführbar
- auf M-Wave Eurolochkarte

- Ø 6 x 1,000 mm
- dark transparent cover
- clip-on bracket (art. 233849) for seat post and frame tube, clip-on possibility from both sides
- on M-Wave eurohole card



ZAHLENKABELSCHLÖSSER

DIGIT CABLE LOCKS

SHAPE
MEMORY

KABELSCHLOSS ›D 12.9 MEM‹

CABLE LOCK ›D 12.9 MEM‹

- Ø 12 x 900 mm
- **flexibles TPE-Kabel – lässt sich in beliebige Formen biegen und hält die Form**
- **verstellbarer, persönlicher Sicherheitscode**
- auf M-Wave Eurolochkarte

- Ø 12 x 900 mm
- **flexible TPE cable – can be put into any shape and keeps the shape**
- **changeable, individual security code**
- on M-Wave eurohole card



12x
900

231127 orange

orange

231125 grün

green

231128 pink

pink

9,90 €



SILICONE
TOUCH

KABELSCHLOSS ›DS 12.6,5 S‹

CABLE LOCK ›DS 12.6,5 S‹

- Ø 12 x 650 mm
- mit silikonähnlichem Überzug
- **verstellbarer, persönlicher Sicherheitscode**
- auf M-Wave Eurolochkarte

- Ø 12 x 650 mm
- with silicone like cover
- **changeable, individual security code**
- on M-Wave eurohole card



231050 schwarz

black

231052 weiß

white

231053 rot

red

231054 blau

blue

231055 grün

green

231057 orange

orange

231058 rosa

rose

231059 lila

purple

7,90 €





ART.-NR. UVP	BESCHREIBUNG	DESCRIPTION	
230180 6,90 € 12x 600	KABELSCHLOSS ›D 12.6‹ <ul style="list-style-type: none"> • Ø 12 x 600 mm • geflochtenes Kabel • dunkel-transparenter Überzug • verstellbarer, persönlicher Sicherheitscode • mit Clip-on-Halter für Sattelstütze oder Rahmenrohr • beidseitig einführbar • auf M-Wave Eurolochkarte 	CABLE LOCK ›D 12.6‹ <ul style="list-style-type: none"> • Ø 12 x 600 mm • braided cable • dark transparent cover • changeable, individual security code • with clip-on bracket for seat post or frame tube • clip-on possibility from both sides • on M-Wave eurohole card 	

230101 3,90 € 8x 600	KABELSCHLOSS <ul style="list-style-type: none"> • Ø 8 x 600 mm • dunkel-transparenter Überzug • mit 4 Zahlenscheiben • Montageverpackung 	CABLE LOCK <ul style="list-style-type: none"> • Ø 8 x 600 mm • dark transparent cover • with 4 digits • OEM 	
-----------------------------------	---	--	---

KABELSCHLÖSSER **CABLE LOCKS**

230061 25,90 € 24x12x 1.000 REFLEX	KABELSCHLOSS ›STYLE 23.10‹ <ul style="list-style-type: none"> • (24 x 12) x 1.000 mm • automatische Verriegelung • hohe Sicherheit durch geflochtenes Doppelkabel und Einschub-Bolzen-technik • transparenter Überzug • mit Reflexstreifen • viele verschiedene computer-designte Schlüsselvarianten • erweiterbar durch Anhängen mehrerer Schlösser • auf M-Wave Eurolochkarte 	CABLE LOCK ›STYLE 23.10‹ <ul style="list-style-type: none"> • (24 x 12) x 1,000 mm • automatic locking • high security through braided dual wire innercable and special safety pin technology • transparent cover • with reflective stripe • many different computer-designed key variants • expandable through adding more locks • on M-Wave eurohole card 	 
---	---	---	---

230164 8,90 € 15x 800 REFLEX	KABELSCHLOSS MIT REFLEX-ÜBERZUG ›C15-8 ILLU C‹ <ul style="list-style-type: none"> • Kabelschloss (Art. 230161) • Ø 15 x 800 mm • geflochtenes Kabel • automatische Verriegelung • mit Schlossüberzug (Art. 120999) • 360° reflektierend • auf M-Wave Eurolochkarte 	CABLE LOCK WITH REFLECTIVE COVER ›C15-8 ILLU C‹ <ul style="list-style-type: none"> • cable lock (art. 230161) • Ø 15 x 800 mm • braided design • automatic locking • with lock cover (art. 120999) • 360° reflective • on M-Wave eurohole card 	
---	---	---	---

SILICONE 12x 600	KABELSCHLOSS ›S 12.6 S‹ <ul style="list-style-type: none"> • Ø 12 x 600 mm • mit Silikonüberzug • viele verschiedene computer-designte Schlüsselvarianten • auf M-Wave Eurolochkarte 	CABLE LOCK ›S 12.6 S‹ <ul style="list-style-type: none"> • Ø 12 x 600 mm • with silicone cover • many different computer-designed key variants • on M-Wave eurohole card 	 
231040	schwarz	black	
231045	grün	green	
231047	orange	orange	
231048	pink	pink	
231049	lila	purple	
7,90 €			

230960 6,90 € REFLEX 15x 800	KABELSCHLOSS ›C 15.8 ILLU‹ <ul style="list-style-type: none"> • Ø 15 x 800 mm • geflochtenes Kabel • dunkel-transparenter Überzug • mit Reflexstreifen • automatische Verriegelung • auf M-Wave Eurolochkarte 	CABLE LOCK ›C 15.8 ILLU‹ <ul style="list-style-type: none"> • Ø 15 x 800 mm • braided design • dark transparent cover • with reflective stripe • automatic locking • on M-Wave eurohole card 	
---	--	---	---

Locks

ART.-NR. BESCHREIBUNG
UVP

DESCRIPTION

PANZERGLIEDERSCHLÖSSER

JOINT ARMORED LOCKS

230815 PANZERGLIEDERSCHLOSS
›H 24.10‹

14,90 €

24x
1.000

- Ø 24 x 1.000 mm
- **starke Ausführung**
- dunkel-transparenter Überzug
- viele verschiedene **computer-designte** Schlüsselvarianten
- auf M-Wave Eurolochkarte

JOINT ARMORED LOCK
›H 24.10‹

- Ø 24 x 1,000 mm
- **heavy duty**
- dark transparent cover
- many different **computer-designed** key variants
- on M-Wave eurohole card



230186 PANZERGLIEDERSCHLOSS
›HD 18.8‹

11,90 €

18x
800

5
5
5
5
5

- Ø 18 x 800 mm
- starke Ausführung
- dunkel-transparenter Überzug
- **5 Zahlenscheiben**
- **verstellbarer**, persönlicher Sicherheitscode
- auf M-Wave Eurolochkarte

JOINT ARMORED LOCK
›HD 18.8‹

- Ø 18 x 800 mm
- heavy duty
- dark transparent cover
- **5 digits**
- **changeable**, individual security code
- on M-Wave eurohole card



230810 PANZERGLIEDERSCHLOSS
›H 18.8‹

7,90 €

18x
800

- Ø 18 x 800 mm
- mit **Staubschutzkappe**
- dunkel-transparenter Überzug
- auf M-Wave Eurolochkarte

JOINT ARMORED LOCK
›H 18.8‹

- Ø 18 x 800 mm
- with **dust cap**
- dark transparent cover
- on M-Wave eurohole card



KETTENSCHLÖSSER

CHAINLOCKS

230950 KETTENSCHLOSS ›C 10.9-360‹

49,90 €

10 x 10 x
900



- 10 x 10 x 900 mm
- **besonders widerstandsfähig** durch **gehärtete quadratische Kettenglieder** und **robusten Schließzylinder**
- viele verschiedene **computer-designte** Schlüsselvarianten
- **360° drehbarer Verschlusskopf**
- mit Staubschutzkappe
- mit Textilüberzug
- mit M-Wave Banderole

CHAIN LOCK ›C 10.9-360‹

- 10 x 10 x 900 mm
- **very robust** because of **hardened square chain links** and **robust cylinder lock**
- many different **computer-designed** key variants
- **360° turnable lock head**
- with dust cap
- with textile cover
- with M-Wave banderole



230313 KETTENSCHLOSS ›C 10.11‹

24,90 €

10 x 10 x
1.100



- 10 x 10 x 1.100 mm
- **besonders widerstandsfähig** durch **quadratische Kettenglieder**
- **automatische Verriegelung**
- viele verschiedene **computer-designte** Schlüsselvarianten
- mit Textilüberzug
- mit **Staubschutzkappe**
- mit M-Wave Banderole

CHAIN LOCK ›C 10.11‹

- 10 x 10 x 1,100 mm
- **very robust** because of **square chain links**
- **automatic locking**
- many different **computer-designed** key variants
- with textile cover
- with **dust cap**
- with M-Wave banderole



ART.-NR. UVP	BESCHREIBUNG	DESCRIPTION	
  	KETTENSCHLOSS <ul style="list-style-type: none"> • Ø 6 x 850 mm • automatische Verriegelung • mit Staubschutzkappe • viele verschiedene computer-designte Schlüsselvarianten • mit Textilüberzug • mit M-Wave Banderole 	CHAIN LOCK <ul style="list-style-type: none"> • Ø 6 x 850 mm • automatic locking • with dust cap • many different computer-designed key varieties • with textile cover • with M-Wave banderole 	
	230963 ›C 6.8,5 ILLU‹ 14,90 € mit Reflexstreifen	›C 6.8,5 ILLU‹ with reflective stripe	
230315 ›C 6.8,5‹ 13,90 € ohne Reflexstreifen	›C 6.8,5‹ without reflective stripe		
  	ZAHLEN-KETTENSCHLOSS <ul style="list-style-type: none"> • Ø 6 x 850 mm • mit 5 Zahlenscheiben • mit verstellbarem, persönlichem Sicherheitscode • mit Textilüberzug • mit M-Wave Banderole 	COMBINATION CHAIN LOCK <ul style="list-style-type: none"> • Ø 6 x 850 mm • with 5 digits • with changeable, individual security codes • with textile cover • with M-Wave banderole 	
	230964 ›D 6.8,5 ILLU‹ 14,90 € mit Reflexstreifen	›D 6.8,5 ILLU‹ with reflective stripe	
230316 ›D 6.8,5‹ 13,90 € ohne Reflexstreifen	›D 6.8,5‹ without reflective stripe		
	230317 ZAHLEN-KETTENSCHLOSS ›D 3,5,9‹ 8,90 €	COMBINATION CHAIN LOCK ›D 3,5,9‹	
 	<ul style="list-style-type: none"> • Ø 3,5 x 900 mm • mit verstellbarem, persönlichem Sicherheitscode • mit Textilüberzug • mit M-Wave Banderole 	<ul style="list-style-type: none"> • Ø 3.5 x 900 mm • with changeable, individual security code • with textile cover • with M-Wave banderole 	

FALTSCHLÖSSER

FOLDING LOCKS

- 230196 FALT-DISC-SCHLOSS** ›F 600 D‹
34,90 €
- 
- 14 **starke**, halbrunde **Stahlglieder** mit Kunststoffüberzug
 - Länge 600 mm
 - **kompaktes faltmaß**, ca. 7 cm x 5 cm
 - mit 2 Schlüsseln
 - mit Clip-on-Halter (Art. 230198)
 - Schloss **diebstahlsicher** am Halter fixierbar
 - in M-Wave Blisterverpackung

- FOLDING DISC LOCK** ›F 600 D‹
- 14 **strong**, half-rounded **steel links** with plastic cover
 - length 600 mm
 - **compact folding size**, approx. 7 cm x 5 cm
 - with 2 keys
 - with clip-on bracket (art. 230198)
 - **anti-theft-secured** fixing at the bracket
 - in M-Wave blister packaging



ART.-NR. BESCHREIBUNG
UVP

DESCRIPTION

230187 FALTSCHLOSS ›F 1240/8‹

48,90 €

1.240 mm

XL



- **XL:** Länge **1.240 mm**
- **8 Glieder aus gehärtetem Stahl** mit Kunststoffummantelung, 8 x 25 x 165 mm
- kompaktes Faltmaß: 210 x 92 x 50 mm
- mit **Halterung** und Klettverschlüssen zur flexiblen Rahmenbefestigung oder zur Montage an den Flaschenhalterösen
- 2 Schlüssel, davon **eine mit LED-Beleuchtung**, inkl. Batterien (1x CR 1220)
- in M-Wave Blisterverpackung

FOLDING LOCK ›F 1240/8‹

- **XL:** length **1,240 mm**
- **8 hardened steel links** with plastic cover, 8 x 25 x 165 mm
- folded size: 210 x 92 x 50 mm
- with **bracket** and hook and loop fasteners for flexible frame attachment or mounting to the bottle cage eyelets
- 2 keys, **one with LED light**, incl. batteries (1x CR 1220)
- in M-Wave blister packaging



FALTSCHLOSS

875 mm



- Länge **875 mm**
- **6 Glieder aus gehärtetem Stahl** mit Kunststoffummantelung, 8 x 25 x 152 mm
- kompaktes Faltmaß: 195 x 72 x 50 mm
- mit **Halterung** und Klettverschlüssen zur Rahmenbefestigung oder zur Montage an den Flaschenhalterösen
- 2 Schlüssel

FOLDING LOCK

- length **875 mm**
- **6 hardened steel links** with plastic cover, 8 x 25 x 152 mm
- folded size: 195 x 72 x 50 mm
- with **bracket** and velcros for frame mounting or mounting to the bottle cage eyelets
- 2 keys



230194 ›F 875/6‹

34,90 €

1 Schloss in M-Wave Blisterverpackung

›F 875/6‹

1 lock in M-Wave blister packaging

230197 ›F 875/6 TWIN‹

58,90 € / set

2x

- **Set aus zwei Schlössern** mit je **2 identischen Schlüsseln**, die je in beide Schließzylinder passen
- 2 Schlösser in M-Wave Blisterverpackung

›F 875/6 TWIN‹

- **set of two locks**, each with **2 identical keys**, which fit in both key cylinders
- 2 locks in M-Wave blister packaging



234000 ALARMANLAGE ›WATCH DOG‹

16,90 €



- automatische Alarmierung durch **Bewegungssensor**
- Sensibilität **einstellbar**
- Lautstärke **120 db**
- Codierung mit 3 Zahlen persönlich **einstellbar**
- Halter für Rohr-Ø 25 - 30 mm
- inkl. Batterie (9 V)
- auf M-Wave Eurolochkarte

ALARM SYSTEM ›WATCH DOG‹

- automatic alarm by **movement sensor**
- **adjustable** sensitivity
- loudness **120 db**
- **adjustable** encoding by 3 numbers
- bracket for tubes with Ø 25 - 30 mm
- incl. battery (9 V)
- on M-Wave eurohole card



230054 ALARMSCHLOSS ›LOCK'N'ROLL ALARM‹

29,90 €



1.6x 730

- Kleines, leichtes Aufrollschloss mit Alarmfunktion!
- **Alarm** bei **Bewegung** oder **Durchtrennen** des Kabels
- **Empfindlichkeit einstellbar**
- Lautstärke **90 db**
- nur 84 g (o. Batterien)
- mit **4 Zahlenscheiben**
- mit **verstellbarem**, persönlichem **Sicherheitscode**
- Kabel **1,6 x 730 mm**
- schwarzes Gehäuse
- inkl. Batterien
- in M-Wave Blisterverpackung

ALARM LOCK ›LOCK'N'ROLL ALARM‹

- Small, light roll-up lock with alarm function!
- **alarm** when lock is **moved** or cable is **cut**
- **adjustable sensitivity**
- loudness **90 db**
- only 84 g (w/o batteries)
- with **4 digits**
- with **changeable**, individual **security code**
- cable **1.6 x 730 mm**
- black housing
- incl. batteries
- in M-Wave blister packaging



230051 AUFROLL-KABELSCHLOSS ›LOCK'N'ROLL D 24.9‹

9,90 €

2.4x 900

- Klein, leicht und praktisch! Durch Knopfdruck rollt sich das Kabel selbst auf.
- mit **4 Zahlenscheiben**
- mit **verstellbarem**, persönlichem **Sicherheitscode**
- Kabel **2,4 x 900 mm**
- Gehäuse dunkel-transparent
- auf M-Wave Eurolochkarte

ROLL UP CABLE LOCK ›LOCK'N'ROLL D 24.9‹

- Small, light and handy! By pressing the button the cable rolls up automatically.
- with **4 digits**
- with **changeable**, individual security code
- cable **2.4 x 900 mm**
- dark transparent housing
- on M-Wave eurohole card



ART.-NR. UVP	BESCHREIBUNG	DESCRIPTION
-----------------	--------------	-------------

ABSPERRKABEL

- mit 2 **Schlaufenenden**
- zur **Verlängerung des Absperrradius**
- ideal um mehrere Räder zu sichern
- ideal auch in Verbindung mit kleinen Bügelschlössern z. B. Art. 230121, ...
- auf M-Wave Eurolockkarte

LOCK CABLE

- with 2 **loopends**
- for **extending the locking range**
- protection of multiple bicycles
- ideal in conjunction with small u-locks e. g. art. 230121, ...
- on M-Wave eurohole card



230340 ›S 10.50 L‹
14,90 € 10 x 5.000 mm

›S 10.50 L‹
10 x 5,000 mm

10x
5.000

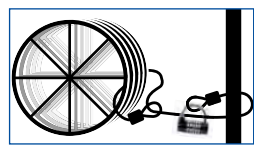

230130 ›S 8.18 L‹
4,90 € 8 x 1.800 mm

›S 8.18 L‹
8 x 1,800 mm

8x
1.800

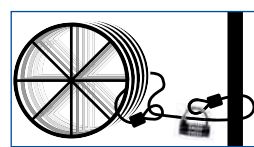

VORHÄNGESCHLOSS ›PD 5‹
5x

- mit 5 **Zahlenscheiben**
- mit **verstellbarem**, persönlichem Sicherheitscode
- Bügel aus **gehärtetem Stahl**
- 7 mm Bügelstärke

PADLOCK ›PD 5‹

- with 5 **digits**
- with **changeable**, individual security code
- **hardened steel** shackle
- 7 mm shackle thickness

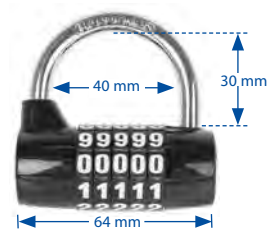

230121 auf M-Wave Eurolockkarte

on M-Wave eurohole card

230120 Montageverpackung
8,90 €

OEM

230124 **VORHÄNGESCHLOSS** ›PD 3 L‹
4,90 €

- mit 3 **Zahlscheiben**
- mit Mini-Spiralkabel **3 x 1200 mm**
- Überzug transparent smoke
- mit **verstellbarem**, persönlichem Sicherheitscode
- auch geeignet zum Sichern von Taschen, Helmen am Fahrrad, ...
- auf M-Wave-Eurolockkarte

PADLOCK ›PD 3 L‹

- with 3 **digits**
- with mini spiral cable **3 x 1200 mm**
- cover transparent smoke
- with **changeable**, individual security code
- also suitable to secure bags, helmets on the bike, ...
- on M-Wave eurohole card



BÜGELSCHLÖSSER

U-LOCKS

234022 ZAHLEN-BÜGELSCHLOSS ›BD 260‹

21,90 €

- mit Halter
- mit **4 Zahlenscheiben**
- mit **verstellbarem**, persönlichem Sicherheitscode
- Ø 14 mm Bügelstärke
- Außenmaß: 124 x 260 mm
- Innenmaß: 76 x 200 mm
- mit M-Wave Banderole

DIGIT U-LOCK ›BD 260‹

- with bracket
- with **4 digits**
- with **changeable**, individual security code
- Ø 14 mm shackle thickness
- outer size: 124 x 260 mm
- inner size: 76 x 200 mm
- with M-Wave banderole

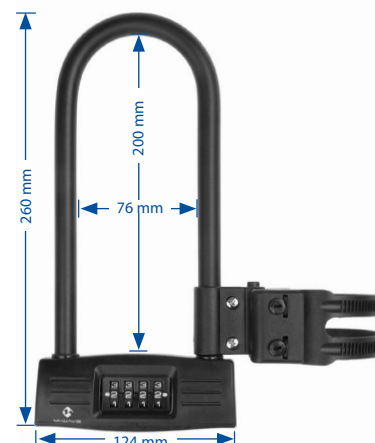

234025 BÜGELSCHLOSS MIT SPIRALKABEL ›B & S‹

19,90 €

- Set aus **Bügel Schloss** und **Spiralkabel**
- zur optimalen Sicherung des Fahrrads
- mit M-Wave Banderole

- Spiralkabel mit Schlaufen** (Art. 230130)
- **8 x 1.800 mm**
 - mit 2 unterschiedlich großen **Schlaufenenden**
 - zur **Verlängerung des Absperrradius**

- Bügel Schloss** (Art. 234012)
- mit Halter und Staubschutzkappe
 - **erhöhte Sicherheit** durch quadratische Form
 - Ø 15 mm Bügelstärke
 - Außenmaß: 165 x 247 mm
 - Innenmaß: 106 x 188 mm
 - viele verschiedene **computer-designte** Schlüsselvarianten

U-LOCK WITH SPIRAL CABLE ›B & S‹

- set of **u-lock** and **spiral cable**
- for optimum protection of the bicycle
- with M-Wave banderole

- loop spiral cable** (art. 230130)
- **8 x 1,800 mm**
 - with 2 **loopends** of different size
 - for **extending the locking range**

- u-lock** (art. 234012)
- with bracket and dust cap
 - **increased security** through square shape
 - Ø 15 mm shackle thickness
 - outer size: 165 x 247 mm
 - inner size: 106 x 188 mm
 - many different **computer-designed** key variants

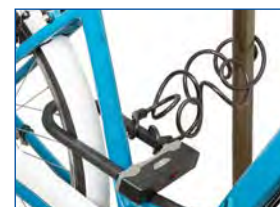
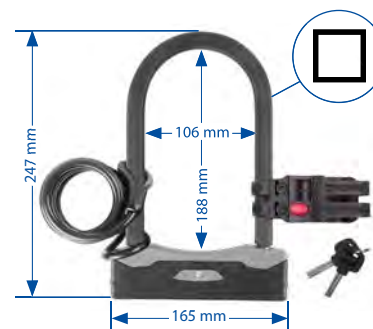

234012 BÜGELSCHLOSS ›B 247‹

14,90 €

- mit Halter und Staubschutzkappe
- **erhöhte Sicherheit** durch quadratische Form
- **Ø 15 mm** Bügelstärke
- Außenmaß: 165 x 247 mm
- Innenmaß: 106 x 188 mm
- viele verschiedene **computer-designte** Schlüsselvarianten
- mit M-Wave Banderole

U-LOCK ›B 247‹

- with bracket and dust cap
- **increased security** through square shape
- **Ø 15 mm** shackle thickness
- outer size: 165 x 247 mm
- inner size: 106 x 188 mm
- many different **computer-designed** key variants
- with M-Wave banderole

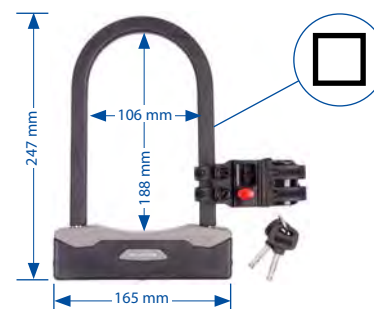

234010 BÜGELSCHLOSS ›B 245‹

12,90 €

- mit Halter und Staubschutzkappe
- **Ø 14 mm** Bügelstärke
- Außenmaß: 197 x 245 mm
- Innenmaß: 105 x 205 mm
- viele verschiedene **computer-designte** Schlüsselvarianten
- mit M-Wave Eurolochkarte

U-LOCK ›B 245‹

- with bracket and dust cap
- **Ø 14 mm** shackle thickness
- outer size: 197 x 245 mm
- inner size: 105 x 205 mm
- many different **computer-designed** key variants
- with M-Wave eurohole card

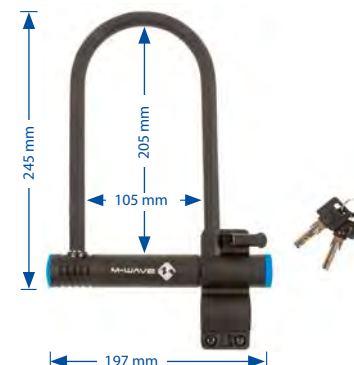

ART.-NR. BESCHREIBUNG
UVP

DESCRIPTION

RAHMENSCHLÖSSER

FRAME LOCKS

RAHMENSCHLOSS ›BOOSTER‹

- **Fahrradschloss und Brake-Booster**
- kann sowohl bei **gedeferten, als auch ungefederten** Rädern an den Brems-Pivots der **Vorderradgabel und des Hinterbaus** montiert werden
- zusätzliche Befestigungsmöglichkeit **an der Platte zwischen den Sitzrohrstreben**
- auf M-Wave Eurolochkarte

FRAME LOCK ›BOOSTER‹

- **bicycle lock and brake booster**
- can be mounted on bikes **with suspension** or bikes **w/o suspension** on the brake-pivots of **front fork and seat stays**
- also possible to fasten **on the seat stay plate**
- on M-Wave eurohole card



231440 silber

silver

231441 schwarz

black

29,90 €

231451 RAHMENSCHLOSS MIT KETTE ›RINGCHAIN XL‹

24,90 €

5,5 x 5,5 x 1.000



- **70 mm Durchlaufbreite** für **besonders breite Reifen**
- für Montage an der Pletscherplatte oder den Sitzrohrstreben
- mit **quadratischen Kettengliedern**, 5,5 x 5,5 x **1.000 mm** (Art. 231452) zur **Verlängerung des Absperrradius**, mit schwarzem Textilüberzug
- Kette mit Kletttrienen zum Aufrollen und Fixieren
- mit Befestigungsmaterial
- auf M-Wave Eurolochkarte

FRAME LOCK WITH CHAIN ›RINGCHAIN XL‹

- **70 mm inner width** for **very wide tires**
- for mounting on the Pletscher plate or seat stays
- with **square chain links**, 5,5 x 5,5 x **1,000 mm** (art. 231452) for **extending the locking range**, with black textile cover
- chain with hook and loop straps for rolling up and fixing
- with mounting material
- on M-Wave eurohole card



5,5 x 5,5



SCHLOSSKETTE

- **Ersatz-/Verlängerungskette** für Rahmenschloss Art. 231451 und **andere Rahmenschlösser**
- zur Verlängerung des Absperrradius
- mit schwarzem Textilüberzug
- Kette mit Kletttrienen zum Aufrollen und Fixieren
- Montageverpackung

LOCK CHAIN

- **replacement and extension chain** for frame lock art. 231451 and **other frame locks**
- for extending the locking range
- with black textile cover
- chain with hook and loop straps for rolling up and fixing
- OEM



231452 ›C 5,5.10‹
5,5 x 5,5 x 1.000 mm
9,90 €

›C 5,5.10‹
5.5 x 5.5 x 1,000 mm

231453 ›C 5,5.14‹
5,5 x 5,5 x 1.400 mm
11,90 €

›C 5,5.14‹
5.5 x 5.5 x 1,400 mm



122357 AUFBEWAHRUNGSTASCHE FÜR SCHLOSSKETTEN ›TILBURG M‹

6,90 €

- mit Clip-on-Halter (Art. 122299)
- durch Reißverschluss nach unten **erweiterbar**
- mit **Rücklichthalter** und 3 **Kletttrienen** unten (z. B. für Luftpumpe)
- mit Reflexstreifen
- Größe: ca. 160 x 80 mm
- Höhe: ca. 80 - 150 mm

STORAGE BAG FOR LOCK CHAINS ›TILBURG M‹

- with clip-on bracket (art. 122299)
- through zipper **expandable** at the bottom
- with **light bracket** and 3 **hook and loop fasteners** at the bottom (e. g. for pump)
- with reflective stripes
- size: approx. 160 x 80 mm
- height: approx. 80 - 150 mm



ART.-NR. UVP **BESCHREIBUNG**

DESCRIPTION

231458 RAHMENSCHLOSS MIT KETTE ›RINGCHAIN‹

21,90 €

5,5 x
5,5 x
1.500



- 63 mm Durchlaufbreite
- **inkl. quadratischen Kettengliedern** 5,5 x 5,5 x 1.500 mm mit Textilüberzug
- Kette mit Klettarmen zum Aufrollen und Fixieren
- mit zwei Schrauben und abnehmbarem Distanzstück für Montage an der Pletscherplatte
- auf M-Wave Eurolochkarte

FRAME LOCK WITH CHAIN ›RINGCHAIN‹

- 63 mm inner width
- **incl. square chain links** 5.5 x 5.5 x 1,500 mm with textile cover
- chain with hook and loop straps for rolling up and fixing
- with two screws and detachable spacers for mounting on the Pletscher plate
- on M-Wave eurohole card



231465 RAHMENSCHLOSS MIT KABEL ›RINGLOOP‹

18,90 €

- 63 mm Durchlaufbreite
- **inkl. Befestigungskabel** 10 x 1.500 mm
- inkl. Halter für Kabel
- Kabel **abnehmbar**
- mit zwei Schrauben und abnehmbarem Distanzstück für Montage an der Pletscherplatte
- auf M-Wave Eurolochkarte

FRAME LOCK WITH CABLE ›RINGLOOP‹

- 63 mm inner width
- **incl. fixation cable** 10 x 1,500 mm
- incl. holder for cable
- cable **removable**
- with two screws and detachable spacers for mounting on the Pletscher plate
- on M-Wave eurohole card

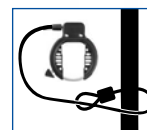

231470 RAHMENSCHLOSS ›XL RING‹

14,90 €

- **70 mm Durchlaufbreite** für besonders **breite Reifen**
- 2 Schlüssel mit **Licht**
- mit zwei Schrauben und abnehmbarem Distanzstück für Montage an der Pletscherplatte
- Montageverpackung

FRAME LOCK ›XL RING‹

- **70 mm inner width** for **very wide tires**
- 2 keys with **light**
- with two screws and detachable spacers for mounting on the Pletscher plate
- OEM



RAHMENSCHLOSS ›RING‹

- 64 mm Durchlaufbreite
- Montageverpackung

FRAME LOCK ›RING‹

- 64 mm inner width
- OEM

231461 mit abnehmbarem Distanzstück zur Montage an der Pletscherplatte

with **detachable spacer** for mounting on Pletscher plate

231464 ohne Bolzen und Distanzhülsen

9,90 €

without bolts and spacers



ART.-NR. UVP **BESCHREIBUNG**

DESCRIPTION

M-WAVE COMPUTER – KLEINER PREIS – GROSSE LEISTUNG

- **gut lesbares** und temperaturbeständiges Display
- **japanische Batterien**
- doppelte **Qualitätskontrolle**
- super Preis-Leistungsverhältnis

M-WAVE COMPUTER – LOW PRICE – BIG PERFORMANCE

- **easy-to-read** and temperature-resistant display
- **Japanese batteries**
- double **quality check**
- super price-performance ratio

244750 FAHRRADCOMPUTER ›M21W‹

26,90 €

21 Funktionen mit Touchscreen und Funkübertragung:



- Geschwindigkeit: akt. / Ø / max.
- Geschwindigkeitsvergleich
- Gesamt- / Tageskilometer
- Kilometerstand speichern
- automatischer Fahrzeitmesser
- automatischer Anzeigenwechsel
- Digitaluhr
- Stoppuhr
- Kalorienzähler
- Temperaturanzeige
- Auto Start / Stopp
- Kilometer- / Meilenauswahl
- Displaybeleuchtung
- Service Programm
- Screenshot-Funktion
- Batteriezustandsanzeige
- inkl. Batterien (CR 2032, Art. 640814)
- Montage am **Lenker oder Vorbau**
- Ersatz-/Zusatzhalter-Set Art. 244797



BICYCLE COMPUTER ›M21W‹

21 functions with touchscreen and wireless transmission:

- speed: current / Ø / max.
- speed comparator
- total distance / trip distance
- odometer save function
- auto trip timer
- auto scan
- digital clock
- stopwatch
- calorie consumption
- temperature
- auto start / stop
- kilometres / miles selection
- display backlight
- service program
- freeze frame function
- battery level indicator
- incl. batteries (CR 2032, art. 640814)
- mounting at the **handlebar or stem**
- additional replacement bracket set art. 244797



244732 FAHRRADCOMPUTER ›M14W‹

28,90 €

14 Funktionen mit digitaler Funkübertragung:



- Geschwindigkeit: akt. / Ø / max.
- Geschwindigkeitstendenz / -vergleich
- Gesamt- / Tageskilometer
- Kilometerstand speichern
- automatischer Fahrzeitmesser
- automatischer Anzeigenwechsel
- Screenshot-Funktion
- Digitaluhr
- Auto Start / Stopp
- Auto An / Aus
- Kilometer- / Meilenauswahl
- Raddurchmesser einstellbar
- wassergeschützt (IP 44)
- inkl. Batterien (CR 2032, Art. 640814)
- **werkzeuglose Montage** am Lenker oder Vorbau (Ersatz-/Zusatzhalter-Set Art. 244796)
- Anleitungen in CS, DE, EN, FR, HU, IT, NL, PL

BICYCLE COMPUTER ›M14W‹

14 functions with digital wireless transmission:

- speed: current / Ø / max.
- speed tendency / speed comparator
- total distance / trip distance
- odometer save function
- auto trip timer
- auto scan
- freeze frame function
- digital clock
- auto start / stop
- auto power on / off
- kilometres / miles selection
- adjustable wheel size
- water protected (IP 44)
- incl. batteries (CR 2032, art. 640814)
- **toolless mounting** at the handlebar or stem (additional replacement bracket set art. 244796)
- manuals in CS, DE, EN, FR, HU, IT, NL, PL



ART.-NR. UVP **BESCHREIBUNG**

DESCRIPTION

244733 FAHRRADCOMPUTER ›M16‹

16,90 €

16 Funktionen:

- Geschwindigkeit: akt. / Ø / max.
- Geschwindigkeitstendenz / -vergleich
- Gesamt- / Tageskilometer
- Kilometerstand speichern
- automatischer Fahrzeitmesser
- automatischer Anzeigenwechsel
- Service Programm
- Screenshot-Funktion
- Digitaluhr
- Temperaturanzeige: °C / °F wählbar
- Auto Start / Stopp
- Auto An / Aus
- Kilometer- / Meilenauswahl
- Raddurchmesser einstellbar
- wassergeschützt (IP 44)
- inkl. Batterie (CR 2032, Art. 640814)
- **werkzeuglose Montage** am Lenker oder Vorbau (Ersatz- / Zusatzhalter-Set Art. 244795)
- Anleitungen in CS, DE, EN, FR, HU, IT, NL, PL



BICYCLE COMPUTER ›M16‹

16 functions:

- speed: current / Ø / max.
- speed tendency / speed comparator
- total distance / trip distance
- odometer save function
- auto trip timer
- auto scan
- service program
- freeze frame function
- digital clock
- temperature: °C / °F selectable
- auto start / stop
- auto power on / off
- kilometres / miles selection
- adjustable wheel size
- water protected (IP 44)
- incl. batteries (CR 2032, art. 640814)
- **toolless mounting** at the handlebar or stem (additional replacement bracket set art. 244795)
- manuals in CS, DE, EN, FR, HU, IT, NL, PL



244734 FAHRRADCOMPUTER ›M12‹

15,90 €

12 Funktionen:

- Geschwindigkeit: akt. / Ø / max.
- Geschwindigkeitstendenz / -vergleich
- Gesamt- / Tageskilometer
- automatischer Fahrzeitmesser
- automatischer Anzeigenwechsel
- Digitaluhr
- Auto Start / Stopp
- Auto An / Aus
- Kilometer- / Meilenauswahl
- Raddurchmesser einstellbar
- wassergeschützt (IP 44)
- inkl. Batterie (CR 2032, Art. 640814)
- **werkzeuglose Montage** am Lenker oder Vorbau (Ersatz- / Zusatzhalter-Set Art. 244795)
- Anleitungen in CS, DE, EN, FR, HU, IT, NL, PL



BICYCLE COMPUTER ›M12‹

12 functions:

- speed: current / Ø / max.
- speed tendency / comparator
- total distance / trip distance
- auto trip timer
- auto scan
- digital clock
- auto start / stop
- auto power on / off
- kilometres / miles selection
- adjustable wheel size
- water protected (IP 44)
- incl. batteries (CR 2032, art. 640814)
- **toolless mounting** at the handlebar or stem (additional replacement bracket set art. 244795)
- manuals in CS, DE, EN, FR, HU, IT, NL, PL



FAHRRADCOMPUTER ›XIV SILICONE‹

Mit farbigen, austauschbaren Silikonhüllen

14 Funktionen:

- **digitale Funkübertragung**
- Geschwindigkeit: akt. / Ø / max.
- Geschwindigkeitstendenz / -vergleich
- Gesamt- / Tageskilometer
- automatischer Anzeigenwechsel
- Uhrzeit
- CO²-Ersparnis
- Kalorienzähler
- Temperaturanzeige: °C / °F wählbar
- Auto Start / Stopp
- Kilometer- / Meilenauswahl
- Raddurchmesser einstellbar
- inkl. Batterie (L1154F, Art. 640818)
- wassergeschützt
- **werkzeuglose Montage** am Lenker oder Vorbau und um **90° drehbar**
- Anleitungen in CS, DE, EN, FR, HU, IT, NL, PL



90°

BICYCLE COMPUTER ›XIV SILICONE‹

With coloured, exchangeable silicone covers

14 functions:

- **digital wireless transmission**
- speed: current / Ø / max.
- speed tendency / comparator
- total distance / trip distance
- auto scan
- clock
- CO² emission reduction
- calorie consumption
- temperature: °C / °F selectable
- auto start / stop
- kilometres / miles selection
- adjustable wheel size
- incl. battery (L1154F, art. 640818)
- water protected
- **toolless mounting** at the handlebar or stem and **90° rotatable**
- manuals in CS, DE, EN, FR, HU, IT, NL, PL



244710 schwarze Silikonhülle

31,90 €

244714 gelbe Silikonhülle

244715 rosa Silikonhülle

244718 orange Silikonhülle





26,90 €

black silicone cover

yellow silicone cover

rose silicone cover

orange silicone cover

ART.-NR. UVP	BESCHREIBUNG	DESCRIPTION	
	ERSATZTEILE FÜR COMPUTER	SPARE PARTS FOR COMPUTER	
244799 29,90 € / set	Ersatz- / Zusatzsender <ul style="list-style-type: none"> • Geschwindigkeitssensor und Trittfrequenzsensor • für kabellose Fahrradcomputer Art. 244730 und 244731 • inkl. Batterien • inkl. Montagematerial • Montageverpackung 	Replacement / additional transmitters <ul style="list-style-type: none"> • sensor for speed and cadence • for wireless bicycle computers art. 244730 and 244731 • incl. batteries • incl. mounting material • OEM 	
244796 4,90 € / set	Ersatz- / Zusatzhalter-Set <ul style="list-style-type: none"> • für kabellose Fahrradcomputer Art. 244730, 244731 und 244732 • im Polybeutel mit M-Wave Header 	Replacement / additional bracket set <ul style="list-style-type: none"> • for wireless bicycle computers art. 244730, 244731 and 244732 • in PE bag with M-Wave header 	
244795 5,90 € / set	Ersatz- / Zusatzhalter-Set <ul style="list-style-type: none"> • für Fahrradcomputer Art. 244733 und 244734 • im Polybeutel mit M-Wave Header 	Replacement / additional bracket set <ul style="list-style-type: none"> • for bicycle computers art. 244733 and 244734 • in PE bag with M-Wave header 	
	HALTER FÜR AIRTAG 'AIRCASE BC'	BRACKET FOR AIRTAG 'AIRCASE BC'	
	<ul style="list-style-type: none"> • ermöglicht die unauffällige Anbringung des Apple AirTag Senders unter dem Flaschenhalter • inkl. längerer Schrauben 	<ul style="list-style-type: none"> • enables the Apple AirTag transmitter to be unobtrusively attached under the bottle cage • incl. extra long screws 	
245026	auf M-Wave Eurolochkarte	on M-Wave eurohole card	
245025 14,90 €	Montageverpackung	OEM	



M-WAVE

YOUR WORLD OF CYCLING

ART.-NR. UVP **BESCHREIBUNG**

DESCRIPTION

MODULARES HALTER-SYSTEM ›QRIR‹

- **vielseitige Kombinationsmöglichkeiten** von Haltern und Adaptern für Lampen, Trinkflaschen, Fahrrad-computer, Action-Kameras, ...
- optimale Anpassung an die **individuellen Bedürfnisse** jedes Rad-fahrers
- **CNC-gefrästes Aluminium**
- Verbindungs-Konstruktion auch für GoPro geeignet (keine original GoPro Ersatzteile)
- auf M-Wave Eurolochkarte

ADAPTER

- für Ahead Steuersatz
- 1 1/8" und verjüngt
- für Flaschenhalter-Adapter (Art. 390636), Lenkercockpit (Art. 390637) oder Lampenhalter (Art. 390638)

390650 Distanzring ›QRIR Spacer‹
Höhe: 10 mm
7,90 €

390635 Ahead-Kappe ›QRIR Top‹
8,90 €

MODULAR BRACKET SYSTEM ›QRIR‹

- **versatile combinations** of brackets and adapters for lamps, water bottles, cycle computers, action cams, ...
- optimal adaptation to the **individual needs** of every cyclist
- **CNC machined aluminium**
- connection construction also suitable for GoPro (no original GoPro spare parts)
- on M-Wave eurohole card

ADAPTER

- for ahead head set
- 1 1/8" and tapered
- for bottle cage adapter (art. 390636), handlebar cockpit (art. 390637) or lamp bracket (art. 390638)

Spacer ›QRIR Spacer‹
height: 10 mm

Ahead cap ›QRIR Top‹

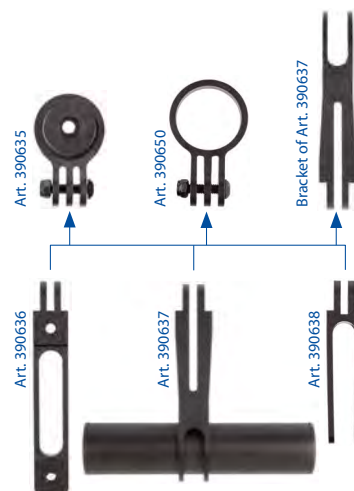

HALTER

für Distanzring (Art. 390650) und Ahead-Kappe (Art. 390635)

390637 Lenkercockpit ›QRIR Cockpit‹
12,90 €

- universelle Montage von Lampen, Fahrradcomputern, E-Bike Displays, ...
- Klemmdurchmesser: 22,2 mm
- Rohr: 90 x 22,2 mm
- **Zusatzfunktion:** Bei Entnahme des "Cockpit-Rohres" ist eine umgekehrte Montage am Lenker möglich. So können die Halter Art. 390636/8, Scheinwerfer, ... problemlos im **Ø 22,2 mm-Klemmbereich des Lenkers** montiert werden.

BRACKET

for spacer (art. 390650) and ahead cap (art. 390635)

Handlebar cockpit ›QRIR Cockpit‹

- universal mounting of lamps, bicycle computers, e-bike displays ...
- clamp diameter: 22.2 mm
- tube: 90 x 22.2 mm
- **additional function:** When removing the "cockpit tube" a reverse mounting on the handlebar is possible. Thus, the brackets art. 390636/8, head lights, ... can be easily mounted at the **Ø 22.2 mm clamp area of the handlebar**.

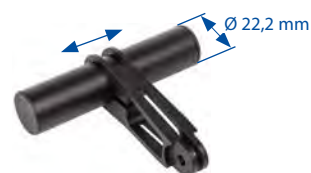

390636 Flaschenhalter ›QRIR Bottle‹
7,90 €

- zur Montage eines Flaschenhalters
- Winkel stufenlos einstellbar

Bottle cage ›QRIR Bottle‹

- for mounting of a bottle cage
- steplessly adjustable angle



390638 Lampenhalter ›QRIR Extender‹
7,90 €

- zur Montage eines Scheinwerfers
- auch in Kombination mit der Klemme des Lenkercockpits (Art. 390637) im **Ø 22,2 mm-Klemmbereich des Lenkers** montierbar

Lamp bracket ›QRIR Extender‹

- for mounting of a head light
- can also be used in combination with the clamp of the handlebar cockpit (art. 390637) for mounting at the **Ø 22.2 mm clamp area of the handlebar**



Art. 390637 + 390638

ART.-NR. BESCHREIBUNG
UVP

DESCRIPTION

244698 LENKERHALTER
›DAVENPORT ARM‹

40,90 €



- Positionierung vor dem Lenker für **bessere Ablesbarkeit** und **zusätzlichen Platz** am Lenker
- universell passend für **Garmin Edge** Serie und **Garmin Forerunner** Serie (Schnellwechselkit nicht enthalten, kein original Garmin Ersatzteil)
- sehr **stabil** und **passgenau** durch **CNC-gefrästes Aluminium**
- für Lenkerdurchmesser **22,2 - 31,8 mm**
- Länge einstellbar
- auf M-Wave Eurolochkarte

HANDLEBAR BRACKET
›DAVENPORT ARM‹

- positioning in front of the handlebar for better **readability** and **more space** at the handlebar
- universally suitable for **Garmin Edge** series and **Garmin Forerunner** series (quick change kit not included, no original Garmin spare part)
- very **stable** and **accurately fitting** by **CNC machined aluminium**
- for **22.2 - 31.8 mm** handlebar diameter
- length adjustable
- on M-Wave eurohole card



244691 AHEADKAPPEN-HALTERUNG
›DAVENPORT AHEAD‹

10,90 €

- zur **Gabelschaft- / Ahead-Montage** (1 1/8")
- universell passend für Garmin, ... (kein original Garmin, ... Ersatzteil)
- auf M-Wave Eurolochkarte

AHEAD CAP BRACKET
›DAVENPORT AHEAD‹

- for **steerer / ahead-cap mount** (1 1/8")
- universally suitable for Garmin, ... (no original Garmin, ... spare part)
- on M-Wave eurohole card



244690 UNIVERSELLE ADAPTERPLATTE
›DAVENPORT PLUG‹

6,90 €

- zur **Befestigung von Mobiltelefonen, Navigationsgeräten, ... auf Garmin-Halterungen** (kein original Garmin Ersatzteil)
- mit **3M** Klebepad und Sicherheits-schrauben
- **Hand- und Sicherheitsschlaufe** verhindert unbeabsichtigtes Herunterfallen des Gerätes
- auf M-Wave Eurolochkarte

UNIVERSAL ADAPTER PLATE
›DAVENPORT PLUG‹

- for **mounting of mobile phones, navigation devices, ... to Garmin mounts** (no original Garmin spare part)
- with **3M** glue pad and safety screws
- **hand and safety sling** prevents the device from accidentally falling
- on M-Wave eurohole card



ART.-NR. UVP **BESCHREIBUNG**

DESCRIPTION

SÄTTEL VON M-WAVE

Hervorragende Qualität zum kleinen Preis!

Mit unserer Sattelkollektion von M-Wave ist es uns gelungen, Ihnen Sättel mit **technischen Finessen** und einer Ausstattung anzubieten, wie dies bisher nur in höheren Preislagen möglich war. Dies gilt sowohl für das **Design** als auch für **funktionelle Ausstattungsmerkmale**, wie verschiedene **Druckentlastungssysteme, Luftstromkühlung** und **Abriebschutz**. Eine **sehr gute Verarbeitung** ist selbstverständlich.

SADDLES MADE BY M-WAVE

Excellent quality for a small price!

With our M-Wave saddle collection we managed to offer you saddles with **technical finesse** and specs that have only been possible in higher price levels so far. This applies for their **design** as well as **functional details** like several **pressure relief systems, air channel cooling** or **rub-off protection**. A **very good finish** is self-evident.



M-WAVE



COMPETITION

COMPETITION

251010 SATTEL ›SPIDER‹

23,90 €

- **W-B-W-Gestell mit Skala**
- **V-Design**
- „**Full Cut**“
- mit **Abriebschutz rechts und links**
- nur **312 g**
- L = 280 x B = 144 mm

SADDLE ›SPIDER‹

- **W-B-W rails with scale**
- **V-Design**
- "**Full Cut**"
- with **abrasion protection right and left**
- only **312 g**
- L = 280 x W = 144 mm



251038 SATTEL ›COMP XI‹

18,90 €

NYLON

- **stabile Nylon-Schale**
- **CrMo-Gestell mit Skala**
- „**Full Cut**“
- **wasserdicht durch Vakuum-Technologie** (verschweißte, wasserdichte und nahtlose Oberfläche)
- nur **282 g**
- L = 255 x B = 145 mm

SADDLE ›COMP XI‹

- **stable nylon base**
- **CrMo rails with scale**
- "**Full Cut**"
- **waterproof because of vacuum technology** (welded, waterproof and seamless surface)
- only **282 g**
- L = 255 x W = 145 mm



251030 SATTEL ›FRITZ‹





17,90 €

- **Aluminium-Look-Gestell mit Skala**
- nur **282 g**
- L = 298 x B = 130 mm

SADDLE ›FRITZ‹

- **aluminium look rails with scale**
- only **282 g**
- L = 298 x W = 130 mm



ART.-NR. UVP	BESCHREIBUNG	DESCRIPTION	
<p>251011 12,90 €</p>	<p>SATTEL ›COMP II›</p> <ul style="list-style-type: none"> • Aluminium-Look-Gestell mit Skala • V-Design • "Base Cut" • nur 265 g • L = 268 x B = 134 mm 	<p>SADDLE ›COMP II‹</p> <ul style="list-style-type: none"> • aluminium look rails with scale • V-Design • "Base Cut" • only 265 g • L = 268 x W = 134 mm 	
<p>250155 12,90 €</p>	<p>SATTEL ›COMP V‹</p> <ul style="list-style-type: none"> • Gestell mit Skala • „Full-Cut“ • nur 297 g • L = 270 x B = 140 mm 	<p>SADDLE ›COMP V‹</p> <ul style="list-style-type: none"> • rails with scale • „Full-Cut“ • only 297 g • L = 270 x W = 140 mm 	
<p>251015 14,90 €</p>	<p>SATTEL ›COMP IV‹</p> <ul style="list-style-type: none"> • Aluminium-Look-Gestell mit Skala • V-Design • hinterer und seitlicher Abriebschutz • nur 336 g • L = 270 x B = 155 mm 	<p>SADDLE ›COMP IV‹</p> <ul style="list-style-type: none"> • aluminium look rails with scale • V-Design • rear and side abrasion protection • only 336 g • L = 270 x W = 155 mm 	
<p>251013 13,90 €</p>	<p>SATTEL ›COMP VI‹</p> <ul style="list-style-type: none"> • Aluminium-Look-Gestell mit Skala • V-Design • "Full-Cut" • besonders hochwertige und stabile Sattelschale • nur 347 g • L = 270 x B = 152 mm 	<p>SADDLE ›COMP VI‹</p> <ul style="list-style-type: none"> • aluminium look rails with scale • V-Design • "Full-Cut" • stable base of high quality • only 347 g • L = 270 x W = 152 mm 	

ART.-NR. BESCHREIBUNG
UVP

DESCRIPTION

251012 SATTEL ›COMP X‹

- 11,90 €
- Aluminium-Look-Gestell mit **Skala**
 - **V-Design**
 - **"Full-Cut"**
 - nur 286 g
 - L = 270 x B = 139 mm

SADDLE ›COMP X‹

- **aluminium look rails with scale**
- **V-Design**
- **"Full-Cut"**
- only 286 g
- L = 270 x W = 139 mm



TOUR

TOUR

251016 SATTEL ›TOUR II‹

- 14,90 €
- Gestell mit **Skala**
 - **"Full-Cut"**
 - mit **"Deep Channel"** Luftkühlung
 - hinterer und seitlicher **Abriebschutz**
 - nur 391 g
 - L = 262 x B = 156 mm



SADDLE ›TOUR II‹

- rails with **scale**
- **"Full-Cut"**
- with **"Deep Channel"** air cooling
- rear and side **abrasion protection**
- only 391 g
- L = 262 x W = 156 mm



SATTEL ›VACU TOUR IV‹

- Gestell mit **Skala**
- **"Full-Cut"**
- **gefederter Stützpunkt**
- mit **Luftkanal** hinten
- L = 260 x B = 186 mm

SADDLE ›VACU TOUR IV‹

- rails with **scale**
- **"Full-Cut"**
- **rail suspension**
- with rear **air channel**
- L = 260 x W = 186 mm



251019

- 18,90 €
- schwarz
 - besonders **weicher Vakuum-Sattel** mit nahtloser Oberfläche
 - nur 451 g

- black
- extra **soft vacuum saddle** with seamless cover
- only 451 g

251020

- 18,90 €
- braun
 - mit hinterem Abriebschutz
 - nur 440 g

- brown
- rear abrasion protection
- only 440 g



ART.-NR. BESCHREIBUNG
UVP

DESCRIPTION

CITY

CITY

CITY

251037 SATTEL ›VACU CITY II‹

16,90 €

VACUUM

- schwarzes Gestell mit **Skala**
- **wasserdicht durch Vakuum-Technologie** (verschweißte, wasserdichte und nahtlose Oberfläche)
- nur 464 g
- L = 260 x B = 210 mm

SADDLE ›VACU CITY II‹

- black rails with **scale**
- **waterproof** because of **vacuum technology** (welded, waterproof and seamless surface)
- only 464 g
- L = 260 x W = 210 mm



VACUUM

SATTEL ›VACU CITY‹

- schwarzes Gestell mit **Skala**
- **wasserdicht durch Vakuum-Technologie** (verschweißte, wasserdichte und nahtlose Oberfläche)

SADDLE ›VACU CITY‹

- black rails with **scale**
- **waterproof** because of **vacuum technology** (welded, waterproof and seamless surface)



251029 Größe S

11,90 €

S

- nur 329 g
- L = 275 x B = 156 mm

size S

- only 329 g
- L = 275 x W = 156 mm

251071 Größe M

13,90 €

M

- nur 389 g
- L = 265 x B = 165 mm

size M

- only 389 g
- L = 265 x W = 165 mm



251039 Größe L

14,90 €

L

- nur 415 g
- L = 268 x B = 190 mm

size L

- only 415 g
- L = 268 x W = 190 mm



251028 Größe XL

15,90 €

XL

- nur 459 g
- L = 257 x B = 211 mm

size XL

- only 459 g
- L = 257 x W = 211 mm



ART.-NR. BESCHREIBUNG
UVP

DESCRIPTION

251072 Größe XL
 • mit **Griff**
 • nur 509 g
 • L = 254 x B = 209 mm

size XL
 • with **handle**
 • only 509 g
 • L = 254 x W = 209 mm

XL



251051 Größe XL
 • mit **Elastomer-Federung**
 • nur 698 g
 • L = 261 x B = 223 mm

size XL
 • with **elastomer suspension**
 • only 698 g
 • L = 261 x W = 223 mm

XL



251073 Größe XL
 • mit **Elastomer-Federung**
 • nur 709 g
 • L = 253 x B = 221 mm

size XL
 • with **elastomer suspension**
 • only 709 g
 • L = 253 x W = 221 mm

XL



251023 SATTEL ›ELAST XXL CITY‹
 • schwarzes Gestell mit **Skala**
 • mit **Elastomer-Federung**
 • hinterer und seitlicher **Abriebschutz**
 • mit **Sattelstützklemme**
 • nur 986 g
 • L = 291 x B = 276 mm

SADDLE ›ELAST XXL CITY‹
 • black rails with **scale**
 • with **elastomer suspension**
 • rear and side **abrasion protection**
 • with **clamp** for seat post
 • only 986 g
 • L = 291 x W = 276 mm

XXL

120 kg



X-TRA WIDE

ART.-NR. UVP	BESCHREIBUNG	DESCRIPTION	
<p>251034 Größe M L = 260 mm x B = 185 mm</p> <p>M</p> <p>251027 Größe L L = 265 mm x B = 200 mm 22,90 €</p> <p>L</p>	<p>SATTEL ›ELAST CITY‹</p> <ul style="list-style-type: none"> • Elastomer-Federung • vorderer und hinterer Abriebschutz • schwarzes Gestell mit Skala 	<p>SADDLE ›ELAST CITY‹</p> <ul style="list-style-type: none"> • elastomer suspension • front and rear abrasion protection • black rails with scale <p>size M L = 260 mm x W = 185 mm</p> <p>size L L = 265 mm x W = 200 mm</p>	
<p>251022 Größe L L = 265 mm x B = 200 mm 22,90 €</p> <p>L</p>	<p>braune Echtlederoptik</p>	<p>brown genuine leather appearance</p> <p>size L L = 265 mm x W = 200 mm</p>	
<p>251060 SATTEL ›EVA CITY‹ 17,90 €</p>	<p>SATTEL ›EVA CITY‹</p> <ul style="list-style-type: none"> • sehr weicher EVA-Sattel • sehr umweltfreundliches Obermaterial • robuste Oberfläche • nur 448 g • L = 262 x B = 216 mm 	<p>SADDLE ›EVA CITY‹</p> <ul style="list-style-type: none"> • very soft EVA-saddle • very environmentally friendly upper material • robust surface • only 448 g • L = 262 x W = 216 mm 	
<p>251021 SATTEL ›CITY SPRING‹ 13,90 €</p>	<p>SATTEL ›CITY SPRING‹</p> <ul style="list-style-type: none"> • schwarzes Gestell • mit Federn • mit Sattelstützklemme • nur 625 g • L = 235 x B = 205 mm 	<p>SADDLE ›CITY SPRING‹</p> <ul style="list-style-type: none"> • black rails • with springs • with clamp for seat post • only 625 g • L = 235 x W = 205 mm 	

ART.-NR. BESCHREIBUNG
UVP

DESCRIPTION

YOUTH / CHILD

YOUTH / CHILD

251049 SATTEL ›TEEN TWO‹

- 11,90 € • für 24" (20" - 26")
- "Base Cut"
- vorderer und hinterer Abriebschutz
- mit **Sattelstützklemme**
- nur **493 g**
- L = 242 x B = 143 mm

SADDLE ›TEEN TWO‹

- for 24" (20" - 26")
- "Base Cut"
- front and rear abrasion protection
- with **clamp for seat post**
- only **493 g**
- L = 242 x W = 143 mm



251025 SATTEL ›TEEN‹

- 10,90 € • für 20" (16" - 24")
- mit **Sattelstützklemme**
- nur 433 g
- L = 216 x B = 168 mm

SADDLE ›TEEN‹

- for 20" (16" - 24")
- with **clamp for seat post**
- only 433 g
- L = 216 x W = 168 mm



251032 SATTEL ›KID GRIP‹

- 8,90 € • für 12" - 16"
- **integrierter Trage- und Haltegriff**
- mit **Sattelstützklemme**
- **360° Abriebschutz**
- nur 398 g
- L = 207 x B = 135 mm

SADDLE ›KID GRIP‹

- for 12" - 16"
- **integrated handle** for carrying
- with **clamp for seat post**
- **360° abrasion protection**
- only 398 g
- L = 207 x W = 135 mm



Tested by the manufacturer according to ISO 4210

Saddles & Saddle Covers



ART.-NR. UVP	BESCHREIBUNG	DESCRIPTION	
	GEL-SATTELDECKEN ›ANATOMIC‹	GEL SADDLE COVERS ›ANATOMIC‹	
	<ul style="list-style-type: none"> • sehr bequeme Satteldecken • anatomisch geformte Geleinlage • mit Spannschnur • auf M-Wave Eurolochkarte 	<ul style="list-style-type: none"> • very comfortable saddle covers • anatomic formed GEL-inlay • with tensioning cord • on M-Wave eurohole card 	
137600	für MTB-, Touring- und Rennradsättel	for MTB, touring and racing saddles	
9,90 €			
137601	breite Ausführung	big version	
12,90 €			
	SATTELDECKE ›URBAN‹	SADDLE COVER ›URBAN‹	
6,90 €	<ul style="list-style-type: none"> • 20 mm Schaumstoffeinlage • schwarz mit reflektierenden Seiten • durch Zugkordel für alle Größen anpassbar • auf M-Wave Eurolochkarte 	<ul style="list-style-type: none"> • 20 mm foam pad • black with reflective sideparts • adjustable by drawstring for all sizes • on M-Wave eurohole card 	
			
	SATTELDECKE ›FASHION‹	SADDLE COVER ›FASHION‹	
	<ul style="list-style-type: none"> • Universalgröße • 10 mm Schaumstoffeinlage, eingenäht • mit Zugkordel • auf M-Wave Eurolochkarte 	<ul style="list-style-type: none"> • universal size • 10 mm foam pad, sewn-in • with cord and stopper • on M-Wave eurohole card 	   
137920	›Sunflower‹	›Sunflower‹	
137921	›Newspaper‹	›Newspaper‹	
137922	›Ladybird‹	›Ladybird‹	
137930	›Smile‹	›Smile‹	
4,90 €			
	Weitere Motive auf Anfrage.	More motives on request.	
	SATTELKLEMME MIT GEPÄCKTRÄGERBEFESTIGUNG ›RACKY‹	SEAT TUBE CLAMP WITH LUGGAGE CARRIER FIXATION ›RACKY‹	
	<ul style="list-style-type: none"> • Aluminium • nur 36 g (Ø 31,8 mm) • mit Gewindeösen für die Gepäckträgerbefestigung • auf M-Wave Eurolochkarte 	<ul style="list-style-type: none"> • aluminium • only 36 g (Ø 31.8 mm) • with threads for luggage carrier fixation • on M-Wave eurohole card 	
250848	Ø 28,6 mm	Ø 28.6 mm	
250850	Ø 31,8 mm	Ø 31.8 mm	
250851	Ø 34,9 mm	Ø 34.9 mm	
8,90 €			

ART.-NR. UVP	BESCHREIBUNG	DESCRIPTION
-----------------	--------------	-------------

SATTELKLEMME ›CLAMPY QR‹

- mit **Schnellspanner**
- Aluminium
- auf **M-Wave Eurolochkarte**

Ø 31,8 mm

250986 schwarz eloxiert

250988 silber eloxiert

Ø 34,9 mm

250987 schwarz eloxiert

250941 silber eloxiert

4,90 €

SEAT TUBE CLAMP ›CLAMPY QR‹

- with **QR**
- aluminium
- on **M-Wave eurohole card**

Ø 31.8 mm

black anodised

silver anodised

Ø 34.9 mm

black anodised

silver anodised



SATTELKLEMME ›CLAMPY‹

- Aluminium
- auf **M-Wave Eurolochkarte**

Ø 31,8 mm

250938 schwarz eloxiert

Ø 34,9 mm

250960 schwarz eloxiert

250961 silber eloxiert

3,90 €

SEAT TUBE CLAMP ›CLAMPY‹

- aluminium
- aluminium
- on **M-Wave eurohole card**

Ø 31.8 mm

black anodised

Ø 34.9 mm

black anodised

silver anodised



GEFEDERTE SATTELSTÜTZEN

HÖHENVERSTELLBARE SATTELSTÜTZE ›LEVITATE C‹

- Aluminium
- **pneumatische Schnellhöhenverstellung** während der Fahrt durch einen **Hebel am Lenker**
- **leichtgängige, stufenlose Höhenverstellung**
- mit Skala
- Fahrergewicht bis **120 kg**
- in M-Wave Eurolochbox

252230 • Ø 27,2 mm
• Länge: 390 mm
• Höhenverstellung: **0 - 105 mm**

• Länge: 400 mm
• Höhenverstellung: **0 - 125 mm**

252231 Ø 30,9 mm

252232 Ø 31,6 mm

245,00 €

DROPPER SEAT POST ›LEVITATE C‹

- aluminium
- **pneumatic quick release height adjustment** while riding by a **handlebar lever**
- **easy going, stepless height adjustment**
- with scale
- rider's weight up to **120 kg**
- in M-Wave eurohole box

• Ø 27.2 mm
• length: 390 mm
• height adjustment: **0 - 105 mm**

• length: 400 mm
• height adjustment: **0 - 125 mm**

Ø 30.9 mm



Ø 31.6 mm

SUSPENSION SEAT POSTS



Tested by the manufacturer based on ISO 4210

ART.-NR. UVP	BESCHREIBUNG	DESCRIPTION	
	HÖHENVERSTELLBARE SATTELSTÜTZE ›LEVITATE IN 125‹ <ul style="list-style-type: none"> • aufgeräumte Zugverlegung durch integrierte Kabelführung • Aluminium • pneumatische, stufenlose Schnellhöhenverstellung während der Fahrt durch einen Hebel am Lenker • mit Skala • Länge 420 mm • Höhenverstellung 0 - 125 mm • in M-Wave Eurolochbox 	DROPPER SEAT POST ›LEVITATE IN 125‹ <ul style="list-style-type: none"> • clean look through integrated cable routing • aluminium • pneumatic quick release, stepless height adjustment while riding by a handlebar lever • with scale • length 420 mm • height adjustment 0 - 125 mm • in M-Wave eurohole box 	
252200	Ø 30,9 mm	Ø 30.9 mm	
252202	Ø 31,6 mm	Ø 31.6 mm	
	266,90 €		

	HÖHENVERSTELLBARE SATTELSTÜTZE ›LEVITATE IN LT‹ <ul style="list-style-type: none"> • aufgeräumte Zugverlegung durch integrierte Kabelführung • Aluminium • pneumatische, stufenlose Schnellhöhenverstellung während der Fahrt durch einen Hebel am Lenker, mit Edelstahlkabel • mit Skala 	DROPPER SEAT POST ›LEVITATE IN LT‹ <ul style="list-style-type: none"> • clean look through integrated cable routing • aluminium • pneumatic quick release, stepless height adjustment while riding by a handlebar lever, with stainless steel cable • with scale 	
	<ul style="list-style-type: none"> • Länge 440 mm • Höhenverstellung 0 - 150 mm 	<ul style="list-style-type: none"> • length 440 mm • height adjustment 0 - 150 mm 	
252220	Ø 30,9 mm, in M-Wave Eurolochbox	Ø 30.9 mm, in M-Wave eurohole box	
252222	Ø 31,6 mm, in M-Wave Eurolochbox	Ø 31.6 mm, in M-Wave eurohole box	
252224	Ø 30,9 mm, Montageverpackung	Ø 30.9 mm, OEM	
252226	Ø 31,6 mm, Montageverpackung	Ø 31.6 mm, OEM	
	<ul style="list-style-type: none"> • Länge 480 mm • Höhenverstellung 0 - 170 mm 	<ul style="list-style-type: none"> • length 480 mm • height adjustment 0 - 170 mm 	
252221	Ø 30,9 mm, in M-Wave Eurolochbox	Ø 30.9 mm, in M-Wave eurohole box	
252223	Ø 31,6 mm, in M-Wave Eurolochbox	Ø 31.6 mm, in M-Wave eurohole box	
252225	Ø 30,9 mm, Montageverpackung	Ø 30.9 mm, OEM	
252227	Ø 31,6 mm, Montageverpackung	Ø 31.6 mm, OEM	
	219,00 €		

Tested by the manufacturer based on ISO 4210

ART.-NR. UVP
BESCHREIBUNG

DESCRIPTION

HÖHENVERSTELLBARE SATTELSTÜTZE ›LEVITATE EX 125‹

- Aluminium
- **pneumatische Schnellhöhenverstellung während der Fahrt durch einen Hebel am Lenker**
- **leichtgängige, stufenlose Höhenverstellung: 0 - 125 mm**
- mit Skala
- Fahrergewicht bis **120 kg**
- Länge: 475 mm
- in M-Wave Eurolochbox

DROPPER SEAT POST ›LEVITATE EX 125‹

- aluminium
- **pneumatic quick release height adjustment while riding by a handlebar lever**
- **easy going, stepless height adjustment: 0 - 125 mm**
- with scale
- rider's weight up to **120 kg**
- length: 475 mm
- in M-Wave eurohole box



Tested by the manufacturer based on ISO 4210

252240 Ø 30,9 mm

Ø 30.9 mm

252241 Ø 31,6 mm

Ø 31.6 mm

159,00 €

HÖHENVERSTELLBARE SATTELSTÜTZE ›LEVITATE IN 2‹

- aufgeräumte Zugverlegung durch **integrierte Kabelführung**
- Aluminium
- **hydraulische Schnellhöhenverstellung während der Fahrt durch einen Hebel am Lenker**
- mit Skala
- Montageverpackung

DROPPER SEAT POST ›LEVITATE IN 2‹

- clean look through **integrated cable routing**
- aluminium
- **hydraulic quick release height adjustment while riding by a handlebar lever**
- with scale
- OEM



Tested by the manufacturer based on ISO 4210

252213 • Ø 27,2 mm
• Länge: 373 mm
• Höhenverstellung: **0 - 100 mm**

• Ø 27.2 mm
• length: 373 mm
• height adjustment: **0 - 100 mm**

• Länge: 426 mm
• Höhenverstellung: **0 - 125 mm**

• length: 426 mm
• height adjustment: **0 - 125 mm**

252214 Ø 30,9 mm

Ø 30.9 mm

252215 Ø 31,6 mm

Ø 31.6 mm

136,00 €

HÖHENVERSTELLBARE SATTELSTÜTZE ›SP110-ADJ‹

- Aluminium
- **Schnellhöhenverstellung während der Fahrt durch Hebel am Lenker**
- **3 Höhenstufen: 0/45/110 mm**
- Länge 445 mm
- mit Skala

DROPPER SEAT POST ›SP110-ADJ‹

- aluminium
- **quick release hight adjustment while riding by a handlebar lever**
- **3 height steps: 0/45/110 mm**
- length 445 mm
- with scale



auf **M-Wave Eurolochkarte**

on **M-Wave eurohole card**

252147 Ø 27,2 mm

Ø 27.2 mm

252155 Ø 31,6 mm

Ø 31.6 mm

Montageverpackung

OEM

252148 Ø 27,2 mm

Ø 27.2 mm

252156 Ø 31,6 mm

Ø 31.6 mm

129,00 €

ART.-NR. UVP	BESCHREIBUNG	DESCRIPTION
	GEFEDERTE PARALLELOGRAMMSATTELSTÜTZE ›FOURSPRING‹ <ul style="list-style-type: none"> • einteiliges Aluminiumrohr mit Design-Schutzabdeckung • hervorragendes Ansprechverhalten durch Parallelogrammverschiebung (kein Verkanten) • Vorspannung einstellbar • 2-Punkt Befestigung des Sattelgestells, mit Winkelskala • Federweg: 36 mm im Kreisbogen • Länge 350 mm • mit Skala (Höheneinstellung) • mit Originalfeder empfohlen bis 85 kg • optional durch Austausch-Federn (Art. 252178, 252165, 252179) für anderes Fahrergewicht anpassbar 	PARALLELOGRAM SUSPENSION SEAT POST ›FOURSPRING‹ <ul style="list-style-type: none"> • one-piece aluminium tube with design protective cover • very sensitive response characteristic through parallelogram movement (no tilting) • preload adjustable • 2-point fixation of the saddle rails, with angular scale • travel: 36 mm in a circular arc • length 350 mm • with scale (height adjustment) • with original replacement springs recommended up to 85 kg • optionally convertible to another driver's weight by replacement springs (art. 252178, 252165, 252179)
	auf M-Wave Eurolochkarte	on M-Wave eurohole card
252176	Ø 27,2 mm	Ø 27.2 mm
252197	Ø 30,9 mm	Ø 30.9 mm
252177	Ø 31,6 mm	Ø 31.6 mm
	Montageverpackung	OEM
252180	Ø 27,2 mm	Ø 27.2 mm
252182	Ø 30,9 mm	Ø 30.9 mm
252181	Ø 31,6 mm	Ø 31.6 mm
133,00 €		



ART.-NR.	ERSATZ-/TUNING-FEDER	REPLACEMENT-/TUNING-SPRING
	<ul style="list-style-type: none"> • zum Umbau der Sattelstützen Art. 252180-2 für ein anderes Fahrergewicht • im Polybeutel mit Aufkleber 	<ul style="list-style-type: none"> • for converting seat post art. 252180-2 to another rider's weight • in PE bag with sticker
252178	0 - 70 kg, silber	0 - 70 kg, silver
252165	85 - 100 kg, schwarz	85 - 100 kg, black
252179	100 - 120 kg, grün	100 - 120 kg, green
8,90 €		



ART.-NR. UVP
BESCHREIBUNG

DESCRIPTION



PARALLELOGRAMM-SATTELSTÜTZE ›FOURSPRING VARIO‹

- **einteiliges Aluminiumrohr**
- **hervorragendes Ansprechverhalten** durch Parallelogrammverschiebung (kein Verkanten)
- **schnelle und einfache De-/Montage des Sattels**
- Vorspannung einstellbar
- Federweg 20 mm im Kreisbogen
- Länge 350 mm
- mit Skala
- für Fahrergewicht **70 bis 90 kg** empfohlen
- optional durch Austausch-Federn (Art. 252187, 252199) für anderes Fahrergewicht anpassbar

PARALLELOGRAM SEAT POST ›FOURSPRING VARIO‹

- **one-piece aluminium tube**
- **very sensitive response characteristic** through parallelogram movement (no tilting)
- **quick and easy dismantling and assembly of the saddle**
- preload adjustable
- circular travel 20 mm
- length 350 mm
- with scale
- recommended for drivers weight **70 to 90 kg**
- optionally convertible to another driver's weight by replacement springs (art. 252187, 252199)



auf M-Wave Eurolochkarte

on M-Wave Eurohole card

252183	Ø 27,2 mm
252196	Ø 30,9 mm
252184	Ø 31,6 mm

Ø 27.2 mm
Ø 30.9 mm
Ø 31.6 mm

Montageverpackung

OEM

252185	Ø 27,2 mm
252194	Ø 30,9 mm
252186	Ø 31,6 mm

Ø 27.2 mm
Ø 30.9 mm
Ø 31.6 mm

99,90 €

Tested by the manufacturer based on ISO 4210

0-120 kg

ERSATZ-/TUNING-FEDER

zum Umbau der Sattelstützen Art. 252185/86/94, 252183/84/96 für ein anderes Fahrergewicht

REPLACEMENT-/ TUNING-SPRING

for converting seat post art. 252185/ 86/94, 252183/84/96 to another rider's weight

252187 50 - 90 kg, silber

50 - 90 kg, silver

252199 90 - 120 kg, schwarz

90 - 120 kg, black

5,90 €



252198 NEOPRENSCHUTZCOVER FÜR PARALLELOGRAM-SATTELSTÜTZEN ›FOURSPRING COVER‹

7,90 €

- **schützt vor eingeklemmten Fingern, Witterungsschäden und Schmutz**
- mit **universellem Klettverschluss**
- mit **reflektierendem Material**
- passend für Art. 252183 ff., ...
- auf M-Wave Eurolochkarte

NEOPRENE PROTECTION COVER FOR PARALLELOGRAM SEAT-POSTS ›FOURSPRING COVER‹

- **protects from pinched fingers, weather damage and dirt**
- with **universal hook and loop fastener**
- with **reflective material**
- suitable for art. 252183 et seq., ...
- on M-Wave eurole card



ART.-NR. UVP	BESCHREIBUNG	DESCRIPTION	
	GEFEDERTE SATTELSTÜTZE ›SP-C3‹ <ul style="list-style-type: none"> • Aluminium • Spiel einstellbar • Länge 350 mm • Federweg 40 mm • Offset: 8 mm • Vorspannung einstellbar • mit Skala <p>auf M-Wave Eurolochkarte</p> <p>252324 Ø 27,2 mm</p> <p>252325 Ø 30,9 mm</p> <p>252326 Ø 31,6 mm</p> <p>Montageverpackung</p> <p>252327 Ø 27,2 mm</p> <p>252328 Ø 30,9 mm</p> <p>252329 Ø 31,6 mm</p> <p>27,90 €</p>	SUSPENSION SEAT POST ›SP-C3‹ <ul style="list-style-type: none"> • aluminium • tolerance adjustable • length 350 mm • 40 mm travel • offset: 8 mm • preload adjustable • with scale <p>on M-Wave eurohole card</p> <p>Ø 27.2 mm</p> <p>Ø 30.9 mm</p> <p>Ø 31.6 mm</p> <p>OEM</p> <p>Ø 27.2 mm</p> <p>Ø 30.9 mm</p> <p>Ø 31.6 mm</p> <p>Tested by the manufacturer based on ISO 4210</p>	
	GEFEDERTE SATTELSTÜTZE <ul style="list-style-type: none"> • Aluminium • Länge 315 mm • Federweg 40 mm • Vorspannung einstellbar • Montageverpackung <p>252122 Ø 25,4 mm</p> <p>252123 Ø 27,2 mm</p> <p>14,90 €</p>	SUSPENSION SEAT POST <ul style="list-style-type: none"> • aluminium • length 315 mm • 40 mm travel • preload adjustable • OEM <p>Ø 25.4 mm</p> <p>Ø 27.2 mm</p>	
	GEFEDERTE SATTELSTÜTZE <ul style="list-style-type: none"> • Aluminium • Federweg 40 mm • Vorspannung einstellbar • Montageverpackung <p>Länge 315 mm</p> <p>252115 Ø 25,4 mm</p> <p>252116 Ø 27,2 mm</p> <p>Länge 300 mm, ohne Logo</p> <p>252129 Ø 27,2 mm</p> <p>15,90 €</p>	SUSPENSION SEAT POST <ul style="list-style-type: none"> • aluminium • 40 mm travel • preload adjustable • OEM <p>length 315 mm</p> <p>Ø 25.4 mm</p> <p>Ø 27.2 mm</p> <p>length 300 mm, without logo</p> <p>Ø 27.2 mm</p>	
	GEFEDERTE KERZEN-SATTELSTÜTZE <ul style="list-style-type: none"> • Aluminium • Vorspannung einstellbar • Länge 300 mm • Federweg 40 mm • Montageverpackung <p>252058 Ø 25,4 mm</p> <p>252059 Ø 27,2 mm</p> <p>11,90 €</p>	SUSPENSION SEAT POST <ul style="list-style-type: none"> • aluminium • preload adjustable • length 300 mm • 40 mm travel • OEM <p>Ø 25.4 mm</p> <p>Ø 27.2 mm</p>	

ART.-NR. UVP **BESCHREIBUNG**

DESCRIPTION

252195 SATTELSTÜTZE ›RAPID SWAP‹

24,90 €



- **schneller Sattelwechsel** durch **Schnellspanner**
- ideal **zum Testen verschiedener Sättel**, Verleihräder, ...
- Aluminium
- Länge 350 mm
- Ø 27,2 mm (Adapter für andere Durchmesser auf Seite 156)
- auf M-Wave Eurolochkarte

SEAT POST ›RAPID SWAP‹

- **quick saddle change** by **QR**
- ideal for **testing of various saddles**, rental bikes, ...
- aluminium
- length 350 mm
- Ø 27.2 mm (adapters for various diameters on page 156)
- on M-Wave eurohole card



SATTELSTÜTZE ›A 350 STRONG‹

- mit **Aluminium-Kopf**
- einfache Sattelneigeinstellung durch 2-Schrauben-Einstellsystem
- Offset: 15 mm
- Länge 350 mm

SEAT POST ›A 350 STRONG‹

- with **aluminium head**
- easy saddle angle adjustable with 2 bolts
- offset: 15 mm
- length 350 mm



auf M-Wave Eurolochkarte

on M-Wave eurohole card

- 252831** Ø 27,2 mm
- 252833** Ø 30,9 mm
- 252835** Ø 31,6 mm

Montageverpackung

OEM

- 252830** Ø 27,2 mm
- 252832** Ø 30,9 mm
- 252834** Ø 31,6 mm

15,90 €

SATTELSTÜTZE

- mit **Aluminium-Kopf**
- Länge **350 mm**
- Montageverpackung

SEAT POST

- with **aluminium head**
- length **350 mm**
- OEM

schwarz

black

- 252426** Ø 25,4 mm
- 252427** Ø 27,2 mm
- 252428** Ø 28,6 mm

- Ø 25.4 mm
- Ø 27.2 mm
- Ø 28.6 mm

silber

silver

- 252423** Ø 25,4 mm
- 252425** Ø 27,2 mm

- Ø 25.4 mm
- Ø 27.2 mm

9,90 €



Tested by the manufacturer based on ISO 4210

259891 KINDER-REGENPONCHO ›PONCHO KID´N´SEAT‹

34,90 €

- passend für **alle gängigen Kindersitze**
- geeignet **für Kinder von 6 Monaten bis 5 Jahren**
- mit Ärmeln für optimale Bewegungsfreiheit
- auch zur Abdeckung des Kindersitzes geeignet
- mit reflektierenden Elementen
- im Polybeutel mit Euroloch

RAIN COVER FOR CHILDREN SEAT ›PONCHO KID´N´SEAT‹

- suitable for **all common child seats**
- suitable for **children from 6 months to 5 years**
- with sleeves for optimal freedom of movement
- also useable for covering the baby seat
- with reflective elements
- in PE bag with eurohole



ART.-NR. BESCHREIBUNG
UVP

DESCRIPTION

360°

FAHRRADSPIEGEL

- 3-dimensional verstellbar
- gestochen scharfes, entspiegeltes, schlagfestes und blendfreies Echtglas
- sehr beständiges Gehäuse aus **Nylonfasern**
- Aluminiumschelle Ø 22,2 mm
- sehr leicht, nur ca. **137 g**
- in M-Wave Eurolochbox

BICYCLE MIRROR

- 3-dimensionally adjustable
- high definition, antireflective, blast resistant and glare-free **genuine glass**
- high impact **nylon fiber** frame
- aluminium clamp Ø 22.2 mm
- very light, only approx. **137 g**
- in M-Wave eurohole box



137 g

›SPY SPACE‹

›SPY SPACE‹

270015 zur Montage an der **linken** Seite

for mounting at the **left** side

270016 zur Montage an der **rechten** Seite

for mounting at the **right** side

23,90 €

270019 ›SPY SPACE BAREND‹

›SPY SPACE BAREND‹

26,90 € zur Montage am **linken Lenkerende**

for mounting on **left handlebar end**



141 g

270014 **FAHRRADSPIEGEL**

BICYCLE MIRROR

›SPY SPACE IN XL‹

›SPY SPACE IN XL‹

21,90 €

360°

- 3-dimensional verstellbar
- Montage links
- gestochen scharfes, entspiegeltes, schlagfestes und blendfreies Echtglas
- sehr beständiges Gehäuse aus **Nylonfasern**
- ca. Ø 80 mm Spiegelfläche
- passend für Ø 17-22 mm Lenkerinnendurchmesser
- auf M-Wave Eurolochkarte

- 3-dimensionally adjustable
- left side mounting
- high definition, antireflective, blast resistant and glare-free **genuine glass**
- high impact **nylon fiber** frame
- approx. Ø 80 mm mirror surface
- suitable for Ø 17-22 mm inner bar diameter
- on M-Wave eurohole card



270017 **FAHRRADSPIEGEL**

BICYCLE MIRROR

›SPY SPACE IN‹

›SPY SPACE IN‹

23,90 €

360°

- 3-dimensional verstellbar
- universelle Montage **rechts und links** möglich
- gestochen scharfes, entspiegeltes, schlagfestes und blendfreies Echtglas
- sehr beständiges Gehäuse aus **Nylonfasern**
- sehr stabile Befestigung, teilweise aus **Aluminium**
- für Lenker und Lenkerzusatzgriffe mit Ø 16 – 22 mm Innendurchmesser
- auf M-Wave Eurolochkarte

- 3-dimensionally adjustable
- universal mounting at **left and right side** possible
- high definition, antireflective, blast resistant and glare-free **genuine glass**
- high impact **nylon fiber** frame
- very stable mounting, partially made of **aluminium**
- for handlebars and bar ends with Ø 16 – 22 mm inner diameter
- on M-Wave eurohole card



270071 **FAHRRADSPIEGEL**

BICYCLE MIRROR

›SPY SPACE 45 COMPACT‹

›SPY SPACE 45 COMPACT‹

32,90 €

E

- **ECE geprüft:** für alle Fahrzeuge der Klasse L, die keine den Fahrer umschließende Karosserie aufweisen, z. B. **geeignet für E-Bikes, S-Pedelecs** bis 45 km/h Maximalgeschwindigkeit, **Mofas, Motorräder, Quads, ...**
- 3-dimensional verstellbar
- gestochen scharfes, entspiegeltes, schlagfestes und blendfreies Echtglas
- sehr beständiges Gehäuse aus **Nylonfasern**
- Aluminiumschelle Ø 22,2 mm
- nur 161 g
- in M-Wave Eurolochbox

- **ECE approved:** for all class L vehicles which do not have a bodywork surrounding the driver, e. g. **suitable for E-Bikes, S-Pedelecs** up to 45 km/h maximum speed, **mopeds, motorcycles, quads, ...**
- 3-dimensionally adjustable
- high definition, antireflective, blast resistant and glare-free **genuine glass**
- high impact **nylon fiber** frame
- aluminium clamp Ø 22.2 mm
- only 161 g
- in M-Wave eurohole box



ECE APPROVED

Mirrors

ART.-NR. BESCHREIBUNG
UVP

DESCRIPTION

270070 FAHRRADSPIEGEL
›SPY SPACE 45‹

21,90 €



- **ECE geprüft:** für alle Fahrzeuge der Klasse L, die keine den Fahrer umschließende Karosserie aufweisen, z. B. **geeignet für E-Bikes, S-Pedelecs** bis 45 km/h Maximalgeschwindigkeit, **Mofas, Motorräder, Quads, ...**
- **3-dimensional verstellbar**
- **blendfreies Echtglas**
- zur Montage am Lenkerende links mit Innen-Ø 14,5 - 16,5 mm und Ø 18 - 19,5 mm
- in M-Wave Blisterverpackung

BICYCLE MIRROR
›SPY SPACE 45‹

- **ECE approved:** for all class L vehicles which do not have a bodywork surrounding the driver, e. g. **suitable for E-Bikes, S-Pedelecs** up to 45 km/h maximum speed, **mopeds, motorcycles, quads, ...**
- **3-dimensionally adjustable**
- **glare-free genuine glass**
- for mounting on handlebar ends left side with inner Ø 14.5 - 16.5 mm and Ø 18 - 19.5 mm
- in M-Wave blister packaging



ECE APPROVED

270060 FAHRRADSPIEGEL
›SPY FLEX‹

12,90 €



- **mit flexiblem Schwanenhals** zum schnellen Drehen oder Verstellen
- **3-dimensional verstellbarer Konvexspiegel**
- Gesamtlänge ca. 315 mm
- ca. Ø 70 mm Spiegelfläche
- Klemmschelle Ø 21 - 30 mm
- auf M-Wave Eurolochkarte

BICYCLE MIRROR
›SPY FLEX‹

- **with flexible rod** for quick turning or adjustment
- **3-dimensionally adjustable convex mirror**
- total length approx. 315 mm
- approx. Ø 70 mm mirror surface
- clamp Ø 21 - 30 mm
- on M-Wave eurohole card



270061 FAHRRADSPIEGEL
›SPY FLEX TF‹

11,90 €



- **mit flexiblem Schwanenhals** zum schnellen Drehen oder Verstellen
- **3-dimensional verstellbarer Konvexspiegel**
- Gesamtlänge ca. 375 mm
- ca. Ø 80 mm Spiegelfläche
- **werkzeuglose Montage** mit Ø 21 - 30 mm Klemme
- auf M-Wave Eurolochkarte

BICYCLE MIRROR
›SPY FLEX TF‹

- **with flexible rod** for quick turning or adjustment
- **3-dimensionally adjustable convex mirror**
- total length approx. 375 mm
- approx. Ø 80 mm mirror surface
- **toolless mounting** with clamp for Ø 21 - 30 mm
- on M-Wave eurohole card



270080 FAHRRADSPIEGEL
›SPY BASE‹

10,90 €



- **3-dimensional verstellbar**
- variable Einstellmöglichkeiten
- **konvexe und blendfreie** Spiegelfläche (ca. 105 x 70 mm)
- **superleicht**, nur **99 g**
- Klemmschelle Ø 22,2 mm, ohne Demontage von Griff, ... montierbar
- Länge: ca. 300 mm
- auf M-Wave Eurolochkarte

BICYCLE MIRROR
›SPY BASE‹

- **3-dimensionally adjustable**
- variable adjustment possibilities
- **convex and glare-free** mirror surface (approx. 105 x 70 mm)
- **super light**, only **99 g**
- clamp Ø 22.2 mm, mountable without demounting of grip, ...
- length: approx. 300 mm
- on M-Wave eurohole card



ART.-NR. UVP
BESCHREIBUNG

DESCRIPTION

360°

FAHRRADSPIEGEL

- universeller, **3-dimensional verstellbarer Konvexspiegel**
- ca. Ø 46 mm
- **universeller** Gummizughalter zur **werkzeuglosen Montage** am Lenker, Vorbau, Lenkerzusatzgriff, Rahmen, ...
- auf M-Wave Eurolochkarte



BICYCLE MIRROR

- universal, **3-dimensionally adjustable convex mirror**
- approx. Ø 46 mm
- **universal** rubber bracket for **toolless mounting** on handlebar, handle stem, bar end, frame, ...
- on M-Wave eurohole card



270028 ›SPY MINI‹

8,90 €

›SPY MINI‹

270034 ›SPY MINI SHORT‹

7,90 €

›SPY MINI SHORT‹



270020 **FAHRRADSPIEGEL** ›SPY MAXI‹

7,90 €

360°

- **3-dimensional verstellbarer Konvexspiegel**
- ca. Ø 76 mm
- für Montage am Lenkerende oder Lenkerzusatzgriff
- auf M-Wave Eurolochkarte

BICYCLE MIRROR ›SPY MAXI‹

- **3-dimensionally adjustable convex mirror**
- approx. Ø 76 mm
- for mounting on handlebar end or bar end
- on M-Wave eurohole card



270029 **FAHRRADSPIEGEL** ›SPY MICRO‹

7,90 €

360°

- universeller, **3-dimensional verstellbarer Konvexspiegel**
- ca. Ø 35 mm
- für Montage am Lenkerende oder Lenkerzusatzgriff
- **werkzeuglos montierbar**
- schwarz
- auf M-Wave Eurolochkarte



BICYCLE MIRROR ›SPY MICRO‹

- universal, **3-dimensionally adjustable convex mirror**
- approx. Ø 35 mm
- for mounting on handlebar end or bar end
- **toolless mounting**
- black
- on M-Wave eurohole card



270032 **FAHRRADSPIEGEL** ›SPY OVAL‹

5,90 €

360°

- **3-dimensional** verstellbar
- für **werkzeuglose Montage** am Lenkerende oder Lenkerzusatzgriff
- mit **2 Haltern** für unterschiedliche Lenkerdurchmesser
- ca. 75 x 50 mm
- schwarz
- auf M-Wave Eurolochkarte



BICYCLE MIRROR ›SPY OVAL‹

- **3-dimensionally** adjustable
- for **toolless mounting** on handlebar end or bar end
- with **2 holders** for different handlebar diameters
- approx. 75 x 50 mm
- black
- on M-Wave eurohole card



ART.-NR. **BESCHREIBUNG**
UVP

DESCRIPTION

M-WAVE E-BIKE KETTEN

Mit den E-Bike Ketten für 1-11-fach Systeme schafft es M-Wave haltbare und bezahlbare Ketten zu realisieren.

Natürlich sind sie für alle gängigen E-Motoren geeignet.

Auch im Programm: ein komplettes Sortiment von Antirost-Ketten, die für alle Schaltsysteme von Singlespeed bis 11-fach passen.

M-WAVE E-BIKE CHAINS

With the e-bike chains for 1-11 speed systems M-Wave manages to create durable and affordable e-bike chains.

Of course, they are suitable for all common e-bike engines.

Also in the assortment: a complete range of anti rust chains that fit all gear systems from single speed to 11 speed.



›ELEVENSPEED‹

- für **11-fach** Schaltungssysteme
- 1/2" x 11/128"
- 116 Glieder
- mit Verschlussglied
- im M-Wave Einzelkarton

301941

›Elevenspeed E‹

41,90 €

- besonders geeignet für **E-Bikes**
- **längere Haltbarkeit** durch Verstärkungen
- für **Brose, Bosch, Shimano, Bafang, ...** Antriebe
- grau

301911

›Elevenspeed AR‹

39,90 €

- mit **Antirost-Beschichtung**
- kompatibel zu **Shimano / Sram / Campagnolo**
- silber

301906

›Elevenspeed‹

26,90 €

- kompatibel zu **Shimano / Sram / Campagnolo**
- dunkelgrau

›ELEVENSPEED‹

- for **11 speed**
- 1/2" x 11/128"
- 116 links
- with connecting link
- in M-Wave box

›Elevenspeed E‹

- particularly suitable for **e-bikes**
- **longer durability** due to reinforcements
- for **Brose, Bosch, Shimano, Bafang, ...** drives
- grey

›Elevenspeed AR‹

- with **anti rust coating**
- compatible with **Shimano / Sram / Campagnolo**
- silver

›Elevenspeed‹

- compatible with **Shimano / Sram / Campagnolo**
- dark grey



›TENSPEED‹

- für **10-fach** Schaltungssysteme
- 1/2" x 11/128"
- 116 Glieder
- mit Verschlussglied
- im M-Wave Einzelkarton

301940

›Tenspeed E‹

37,90 €

- besonders geeignet für **E-Bikes**
- **längere Haltbarkeit** durch Verstärkungen
- für **Brose, Bosch, Shimano, Bafang, ...** Antriebe
- grau

301910

›Tenspeed AR‹

37,90 €

- mit **Antirost-Beschichtung**
- kompatibel zu **Shimano / Sram / Campagnolo**
- silber

301901

›Tenspeed‹

26,90 €

- kompatibel zu **Shimano / Sram / Campagnolo**
- nur **259 g** (110 Gl.)
- dunkelgrau

›TENSPEED‹

- for **10 speed**
- 1/2" x 11/128"
- 116 links
- with connecting link
- in M-Wave box

›Tenspeed E‹

- particularly suitable for **e-bikes**
- **longer durability** due to reinforcements
- for **Brose, Bosch, Shimano, Bafang, ...** drives
- grey













›Tenspeed AR‹

- with **anti rust coating**
- compatible with **Shimano / Sram / Campagnolo**
- silver

›Tenspeed‹

- compatible with **Shimano / Sram / Campagnolo**
- only **259 g** (110 li.)
- dark grey



ART.-NR. UVP	BESCHREIBUNG	DESCRIPTION	
	 ›NINESPEED‹ <ul style="list-style-type: none"> • für 9-fach Schaltungssysteme • 1/2" x 11/128" • 116 Glieder • mit Verschlussglied • im M-Wave Einzelkarton 	›NINESPEED‹ <ul style="list-style-type: none"> • for 9 speed • 1/2" x 11/128" • 116 links • with connecting link • in M-Wave box 	
301909 29,90 €	›Ninespeed AR‹ <ul style="list-style-type: none"> • mit Antirost-Beschichtung • kompatibel zu Shimano / Sram / Campagnolo • silber 	›Ninespeed AR‹ <ul style="list-style-type: none"> • with anti rust coating • compatible with Shimano / Sram / Campagnolo • silver 	
301902 19,90 €	›Ninespeed‹ <ul style="list-style-type: none"> • kompatibel zu Shimano / Sram / Campagnolo • dunkelgrau 	›Ninespeed‹ <ul style="list-style-type: none"> • compatible with Shimano / Sram / Campagnolo • dark grey 	
	   ›EIGHTSPEED‹ <ul style="list-style-type: none"> • für 8, 7, 6-fach Schaltungssysteme • auch für Nabenschaltungen geeignet • 1/2" x 3/32" • 116 Glieder • mit Verschlussglied • im M-Wave Einzelkarton 	›EIGHTSPEED‹ <ul style="list-style-type: none"> • for 8, 7, 6 speed • also suitable for internal gear hubs • 1/2" x 3/32" • 116 links • with connecting link • in M-Wave box 	
301908 19,90 €	›Eightspeed AR‹ <ul style="list-style-type: none"> • mit Antirost-Beschichtung • silber 	›Eightspeed AR‹ <ul style="list-style-type: none"> • with anti rust coating • silver 	
301907 11,90 €	›Eightspeed‹ <ul style="list-style-type: none"> • silber / grau 	›Eightspeed‹ <ul style="list-style-type: none"> • silver / grey 	
301904 7,90 €	›SEVENSPEED‹ <ul style="list-style-type: none"> • für 7, 6, 5, 1-fach Schaltungssysteme • 1/2" x 3/32" • 116 Glieder • 7,3 mm • grau / braun • mit Verschlussglied • im M-Wave Einzelkarton 	›SEVENSPEED‹ <ul style="list-style-type: none"> • for 7, 6, 5, 1 speed • 1/2" x 3/32" • 116 links • 7.3 mm • grey / brown • with connecting link • in M-Wave box 	
	   		
			

ART.-NR. BESCHREIBUNG
UVP

DESCRIPTION



›SINGLESPEED‹

- für **1-fach**
- auch für **Nabenschaltungen** geeignet
- 112 Glieder
- mit Verschlussglied
- im M-Wave Einzelkarton

›SINGLESPEED‹

- for **1 speed**
- also suitable for **internal gear hubs**
- 112 links
- with connecting link
- in M-Wave single box

301945 ›Singlespeed E‹

17,90 €

- besonders geeignet für **E-Bikes**
- **längere Haltbarkeit** durch Verstärkungen
- für **Brose, Bosch, Shimano, Bafang, ...** Antriebe
- 1/2" x 3/32"
- silber

›Singlespeed E‹

- particularly suitable for **e-bikes**
- **longer durability** due to reinforcements
- for **Brose, Bosch, Shimano, Bafang, ...** drives
- 1/2" x 3/32"
- silver



301915 ›Singlespeed AR‹

9,90 €

- mit **Antirost-Beschichtung**
- 1/2" x 1/8"
- silber

›Singlespeed AR‹

- with **anti rust coating**
- 1/2" x 1/8"
- silver



301905 ›Singlespeed‹

4,90 €

- 1/2" x 1/8"
- grau / braun

›Singlespeed‹

- 1/2" x 1/8"
- grey / brown



FÜR WERKSTÄTTEN UND MONTAGEN

FOR WORKSHOPS AND FACTORIES



KETTEN AUF ROLLE

- **15 m Rolle**
- inkl. 10 Verschlussgliedern
- im praktischen braunen Karton zum Abrollen

CHAINS ON REEL

- **15 m reel**
- incl. 10 chain connecting links
- in practical brown box to roll off



301970

17,90 €

- für **11-fach** Schaltungssysteme
- 1/2" x 11/128"
- kompatibel zu **Shimano / Sram / Campagnolo**
- grau

- for **11 speed**
- 1/2" x 11/128"
- compatible with **Shimano / Sram / Campagnolo**
- grey



301971

16,90 €

- für **10-fach** Schaltungssysteme
- 1/2" x 11/128"
- kompatibel zu **Shimano / Sram / Campagnolo**
- grau

- for **10 speed**
- 1/2" x 11/128"
- compatible with **Shimano / Sram / Campagnolo**
- grey



301972

11,90 €

- für **9-fach** Schaltungssysteme
- 1/2" x 11/128"
- kompatibel zu **Shimano / Sram / Campagnolo**
- grau

- for **9 speed**
- 1/2" x 11/128"
- compatible with **Shimano / Sram / Campagnolo**
- grey



301973

9,90 €

- für **8, 7, 6, 1-fach** Schaltungssysteme
- auch für **Nabenschaltungen** geeignet
- 1/2" x 3/32"
- silber/grau

- for **8, 7, 6, 1 speed**
- also suitable for **internal gear hubs**
- 1/2" x 3/32"
- silver/grey



301974

6,90 €

- für **7, 6, 5, 1-fach** Schaltungssysteme
- auch für **Nabenschaltungen** geeignet
- 1/2" x 3/32"
- 7,3 mm
- grau / braun

- for **7, 6, 5, 1 speed**
- also suitable for **internal gear hubs**
- 1/2" x 3/32"
- 7.3 mm
- grey / brown



301975

4,90 €

- für **1-fach** Schaltungssysteme
- auch für **Nabenschaltungen** geeignet
- 1/2" x 1/8"
- braun

- for **1 speed**
- also suitable for **internal gear hubs**
- 1/2" x 1/8"
- brown



ART.-NR. UVP
BESCHREIBUNG

DESCRIPTION



M-WAVE VERSCHLUSSGLIED

- wiederverwendbar
- 1 Set auf Eurolochkarte

M-WAVE CHAIN CONNECTING LINK

- reusable
- 1 set on eurohole card

301926
9,90 €

- ›Fusion 11‹
- für 11-fach Kette 1/2" x 11/128"
 - passend für M-Wave, **Sram, Shimano, KMC, ...**

- ›Fusion 11‹
- for 11 speed chain 1/2" x 11/128"
 - suitable for M-Wave, **Sram, Shimano, KMC, ...**



301920
5,90 €

- ›Fusion 10‹
- für 10-fach Ketten
 - 5,88 mm
 - passend für M-Wave, **Sram, Shimano, KMC, ...**

- ›Fusion 10‹
- for 10 speed chains
 - 5.88 mm
 - suitable for M-Wave, **Sram, Shimano, KMC, ...**



301921
4,90 €

- ›Fusion 9‹
- für 9-fach Ketten
 - 6,6 mm
 - passend für M-Wave, **Sram, Shimano, KMC, ...**

- ›Fusion 9‹
- für 9 speed chains
 - 6.6 mm
 - suitable for M-Wave, **Sram, Shimano, KMC, ...**



301925
3,90 €

- ›Fusion 5-8‹
- für (5/6/7) 8-fach Ketten
 - 7,3 mm

- ›Fusion 5-8‹
- for (5/6/7) 8 speed chains
 - 7.3 mm



301924
2,49 €

- SNAP ON VERSCHLUSSGLIED**
›FUSION 1‹
- für 1-fach 1/2" x 1/8"
 - grau
 - 8 mm
 - 1 Set auf Eurolochkarte

- SNAP ON CONNECTOR**
›FUSION 1‹
- for single speed 1/2" x 1/8"
 - grey
 - 8 mm
 - 1 set on eurohole card



303311
31,90 €

- KETTENFÜHRUNG**
›STEWARD UP‹
- geeignet für **1-fach** Kettenrad-garnituren
 - Montage am **Sattelrohr** Ø 34,9 mm (inkl. Adapter für 31,8 mm)
 - aus hochwertigen **Nylon-** und **Glasfasern**
 - **Aluminium**-Klemme
 - Höhenverstellung: 15 mm
 - nur 77 g (ohne Adapter)
 - auf M-Wave Eurolochkarte

- CHAIN GUIDE**
›STEWARD UP‹
- suitable for **1 speed** chainwheel sets
 - mounting at the **seat tube** Ø 34.9 mm (incl. adapter for 31.8 mm)
 - made of high quality **nylon** and **glass fibre**
 - **aluminium** clamp
 - height adjustment: 15 mm
 - only 77 g (without adapter)
 - on M-Wave eurohole card



- KETTENABWEISER**
- **verhindert** das **Herabfallen** und **Verklemmen der Kette**
 - aus Kunststoff
 - auf M-Wave Eurolochkarte

- CHAIN DEFLECTOR**
- **prevents chain** from **falling down** and **jamming**
 - made of plastic
 - on M-Wave eurohole card



300180

für **31,8 mm** Sitzrohre

for **31.8 mm** seat tubes

300181

für **34,9 mm** Sitzrohre

for **34.9 mm** seat tubes

4,90 €



ART.-NR. BESCHREIBUNG
UVP

DESCRIPTION

303312 UNIVERSAL-SCHUTZFOLIE

›PROTECTO CUT-TO-FIT‹

9,90 €

- **individuell zuschneidbar**
- selbstklebend
- **geräuschkämmend**
- **leicht formbar**
- Größe: ca. **400 x 90 mm**
- für Unterrohr, Motorengehäuse, Kettenstrebe, ...
- Material: **PU**
- schwarz
- im Polybeutel mit M-Wave Euroloch-header

UNIVERSAL PROTECTION

›PROTECTO CUT-TO-FIT‹

- **individually cut to size**
- self-adhesive
- **noise absorbing**
- **easy to shape**
- size: approx. **400 x 90 mm**
- for down tube, motor cover, chain stay, ...
- material: **PU**
- black
- in PE bag with M-Wave eurohole header

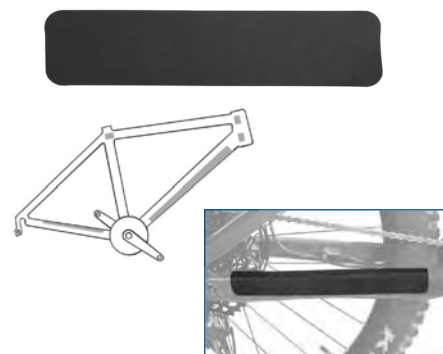

303351 SCHUTZFOLIEN-SET XL

5,90 €

- passend für die meisten Rahmen
- **universell zuschneidbarer** Schutz
- **selbstklebend**, transparent
- bestehend aus:
1 Stk. 500 x 55 mm
1 Stk. 260 x 35 mm
6 Stk. 35 x 35 mm
- im Polybeutel mit M-Wave Euroloch-header

PROTECTION FOIL SET XL

- suitable for the most frames
- **universally cuttable** protection
- **selfadhesive**, transparent
- consisting of:
1 pc 500 x 55 mm
1 pc 260 x 35 mm
6 pcs 35 x 35 mm
- in PE bag with M-Wave eurohole header

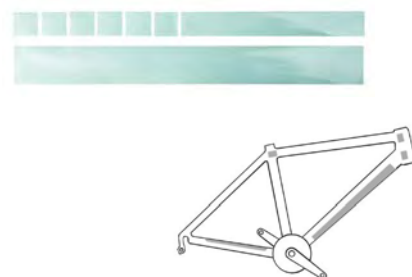

303333 KETTENSTREBENSCHUTZ

›PROTECTO XL‹

3,90 €



- schwarzes Neopren
- Größe: 260 x (100 - 130) mm
- im Polybeutel mit M-Wave Eurolochheader

CHAIN STAY PROTECTOR

›PROTECTO XL‹

- black neoprene
- size: 260 x (100 - 130) mm
- in PE bag with M-Wave eurohole header



313451 KLIKKPEDAL ›DRAG-R1‹

33,90 € / pair



- **Aluminiumkörper**
- **CrMo**-Achse
- mit **gedichteten Kugellagern**
- große Auflagefläche für hohen Komfort und optimale Kraftübertragung
- kompatibel zum **Look Keo** System (kein original Look Ersatzteil)
- mit Schuhplattenset, **9° drehbar**
- nur 327 g/Pair
- auf M-Wave Eurolochkarte

CLIPLESS PEDAL ›DRAG-R1‹

- **aluminium body**
- **CrMo** axle
- with **sealed bearings**
- large pedalling area for high comfort and great pedalling efficiency
- compatible with **Look Keo** system (no original Look spare part)
- with cleat set, **9° turnable**
- only 327 g/pair
- on M-Wave eurohole card

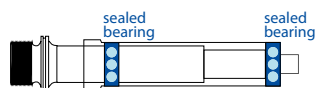

312062 KLIKKPEDAL ›DRAG-R2‹

43,90 € / pair



- **Aluminiumkörper**
- **CrMo**-Achse
- mit **gedichtetem Industriekugellager** und **hochwertigem Gleitlager**
- Montage auch mit Innensechskantschlüssel möglich
- Käfig schützt Klickmechanismus
- nur **284 g/Pair**
- mit Schuhplattenset
- kompatibel zum **Shimano** System (kein original Shimano Ersatzteil)
- auf M-Wave Eurolochkarte

CLIPLESS PEDAL ›DRAG-R2‹

- **aluminium body**
- **CrMo** axle
- with **sealed bearing** and **high quality bush bearing**
- mounting also possible with allen key
- cage protects click mechanism
- only **284 g/pair**
- with cleat set
- compatible with **Shimano** system (no original Shimano spare part)
- on M-Wave eurohole card



Tested by the manufacturer based on ISO 4210

ART.-NR. UVP	BESCHREIBUNG	DESCRIPTION	
<p>310051 22,90 € / pair</p> 	<p>PLATTFORM FÜR SYSTEMPEDALE ›TRANSFORMER A‹</p> <ul style="list-style-type: none"> • verwandelt Klickpedale in Plattformpedale • passend für SPD, Look Keo, ... Schuhplatten (kein original Shimano, Look Ersatzteil) • mit je 12 austauschbaren Aluminium-Pins • 85 x 90 mm • Aluminium • nur 38 g/Stk. • auf M-Wave Eurolochkarte 	<p>PLATFORM FOR SYSTEM PEDALS ›TRANSFORMER A‹</p> <ul style="list-style-type: none"> • changes clipless pedals to platform pedals • suitable for SPD, Look Keo, ... cleats (no original Shimano, Look spare part) • with 12 exchangeable aluminium pins each • 85 x 90 mm • aluminium • only 38 g/pcs. • on M-Wave eurohole card 	 
<p>310050 12,90 € / pair</p>	<p>PLATTFORM FÜR KLICKPEDALE ›TRANSFORMER‹</p> <ul style="list-style-type: none"> • verwandelt Klickpedale in Plattformpedale • SPD-kompatibel • mit Reflektoren • inkl. Schuhplatten-Set aus Metall • 73 x 77 mm (L x B) • auf M-Wave Eurolochkarte 	<p>PLATFORM FOR CLIPLESS PEDALS ›TRANSFORMER‹</p> <ul style="list-style-type: none"> • changes click pedals to platform pedals • SPD compatible • with reflectors • incl. metal cleat set • 73 x 77 mm (L x W) • on M-Wave eurohole card 	 
<p>312150 59,90 € / pair</p>  	<p>PLATTFORM-KOMBIPEDAL ›FREEDOM CLIPLESS‹</p> <ul style="list-style-type: none"> • CNC-gefräster Aluminiumkörper • CrMo-Achse • mit gedichtetem Industriekugellager und hochwertigem Gleitlager • Montage auch mit Innensechskant möglich • mit Schuhplatten-set • kompatibel zum Shimano System (kein original Shimano Ersatzteil) • mit austauschbaren Pins auf einer Seite • Trittfläche: ca. 92 x 102 mm (L x B) • nur 437 g • auf M-Wave Eurolochkarte 	<p>PLATFORM COMBINATION PEDAL ›FREEDOM CLIPLESS‹</p> <ul style="list-style-type: none"> • CNC machined aluminium body • CrMo axle • with sealed bearing and high quality bush bearing • mounting also possible with allen key • with cleat set • compatible with Shimano system (no original Shimano spare part) • with exchangeable pins at one side • tread surface: approx. 92 x 102 mm (L x W) • only 437 g • on M-Wave eurohole card 	    <div data-bbox="1308 1512 1492 1556" style="border: 1px solid black; padding: 2px;"> <p>Tested by the manufacturer based on ISO 4210</p> </div>
<p>311099 43,90 € / pair</p>  	<p>KOMBIPEDAL ›PEASY‹</p> <ul style="list-style-type: none"> • Doppelfunktionspedale: beidseitig verwendbar für normale (Sport-)Schuhe und für Klick-Schuhe • Aluminiumkörper und -käfig • silberne, CNC-gefräste CrMo-Achse • mit Industriekugellagern • nur 319 g/Paar (ohne Reflektoren) • mit abnehmbaren Reflektoren • mit deutschem Prüfzeichen • mit Schuhplattenset (auch passend für Shimano Pedale) • Pedal passt auch für Shimano Schuhplatten (kein original Shimano Ersatzteil) • Trittfläche: 63 x 80 mm (L x B) • auf M-Wave Eurolochkarte 	<p>COMBINATION PEDAL ›PEASY‹</p> <ul style="list-style-type: none"> • double function pedals: useable on both sides for normal (sport)-shoes and for clipless shoes • aluminium body and cage • silver CNC machined CrMo axle • with sealed bearings • only 319 g/pair (without reflectors) • with detachable reflectors • with German approval number • with cleat set (also suitable for Shimano pedals) • pedal also suitable for Shimano cleats (no original Shimano spare part) • tread surface: 63 x 80 mm (L x W) • on M-Wave eurohole card 	   <div data-bbox="1308 2049 1492 2094" style="border: 1px solid black; padding: 2px;"> <p>Tested by the manufacturer based on ISO 4210</p> </div>

ART.-NR. BESCHREIBUNG
UVP

DESCRIPTION

312060
45,90 € / pair

KOMBIPEDAL ›DRAG-T1‹



- Aluminiumkörper
- mit **Antirutschauflage**
- CrMo-Achse mit Innensechskantschlüssel-Kopf
- mit Industriekugellager
- nur 349 g/Paar
- Pedal passt auch für **Shimano Schuhplatten** (kein original Shimano Ersatzteil)
- Trittfläche: 95 x 73 mm (L x B)
- auf M-Wave Eurolochkarte

COMBINATION PEDAL ›DRAG-T1‹

- aluminium body
- with **non-slip rubber layer**
- CrMo-Achse axle with allen key head
- with sealed bearing
- only 349 g/pair
- pedal also suitable for **Shimano cleats** (no original Shimano spare part)
- tread surface: 95 x 73 mm (L x W)
- on M-Wave eurohole card



Tested by the manufacturer based on ISO 4210

312061
37,90 € / pair

KOMBIPEDAL ›DRAG-T2‹



- **Doppelfunktionspedale:** beidseitig verwendbar für normale (**Sport-Schuhe**) und für **Klick-Schuhe**
- Aluminiumkörper
- **einfacher Einstieg**
- **verchromte CrMo-Achse**
- Montage auch mit **Innensechskantschlüssel** möglich
- mit **Non-Slip** Gummiauflage
- mit Schuhplattenset (auch **passend für Shimano Pedale**)
- Pedal passt auch für **Shimano Schuhplatten** (kein original Shimano Ersatzteil)
- Trittfläche: 72 x 99 mm (L x B)
- auf M-Wave Eurolochkarte

COMBINATION PEDAL ›DRAG-T2‹

- **double function pedals:** useable on both sides for normal (**sport-shoes**) and for **clipless shoes**
- aluminium body
- **easy step-in system**
- **chromed CrMo axle**
- mounting also possible with **allen key**
- with **non-slip** rubber layer
- with cleat set (also **suitable for Shimano pedals**)
- pedal also suitable for **Shimano cleats** (no original Shimano spare part)
- tread surface: 72 x 99 mm (L x W)
- on M-Wave eurohole card



Tested by the manufacturer based on ISO 4210



PEDAL ›STEADY-A3‹

- **Aluminiumkörper** und **-käfig**
- silberne **CrMo-Achse**
- mit **deutschem Prüfzeichen**
- mit **Reflektoren**
- Montage auch mit **Innensechskant** möglich
- **extra breite Trittfläche:** 82 x 103 mm (L x B)



PEDAL ›STEADY-A3‹

- **aluminium body** and **cage**
- silver **CrMo axle**
- with **German approval number**
- with **reflectors**
- mounting also possible with **allen key**
- **extra wide tread surface:** 82 x 103 mm (L x W)



311710 Montageverpackung

OEM

311109 auf M-Wave Eurolochkarte

on M-Wave eurohole card

16,90 € / pair

Tested by the manufacturer based on ISO 4210

PEDAL ›STEADY-A4‹

- **Aluminiumkörper** und **-käfig**
- **gedichtete**, verchromte **CrMo-Achse**
- Montage mit **Innen-** und **Außen-sechskantschlüssel** möglich
- Trittfläche: 64 x 94 mm (L x B)

silberner Käfig

PEDAL ›STEADY-A4‹

- **aluminium body** and **cage**
- **sealed**, c. p. **CrMo axle**
- mounting possible with **allen key** and **open hex wrench**
- tread surface: 64 x 94 mm (L x W)

silver cage

311024 Montageverpackung

OEM

311112 auf M-Wave Eurolochkarte

on M-Wave eurohole card

schwarzer Käfig

black cage

311063 Montageverpackung

OEM

311113 auf M-Wave Eurolochkarte

on M-Wave eurohole card

14,90 € / pair

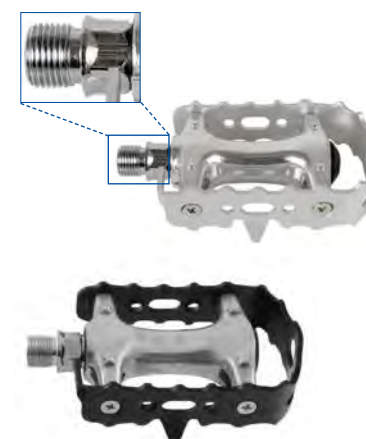

Tested by the manufacturer based on ISO 4210

ART.-NR. UVP
BESCHREIBUNG

DESCRIPTION



PEDAL ›STEADY-A 2‹

- Aluminiumkörper und -käfig
- 9/16"-Boron-Achse mit hochwertigem Polymer-Gleitlager
- mit Reflektoren
- mit deutschem Prüfzeichen
- Montage auch mit Innensechskantschlüssel möglich
- Trittfläche: 62 x 90 mm (L x B)

PEDAL ›STEADY-A 2‹

- aluminium body and cage
- 9/16" boron axle with high-quality polymer plain bearing
- with reflectors
- with German approval number
- mounting also possible with allen key
- tread surface: 62 x 90 mm (L x W)



311107 Montageverpackung

OEM

311108 auf M-Wave Eurolochkarte

on M-Wave eurohole card

14,90 € / pair

Tested by the manufacturer based on ISO 4210



PEDAL ›STEADY-A‹

- Aluminiumkörper
- Stahlkäfig
- mit Reflektoren
- mit deutschem Prüfzeichen
- Trittfläche: 60 x 92 mm (L x B)

PEDAL ›STEADY-A‹

- aluminium body
- steel cage
- with reflectors
- with German approval number
- tread surface: 60 x 92 mm (L x W)



311317 Montageverpackung

OEM

311320 auf M-Wave Eurolochkarte

on M-Wave eurohole card

9,90 € / pair

PEDAL ›STEADY-A5‹

- Aluminiumkörper und -käfig
- Trittfläche: 70 x 94 mm (L x B)

PEDAL ›STEADY-A5‹

- aluminium body and cage
- tread surface: 70 x 94 mm (L x W)



311049 Montageverpackung

OEM

311114 auf M-Wave Eurolochkarte

on M-Wave eurohole card

8,90 € / pair



PEDAL ›STEADY-K1‹

- Kunststoffkörper
- Stahlkäfig
- mit Reflektoren
- mit deutschem Prüfzeichen
- Trittfläche: 61 x 95 mm (L x B)

PEDAL ›STEADY-K1‹

- PP body
- steel cage
- with reflectors
- with German approval number
- tread surface: 61 x 95 mm (L x W)



311319 Montageverpackung

OEM

311115 auf M-Wave Eurolochkarte

on M-Wave eurohole card

8,90 € / pair



ANTI-RUTSCHPEDAL

- schwarzer Aluminiumkörper
- mit schwarzer Non-Slip Gummiauflage
- mit deutschem Prüfzeichen
- mit Reflektoren
- Trittfläche: 80 x 92 mm (L x B)

NON-SLIP PEDAL

- black aluminium body
- with black non-slip rubber layer
- with German approval number
- with reflectors
- tread surface: 80 x 92 mm (L x W)



311509 Montageverpackung

OEM

311504 auf M-Wave Eurolochkarte

on M-Wave eurohole card

19,90 € / pair

ART.-NR. BESCHREIBUNG
UVP

DESCRIPTION



ANTI-RUTSCHPEDAL
›STEADY FLAT 2 AL‹

- **Aluminiumkörper**
- **Boron-Achse**
- mit hochwertigem **Polymer-Gleitlager**
- mit **deutschem Prüfzeichen**
- mit **Non-Slip Gummiauflage**
- mit **Reflektoren**
- Trittfläche: 82 x 96 mm (L x B)
- Montage auch mit **Innensechskant** möglich

NON-SLIP PEDAL
›STEADY FLAT 2 AL‹

- **aluminium body**
- **Boron axle**
- with high-quality **polymer plain bearing**
- with **german approval number**
- with **non-slip rubber layer**
- with **reflector**
- tread surface: 82 x 96 mm (L x W)
- mounting also possible with **allen key**



312012 Montageverpackung

OEM

312013 auf M-Wave Eurolochkarte

on M-Wave eurohole card

19,90 € / pair

Tested by the manufacturer based on ISO 4210



ANTI-RUTSCHPEDAL
›STEADY-A6‹

- **Aluminiumkörper und -käfig**
- mit **großer schwarzer Gummi-auflagefläche**
- Boron-Achse
- mit **deutschem Prüfzeichen**
- mit **Reflektoren**
- Trittfläche: 73 x 97 mm (L x B)

NON-SLIP PEDAL
›STEADY-A6‹

- **aluminium body and cage**
- with **big black rubber surface**
- boron axle
- with **German approval number**
- with **reflectors**
- tread surface: 73 x 97 mm (L x W)



311830 Montageverpackung

OEM

311116 auf M-Wave Eurolochkarte

on M-Wave eurohole card

16,90 € / pair

Tested by the manufacturer based on ISO 4210



ANTI-RUTSCHPEDAL
›STEADY-A7‹

- **Aluminiumkörper und -käfig**
- anatomisch geformte, **konkave Trittfläche** mit **Aluminium-Non-Slip-Profil**
- schwarze, **gedichtete Boron-Achse**
- mit **Reflektoren**
- mit **deutschem Prüfzeichen**
- nur 379 g/Pair
- Trittfläche: 81 x 97 mm (L x B)

NON-SLIP PEDAL
›STEADY-A7‹

- **aluminium body and cage**
- anatomic shaped, **concave platform** with **aluminium non slip profile**
- black, **sealed boron axle**
- with **reflectors**
- with **German approval number**
- only 379 g/pair
- tread surface: 81 x 97 mm (L x W)



ANATOMIC

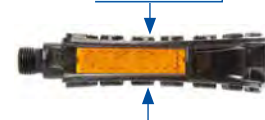

311106 Montageverpackung

OEM

311117 auf M-Wave Eurolochkarte

on M-Wave eurohole card

12,90 € / pair



ANTI-RUTSCHPEDAL
›STEADY C‹

- **Aluminiumkörper**
- **CrMo-Achse**
- mit **Non-Slip Gummiauflage**
- mit **Reflektoren**
- mit **deutschem Prüfzeichen**
- Montage auch mit **Innensechskant** möglich
- Trittfläche: 80 x 95 mm (L x B)

NON-SLIP PEDAL
›STEADY C‹

- **aluminium body**
- **CrMo axle**
- with **non-slip rubber layer**
- with **reflectors**
- with **German approval number**
- mounting also possible with **allen key**
- tread surface: 80 x 95 mm (L x W)



311121 Montageverpackung

OEM

311040 auf M-Wave Eurolochkarte

on M-Wave eurohole card

11,90 € / pair

ART.-NR. UVP	BESCHREIBUNG	DESCRIPTION	
 311000 311122 12,90 € / pair	ANTI-RUTSCHPEDAL ›STEADY-A8‹ <ul style="list-style-type: none"> • Aluminiumkörper und -käfig • CNC-gefräste CrMo-Achse • mit Non-Slip Gummiauflage • mit Kugellager • mit Reflektoren • mit deutschem Prüfzeichen • Trittfläche: 70 x 95 mm (L x B) 	NON-SLIP PEDAL ›STEADY-A8‹ <ul style="list-style-type: none"> • aluminium body and cage • CNC machined CrMo axle • with non-slip rubber layer • with ball bearing • with reflectors • with German approval number • tread surface: 70 x 95 mm (L x W) 	 <div style="border: 1px solid black; padding: 2px; font-size: 8px;"> Tested by the manufacturer based on ISO 4210 </div>
 311002 311123 9,90 € / pair	ANTI-RUTSCHPEDAL ›STEADY-A9‹ <ul style="list-style-type: none"> • Aluminiumkörper und -käfig • mit Non-Slip Gummiauflage • mit Reflektoren • mit deutschem Prüfzeichen • Trifffläche: 70 x 96 mm (L x B) 	NON-SLIP PEDAL ›STEADY-A9‹ <ul style="list-style-type: none"> • aluminium body and cage • with non-slip rubber layer • with reflectors • with German approval number • tread surface: 70 x 96 mm (L x W) 	
 311139 311140 41,90 € / pair	ANTI-RUTSCHPEDAL ›STEADY SAND‹ <ul style="list-style-type: none"> • Aluminiumkörper mit sandartiger Anti-Rutschauflage • mit Industriekugellager • CrMo-Achse • mit deutschem Prüfzeichen • mit Reflektoren • Trittfläche: 85 x 92 mm (L x B) 	NON-SLIP PEDAL ›STEADY SAND‹ <ul style="list-style-type: none"> • aluminium body with sandlike non-slip layer • with sealed bearing • CrMo axle • with German approval number • with reflectors • tread surface: 85 x 92 mm (L x W) 	 
   311523 311503 12,90 € / pair	ANTI-RUTSCHPEDAL ›STEADY FLAT‹ <ul style="list-style-type: none"> • Kunststoffkörper mit sandartiger Anti-Rutschauflage • Boron-Achse • mit hochwertigem Polymer-Gleitlager • mit deutschem Prüfzeichen • mit Reflektoren • Montage auch mit Innensechskant möglich • Trittfläche: 86 x 96 mm (L x B) 	NON-SLIP PEDAL ›STEADY FLAT‹ <ul style="list-style-type: none"> • plastic body with sandlike non-slip layer • boron axle • with high-quality polymer plain bearing • with german approval number • with reflectors • mounting also possible with allen key • tread surface: 86 x 96 mm (L x W) 	

ART.-NR. BESCHREIBUNG
UVP

DESCRIPTION



**ANTI-RUTSCHPEDAL
>STEADY BEACH<**

- schwarzer Kunststoffkörper mit **doppelter Anti-Rutschauflage:**
 - sandartige Oberfläche
 - high-low Noppen
- **Boron**-Achse
- anatomisch geformte, konkave Auflagefläche
- mit **Reflektoren**
- mit **deutschem Prüfzeichen**
- Montage auch mit **Innensechskant** möglich
- Trittfläche: 89 x 97 mm (L x B)



**NON-SLIP PEDAL
>STEADY BEACH<**

- black plastic body with **double non-slip layer**
 - sandlike surface
 - high-low knobs
- **boron** axle
- anatomically shaped concave supporting surface
- with **reflectors**
- with **German approval number**
- mounting also possible with **allen key**
- tread surface: 89 x 97 mm (L x W)



ANATOMIC



311502 auf M-Wave Eurolochkarte

on M-Wave eurohole card

311500 Montageverpackung

OEM

8,90 € / pair



**ANTI-RUTSCHPEDAL
>STEADY C ECO<**

- Kunststoffkörper
- **CrMo**-Achse
- mit **Kugellager**
- mit **Non-Slip Gummiauflage**
- mit **Reflektoren**
- mit **deutschem Prüfzeichen**
- Montage auch mit **Innensechskant** möglich
- Trittfläche: 80 x 95 mm (L x B)

**NON-SLIP PEDAL
>STEADY C ECO<**

- plastic body
- **CrMo** axle
- with **ball bearing**
- with **non-slip rubber layer**
- with **reflectors**
- with **German approval number**
- mounting also possible with **allen key**
- tread surface: 80 x 95 mm (L x W)



311124 Montageverpackung

OEM

311041 auf M-Wave Eurolochkarte

on M-Wave eurohole card

6,90 € / pair



**ANTI-RUTSCHPEDAL
>STEADY K2<**

- mit **Non-Slip TPR-Auflage**
- mit **Kugellager**
- mit **Reflektoren**
- mit **extra großer Trittfläche:** 75 x 96 mm (L x B)

**NON-SLIP PEDAL
>STEADY K2<**

- with **non-slip TPR-layer**
- with **ball bearing**
- with **reflectors**
- with **extra wide tread surface:** 75 x 96 mm (L x W)



311011 mit **deutschem Prüfzeichen**

with **German approval number**



ohne deutsches Prüfzeichen

without German approval number

311508 Montageverpackung

OEM

311125 auf M-Wave Eurolochkarte

on M-Wave eurohole card

4,90 € / pair

ART.-NR. UVP	BESCHREIBUNG	DESCRIPTION
-----------------	--------------	-------------



**ANTI-RUTSCHPEDAL
›STEADY FLAT 2‹**

- **Non-Slip Profil**
- Kunststoffkörper
- **Boron-Achse**
- mit hochwertigem **Polymer-Gleitlager**
- Montage auch mit **Innensechskant** möglich
- mit **Reflektoren**
- mit **deutschem Prüfzeichen**
- Trittfläche: 84 x 93 mm (L x B)

312011 auf M-Wave Eurolochkarte

312010 Montageverpackung

6,90 € / pair

**NON-SLIP PEDAL
›STEADY FLAT 2‹**

- **non-slip profile**
- plastic body
- **boron axle**
- with high-quality **polymer plain bearing**
- mounting also possible with **allen key**
- with **reflectors**
- with **german approval number**
- tread surface: 84 x 93 mm (L x W)

on M-Wave eurohole card

OEM



PEDAL ›STEADY K3‹

- schwarzer Kunststoffkörper
- **mit Kugellager**
- Trittfläche: 72 x 95 mm (L x B)
- mit **Reflektoren**

mit **deutschem Prüfzeichen**

313306 Montageverpackung

311126 auf M-Wave Eurolochkarte

4,90 € / pair

ohne deutsches Prüfzeichen

313301 Montageverpackung

311127 auf M-Wave Eurolochkarte

3,90 € / pair

PEDAL ›STEADY K3‹

- black plastic body
- **with ball bearing**
- tread surface: 72 x 95 mm (L x W)
- with **reflectors**

with **German approval number**

OEM

on M-Wave eurohole card

without German approval number

OEM

on M-Wave eurohole card



**KINDER- UND JUGEND-
ANTI-RUTSCHPEDAL
›STEADY-K4‹**

- schwarzer Kunststoffkörper
- mit grauer **Non-Slip Gummiauflage**
- mit **Reflektoren**
- mit **deutschem Prüfzeichen**
- Trittfläche: 60 x 82 mm (L x B)

311046 Montageverpackung

311128 auf M-Wave Eurolochkarte

4,90 € / pair

**KIDS AND JUVENILE
NON-SLIP PEDAL
›STEADY-K4‹**

- black PP body
- with grey **non-slip rubber layer**
- with **reflectors**
- with **German approval number**
- tread surface: 60 x 82 mm (L x W)

OEM

on M-Wave eurohole card



FALTPEDAL ›STEADY-F1‹

- **Aluminium/Kunststoffkörper**
- **CrMo-Achse**
- **leicht und sicher faltbar**
- **beidseitig** verwendbar
- mit **Non-Slip Gummiauflage**
- mit **Reflektoren**
- mit **deutschem Prüfzeichen**
- Trittfläche: 69 x 98 mm (L x B)

311765 Montageverpackung

311129 auf M-Wave Eurolochkarte

13,90 € / pair

FOLDING PEDAL ›STEADY-F1‹

- **aluminium/PP body**
- **CrMo axle**
- **simply and safely foldable**
- usable on **both sides**
- with **non-slip rubber layer**
- with **reflectors**
- with **German approval number**
- tread surface: 69 x 98 mm (L x W)

OEM

on M-Wave eurohole card



ART.-NR. BESCHREIBUNG
UVP

DESCRIPTION



PLATTFORM-PEDAL
›FREEDOM SL‹

- CNC gefräster Aluminiumkörper
- CNC gefräste CrMo-Achse
- mit **Industriekugellager**
- Montage auch mit Innensechskant möglich
- mit austauschbaren Pins
- gemäß **ISO 4210**: erhöhte Anforderungen bis **140 kg**
- nur **297 g**/Paar
- Trittfläche: 96 x 91 mm (L x B)



FLAT PEDAL
›FREEDOM SL‹

- CNC machined aluminium body
- CNC machined CrMo axle
- with **sealed bearing**
- mounting also possible with allen key
- with interchangeable pins
- based on **ISO 4210**: increased requirements up to **140 kg**
- only **297 g**/pair
- tread surface: 96 x 91 mm (L x W)



schwarz
311130 Montageverpackung

black
OEM

313340 auf M-Wave Eurolochkarte

on M-Wave eurohole card

titan grau
311131 Montageverpackung

titan grey
OEM

313341 auf M-Wave Eurolochkarte
39,90 € / pair

on M-Wave eurohole card

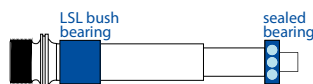

Tested by the manufacturer based on ISO 4210



PLATTFORM-PEDAL
›FREEDOM CS‹

- **sehr großer und stabiler Nylonkörper**
- besonders **große XXL-Trittfläche**: **120 x 110 mm** (L x B)
- **CrMo-Achse**
- mit **2 gedichteten Industriekugellagern**
- mit **austauschbaren Pins**
- nur **328 g**/Paar



FLAT PEDAL
›FREEDOM CS‹

- **very large and stable nylon body**
- extra **wide XXL tread surface**: **120 x 110 mm** (L x W)
- **CrMo axle**
- with **2 sealed bearings**
- with **exchangeable pins**
- only **328 g**/pair

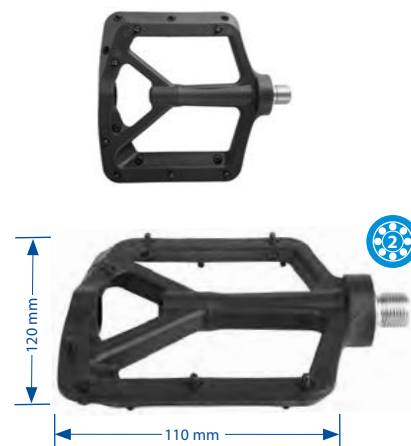

311132 Montageverpackung

OEM

313350 auf M-Wave Eurolochkarte
24,90 € / pair

on M-Wave eurohole card

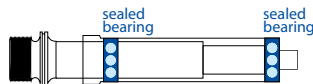

PLATTFORM-PEDAL
›STEADY FLAT 3‹

- **Aluminiumkörper**
- Montage auch mit Innensechskant möglich
- mit **hochwertigem Polymer-Gleitlager**
- mit austauschbaren Pins
- mit **Reflektoren**
- mit **deutschem Prüfzeichen**
- nur **397 g**/Paar
- Trittfläche: 93 x 97 mm (L x B)



FLAT PEDAL
›STEADY FLAT 3‹

- **aluminium body**
- mounting also possible with allen key
- with **high quality polymer plain bearing**
- with interchangeable pins
- with **reflectors**
- with **German approval number**
- only **397 g**/pair
- tread surface: 93 x 97 mm (L x W)



311532 auf M-Wave Eurolochkarte

on M-Wave eurohole card

311531 Montageverpackung

OEM

24,90 € / pair

ART.-NR. UVP **BESCHREIBUNG**

DESCRIPTION



PLATTFORM-PEDAL ›FLAT‹

- **Aluminiumkörper**
- **gedichtete** Achse
- mit **hochwertigem Polymer**-Gleitlager
- mit austauschbaren Pins
- nur 398 g/Pair
- Trittfläche: 105 x 94 mm (L x B)

FLAT PEDAL ›FLAT‹

- **aluminium body**
- **sealed** axle
- with **high quality polymer** plain bearing
- with exchangeable pins
- only 398 g/pair
- tread surface: 105 x 94 mm (L x W)



311133 Montageverpackung

OEM

313315 auf M-Wave Eurolochkarte

on M-Wave eurohole card

19,90 € / pair



PLATTFORM-PEDAL ›STEADY-A10‹

- **Aluminiumkörper**
- **Boron**-Achse
- Montage mit **Innen-** und **Außen-sechskantschlüssel** möglich
- mit **hochwertigem Polymer**-Gleitlager
- mit **Reflektoren**
- mit **deutschem Prüfzeichen**
- Trittfläche: 84 x 90 mm (L x B)

FLAT PEDAL ›STEADY-A10‹

- **aluminium body**
- **boron** axle
- mounting possible with **allen key** and **open hex wrench**
- with **high quality polymer** plain bearing
- with **reflectors**
- with **German approval number**
- tread surface: 84 x 90 mm (L x W)



312014 Montageverpackung

OEM

311134 auf M-Wave Eurolochkarte

on M-Wave eurohole card

11,90 € / pair

BMX-PEDAL ›FREEDOM PE‹

- aus **Polycarbonat**
- Trittfläche: 95 x 104 mm (L x B)

BMX PEDAL ›FREEDOM PE‹

- **polycarbonate** body
- tread surface: 95 x 104 mm (L x W)



Tested by the manufacturer based on ISO 4210

311135 Montageverpackung

OEM

311380 auf M-Wave Eurolochkarte

on M-Wave eurohole card

8,90 € / pair



PLATTFORM-PEDAL ›STEADY-K6‹

- Kunststoffkörper
- **anatomisch** geformte, konkave Auflagefläche
- **CrMo**-Achse
- mit 2 **Kugellagern**
- mit **deutschem Prüfzeichen**
- mit **Reflektoren**
- Montage auch mit **Innensechskant** möglich
- **XL**-Trittfläche: 106 x 101 mm (L x B)



FLAT PEDAL ›STEADY-K6‹

- plastic body
- **anatomically** shaped concave supporting surface
- **CrMo** axle
- with 2 **ball bearings**
- with **German approval number**
- with **reflectors**
- mounting also possible with **allen key**
- **XL** tread surface: 106 x 101 mm (L x W)



ANATOMIC



313181 auf M-Wave Eurolochkarte

on M-Wave eurohole card



313180 Montageverpackung





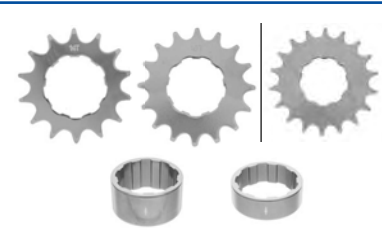

OEM

5,90 € / pair

Tested by the manufacturer based on ISO 4210



ART.-NR. UVP	BESCHREIBUNG	DESCRIPTION		
	PLATTFORM-PEDAL ›STEADY-K5‹ <ul style="list-style-type: none"> • Kunststoffkörper • mit 2 Kugellagern • mit Reflektoren • Trittfläche: 96 x 95 mm (L x B) 	FLAT PEDAL ›STEADY-K5‹ <ul style="list-style-type: none"> • plastic body • with 2 ball bearings • with reflectors • tread surface: 96 x 95 mm (L x W) 		
	9/16" Achse	9/16" axle		
313310	Montageverpackung	OEM		
311136	auf M-Wave Eurolochkarte	on M-Wave eurohole card		
	1/2" Achse	1/2" axle		
313311	Montageverpackung	OEM		
311137	auf M-Wave Eurolochkarte	on M-Wave eurohole card		
4,90 € / pair				
	RENNRADPEDAL ›STEADY-A11‹ <ul style="list-style-type: none"> • Aluminiumkörper und -käfig • CrMo-Achse • Pedalhaken nachrüstbar • Trittfläche: 62 x 96 mm (L x B) 	ROAD PEDAL ›STEADY-A11‹ <ul style="list-style-type: none"> • aluminium body and cage • CrMo axle • toe clips attachable • tread surface: 62 x 96 mm (L x W) 		
	313461	Montageverpackung		OEM
	311138	auf M-Wave Eurolochkarte		on M-Wave eurohole card
10,90 € / pair				
122900	PEDALTASCHE ›ROTTERDAM PEDAL P‹ <ul style="list-style-type: none"> • 2 Taschen für 1 Paar Pedale • aus Neopren • als Transporttaschen oder zum Schutz am Rad verwendbar • ca. 135 x 145 mm • 1 Paar auf M-Wave Eurolochkarte 	PEDAL BAG ›ROTTERDAM PEDAL P‹ <ul style="list-style-type: none"> • 2 bags for 1 pair of pedals • made of neoprene • suitable as transport bags or as protection on the bike • approx. 135 x 145 mm • 1 pair on M-Wave eurohole card 		
10,90 € / pair				
311812	SCHUHPLATTEN-SET ›CLEAT S‹ <ul style="list-style-type: none"> • Shimano kompatibel (kein original Shimano Ersatzteil) • passend für Klick-Pedale Art. 311099/310/804/11/35/47/49/52/64/66/67/2060/1/2, ... • mit Befestigungsteilen • paarweise in M-Wave Blisterverpackung 	CLEAT SET ›CLEAT S‹ <ul style="list-style-type: none"> • Shimano compatible (no original Shimano spare part) • suitable for clipless pedals art. 311099/310/804/11/35/47/49/52/64/66/67/2060/1/2, ... • with mounting parts • one pair in M-Wave blister packaging 		
9,90 € / set				
311836	SCHUHPLATTEN-SET ›CLEAT L‹ <ul style="list-style-type: none"> • Look Keo kompatibel • 5° seitliche Bewegungsfreiheit • passend für Art. 311821/53/55, 313451, ... • mit Befestigungsteilen • paarweise in M-Wave Blisterverpackung 	CLEAT SET ›CLEAT L‹ <ul style="list-style-type: none"> • Look Keo compatible • 5° lateral tolerance • suitable for art. 311821/53/55, 313451, ... • with mounting parts • one pair in M-Wave blister packaging 		
9,90 € / set				

ART.-NR. UVP	BESCHREIBUNG	DESCRIPTION	
320070 14,90 € / set	SINGLE-SPEED-UMRÜSTKIT zur Umrüstung von Shimano 8/9/10-fach Kassettennabe auf Single Speed <ul style="list-style-type: none"> • 3 x Zahnkränze 14, 16 und 18 Zähne • 2 x flexibel anbringbare Distanzringe (13,25 und 20,25 mm Breite) zur Optimierung der Kettenlinie durch 4 verschiedene Positionen • auf M-Wave Eurolochkarte 	SINGLE SPEED REFIT SET for conversion from Shimano 8/9/10 speed cassette hub to single speed <ul style="list-style-type: none"> • 3 x sprockets 14, 16 and 18 teeth • 2 x flexibly attachable spacers (13.25 and 20.25 mm width) for optimizing the chain line through 4 different positions • on M-Wave eurohole card 	 

	STECKACHSE MIT HEBEL <ul style="list-style-type: none"> • versenkbarer Schnellspann-Hebel • Aluminium • Gewindesteigung 1,5 mm • Montageverpackung 	THRU AXLE WITH LEVER <ul style="list-style-type: none"> • hidden QR lever • aluminium • thread pitch 1.5 mm • OEM 	
321195 36,90 €  55 g	›Scrax B-12 148 QR‹ <ul style="list-style-type: none"> • Einbaumaß 148 mm • M12 x Länge 178 mm • nur 55 g • Gewindelänge 18 mm • z. B. für MTB- oder E-Bike-Rahmen 	›Scrax B-12 148 QR‹ <ul style="list-style-type: none"> • OLD 148 mm • M12 x length 178 mm • only 55 g • thread length: 18 mm • e. g. for MTB or e-bike frames 	
321138 36,90 €  53 g	›Scrax B-12 142 QR‹ <ul style="list-style-type: none"> • Einbaumaß 142 mm • M12 x Länge 157 mm • nur 53 g • Gewindelänge 10 mm • z. B. für Gravel-Rahmen Art. 666141-5 	›Scrax B-12 142 QR‹ <ul style="list-style-type: none"> • OLD 142 mm • M12 x length 157 mm • only 53 g • thread length: 10 mm • e. g. for Gravel frame art. 666141-5 	

Hub Accessories

321193 19,90 €	STECKACHSE ›SCRAX B-12 148‹ <ul style="list-style-type: none"> • Einbaumaß 148 mm • Boost Standard • 6 mm Innensechskant Fixierung • M12 x Länge 178 mm • Gewindesteigung: 1,5 mm • Gewindelänge: 20 mm • Montageverpackung 	THRU AXLE ›SCRAX B-12 148‹ <ul style="list-style-type: none"> • OLD 148 mm • boost standard • 6 mm allen screw fixation • M12 x length 178 mm • thread pitch: 1.5 mm • thread length: 20 mm • OEM 	
--------------------------	---	---	---

	SCHNELLSPANNER Diebstahlschutz , da mit Innensechskant-Fixierung	QUICK RELEASE theft protection due to allen screw fixation	
321116 4,90 €	• für Vorderradnabe • Einbaumaß: 100 mm • Montageverpackung	• for front hub • OLD: 100 mm • OEM	
321117 4,90 €	• für Hinterradnabe • Einbaumaß: 130-135 mm • Montageverpackung	• for rear hub • OLD: 130-135 mm • OEM	
321135 9,90 €	• Set für Vorder- und Hinterradnabe • Einbaumaße: 100 mm / 130-135 mm • auf M-Wave Eurolochkarte	• set for front and rear hub • OLD: 100 mm / 130-135 mm • on M-Wave eurohole card	

ART.-NR. UVP
BESCHREIBUNG

DESCRIPTION



STECKACHSE FÜR ANHÄNGER-KUPPLUNG
›STALWART AXLE‹



- durch Innengewinde auch zur **Montage von Gepäckträgern an Steckachsen** geeignet
- zur **werkzeuglosen Montage von Standard Fahrrad-Anhänger-Kupplungen** an **12 mm Steckachs-naben**
- **2 in 1:** durch 6 mm Distanzscheibe passend für 12 mm Steckachs-naben mit **142 mm** Einbaumaß und für **Boost-Naben** mit **148 mm** Einbaumaß
- Aluminium
- mit Schnellspanner
- auch **ohne Schnellspanner als saubere Lösung** für Steckachsen nutzbar
- mit **zusätzlichem Innengewinde** für M6-Schraube für z. B. Gepäckträgermontage
- mit zusätzlichen Unterlegscheiben zur **Einstellung der Schnellspannhebel-Position**
- auf M-Wave Eurolochkarte

THRU AXLE FOR TRAILER MOUNT
›STALWART AXLE‹

- due to the internal thread also suitable for **mounting carriers to thru axles**
- for **toolless mounting of standard bicycle trailer adapters** at **12 mm thru axle hubs**
- **2 in 1:** by 6 mm spacer suitable for 12 mm thru axle hubs with OLD **142 mm** and for **boost hubs** with OLD **148 mm**
- aluminium
- with QR
- also usable **without QR as clean solution** for quick-release axle
- with **additional internal thread** for M6 screw for e. g. luggage rack mounting
- with additional spacers for **adjusting the QR lever position**
- on M-Wave eurohole card

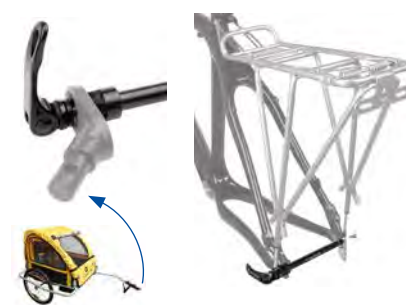

640140

- **Shimano Type**
(kein original Shimano Ersatzteil)
- Gewindesteigung: P1.5 x T20

- **Shimano Type**
(no original Shimano spare part)
- thread pitch: P1.5 x T20



640141

- **Maxle Type**
(kein original Maxle Ersatzteil)
- Gewindesteigung: P1.75 x T20

- **Maxle Type**
(no original Maxle spare part)
- thread pitch: P1.75 x T20

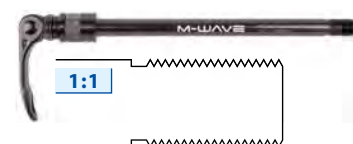

640142

44,90 €

- **Syntaxe Type**
(kein original Syntaxe Ersatzteil)
- Gewindesteigung: P1.0 x T20
- mit konischer Verbindungsscheibe

- **Syntaxe Type**
(no original Syntaxe spare part)
- thread pitch: P1.0 x T20
- with conical spacer



440490 **SCHNELLSPANNER**

9,90 €

- **zur Montage von Gepäckträgern an Räder:**
 - **ohne Befestigungsösen** (z. B. Rennräder)
 - mit **hinderlichen Sitzrohr- oder Kettenstreben, Ausfallenden, ...**
- passend auch für **Fahrradanhänger** Art. 640050, ...
- mit 8 je 5 mm breiten **Adapter-scheiben**
- **Aluminiumhebel**
- Länge 210 mm
- für Nabeneinbaumaß: ≥ 130 mm
- **Einklembreite: 137 mm - 177 mm** (in 5 mm Schritten)
- auf M-Wave Eurolochkarte

QUICK RELEASE

- **for mounting of carriers to bicycles:**
 - **without mounting eyelets** (e. g. road bikes)
 - with **obstructive seat stays, chain stays, derailleur hangers, ...**
- also suitable for **bicycle trailer** art. 640050, ...
- with **8 adapters**, each 5 mm wide
- **aluminium lever**
- length 210 mm
- OLD: ≥ 130 mm
- **clamp width: 137 - 177 mm** (in 5 mm steps)
- on M-Wave eurohole card

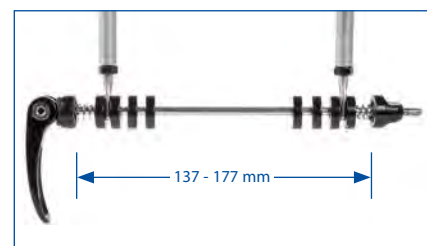

ART.-NR. UVP	BESCHREIBUNG	DESCRIPTION	
340250 8,90 €	EDELSTAHL-TRINKFLASCHE ›SBO 750‹ <ul style="list-style-type: none"> • 750 ml • aus Edelstahl • umweltschützend, da wiederverwendbar • mit Staubschutzkappenverschluss • mit Dichtungsring • frei von Schadstoffen • geruchs- und geschmacksneutral • auf M-Wave Eurolochkarte 	STAINLESS STEEL WATER BOTTLE ›SBO 750‹ <ul style="list-style-type: none"> • 750 ml • made of stainless steel • enviroment-friendly, because reusable • with protection cap • with sealing ring • free of contaminants • odorless and neutral in taste • on M-Wave eurohole card 	 <p>according to FDA</p>
340295 6,90 €	ALUMINIUM-TRINKFLASCHE ›ABO 750‹ <ul style="list-style-type: none"> • 750 ml • mit Staubschutzkappenverschluss • mit Dichtungsring • farbig sortiert • auf M-Wave Eurolochkarte 	ALUMINIUM WATER BOTTLE ›ABO 750‹ <ul style="list-style-type: none"> • 750 ml • with protection cap • with sealing ring • assorted colours • on M-Wave eurohole card 	 
	ISOLIER-/THERMOFLASCHE ›PBO 400-ISO‹ <ul style="list-style-type: none"> • 400 ml • aus transparentem Kunststoff • mit Isolierfolie • mit abnehmbarem Staubschutzkappenverschluss • auf M-Wave Eurolochkarte 	INSULATED/THERMO BOTTLE ›PBO 400-ISO‹ <ul style="list-style-type: none"> • 400 ml • made of transparent plastic • with insulating foil • with detachable protection cap • on M-Wave eurohole card 	 
340340	schwarz	black	
340346 8,90 €	gelb	yellow	
	ISOLIER-/THERMOFLASCHE ›PBO 500-ISO‹ <ul style="list-style-type: none"> • 500 ml • modernes Design • aus hochwertigem Kunststoff • leichte Entnahme von Isolierung und Innenbehälter zur Reinigung • mit Staubschutzkappe • auf M-Wave Eurolochkarte 	INSULATED/THERMO BOTTLE ›PBO 500-ISO‹ <ul style="list-style-type: none"> • 500 ml • modern design • high quality plastic • easy removal of insulation and inner container for cleaning • with protection cap • on M-Wave eurohole card 	  
340450	schwarz	black	
340452 7,90 €	weiß	white	

ART.-NR. BESCHREIBUNG
UVP

DESCRIPTION

340351 TRINKFLASCHE ›PBO 700-NS‹

WATER BOTTLE ›PBO 700-NS‹

6,90 €

- 700 ml
- mit **Anti-Rutsch**-Einlage
- aus hochwertigem Kunststoff
- abnehmbarer **Staubschutzkappenverschluss**
- silber/schwarz
- mit **Skala**
- auf M-Wave Eurolochkarte

- 700 ml
- with **non-slip** inlay
- high quality plastic
- detachable **protection cap**
- silver/black
- with **scale**
- on M-Wave eurohole card



TRINKFLASCHE ›PBO 600-NS‹

WATER BOTTLE ›PBO 600-NS‹

- 600 ml
- mit **Anti-Rutsch**-Einlage
- aus **hochwertigem** Kunststoff
- mit **Staubschutzkappenverschluss**
- auf M-Wave Eurolochkarte

- 600 ml
- with **non-slip** inlay
- **high quality** plastic
- with **protection cap**
- on M-Wave eurohole card



340365 weiß/schwarz

white/black

340366 silber/schwarz

silver/black

6,90 €



TRINKFLASCHE

WATER BOTTLE

- aus **hochwertigem Kunststoff**
- mit weichem **Big Flow Mundstück**
- auf M-Wave Eurolochkarte

- **high quality plastic**
- with soft **big flow bite valve**
- on M-Wave eurohole card



1.000 ml

›PBO 1000‹, 1.000 ml, mit Skala

›PBO 1000‹, 1,000 ml, with scale

340440 schwarz

black

340442 weiß

white

5,90 €

750 ml

›PBO 750‹, 750 ml, mit Skala

›PBO 750‹, 750 ml, with scale

340420 schwarz

black

340421 schwarz transparent

black transparent

340422 weiß

white

340423 transparent

transparent

340424 blau transparent

blue transparent

4,90 €



ART.-NR. UVP	BESCHREIBUNG	DESCRIPTION
-----------------	--------------	-------------

550 ml

›PBO 550‹, 550 ml, mit Skala

›PBO 550‹, 550 ml, with scale



- 340425 schwarz
 - 340426 schwarz transparent
 - 340427 weiß
 - 340428 transparent
 - 340429 blau transparent
- 3,90 €

- black
- black transparent
- white
- transparent
- blue transparent



350 ml

›PBO 350‹, 350 ml

›PBO 350‹, 350 ml



- 340430 schwarz
 - 340432 weiß
- 3,90 €

- black
- white



341020 **FLASCHENHALTER MIT MULTITOOL** ›BC 99 TOOL‹

32,90 €

99 g

- mit **integriertem Multitool** (9 Funktionen)
- Glasfaserverstärkter Kunststoff (GFK)
- **nur 99 g inkl. Multitool**
- inkl. Befestigungsschrauben
- auf M-Wave Eurolochkarte

BOTTLE CAGE WITH MULTITOOL ›BC 99 TOOL‹

- with **integrated multitool** (9 functions)
- fiberglass reinforced plastic
- **only 99 g incl. multitool**
- incl. fixing screws
- on M-Wave eurohole card



340908 **FLASCHENHALTER** ›BC 19-C‹

24,90 €

19 g

CARBON

- modernes und funktionelles Design
- **carbonfaserverstärkter** Kunststoff
- superleicht, nur **19 g**
- inkl. Befestigungsschrauben
- auf M-Wave Eurolochkarte

BOTTLE CAGE ›BC 19-C‹

- modern and functional design
- **carbon fiber** composite plastic
- super light, only **19 g**
- incl. fixing screws
- on M-Wave eurohole card



340707 **FLASCHENHALTER** ›BC 30-K‹

6,90 €

30 g

- modernes und funktionelles Design
- **hochwertiger Kunststoff**
- nur **30 g**
- **leichtes Herausnehmen und Einführen** der Flasche durch abgerundete Kanten
- inkl. Befestigungsschrauben
- auf M-Wave Eurolochkarte

BOTTLE CAGE ›BC 30-K‹

- modern and functional design
- **high quality plastic**
- only **30 g**
- **easy placement and removal** of the bottle by rounded brims
- incl. fixing screws
- on M-Wave eurohole card



ART.-NR. BESCHREIBUNG
UVP

DESCRIPTION

340720 FLASCHENHALTER ›BC VARIO SIDE‹

7,90 €



- **Montageadapter** ermöglicht **links-** wie auch **rechtsseitige** Einführung und Entnahme der Flasche. Dadurch besonders geeignet für **E-Bike Rahmengenometrien** mit eingeschränktem Platz
- **hochwertiger Kunststoff**
- nur 44 g
- **leichtes Herausnehmen und Einführen** der Flasche durch nach außen abgerundete Kanten
- universelle Passform
- inkl. Befestigungsschrauben
- auf M-Wave Eurolochkarte

BOTTLE CAGE ›BC VARIO SIDE‹

- **mounting adapter** enables the bottle to be placed and removed from the **left** and the **right side**. Therefore particularly suitable for **e-bike frame geometries** with limited space
- **high quality plastic**
- only 44 g
- **easy placement and removal** of the bottle by to the outside rounded brims
- universal fitting
- incl. fixing screws
- on M-Wave eurohole card



340916 FLASCHENHALTER ›BC 21‹

5,90 €



- hochwertiger Kunststoff
- nur **21 g**
- **leichtes** Herausnehmen und Einführen der Flasche durch abgerundete Kanten
- **gute Passform** durch flexible Seitenteile
- **Non-Slip** Gummieinlage erschwert das Herausfallen der Flasche
- auf M-Wave Eurolochkarte

BOTTLE CAGE ›BC 21‹

- high quality plastic
- only **21 g**
- **easy** placement and removal of the bottle through rounded brims
- **good fitting** because of flexible side parts
- **non-slip** rubber prevents the bottle from falling out
- on M-Wave eurohole card

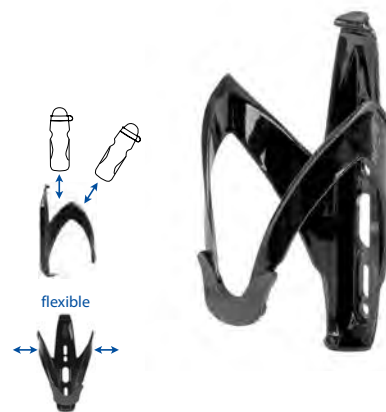

340790 FLASCHENHALTER ›BC VARIO‹

4,90 €

- fast **unzerstörbares**, hochwertiges, schwarzes Nylonmaterial
- Trinkflasche sowohl **von oben**, als auch **von vorne** einsteckbar
- inklusive 2 Befestigungsschrauben
- auf M-Wave Eurolochkarte

BOTTLE CAGE ›BC VARIO‹

- almost **indestructible**, high quality, black nylon
- water bottle can be put in **from top** or **front side**
- incl. 2 mounting screws
- on M-Wave eurohole card



340719 FLASCHENHALTER ›BC 33‹

4,90 €



- **hochwertiges**, schwarzes **Nylonmaterial**
- Flasche kann leicht von Rechts- und Linkshändern entnommen werden
- **flexible** und universelle Anpassung an verschiedene Flaschenformen
- leichtes **Einführen und Herausnehmen** der Flasche durch nach außen abgerundete Ränder
- nur **33 g**
- inkl. Befestigungsschrauben
- auf M-Wave Eurolochkarte

BOTTLE CAGE ›BC 33‹

- **high quality**, black **nylon**
- bottle can be easily taken out from right- and left-handers
- **flexible** and universal adaptation to different bottle forms
- outward chamfered edges make **placing and removing** of the bottle easier
- only **33 g**
- incl. fixing screws
- on M-Wave eurohole card



ART.-NR. BESCHREIBUNG
UVP

DESCRIPTION



FLASCHENHALTER

- besonders geeignet für **E-Bike Rahmengeometrien** mit eingeschränktem Platz
- nach außen gebogene Ränder **erleichtern** das Einführen der Flasche
- mit Befestigungsschrauben
- auf M-Wave Eurolochkarte

BOTTLE CAGE

- especially suitable for **e-bike frame geometries** with limited space
- outward chamfered edges **make it easier** to put in the bottle
- with mounting screws
- on M-Wave eurohole card



340051 ›BC 29 Side‹

- Flasche kann **auch von der Seite** leicht eingeführt und entnommen werden
- nur 29 g

›BC 29 Side‹

- bottle can be easily put in and taken away, also **from the side**
- only 29 g

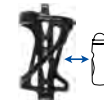

340053 ›BC 26 Side‹

3,90 €



- Flasche kann auch **schräg von der Seite** leicht eingeführt und entnommen werden
- nur 26 g

›BC 26 Side‹

- bottle can be easily put in and taken away, also **diagonal from the side**
- only 26 g



FLASCHENHALTER ›BC 47 A‹

- Aluminium
- nur **47 g**
- Flasche kann **leicht entnommen** werden
- **leichtes Einführen** der Flasche durch leicht nach außen gebogene Ränder
- inkl. Befestigungsschrauben
- auf M-Wave Eurolochkarte

BOTTLE CAGE ›BC 47 A‹

- aluminium
- only **47 g**
- bottle can be **easily taken away**
- outward chamfered edges make **placing the bottle easier**
- incl. fixing screws
- on M-Wave eurohole card



340884 schwarz

black

340889 silber

5,90 €

silver

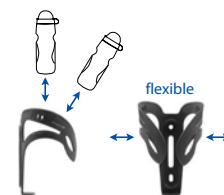

FLASCHENHALTER ›BC 54 A‹

- mit **Knopf** für **besseren Halt** und **Schutz** der Flasche
- nur 54 g
- inkl. Befestigungsschrauben
- auf M-Wave Eurolochkarte

BOTTLE CAGE ›BC 54 A‹

- with **knob** for **better fixation** and **protection** of the bottle
- only 54 g
- incl. fixing screws
- on M-Wave eurohole card



340965 schwarz

black

340966 silber

4,90 €

silver

ART.-NR. UVP **BESCHREIBUNG** **DESCRIPTION**

340018 FLASCHENHALTER ›BC 45‹

3,90 €

- Aluminium und hochwertiger Kunststoff
- nur 45 g
- guter Halt der Flasche durch **flexibles Rückenteil**
- mit Befestigungsschrauben
- auf M-Wave Eurolochkarte

BOTTLE CAGE ›BC 45‹

- aluminium and high quality plastic
- only 45 g
- good hold of the bottle due to **flexible back part**
- with mounting screws
- on M-Wave eurohole card



FLASCHENHALTER

- Aluminium
- mit **Knopf** für **besseren Halt** und **Schutz** der Flasche
- 6 mm
- Montageverpackung

340938 schwarz

340939 silber

3,90 €

BOTTLE CAGE

- aluminium
- with **knob** for **better fixation** and **protection** of the bottle
- 6 mm
- OEM

black

silver



FLASCHENHALTER

- Aluminium
- 6 mm
- Montageverpackung

340883 schwarz

340882 silber

340842 weiß

340843 rot

340844 blau

340845 grün

340847 orange/gold

340848 pink

3,90 €

BOTTLE CAGE

- aluminium
- 6 mm
- OEM

black

silver

white

red

blue

green

orange/gold

pink



340927 FLASCHENHALTER ›BC PET 500 A‹

5,90 €



- nur **31 g**
- passend auch für (PET)-Flaschen mit **500 ml** Volumen
- Durchmesser 64 - 66 mm
- schwarz
- auf M-Wave Eurolochkarte

BOTTLE CAGE ›BC PET 500 A‹

- only **31 g**
- also suitable for (PET) bottles with **500 ml** volume
- diameter 64 - 66 mm
- black
- on M-Wave eurohole card



FLASCHENHALTER ›BC 32 FLEX‹

- hochwertiger Kunststoff
- sehr **flexibel**, passt sich Flaschen von **0,33 l - 1,5 l** Volumen an
- nur **32 g**



340725 auf M-Wave Eurolochkarte

340726 Montageverpackung

3,90 €

BOTTLE CAGE ›BC 32 FLEX‹

- high quality plastic
- very **flexible**, suitable for bottles with **0.33 l up to 1.5 l** volume
- only **32 g**

on M-Wave eurohole card

OEM



ART.-NR. UVP **BESCHREIBUNG**

DESCRIPTION



FLASCHENHALTER ›BC 360◁

- hochwertiger, schwarzer Kunststoff
- mit **drehbarer Schelle**, werkzeuglose Montage am Rahmen, Lenkerbügel, ... mit **Schnellspanner** möglich (ca. Ø 16 - 32 mm)
- auch passend für die meisten 0,7 - 1,0 Liter Flaschen

340950 auf M-Wave Eurolochkarte

BOTTLE CAGE ›BC 360◁

- high grade, black plastic
- with **turnable clamp**, toolless mounting at the frame, handlebar, ... with **QR** (approx. Ø 16 - 32 mm)
- also suitable for the most 0.7 - 1.0 litre bottles

on M-Wave eurohole card



340951 Modell ›Eco◁
• im Polybeutel, ohne Logo
6,90

model ›Eco◁
• in PE bag, w/o logo

340150 BECHERHALTER ›TO GO◁

- 4,90 €
- **universell** passend für handelsübliche **Trinkflaschen, Kaffeebecher, ...**
 - mit Anti-Rutsch-Einlage
 - mit Befestigungsklemme für Ø 22,2 – 25,4 mm
 - aus Aluminium
 - auf M-Wave Eurolochkarte

CUPHOLDER ›TO GO◁

- **universally** suitable for customary **bottles, coffee mugs, ...**
- with non slip insole
- with fastening clamp for Ø 22.2 – 25.4 mm
- made of aluminium
- on M-Wave eurohole card



HALTER FÜR AIRTAG ›AIRCASE BC◁

- ermöglicht die **unauffällige Anbringung des Apple AirTag Senders unter dem Flaschenhalter**
- inkl. längerer Schrauben

245026 auf M-Wave Eurolochkarte

245025 Montageverpackung

14,90 €

BRACKET FOR AIRTAG ›AIRCASE BC◁

- enables the **Apple AirTag transmitter to be unobtrusively attached to the bottle cage**
- incl. extra long screws

on M-Wave eurohole card

OEM



340041 FLASCHENHALTER-ADAPTER ›ADA BC FLEX 2◁

- 7,90 €
- zur universellen Montage eines Flaschenhalters an unterschiedlichen Stellen, bei **verschiedensten Rahmengeometrien** oder bei eingeschränktem Platz an E-Bikes
 - schnelle und flexible **Montagemöglichkeiten durch non-slip Klettband**er (Art. 340042)
 - 1 Set = 1 Paar Adapter, 1 Paar Klettbander
 - auf M-Wave Eurolochkarte

BOTTLE CAGE ADAPTER ›ADA BC FLEX 2◁

- for universal mounting of a bottle cage at different places, at **most different frame geometries** or for e-bikes with little space for bottle cage mounting
- fast and flexible **mounting possibilities** by non-slip hook and loop fasteners (art. 340042)
- 1 set = 1 pair of adapters, 1 pair of hook and loop fasteners
- on M-Wave eurohole card



340042 UNIVERSALBEFESTIGUNGS-BAND

- 0,99 €
- Klettband
 - mit **Silikon-Antirutsch-Streifen**
 - Länge: 25 cm, Breite: 2 cm
 - Montageverpackung

UNIVERSAL MOUNTING TAPE

- hook and loop fastener
- with **silicone non-slip stripes**
- length: 25 cm, width: 2 cm
- OEM



340013 FLASCHENHALTER-ADAPTER ›ADA SLIDE◁

- 9,90 €
- zur optimalen Montage eines Flaschenhalters bei **verschiedensten Rahmengenometrien** oder bei eingeschränktem Platz an E-Bikes
 - **90 mm (+/- 45 mm) Verstellbereich** in der Höhe
 - aus Aluminium
 - inkl. Befestigungsmaterial
 - in M-Wave Eurolochbox

BOTTLE CAGE ADAPTER ›ADA SLIDE◁

- for optimal mounting of a bottle cage at **most different frame geometries** or for e-bikes with little space for bottle cage mounting
- **90 mm (+/- 45 mm) height adjustment range**
- made of aluminium
- incl. fixing material
- in M-Wave eurohole box

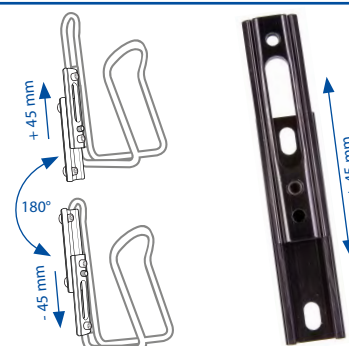

ART.-NR. UVP **BESCHREIBUNG**

DESCRIPTION

340015 FLASCHENHALTER-ADAPTER ›ADA TWO‹

7,90 €

- zur Befestigung von **2 Flaschenhaltern** an einer Flaschenhalteraufnahme
- **seitliche Befestigung** von Flaschenhaltern möglich, auch bei Rahmengeometrien mit **Platzproblemen**
- aus **Aluminium**
- nur **9 g**
- inkl. Befestigungsmaterial
- auf M-Wave Eurolochkarte

BOTTLE CAGE ADAPTER ›ADA TWO‹

- for assembling of **2 bottle cages** at one bottle cage eyelet
- bottle cages can be **sloped to the sides**, also for frame geometries that leave **little space** for bottle cages
- made of **aluminium**
- only **9 g**
- incl. fixing material
- on M-Wave eurohole card



340046 FLASCHENHALTER ADAPTER ›ADA S III‹

24,90 €

- zur Montage von zwei **Flaschenhaltern am Sattelgestell**
- zusätzliche **Stabilisierung großer Satteltaschen**, z. B. Art. 122630/6
- Aluminium
- stabile Klemmbefestigung
- auf M-Wave Eurolochkarte

BOTTLE CAGE ADAPTER ›ADA S III‹

- for mounting of two **bottle cages at the saddle rails**
- additional **stabilization of big saddle bags**, e. g. art. 122630/6
- aluminium
- stable clamp attachment
- on M-Wave eurohole card



340019 FLASCHENHALTER-ADAPTER ›ADA FLEX‹

7,90 €

360°

- zur Montage von **Flaschenhaltern an beliebigen Rohren** (z. B. Vorbau, Sitzrohr, Sattelstütze, Lenker, ...)
- mit **3 Nirosta-Halteschellen** für 19 - 22,4 mm, 22,4 - 27 mm und 28,6 - 31,8 mm Rohrdurchmesser
- mit **werkzeuglos abnehmbarem Halter**
- passend für **alle gängigen Flaschenhalter**
- auf M-Wave Eurolochkarte

BOTTLE CAGE ADAPTER ›ADA FLEX‹

- for assembling a **bottle cage at any tubes** (e. g. stem, seat tube, seat post, handlebar, ...)
- with **3 stainless steel clamps** for tube diameter 19 - 22.4 mm, 22.4 - 27 mm und 28.6 - 31.8 mm
- with **toolless disassembling bracket**
- usable for **all current bottle cages**
- on M-Wave eurohole card



340017 FLASCHENHALTER-ADAPTER ›ADA T90‹

4,90 €

90°

- zur Montage eines **Flaschenhalters am Lenker**, Sattelstütze, ...
- Aluminium
- für Lenkerdurchmesser 22,2 - 25,4 mm
- inkl. Edelstahlbefestigungsschrauben
- auf M-Wave Eurolochkarte

BOTTLE CAGE ADAPTER ›ADA T90‹

- for mounting of a **bottle cage at the handlebar**, seat post, ...
- aluminium
- for handlebar diameter 22.2 - 25.4 mm
- incl. stainless steel fixing screws
- on M-Wave eurohole card



122830 FLASCHENHALTER-TASCHE ›GRONINGEN BC‹

13,90 €

- inkl. Aluminium-Adapter zur Befestigung an den Flaschenhalterösen (unter dem Flaschenhalter)
- **wasserdicht**
- mit Innentasche für z. B. Kettenverschlussglieder, ...
- Tasche kann leicht (de-)montiert werden
- Adapter kann auch nur mit Klettbindern (z. B. Art. 340042) genutzt werden
- Größe: ca. 11,0 x 7,5 x 6,5 cm (L x B x H)
- auf M-Wave Eurolochkarte

BOTTLE CAGE BAG ›GRONINGEN BC‹

- incl. aluminium adapter for mounting to the bottle cage eyelets (below the bottle cage)
- **waterproof**
- with inner bag for e. g. chain links, ...
- bag can easily be (de-)mounted
- bracket can also be used only with hook and loop straps (e. g. art. 340042)
- size: approx. 11.0 x 7.5 x 6.5 cm (L x B x H)
- on M-Wave eurohole card



Bottles

ART.-NR. UVP **BESCHREIBUNG**

DESCRIPTION



KETTENRADGARNITUR

- 22/32/44 Zähne
- für 27 (und 24) Gang
- Stahl/Stahl/**Aluminium**kettenblätter, **auswechselbar**
- Lochkreis: 64 mm (22 Z.), 104 mm (32/44 Z.)
- JIS
- Innenlagerlänge: 119 mm
- Montageverpackung

351234 • **polierte Aluminiumkurbel**
AD
• Kurbellänge: 170 mm

351235 • **schwarze Kurbel**
AD
37,90 € / set
mAD 55,90 € / set
• Kurbellänge: **175 mm**
• schwarzes Kettenblatt, 44 Zähne

CHAINWHEEL SET

- 22/32/44 teeth
- for 27 (and 24) speed
- steel/steel/**aluminium** chainrings, **re-placeable**
- bolt circle: 64 mm (22 t.), 104 mm (32/44 t.)
- JIS
- B.B. set length: 119 mm
- OEM

• **polished aluminium crank**
• crank length: 170 mm

• **black crank**
• crank length: **175 mm**
• black chainring, 44 teeth

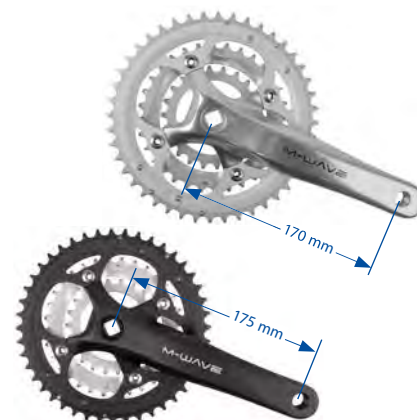

Tested by the manufacturer based on ISO 4210



KETTENRADGARNITUR

- **22/32/42** Zähne
- für 24 (und 21) Gang
- **polierte Aluminiumkurbel**
- Kurbellänge: 170 mm
- JIS
- **silberne, auswechselbare Stahlkettenblätter**
- Lochkreis: 64 mm
- Innenlagerlänge: 107 mm
- Montageverpackung

351236 ohne Kettenschutz
AD
27,00 € / set
mAD 38,90 € / set

351237 mit Kettenschutz
AD
27,90 € / set
mAD 39,90 € / set

CHAINWHEEL SET

- **22/32/42** teeth
- for 24 (and 21) speed
- **polished aluminium crank**
- crank length: 170 mm
- JIS
- **silver, replaceable steel chainrings**
- bolt circle: 64 mm
- B.B. set length: 107 mm
- OEM

without chainguard

with chainguard



Tested by the manufacturer based on ISO 4210

351240 KETTENRADGARNITUR

AD
29,90 € / set
mAD 43,90 € / set

- **26/38/48** Zähne
- für 24 (und 21) Gang
- **polierte Aluminiumkurbel**
- Kurbellänge: 170 mm
- JIS
- **silberne, auswechselbare Stahlkettenblätter**
- mit transparentem Kettenschutz
- Lochkreis: 64 mm
- Innenlagerlänge: 107 mm
- Montageverpackung

CHAINWHEEL SET

- **26/38/48** teeth
- for 24 (and 21) speed
- **polished aluminium crank**
- crank length: 170 mm
- JIS
- **silver, replaceable steel chainrings**
- with transparent chainguard
- bolt circle: 64 mm
- B.B. set length: 107 mm
- OEM



Tested by the manufacturer based on ISO 4210



KETTENRADGARNITUR

- polierte **Aluminiumkurbel**
- schwarzes, **austauschbares CNC gefrästes Aluminium** Kettenblatt
- Lochkreis: 130 mm
- Kurbellänge: 165 mm
- JIS
- 1/2" x 1/8"
- Kettenlinie: 45 mm
- Innenlagerlänge: 110,5 mm
- silber/schwarz
- Montageverpackung

350630 **46 Zähne**
AD

350640 **44 Zähne**
AD
35,90 € / set
mAD 52,90 € / set

CHAINWHEEL SET

- polished **aluminium crank**
- black, **replaceable CNC-machined aluminium** chainring
- bolt circle: 130 mm
- crank length: 165 mm
- JIS
- 1/2" x 1/8"
- chain line: 45 mm
- B.B. set length: 110.5 mm
- silver/black
- OEM



Tested by the manufacturer based on ISO 4210

ART.-NR. UVP **BESCHREIBUNG** **DESCRIPTION**

KETTENRADGARNITUR

- geschmiedete, polierte **Aluminiumkurbel**
- Kurbellänge: 170 mm
- JIS
- silbernes Stahlkettenblatt
- 1/2" x 3/32"
- Innenlagerlänge: 131 mm
- Montageverpackung

CHAINWHEEL SET

- forged, polished **aluminium crank**
- crank length: 170 mm
- JIS
- silver steel chainring
- 1/2" x 3/32"
- B.B. set length: 131 mm
- OEM



350650 46 Zähne
AD

46 teeth

350651 44 Zähne
AD

44 teeth

350652 38 Zähne
AD

38 teeth

350653 33 Zähne
AD

33 teeth

17,90 € / set
mAD 25,90 € / set

Tested by the manufacturer based on ISO 4210

KURBELENDSCHUTZ
›CRANK BOOTS‹

- zum **Schutz gegen Steinschlag, Verkratzen, ...**
- **schlagfestes und langlebiges** Material
- leichte und schnelle Montage
- auf M-Wave Eurolochkarte

CRANK PROTECTION
›CRANK BOOTS‹

- **protection against stone chipping, scratching, ...**
- **impact resistant and durable** material
- easy and fast mounting
- on M-Wave eurohole card



352730 schwarz

black

352731 rot

red

4,90 € / pair

KETTENSCHUTZ ›CHAIN CAGE‹

- **Clip-on Ketten- und Hosenschutz für 1/2" x 1/8" Ketten** ohne Schaltwerk
- wird direkt auf die Kette montiert, muss nicht am Rad befestigt werden
- **werkzeuglose** und schnelle **Montage**
- geräuschreduziert
- 120 Glieder
- im M-Wave Eurolochbox

CHAINSLIDER ›CHAIN CAGE‹

- **clip-on chain and trousers protection**
- **for 1/2" x 1/8" chains** w/o rear derailleur
- mounted directly on the chain, no need to be fixed at the bike
- **toolless** and quick **mounting**
- noise reduced
- 120 links
- in M-Wave eurohole box



352654 16,90 €



Chainwheel Sets



KETTENSCHUTZSCHEIBE

- **verschiedene Befestigungsmöglichkeiten:**
- am **Gewinde** für Staubschutzkappe
- **Konusbefestigung (Hollowtech II)**
- aus Kunststoff
- schwarz
- inkl. Befestigungsmaterial
- Montageverpackung

CHAINGUARD

- **multiple mounting positions:**
- **at dust cap thread**
- **cone fixation (Hollowtech II)**
- made of plastic
- black
- incl. mounting material
- OEM



352648 42 - 44 Zähne

42 - 44 teeth

352649 46 - 48 Zähne

46 - 48 teeth

5,90 €

ART.-NR. BESCHREIBUNG
UVP

DESCRIPTION



BSA KOMPAKT-INNENLAGER FÜR SHIMANO WERKZEUG ›CAROUSEL BB BSA SQ‹

- **CrMo-Hohlachse, Dacromet** beschichtet
- **Aluminiumschalen mit Lockseal**
- nur **218 g** (107,5 mm)
- im M-Wave Karton

L1 / L2

359450	107,5/20,5 mm
359451	110,5/20,5 mm
359452	113,5/23 mm
359453	115/24 mm
359454	119/27 mm
359455	122,5/28,5 mm
359456	127,5/31 mm
359457	131/34 mm

13,90 €

BSA CARTRIDGE B.B. SET FOR SHIMANO TOOL ›CAROUSEL BB BSA SQ‹

- **CrMo hollow axle, Dacromet** coated
- **aluminium cups with lockseal**
- only **218 g** (107.5 mm)
- in M-Wave box

L1 / L2

107.5/20.5 mm
110.5/20.5 mm
113.5/23 mm
115/24 mm
119/27 mm
122.5/28.5 mm
127.5/31 mm
131/34 mm



FAT BIKE INNENLAGER ›CAROUSEL BB BSA SQ FAT‹

- **silberne, Dacromet** beschichtete Achse
- silberne Schalen
- rostschutzbeschichtete Achsschrauben mit **Dichtungsring** und Lockseal
- im **M-Wave** Einzelkarton

359438 • für **120 mm** Innenlagergehäuse
• L1: 179,5 mm, L2: 28,7 mm (mit Adapterring (2,5 mm) auf 31,2 mm verlängerbar)

359439 • für **100 mm** Innenlagergehäuse
• L1: 159,5 mm, L2: 25,5 mm

11,90 €

FAT BIKE BOTTOM BRACKET ›CAROUSEL BB BSA SQ FAT‹

- **silver, Dacromet** coated axle
- silver cups
- antirust coated axle bolts with **sealing ring** and lockseal
- in **M-Wave** box

• for **120 mm** bottom bracket housing
• L1: 179.5 mm, L2: 28.7 mm (with adaptor ring (2.5 mm) extendable to 31.2 mm)

• for **100 mm** bottom bracket housing
• L1: 159.5 mm, L2: 25.5 mm

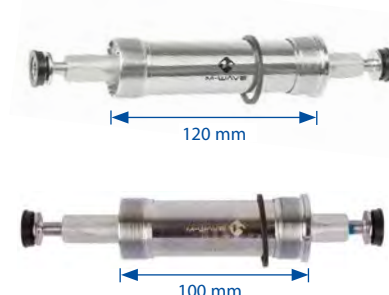

KOMPAKT REPARATUR-INNENLAGER

- geeignet für **BSA-** und **italienisches** Tretlagergehäuse
- auch für **defekte Gewinde** geeignet
- passend für Shimano-Werkzeug
- mit verchromten Stahlschalen
- gedichtete **Industriekugellager**
- mit Achsschrauben
- im M-Wave Einzelkarton

›CAROUSEL BB REPAIR‹

359470 L1: 113 mm

359471 L1: 119 mm

359472 L1: 122,5 mm

359473 L1: 127 mm

359475 **›CAROUSEL BB REPAIR COTTER‹**

- L1: 136 mm
- Montage durch Kurbelkeile

12,90 €

REPAIR BOTTOM BRACKET

- suitable for **BSA** and **Italian** bottom bracket housing
- also suitable for **defective threads**
- suitable for Shimano tool
- with c. p. steel cups
- **sealed bearings**
- with axle bolts
- in M-Wave box

›CAROUSEL BB REPAIR‹

L1: 113 mm

L1: 119 mm

L1: 122.5 mm

L1: 127 mm

›CAROUSEL BB REPAIR COTTER‹

- L1: 136 mm
- mounting by crank cotter pins

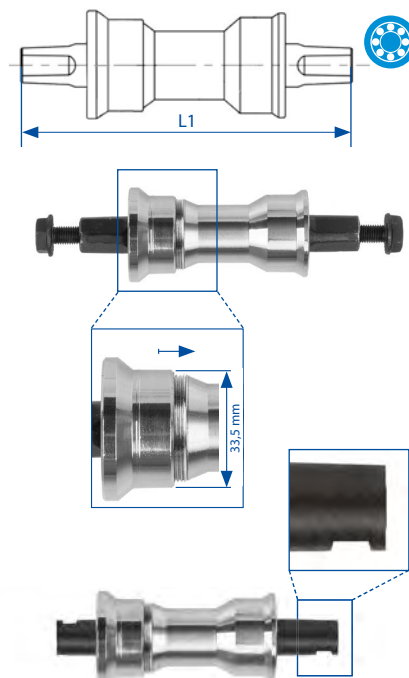

ART.-NR. UVP
BESCHREIBUNG

DESCRIPTION



GEWINDE-INNENLAGER

- **außenliegende, CNC-gefräste Aluminium-Lagerschalen**
- **2 Industriekugellager**
- für 68-73 mm Gehäusebreite, inkl. Spacer
- im M-Wave Einzelkarton

359430 ›CAROUSEL BB BSA EX JPN‹

- **Shimano** kompatibel (kein original Shimano Ersatzteil)
- Innen-Ø 24 mm
- nur 90 g

359432 ›CAROUSEL BB BSA EX US‹

- 16,90 €
- **Sram** kompatibel (kein original Sram Ersatzteil)
 - Innen-Ø 24/22 mm
 - nur 94 g

THREADED BOTTOM BRACKET

- **outer, CNC machined aluminium bearing cups**
- **2 sealed bearings**
- for 68-73 mm b.b. housing width, incl. spacer
- in M-Wave box

›CAROUSEL BB BSA EX JPN‹

- compatible with **Shimano** (no original Shimano spare part)
- inner Ø 24 mm
- only 90 g

›CAROUSEL BB BSA EX US‹

- kompatibel with **Sram** (no original Sram spare part)
- inner Ø 24/22 mm
- only 94 g



Tested by the manufacturer based on ISO 4210

359435 PRESSFIT-INNENLAGER

16,90 €



›CAROUSEL BB PF EX‹

- **innenliegende, CNC-gefräste Aluminium-Lagerschalen zum Einpressen**
- **2 Industriekugellager**
- für **Shimano Hollowtech II** Tretlager (kein original Shimano Ersatzteil)
- Außen-Ø 41 mm/Innen-Ø 24 mm
- **universell passend** für Rennrad 86,5 mm und MTB 89,5/92 mm Breite
- mit wasserabweisender Kunststoff-Innenhülse
- inkl. **Adapterring 2,0 mm**
- nur **94 g**
- im M-Wave Einzelkarton



PRESS FIT BOTTOM BRACKET

›CAROUSEL BB PF EX‹

- **inner, CNC machined aluminium press fit bearing cups**
- **2 sealed bearings**
- for **Shimano Hollowtech II** cranksets (no original Shimano spare part)
- outer Ø 41 mm/inner Ø 24 mm
- **universally useable** for road 86.5 mm and MTB 89.5/92 mm width
- with water-repellent plastic inner casing
- incl. **adaptor ring 2.0 mm**
- only **94 g**
- in M-Wave box



86,5 - 92 mm

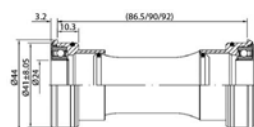

Tested by the manufacturer based on ISO 4210

SCHEIBENBREMSE HYDRAULISCH ›DBH-2‹

- **2-Kolben-Bremse**
- kompakte Bauweise
- für Mineralöl
- **kaltgeschmiedetes Aluminium**
- **selbstjustierende Kolben**
- **Griffweite einstellbar**
- mit kürzbarer Hydraulikleitung, Ø 5 mm
- mit Ersatzpin und Olive
- für Postmount System
- Montageverpackung

360718 • für **VR**
• 900 mm Leitung

360719 • für **HR**
• 1.600 mm Leitung

41,90 €
mAD 61,90 €

DISC BRAKE HYDRAULIC ›DBH-2‹

- **Dual Piston brake**
- compact construction
- for mineral oil
- **cold forged aluminium**
- **self-adjusting pistons**
- **adjustable reach**
- hydraulic hose can be shortened, Ø 5 mm
- with replacement pin and olive
- for postmount system
- OEM

• for **front**
• 900 mm tube

• for **rear**
• with 1,600 mm tube



360692 WARTUNGSSET FÜR SCHEIBENBREMSEN ›BLEEDBOX‹

35,90 €

- 2 x Spritze 25 ml
- 2 x M5 Adapter
- 2 x M6 Adapter
- 2 x O-Ring für DOT 4 Bremsflüssigkeit
- 2 x O-Ring für Mineralöl
- Leitungsschneider
- Entlüftungs-Distanzstück (für Promax-Scheibenbremsen)
- im M-Wave Einzelkarton

BLEEDING KIT FOR DISC BRAKES ›BLEEDBOX‹

- 2 x syringe 25 ml
- 2 x M5 adapter
- 2 x M6 adapter
- 2 x O-ring for DOT 4 brake liquid
- 2 x O-ring for mineral oil
- tube cutter
- bleed block (for Promax disc brakes)
- in M-Wave box



ART.-NR. UVP	BESCHREIBUNG	DESCRIPTION
-----------------	--------------	-------------

360691 **WARTUNGSSET FÜR HYDRAULISCHE SCHEIBEN-BREMSEN ›BRAKE DOC BOX‹**
143,00 €

- passend für
 - Shimano** Deore XT 2005 - 2007 / 2009-2013 / 2016, Deore LX 2009 - 2013, Deore 2009 - 2013, XTR 2009 - 2013 / 2014 - 2015 / 2016
 - Hayes** Stroker Trail, Stroker Carbon, Stroker Ace, Stroker Gram, El Camino
 - Tektro** Auriga Pro, Auriga SUB, Auriga Comp, Auriga Comp WS
 - Magura** Louise, Louise FR und Marta
 - Avid** Juicy 5/7 und Ultimate
 - Bengal** Helix 1.0/1.1, Helix 3 5 L, Helix 3 Carbon
- zwei Spritzen (30 ml und 10 ml)
- Schlauch-Adapter (4/5/6 mm) und Überwurfmutter
- Bremsflüssigkeit DOT 5.1
- in M-Wave Aufbewahrungsbox

BLEEDING KIT FOR HYDRAULIC DISC BRAKE ›BRAKE DOC BOX‹

- suitable for
 - Shimano** Deore XT 2005 - 2007 / 2009 - 2013 / 2016, Deore LX 2009 - 2013, Deore 2009 - 2013, XTR 2009 - 2013 / 2014 - 2015 / 2016
 - Hayes** Stroker Trail, Stroker Carbon, Stroker Ace, Stroker Gram, El Camino
 - Tektro** Auriga Pro, Auriga SUB, Auriga Comp, Auriga Comp WS
 - Magura** Louise, Louise FR and Marta
 - Avid** Juicy 5/7 and Ultimate
 - Bengal** Helix 1.0/1.1, Helix 3 5 L, Helix 3 Carbon
- two syringes (30 ml and 10 ml)
- adapters (4/5/6 mm) and swivel nuts
- brake liquid DOT 5.1
- in M-Wave storage box



<p>Shimano® Deore XT 2005-2007 XTR 2014-2015</p>  <p>5x</p>	<p>Shimano® Deore XT 2016 XTR 2016</p>  <p>5x</p>	<p>Tektro® Auriga Pro Auriga SUB Auriga Comp Auriga Comp WS</p>  <p>8x</p>	<p>Magura® Louise Louise FR Marta</p>  <p>4x</p>	<p>Bengal® Helix 1.0/1.1 Helix 3 5 L Helix 3 carbon</p>  <p>3x</p>	<p>Hayes® Stroker Trail Stroker Carbon Stroker Ace Stroker Gram El Camino</p>  <p>4x</p>	<p>Avid® Juicy 5/7 Ultimate</p>  <p>1x</p>	 <p>1x</p>	 <p>1x</p>
<p>Shimano® Deore XT 2009-2013 Deore LX 2009-2013 Deore 2009-2013 XTR 2009-2013</p>  <p>8x</p>	<p>Überwurfmutter/ swivel nut für/for Shimano® für/for Avid® für/for Sram®</p>  <p>5x</p>	<p>Überwurfmutter/ swivel nut für/for Hayes® für/for Tektro®</p>  <p>5x</p>	<p>Schlauch-Adapter/ adapter for hose fitting 4mm 5mm 6mm</p>  <p>2x</p>	<p>Bremsflüssigkeit DOT 5.1/ brake fluid DOT 5.1</p>  <p>1x</p>	 <p>2x</p>			

BREMSFLÜSSIGKEIT
für hydraulische (Brems-)Systeme
(z. B. für Scheibenbremsen von Fahrrädern)

BRAKE LIQUID
for hydraulic (brake) systems
(e. g. for bicycle disc brakes)

Dot 5.1

Dot 5.1

365900 100 ml Flasche
6,90 €

100 ml bottle

365901 1 l Kanister
29,90 €

1 l canister



Mineralöl

Mineral oil

365902 100 ml Flasche
5,90 €

100 ml bottle

365903 1 l Kanister
19,90 €

1 l canister



ART.-NR. UVP **BESCHREIBUNG**

DESCRIPTION

SCHEIBENBREMSADAPTER

für die Verwendung von Postmount Bremskörpern mit größerer / kleinerer Bremsscheibe, sowie zur Montage an IS2000-Aufnahmen.

Passend für alle gängigen Postmount Bremskörper mit 6" Befestigungsschraubenabstand

*Postmount-Adapter (Art. 360626-9) inkl. Befestigungsschrauben für Postmount.

ADAPTER FOR DISC BRAKE

for the use of postmount brake calipers with larger / smaller brake disc and for mounting to IS2000 base.

Suitable for all common postmount brake calipers with 6" mounting screw distance.

*postmount adapters (art. 360626-9) incl. mounting screws for postmount.

Tested by the manufacturer based on ISO 4210

Montagesockel / assembly base			Ø Bremsscheibe / disc			
			140 mm	160 mm	180 mm	203 mm
IS 2000	vorne / front	AM		360621	360623	360631
		OEM		360620	360622	360630
	hinten / rear	AM		360623	360625	
		OEM		360622	360624	
Postmount	vorne / front	AM			360627*	360629*
		OEM			360626*	360628*
	hinten / rear	AM			360627*	360629*
		OEM			360626*	360628*
Flatmount	vorne / front	AM	360434	360435		
		OEM	360430	360431		
	hinten / rear	AM	360436	360437		
		OEM	360432	360433		

7,90 €



CENTERLOCK ADAPTER FÜR BREMSSCHEIBEN ›ADA DB CL‹

- ermöglicht die Montage von **6-Loch Bremsscheiben** auf **Center Lock Naben**
- CNC gefrästes Aluminium

CENTER LOCK ADAPTER FOR BRAKE DISCS ›ADA DB CL‹

- allows the mounting of **6-hole brake discs** on **Center Lock hubs**
- CNC machined aluminium



361120 Montageverpackung





OEM

361121 auf M-Wave Eurolochkarte

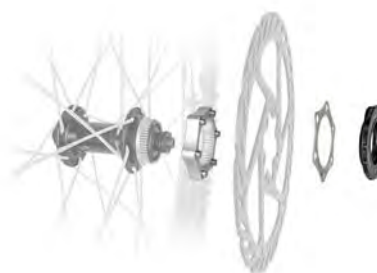
on M-Wave eurohole card

16,90 €

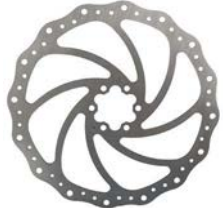

ART.-NR. UVP	BESCHREIBUNG	DESCRIPTION	
	BREMSSCHEIBE	BRAKE DISC	
	<ul style="list-style-type: none"> • Edelstahl • inkl. Befestigungsschrauben 	<ul style="list-style-type: none"> • stainless steel • incl. fixing screws 	
	›BD-140‹, 140 mm	›BD-140‹, 140 mm	
360645 11,90 € / set	in M-Wave Verpackung	in M-Wave packaging	
360643 11,90 € / set	Montageverpackung	OEM	
	›BD-160‹, 160 mm	›BD-160‹, 160 mm	
360634 11,90 € / set	in M-Wave Verpackung	in M-Wave packaging	
360600 11,90 € / set	Montageverpackung	OEM	
	›BD-180‹, 180 mm	›BD-180‹, 180 mm	
360633 12,90 € / set	in M-Wave Verpackung	in M-Wave packaging	
360606 12,90 € / set	Montageverpackung	OEM	
	›BD-203‹, 203 mm	›BD-203‹, 203 mm	
360644 12,90 € / set	in M-Wave Verpackung	in M-Wave packaging	
360641 12,90 € / set	Montageverpackung	OEM	



BREMSBELÄGE

- **organische Bremsbeläge**
- **Bremskraft gut dosierbar, Hitze isolierend** und leiser
- 1 Paar in M-Wave Blisterverpackung

Mit Hilfe der **1:1 Abbildungen** finden Sie schnell und einfach die richtigen Beläge.

BRAKE PADS

- **organic brake pads**
- **precisely controlled braking power, heat insulating** and quieter
- 1 pair in M-Wave blister packaging

With the help of **1:1 figures**, you find fast and easily the right pads.

SHIMANO

Tested by the manufacturer based on ISO 4210

für **Shimano** XTR: BR-M9000/20, BR-M987/5, XT: BR-M785, SLX: BR-M675/66, Deore: BR-M615, Alfine: BR-S700, Rennrad: BR-R785, BR-RS785, mit Nirosta Ersatz-Clip

for **Shimano** XTR: BR-M9000/20, BR-M987/5, XT: BR-M785, SLX: BR-M675/66, Deore: BR-M615, Alfine: BR-S700, racing: BR-R785, BR-RS785, with stainless steel replacement clip

360744 ›BPD Organic S1‹, organisch

›BPD Organic S1‹, organic

360762 ›BPD Metal S1‹, gesintert
200/10 pair

›BPD Metal S1‹, sintered



für **Shimano** XTR: BR-M 965/6/75, XT: BR-M 765, SLX: BR-M605/85, LX: (BR-M 585/95, Deore: BR-M 535, Saint: BR-M 800, T665, Hone: BR-M 601, für **Tektro** TRP Dash mit Nirosta Ersatz-Clip

for **Shimano** XTR: BR-M 965/6/75, XT: BR-M 765, SLX: BR-M605/85, LX: (BR-M 585/95, Deore: BR-M 535, Saint: BR-M 800, T665, Hone: BR-M 601, for **Tektro** TRP Dash, with stainless steel replacement pin

360757 ›BPD Organic ST1‹, organisch
9,90 € / pair

›BPD Organic ST1‹, organic



ART.-NR. BESCHREIBUNG
UVP

DESCRIPTION

SHIMANO

für **Shimano** BR-C501, BR-M575, BR-M525, BR-M495, BR-M486, BR-M485, BR-M475, BR-M465, BR-M447, BR-M446, BR-M445, BR-M416, BR-M416A, BR-M415, BR-M395, BR-M375, BR-T675, BR-T615, ..., für **Tektro** Auriga Pro, Auriga E-Comp, Auriga Comp, Aquila, Draco WS, Dorado, Orion, Gemini, Draco 2, TRP HY/RD, Spyre, Hywire, Parabox R, Parabox 2012 ..., für **Promax** DSK-909, für **Flatmount** (Art. 360411), mit Nirosta Ersatz-Clip

for **Shimano** BR-C501, BR-M575, BR-M525, BR-M495, BR-M486, BR-M485, BR-M475, BR-M465, BR-M447, BR-M446, BR-M445, BR-M416, BR-M416A, BR-M415, BR-M395, BR-M375, BR-T675, BR-T615, ..., for **Tektro** Auriga Pro, Auriga E-Comp, Auriga Comp, Aquila, Draco WS, Dorado, Orion, Gemini, Draco 2, TRP HY/RD, Spyre, Hywire, Parabox R, Parabox 2012 ..., for **Promax** DSK-909, for **flatmount** (art. 360411), with stainless steel replacement pin

360746 ›BPD Organic STP1‹, organisch

›BPD Organic STP1‹, organic

360764 ›BPD Metal STP1‹, gesintert

›BPD Metal STP1‹, sintered

9,90 € / pair



sintered

für **Shimano** Saint BR-M810/20, ZEE BR-M640, mit Nirosta Ersatz-Clip

for **Shimano** Saint BR-M810/20, ZEE BR-M640, with stainless steel replacement pin

360745 ›BPD Organic S2‹, organisch

›BPD Organic S2‹, organic

360763 ›BPD Metal S2‹, gesintert

›BPD Metal S2‹, sintered

9,90 € / pair



sintered

MAGURA

Tested by the manufacturer based on ISO 4210

für **Magura** MT Serie MT2/4/6/8

for **Magura** MT Serie MT2/4/6/8

360749 ›BPD Organic M1‹, organisch

›BPD Organic M1‹, organic

9,90 € / pair



HAYES

für **Hayes** HFX-9, MAG, MX-1, mit Nirosta Ersatzfeder

for **Hayes** HFX-9, MAG, MX-1, with stainless steel replacement pin

360754 ›BPD Organic H2‹, organisch

›BPD Organic H2‹, organic

9,90 € / pair



ART.-NR. UVP	BESCHREIBUNG	DESCRIPTION
-----------------	--------------	-------------

HAYES

für **Hayes** MX 2/3/Sole
für **Promax** DSK-810

for **Hayes** MX 2/3/Sole
for **Promax** DSK-810

360756 ›BPD Organic HP1‹, organisch
9,90 € / pair

›BPD Organic HP1‹, organic



UVP 9,90 €

TEKTRO

für **Tektro** Auriga Pro, Auriga E-Comp, Auriga Comp, Aquila, Draco WS, Dorado, Orion, Gemini, Draco 2, TRP HY/RD, Spyre, Hywire, Parabox R, Parabox 2012 ...,
für **Shimano** BR-C501, BR-M575, BR-M525, BR-M495, BR-M486, BR-M485, BR-M475, BR-M465, BR-M447, BR-M446, BR-M445, BR-M416, BR-M416A, BR-M415, BR-M395, BR-M375, BR-T675, BR-T615, ...,
für **Promax** DSK-909,
für **Flatmount** (Art. 360411),
mit Nirosta Ersatz-Clip

for **Tektro** Auriga Pro, Auriga E-Comp, Auriga Comp, Aquila, Draco WS, Dorado, Orion, Gemini, Draco 2, TRP HY/RD, Spyre, Hywire, Parabox R, Parabox 2012 ...,
for **Shimano** BR-C501, BR-M575, BR-M525, BR-M495, BR-M486, BR-M485, BR-M475, BR-M465, BR-M447, BR-M446, BR-M445, BR-M416, BR-M416A, BR-M415, BR-M395, BR-M375, BR-T675, BR-T615, ...,
for **Promax** DSK-909,
for **flatmount** (art. 360411),
with stainless steel replacement pin

360746 ›BPD Organic STP1‹, organisch

›BPD Organic STP1‹, organic



360764 ›BPD Metal STP1‹, gesintert
9,90 € / pair

›BPD Metal STP1‹, sintered



für **Tektro** TRP Dash,
für **Shimano** XTR: BR-M 965/6/75, XT: BR-M 765, SLX: BR-M605/85, LX: BR-M 585/95, Deore: BR-M 535, Saint: BR-M 800, T665, Hone: BR-M 601,
mit Nirosta Ersatz-Clip

for **Tektro** TRP Dash,
for **Shimano** XTR: BR-M 965/6/75, XT: BR-M 765, SLX: BR-M605/85, LX: BR-M 585/95, Deore: BR-M 535, Saint: BR-M 800, T665, Hone: BR-M 601,
with stainless steel replacement pin

360757 ›BPD Organic ST1‹, organisch
9,90 € / pair

›BPD Organic ST1‹, organic



ART.-NR. BESCHREIBUNG
UVP

DESCRIPTION

Tested by the manufacturer
based on ISO 4210

SRAM/AVID

für **Sram/Avid** Elixir XX, XO, DB,
mit Nirosta Ersatz-Clip

for **Sram/Avid** Elixir, XX, XO, DB,
with stainless steel replacement clip

360740 ›BPD Organic AS1‹, organisch

›BPD Organic AS1‹, organic



360761 ›BPD Metal AS1‹, gesintert
9,90 € / pair

›BPD Metal AS1‹ sintered



für **Sram/Avid** Code,
mit Nirosta Ersatz-Clip

for **Sram/Avid** Code,
with stainless steel replacement clip

360743 ›BPD Organic AS2‹, organisch
9,90 € / pair

›BPD Organic AS2‹, organic



für **Sram/Avid** BB7, Juicy 5/7
für **Promax** Q3, DSK-905
mit Nirosta Ersatz-Clip

for **Sram/Avid** BB7, Juicy 5/7
for **Promax** Q3, DSK-905
with stainless steel replacement clip

360742 ›BPD Organic ASP1‹, organisch
200/10 pair

›BPD Organic ASP1‹, organic



ART.-NR. BESCHREIBUNG
UVP

DESCRIPTION

SRAM/AVID

Tested by the manufacturer based on ISO 4210

für **Sram X0 Trail/Guide**, mit Nirosta Ersatz-Clip

for **Sram X0 Trail/Guide**, with stainless steel replacement clip

360741 ›BPD Organic S3‹, organisch
9,90 € / pair

›BPD Organic S3‹, organic



für **Sram Red**, SRAM RED 22 B1, FORCE 22/CX1 RIVAL 22 700 B1 HRD/HRR,

for **Sram Red**, SRAM RED 22 B1, FORCE 22/CX1 RIVAL 22 700 B1 HRD/HRR,

360758 ›BPD Organic SR1‹, organisch
9,90 € / pair

›BPD Organic SR1‹, organic



361742 **CARTRIDGE V-BREMSSCHUHE** ›BPR-VC-BASE-ALU‹

8,90 € / pair

- **Aluminium**-Bremsschuhe mit austauschbaren Bremsgummis
- Länge: 72 mm
- für V-Bremsen
- für trockene und nasse Verhältnisse
- für alle Stahl- und Aluminiumfelgen
- paarweise auf M-Wave Eurolochkarte

CARTRIDGE V-BRAKE SHOES ›BPR-VC-BASE-ALU‹

- **aluminium** brake shoes with replaceable brake rubbers
- length: 72 mm
- for V-brakes
- for dry and wet conditions
- for all steel- and aluminium rims
- 1 pair on M-Wave eurohole card



361771 **BREMSSCHUH-ERSATZBELAG** / pair ›BPR-INSERT-VC‹

2,90 € / pair

- passend für Art. 361742, ...
- mit **Nirosta**-Stift
- paarweise auf M-Wave Eurolochkarte

BRAKE SHOE REPLACEMENT RUBBER ›BPR-INSERT-VC‹

- suitable for art. 361742, ...
- with **stainless** pin
- 1 pair on M-Wave eurohole card



Tested by the manufacturer based on ISO 4210

361021 **V-BREMSSCHUHE** ›BPR-VC-DUAL‹

4,90 € / pair

- mit **2-farbigen** Bremsgummis: **2 Farben = 2 Funktionen durch 2 Profile:** **schwarz** = starke Bremswirkung **rot** = Wasserverdrängung
- Länge: 72 mm
- für V-Bremsen
- für trockene und nasse Verhältnisse
- für alle Stahl- und Aluminiumfelgen
- Bolzen mit Gewinde und Befestigungsmaterial
- paarweise auf M-Wave Eurolochkarte

V-BRAKE SHOES ›BPR-VC-DUAL‹

- with **2 coloured** brake shoes
- **2 colours = 2 functions through 2 profiles:** **black** = extra grip **red** = water displacement
- length: 72 mm
- for V-brakes
- for dry and wet conditions
- for all steel- and aluminium rims
- bolt with thread and mounting material
- 1 pair on M-Wave eurohole card



ART.-NR. UVP	BESCHREIBUNG	DESCRIPTION
-----------------	--------------	-------------

361020 2,90 € / pair	V-BREMSSCHUHE ›BPR-VC-BASE‹	V-BRAKE SHOES ›BPR-VC-BASE‹
	<ul style="list-style-type: none"> • Länge: 72 mm • für V-Bremsen • für trockene und nasse Verhältnisse • für alle Stahl- und Aluminiumfelgen • Bolzen mit Gewinde und Befestigungsmaterial • paarweise auf M-Wave Eurolochkarte 	<ul style="list-style-type: none"> • length: 72 mm • for V-brakes • for dry and wet conditions • for all steel- and aluminium rims • bolt with thread and mounting material • 1 pair on M-Wave eurohole card

Tested by the manufacturer based on ISO 4210



361024 59,90 € / set	25 Paar in Werkstatt-Verpackung	25 pair in workshop-packaging
-------------------------	---------------------------------	-------------------------------



361622 4,90 € / pair	V-BREMSSCHUHE ›BPR-VC-BASE-TWIN‹	V-BRAKE SHOES ›BPR-VC-BASE-TWIN‹
	<ul style="list-style-type: none"> • Länge: 70 mm • symmetrisch • 2 Paar auf M-Wave Eurolochkarte 	<ul style="list-style-type: none"> • length: 70 mm • symmetric • 2 pairs on M-Wave eurohole card



361022	V-BREMSSCHUHE ›BPR-VC-NT‹	V BRAKE SHOES ›BPR-VC-NT‹
	<ul style="list-style-type: none"> • Länge: 72 mm • für trockene und nasse Verhältnisse • für alle Stahl- und Aluminiumfelgen • Bolzen ohne Gewinde 	<ul style="list-style-type: none"> • length: 72 mm • for dry and wet conditions • for all steel- and aluminium rims • bolt without thread

Tested by the manufacturer based on ISO 4210

361022 paarweise auf M-Wave Eurolochkarte

1 pair on M-Wave eurohole card





361023 paarweise im Polybeutel
2,90 € / pair

1 pair in PE bag

361792 5,90 € / pair	BREMSSCHUHE FÜR HYDRAULISCHE FELGENBREMSEN ›BPR-HY‹	BRAKE SHOES FOR HYDRAULIC RIM BRAKES ›BPR-HY‹
	<ul style="list-style-type: none"> • für Aluminium- und Stahlfelgen • z. B. für Magura HS11, HS22, HS33R, HS33R Trial, HS33 R FIRMtech (kein original Magura Ersatzteil) • 50 mm • paarweise im Polybeutel 	<ul style="list-style-type: none"> • for aluminium and steel rims • e. g. Magura HS11, HS22, HS33R, HS33R Trial, HS33 R FIRMtech (no original Magura spare part) • 50 mm • 1 pair in PE bag

Tested by the manufacturer based on ISO 4210



ART.-NR. UVP	BESCHREIBUNG	DESCRIPTION	
361770 8,90 € / pair	CARTRIDGE RENNRAD-BREMSSCHUHE ›BPR-RR-BASE-ALU‹ <ul style="list-style-type: none"> • Aluminium-Bremsschuhe mit austauschbaren Bremsgummis • Länge: 55 mm • auch für Rennradbremsen von Shimano (Dura Ace, Ultegra, ...; kein original Shimano-Ersatzteil) • für trockene und nasse Verhältnisse • für alle Stahl- und Aluminiumfelgen • paarweise auf M-Wave Eurolochkarte 	CARTRIDGE ROAD RACING BRAKE SHOES ›BPR-RR-BASE-ALU‹ <ul style="list-style-type: none"> • aluminium brake shoes with replaceable brake rubbers • length: 55 mm • also for racing brakes of Shimano (Dura Ace, Ultegra, ...; no original Shimano spare part) • for dry and wet conditions • for all steel- and aluminium rims • 1 pair on M-Wave eurohole card 	<div data-bbox="1308 224 1497 264" style="border: 1px solid black; padding: 2px; font-size: 8px;">Tested by the manufacturer based on ISO 4210</div> 
361772 2,90 € / pair	BREMSSCHUH-ERSATZBELAG ›BPR-INSERT-RR‹ <ul style="list-style-type: none"> • passend für Art. 361770 und Shimano Bremsen (Dura Ace, Ultegra, ...; kein original Shimano Ersatzteil) • paarweise auf M-Wave Eurolochkarte 	BRAKE SHOE REPLACEMENT RUBBER ›BPR-INSERT-RR‹ <ul style="list-style-type: none"> • suitable for art. 361770 and Shimano brakes (Dura Ace, Ultegra, ...; no original Shimano spare part) • 1 pair on M-Wave eurohole card 	
	BREMSSCHUHE ›BPR-T‹ <ul style="list-style-type: none"> • Länge: 55 mm • für trockene und nasse Verhältnisse • für alle Stahl- und Aluminiumfelgen • Bolzen mit Gewinde und Befestigungsmaterial 	BRAKE SHOES ›BPR-T‹ <ul style="list-style-type: none"> • length: 55 mm • for dry and wet conditions • for all steel- and aluminium rims • bolt with thread and mounting material 	<div data-bbox="1308 936 1497 976" style="border: 1px solid black; padding: 2px; font-size: 8px;">Tested by the manufacturer based on ISO 4210</div> 
361030 2,90 € / pair	paarweise auf M-Wave Eurolochkarte	1 pair on M-Wave eurohole card	
361754 1,50 € / pair	100 St. im Polybeutel	100 pcs in PE bag	



M-WAVE

YOUR WORLD OF CYCLING

www.m-wave-bike.com

ART.-NR. UVP **BESCHREIBUNG**

DESCRIPTION

370295 KABELFÜHRUNG

6,90 € / set

- für 4-5 mm Außenhüllen
- kann **universell durch Kabelbinder** am Rahmen befestigt oder **aufgeklebt** werden
- 3 Stk. im Polybeutel mit M-Wave Eurolochheader

CABLE GUIDE

- for 4-5 mm outer housings
- can **universally** be mounted to frames **with cable ties** or **sticker**
- 3 pcs. in PE bag with M-Wave eurohole header



**3 BEFESTIGUNGSMÖGLICHKEITEN
3 ATTACHMENT POSSIBILITIES**

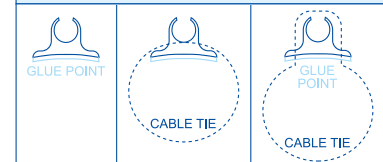

AUSSENHÜLLENENDHÜLSEN

- **CNC-gefräst**
- 12 mm lang
- 200 Stk. in M-Wave Dose

OUTER HOUSING END CAPS

- **CNC machined**
- length 12 mm
- 200 pcs. in M-Wave can

- Innen-Ø **4,1 mm**
- für Schalt-/(Brems-)zughüllen

- inner-Ø **4.1 mm**
- for derailleur/(brake) cable outer housings



370210 rot eloxiert

red anodised

370231 blau eloxiert

blue anodised

370232 grün eloxiert

green anodised



- Innen-Ø **5,1 mm**
- für Brems-/(Schalt-)zughüllen

- inner-Ø **5.1 mm**
- for brake/(derailleur) cable outer housings



370211 rot eloxiert

red anodised

370236 blau eloxiert

blue anodised

370237 grün eloxiert

green anodised



370238 gold-orange eloxiert

gold-orange anodised

249,00 € / 1.000

ENDHÜLSE FÜR INNENZÜGE

- **Aluminium**
- Innen-Ø ca. 1,7 x 10 mm Länge
- 500 Stk. in M-Wave Dose

END CAP FOR INNER CABLES

- **aluminium**
- inner-Ø approx. 1.7 mm x 10 mm length
- 500 pcs. in M-Wave can



370218 schwarz eloxiert

black anodised

99,90 € / 1.000

370217 rot eloxiert

red anodised

370226 blau eloxiert

blue anodised

370227 grün eloxiert



green anodised

370228 gold-orange eloxiert

gold-orange anodised

69,90 € / 1.000



ART.-NR. UVP	BESCHREIBUNG	DESCRIPTION	
	SCHUTZBLECH-SET <ul style="list-style-type: none"> für Vorder- und Hinterrad Kunststoff Länge werkzeuglos verstellbar Steckbefestigung auf M-Wave Eurolochkarte 	MUDGUARD SET <ul style="list-style-type: none"> front and rear plastic length adjustable without tools clip-on system on M-Wave eurohole card 	
385137 27,90 € / set	›MUD MAX F+R ADJ L‹ <ul style="list-style-type: none"> universell passend für 26" - 29" mit Sicherheitsstrebenbefestigung max. Reifenbreite: 62 mm 	›MUD MAX F+R ADJ L‹ <ul style="list-style-type: none"> universal type for 26" - 29" with safety stays max. tire width: 62 mm 	
385138 16,90 € / set	›MUD MAX F+R ADJ S‹ <ul style="list-style-type: none"> universell passend für 20" - 24" max. Reifenbreite: 55 mm 	›MUD MAX F+R ADJ S‹ <ul style="list-style-type: none"> universal type for 20" - 24" max. tire width: 55 mm 	
	SCHUTZBLECH-SET ›MUD MAX UNIVERSAL‹ 26" - 29" <ul style="list-style-type: none"> für Vorder- und Hinterrad universell passend für 26" - 29" Kunststoff seitliche Versteifungen variable Steckbefestigung passend für V- und Cantilever-Bremsen mit langem Spritzchutz 	MUDGUARD SET ›MUD MAX UNIVERSAL‹ 26" - 29" <ul style="list-style-type: none"> front and rear universal type for 26" - 29" plastic reinforced sides variable clip-on system for V- and cantilever brakes with long end 	
386080 386085 9,90 € / set	in M-Wave Verpackung Set im Polybeutel	in M-Wave packaging set in PE bag	
386086 8,90 € / set	wie Art. 386085, aber <ul style="list-style-type: none"> mit Klettband für zusätzliche Sicherheitsbefestigung am Sitzrohr Set auf M-Wave Eurolochkarte 	like art. 386085, but <ul style="list-style-type: none"> with hook and loop fastener for additional security fixing at the seat tube set on M-Wave eurohole card 	
	SCHUTZBLECH-SET 26" <ul style="list-style-type: none"> für Vorder- und Hinterrad 26", MTB Modell ›ECO‹ Kunststoff passend für V- und Cantilever-Bremsen Steckbefestigung 	MUDGUARD SET 26" <ul style="list-style-type: none"> front and rear 26", MTB modell ›ECO‹ plastic for V- and cantilever brakes clip-on system 	
386047 386048 6,90 € / set	in M-Wave Verpackung (Art. 084090) Set im Polybeutel	in M-Wave packaging (art. 084090) set in PE bag	

ART.-NR. UVP **BESCHREIBUNG**

DESCRIPTION

- 386031** **SCHUTZBLECH-SET 28"**
 ›MUD MAX II F+R‹
 25,90 € / set
- für Vorder- und Hinterrad
 - **28"**
 - Breite: 45 mm
 - aus **hochwertigem, flexiblem Kunststoff: ohne Beschädigung knick- und drehbar**
 - **Sicherheitsstrebenbefestigung aus Nirosta**
 - Befestigungsmaterialien aus **Nirosta**
 - langer **Spritzschutz aus Gummi hinten**
 - auf M-Wave Eurolochkarte

- MUDGUARD SET 28"**
 ›MUD MAX II F+R‹
- front and rear
 - **28"**
 - width: 45 mm
 - **high quality flexible plastic: turnable and bendable without damage**
 - **stainless steel safety stays**
 - mounting materials made of **stainless steel**
 - long **rubber end at the rear**
 - on M-Wave eurohole card



Ab einer Mindestmenge von 500 Paar sind diese Schutzbleche ohne Aufpreis auch in blau, rot, gelb, schwarz, grau oder weiß erhältlich!
 Spritzschutz in 12 verschiedenen Farben erhältlich.

From a minimum of 500 pairs, these mudguards are also available in blue, red, yellow, black, grey or white without upcharge!
 Rubber end available in 12 different colours.



- 386096** **SCHUTZBLECH-SET 26" - 29"**
 ›MUD MAX III‹
 11,90 € / set
- für Vorder- und Hinterrad
 - **universell** passend für **26" - 29"**
 - Kunststoff
 - Steckbefestigung und **Sicherheitsstrebenbefestigung**
 - mit **langem Spritzschutz**
 - Set im Polybeutel

- MUDGUARD SET 26" - 29"**
 ›MUD MAX III‹
- front and rear
 - **universal type for 26" - 29"**
 - plastic
 - clip-on system and **safety stays**
 - with **long end**
 - set in PE bag



- 385088** **STECK-SCHUTZBLECH**
 ›MUD MAX F III‹
 24,90 €
- für Vorderrad
 - universell passend für **26"-29"**
 - auch für **Federgabeln** geeignet
 - mit **Clip-on-Halter** und **Konusbefestigung** im Gabelschaft (mit Adaptern für Ø 18 - 36 mm)
 - auf M-Wave Eurolochkarte







- CLIP-ON MUDGUARD**
 ›MUD MAX F III‹
- front
 - universal type for **26"-29"**
 - to be used for **suspension forks** as well
 - with **clip-on bracket** and **coneclamp** in fork innertubes (with adapters for Ø 18 - 36 mm)
 - on M-Wave eurohole card



- 385089** **STECK-SCHUTZBLECH**
 ›MUD MAX R III‹
 24,90 €
- für Hinterrad
 - universell passend für **26"-29"**
 - mit universellem **Clip-on-Halter** passend für Sattelstützen
 - Winkel verstellbar
 - auf M-Wave Eurolochkarte

- CLIP-ON MUDGUARD**
 ›MUD MAX R III‹
- rear
 - universal type for **26"-29"**
 - with universal **clip-on bracket** for seat posts
 - angle adjustable
 - on M-Wave eurohole card



ART.-NR. UVP	BESCHREIBUNG	DESCRIPTION	
385070 19,90 €	STECKSCHUTZBLECH ›MUD MAX QR.F II‹ <ul style="list-style-type: none"> • für Vorderrad • universell passend für 26" - 29" • auch für Federgabeln geeignet • mit Konusbefestigung im Gabelschaft (mit Adapter für Ø 18,5 – 34,5 mm) • auf M-Wave Eurolochkarte 	CLIP ON MUDGUARD ›MUD MAX QR.F II‹ <ul style="list-style-type: none"> • front • universal type for 26" - 29" • to be used for suspension forks as well • with coneclamp in fork innertube (with adapter for Ø 18.5 – 34.5 mm) • on M-Wave eurohole card 	
385071 27,90 €	STECKSCHUTZBLECH ›MUD MAX QR.R II‹ <ul style="list-style-type: none"> • für Hinterrad • universell passend für 26" - 29" • mit universellem Clip-on-Halter passend für Sattelstütze und Rahmenrohr • stabile 3-Punkt Halterung reduziert Flattern • Winkel und Höhe verstellbar • auf M-Wave Eurolochkarte 	CLIP ON MUDGUARD ›MUD MAX QR.R II‹ <ul style="list-style-type: none"> • rear • universal type for 26" - 29" • with universal clip-on bracket for seat post and frame tube • stable 3 point fixation reduces fluttering • angle and height adjustable • on M-Wave eurohole card 	
385130 16,90 €	STECK-SCHUTZBLECH ›MUD MAX QR.F III‹ <ul style="list-style-type: none"> • für Vorderrad • universell passend für 26" - 29" • auch für Federgabeln geeignet • mit Konusbefestigung im Gabelschaft (Adapter für Ø 16 - 35 mm) • lässt sich in 2 Teilen von der Halterung abnehmen • max. Reifenbreite: 85 mm • auf M-Wave Eurolochkarte 	CLIP-ON MUDGUARD ›MUD MAX QR.F III‹ <ul style="list-style-type: none"> • front • universal type for 26" - 29" • to be used for suspension forks as well • with coneclamp in fork innertube (with adapter for Ø 16 - 35 mm) • can be removed from the bracket in 2 parts • max. tire width: 85 mm • on M-Wave eurohole card 	
	STECK-SCHUTZBLECH <ul style="list-style-type: none"> • für Hinterrad • mit universellem Halter passend für Sattelstützen mit Ø 24 - 36 mm • Winkel verstellbar • auf M-Wave Eurolochkarte 	CLIP-ON MUDGUARD <ul style="list-style-type: none"> • rear • with universal bracket for seat posts with Ø 24 - 36 mm • angle adjustable • on M-Wave eurohole card 	
385133 14,90 €	›MUD MAX QR.R III‹ <ul style="list-style-type: none"> • universell passend für 26" - 29" • max. Reifenbreite: 85 mm 	›MUD MAX QR.R III‹ <ul style="list-style-type: none"> • universal type for 26" - 29" • max. tire width: 85 mm 	
385135 12,90 €	›MUD MAX QR.R SLIM‹ <ul style="list-style-type: none"> • 28" • für Rennrad-, Gravel-, und Trekkingräder • max. Reifenbreite: 42 mm 	›MUD MAX QR.R SLIM‹ <ul style="list-style-type: none"> • 28" • for road, gravel and trekking bikes • max. tire width: 42 mm 	

ART.-NR. UVP **BESCHREIBUNG**

DESCRIPTION

385054 **SCHUTZBLECH**
›MUD MAX QR.F‹
14,90 €

- für Vorderrad
- universell passend für **26" - 29"**
- auch für **Federgabeln** geeignet
- mit **Clip-on-Halter** und **Konusbefestigung** im Gabelschaft (mit Adaptern für Ø 18,5 - 34,5 mm)
- auf M-Wave Eurolochkarte

MUDGUARD
›MUD MAX QR.F‹

- front
- universal type for **26" - 29"**
- to be used for **suspension forks** as well
- with **clip-on bracket** and **coneclamp** in fork innertube (with adapters for Ø 18.5 - 34.5 mm)
- on M-Wave eurohole card

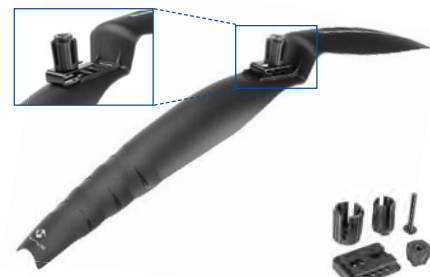

385055 **SCHUTZBLECH**
›MUD MAX QR.R‹
15,90 €

- für Hinterrad
- universell passend für **26" - 29"**
- Kunststoff
- mit universellem **Clip-on-Halter** passend für Sattelstütze und Rahmenrohr
- **Winkel** und **Höhe verstellbar**
- auf M-Wave Eurolochkarte

MUDGUARD
›MUD MAX QR.R‹

- rear
- universal type for **26" - 29"**
- plastic
- with universal **clip-on bracket** for seat post and frame tube
- **angle** and **height adjustable**
- on M-Wave eurohole card



386205 **SCHUTZBLECH**
›MUD MAX FAT F‹
19,90 €

**PLUS/
FAT**

- für Vorderrad
- universell passend für **24" - 29"**
- Breite **115 mm**
- Kunststoff
- mit **Konusbefestigung** im Gabelschaft **1" - 1 1/8"**
- **Winkel verstellbar**
- auf M-Wave Eurolochkarte

MUDGUARD
›MUD MAX FAT F‹

- front
- universal type for **24" - 29"**
- width **115 mm**
- plastic
- with **coneclamp** in fork innertube **1" - 1 1/8"**
- **angle adjustable**
- on M-Wave eurohole card



386206 **SCHUTZBLECH**
›MUD MAX FAT R‹
24,90 €



- für Hinterrad
- universell passend für **24" - 29"**
- Breite **115 mm**
- Kunststoff
- **werkzeuglose** Montage
- mit universellem Halter passend für Sattelstütze und Sattelrohr, für Ø 27,2 - 33,5 mm
- **Winkel** und **Höhe verstellbar**
- auf M-Wave Eurolochkarte

MUDGUARD
›MUD MAX FAT R‹

- rear
- universal type for **24" - 29"**
- width **115 mm**
- plastic
- **toolless** mounting
- with universal bracket suitable for seat post and frame tube, for Ø 27.2 - 33.5 mm
- **angle** and **height adjustable**
- on M-Wave eurohole card



386030 **SCHUTZBLECH** ›MUD MAX II R‹
7,90 €

- für Hinterrad
- universell passend für **20" - 29"**
- aus **hochwertigem, flexiblem Kunststoff: ohne Beschädigung knick- und drehbar**
- inkl. Halter für Sattelstütze, passend für Ø 25,0 - 31,8 mm
- **Winkel** und **Höhe** durch 2 Gelenke **zweifach verstellbar**
- auf M-Wave Eurolochkarte

MUDGUARD ›MUD MAX II R‹

- for rear
- universal type for **20" - 29"**
- **high quality flexible plastic: turnable and bendable without damage**
- incl. bracket for seat post, suitable for Ø 25.0 - 31.8 mm
- **angle** and **height doubly adjustable** by two hinges
- on M-Wave eurohole card



ART.-NR. UVP
BESCHREIBUNG

DESCRIPTION

**SCHUTZBLECH-SET
›MUD MAX KIDS F+R‹**

- für Vorder- und Hinterrad
- aus **hochwertigem, flexiblem Kunststoff: ohne Beschädigung knick- und drehbar**
- **seitliche Versteifungen**
- passend für V- und Cantilever-Bremsen
- variable **Steckbefestigung**
- langer **Spritzschutz aus Gummi hinten**
- auf M-Wave Eurolochkarte

**MUDGUARD SET
›MUD MAX KIDS F+R‹**

- for front and rear
- **high quality flexible plastic: turnable and bendable without damage**
- **reinforced sides**
- suitable for V- and cantilever brakes
- variable **clip-on-system**
- long **rubber end at the rear**
- on M-Wave eurohole card



386033 für 16" - 20" Kinderräder

for 16" - 20" children bikes

386032 für 12" - 18" Kinderräder
13,90 €

for 12" - 18" children bikes

Ab einer Mindestmenge von 500 Paar sind diese Schutzbleche ohne Aufpreis auch in blau, rot, gelb, schwarz, grau oder weiß erhältlich! Spritzschutz in 12 verschiedenen Farben erhältlich.

From a minimum of 500 pairs, these mudguards are also available in blue, red, yellow, black, grey or white without upcharge! Rubber end available in 12 different colours.



386011 DIRT BOARD ›MUD MAX DT‹

5,90 €



- universelle Befestigung am Unterrohr
- asymmetrisches Design für **optimalen Schutz bei unterschiedlichen Fahrpositionen** (180° drehbar)
- **werkzeuglose Montage** mit 2 Gummibändern
- aus schlagfestem Kunststoff
- mit Non-Slip-Einlagen
- ca. 32 x 9/13 cm
- auf M-Wave Eurolochkarte

DIRT BOARD ›MUD MAX DT‹

- universal mounting on the down tube
- asymmetric design **to protect optimally in various drive positions** (180° turnable)
- **toolless** mounting by two rubber strips
- impact resistant plastic
- with non-slip inlays
- approx. 32 x 9/13 cm
- on M-Wave eurohole card



385136 DIRT BOARD ›MUD MAX DT.S‹

7,90 €



- schmale Ausführung für **Renntagel- und Trekkingräder**
- universelle Befestigung am Unterrohr
- **werkzeuglose Montage** mit 2 Gummibändern
- max. Reifenbreite: 60 mm
- auf M-Wave Eurolochkarte

DIRT BOARD ›MUD MAX DT.S‹

- narrow version **for road, gravel and trekking bikes**
- universal mounting on the down tube
- **toolless mounting** by 2 rubber strips
- max. tire width: 60 mm
- on M-Wave eurohole card



**385131 UNIVERSAL SCHUTZBLECH
›MUD MAX FLEX F‹**

9,90 €



- für Vorderrad
- universell passend für **26" - 29"**
- **strapazierfähiger Kunststoff**
- **werkzeuglose Befestigung an der Gabel**
- max. Reifenbreite: 82 mm
- inkl. 6 Kabelbinder
- auf M-Wave Eurolochkarte

**UNIVERSAL MUDGUARD
›MUD MAX FLEX F‹**

- front
- universal type for **26" - 29"**
- **hard-wearing plastic**
- **toolless attachment to the fork**
- max. tire width: 82 mm
- incl. 6 cable ties
- on M-Wave eurohole card



ART.-NR. BESCHREIBUNG
UVP

DESCRIPTION

385132 UNIVERSAL SCHUTZBLECH

›MUD MAX FLEX F/R ‹

7,90 €



- für **Vorder-** oder **Hinterrad**
- universell passend für **26" - 29"**
- **strapazierfähiger** und **flexibler Kunststoff**
- **werkzeuglose Befestigung** an der **Gabel** oder durch Zuschneiden einfache Anbringung am **Sattelgestell**
- Länge: 325 mm
- inkl. 4 Kabelbinder
- auf M-Wave Eurolochkarte

UNIVERSAL MUDGUARD

›MUD MAX FLEX F/R ‹

- **front** or **rear**
- universal type for **26" - 29"**
- **hard-wearing** and **flexible plastic**
- **toolless attachment** to the **fork** or easy attachment to the **saddle rails** by cutting to size
- length: 325 mm
- incl. 4 cable ties
- on M-Wave eurohole card



385052 UNIVERSAL SCHUTZBLECH

›MUD MAX FLEX F/R ‹

5,90 €



- für **Vorder-** oder **Hinterrad**
- **strapazierfähiger** und **flexibler Kunststoff**
- zur Befestigung an **Gabel** und **Sitzrohrstreben**
- **werkzeuglose** Montage
- universell passend für fast alle Fahrräder
- inkl. 4 Kabelbinder
- auf M-Wave Eurolochkarte

UNIVERSAL MUDGUARD

›MUD MAX FLEX F/R ‹

- for **front** or **rear**
- **hard-wearing** and **flexible plastic**
- for attachment to **fork** and **seat stays**
- **toolless** mounting
- universally suitable for almost all bikes
- incl. 4 cable ties
- on M-Wave eurohole card



385051 UNIVERSAL SCHUTZBLECH

›MUD MAX FLEX R ‹

5,90 €



- für **Hinterrad**
- **strapazierfähiger** und **flexibler Kunststoff**
- besserer Schutz durch **Verlängerung**
- zur Schnellbefestigung am Sattelgestell
- **werkzeuglose** Montage
- universell passend für fast alle Fahrräder
- nur **18 g**
- auf M-Wave Eurolochkarte

UNIVERSAL MUDGUARD

›MUD MAX FLEX R ‹

- for **rear**
- **hard-wearing** and **flexible plastic**
- better protection through **extension**
- for fast attachment to saddle rails
- **toolless** mounting
- universally suitable for almost all bikes
- only **18 g**
- on M-Wave eurohole card



SCHUTZBLECH FÜR SATTEL- GESTELL

- zur **werkzeuglosen** Schnellbefestigung am Sattelgestell
- universell passend für **26" - 29"**
- **Winkel verstellbar**
- auf M-Wave Eurolochkarte

MUDGUARD FOR SADDLE RAILS

- for fast **toolless** attachment to saddle rails
- universal type for **26" - 29"**
- **angle adjustable**
- on M-Wave eurohole card



385134 ›MUD MAX SEAT LONG ‹

12,90 €

- nur 74 g
- max. Reifenbreite: 75 mm

›MUD MAX SEAT LONG ‹

- only 74 g
- max. tire width: 75 mm

385139 ›MUD MAX SEAT SHORT ‹

13,90 €

- nur 105 g
- max. Reifenbreite: 125 mm

›MUD MAX SEAT SHORT ‹

- only 105 g
- max. tire width: 125 mm



ART.-NR. UVP **BESCHREIBUNG**

DESCRIPTION



SCHUTZBLECH-SET ›MUD MAX RACE QR‹ 28"

- für Vorder- und Hinterrad
- **flexibles** Kunststoffschutzblech
- mit **Schnellverschlüssen** (Art. 385098) zur **werkzeuglosen** Montage an den Sitzrohrstreben/Gabelscheidern
- mit **längenverstellbarer** Strebenbefestigung aus **Nirosta**
- auf M-Wave Eurolochkarte

MUDGUARD SET ›MUD MAX RACE QR‹ 28"

- front and rear
- **flexible** plastic mudguard
- with **quick releases** (art. 385098) for **toolless** mounting at the seat stays/fork legs
- with **length adjustable stainless steel** safety stays
- on M-Wave eurohole card



385061 Breite **33 mm**
mit **abnehmbarem Verlängerungsstück**

width **33 mm**
with **removable extension piece**

385081 Breite **42 mm**
49,90 €

width **42 mm**





SCHUTZBLECH-SET

- für Vorder- und Hinterrad
- **flexibles** Kunststoffschutzblech
- integrierter, **2-facher**, elektrischer **Kontaktstreifen**
- **längenverstellbare Sicherheits-** Strebenbefestigung aus **Nirosta** mit **2 cm Verstellbereich**
- **Sicherheitsenden**
- inklusive 2 Anschlusslichtkabeln

MUDGUARD SET

- front and rear
- **flexible** plastic mudguard
- integrated, **double**, electrical **contact**
- **length adjustable stainless steel** safety stays with **2 cm variability**
- **safety ends**
- incl. 2 dynamo cables

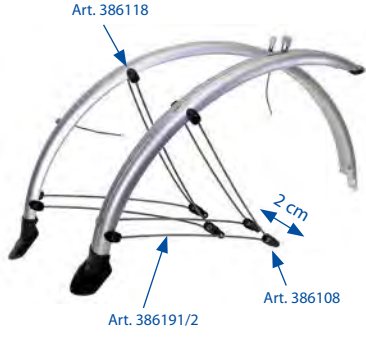

 M-Wave Verpackung / M-Wave packaging	 schwarz / black		 silber / silver	
	in M-Wave Verpackung in M-Wave packaging	Set im Polybeutel set in PE bag	in M-Wave Verpackung in M-Wave packaging	Set im Polybeutel set in PE bag
20" Breite/width 56 mm	386170	386110		
24" Breite/width 56 mm	386171	386117		
26" Breite/width 60 mm	386172	386104	386173	386107
27,5" Breite/width 60 mm	386178	386180		
28" Breite/width 45 mm	386174	386105	386175	386106
28"/29" Breite/width 56 mm	386176	386115	386177	386116
29" Breite/width 60 mm	386179	386181		
UVP	27,90 € / Set	27,90 € / Set	27,90 € / Set	27,90 € / Set

389992 AUFPREIS SCHUTZBLECHE

- für farbigen Mittelstreifen
- erhältlich für Art. 386104-7, 386110, 386115-7, ...

UPCHARGE MUDGUARDS

- for coloured middle strip
- available for art. 386104-7, 386110, 386115-7, ...



ART.-NR. UVP	BESCHREIBUNG	DESCRIPTION
-----------------	--------------	-------------

FELGE ›R4022‹

- Aluminium Hohlkammerfelge
- **28" / 622 mm**
- Felgenhöhe 40 mm
- 32 Loch
- mit Verschleißanzeige
- **CNC aufgeraute Bremsflanken (GBS)**
- AV/DV/FV
- ERD: 559 mm

RIM ›R4022‹

- aluminium hollow section rim
- **28" / 622 mm**
- rim height 40 mm
- 32 hole
- with wearout indicator
- **CNC grooved braking sides (GBS)**
- AV/DV/FV
- ERD: 559 mm

Tested by the manufacturer based on ISO 4210

381040 schwarz

black

381041 silber

silver

381042 weiß

white

28,90 €

381048 pink

pink

24,90 €



380467 ENDURO DISC FELGE ›4.30‹

51,90 €

PLUS

560 g

- **622 x 30**
- aus extrem steifem **6005 Aluminium**
- **Nirosta-Ösen**
- **30 mm** Innenbreite
- **tubeless** ready
- **Inner-Hump-Technologie: speziell konstruiertes Felgenprofil** hält den Reifen auch bei Druckverlust länger auf der Felge
- nur 560 g
- 32 Loch
- ERD: 598 mm
- schwarz eloxiert
- für FV
- max. Belastbarkeit **140 kg**

ENDURO DISC RIM ›4.30‹

- **622 x 30**
- made of extremely stiff **6005 aluminium**
- **stainless steel eyelets**
- **30 mm** inner width
- **tubeless** ready
- **Inner-Hump-Technology: a specially constructed rim profile** keeps the tire longer on the rim also in case of pressure loss
- only 560 g
- 32 hole
- ERD: 598 mm
- black anodised
- for FV
- max. load capacity **140 kg**

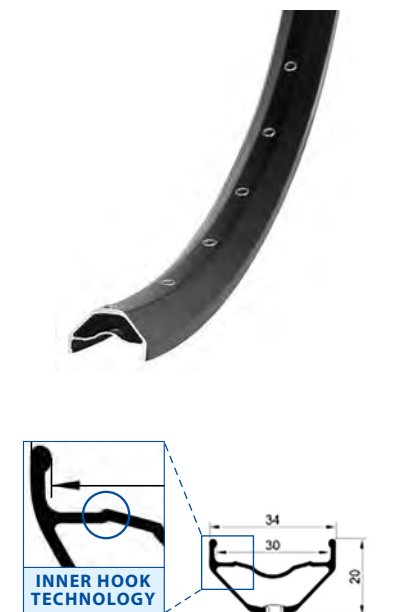

380466 DISC FELGE ›2.19‹

27,90 €

- **622 x 19**
- aus extrem steifem **6005 Aluminium**
- **Nirosta-Ösen**
- 32 Loch
- für AV
- schwarz eloxiert
- ERD: 598 mm

DISC RIM ›2.19‹

- **622 x 19**
- made of extremely stiff **6005 aluminium**
- **stainless steel eyelets**
- 32 hole
- for AV
- black anodised
- ERD: 598 mm



ART.-NR. BESCHREIBUNG
UVP

DESCRIPTION

AHEAD INTEGRIERT

AHEAD INTEGRATED

**390801 INTEGRIERTER CARTRIDGE-
STEUERSATZ, 1 1/8" → 1,5"**
›IS42/52 C‹

19,90 € / set



- **Aluminium**
- 45° x 45°
- mit **Industriekugellager**
- inkl. Krallen
- schwarz
- **nur 80 g** (ohne Krallen)
- SHIS: IS42/28,6 | IS52/40
- im M-Wave Einzelkarton

- A** = 28,5 mm
= Innen-Ø des oberen Abschlussrings
- B1** = 41,8 mm
= Außen-Ø des oberen Kugellagers
- B2** = 52,0 mm
= Außen-Ø des unteren Kugellagers
- C** = 39,8 mm
= Konussitz auf Gabel

**INTEGRATED CARTRIDGE
HEAD SET, 1 1/8" → 1.5"**
›IS42/52 C‹

- **aluminium**
- 45° x 45°
- with **sealed bearing**
- incl. star nut
- black
- **only 80 g** (w/o star nut)
- SHIS: IS42/28.6 | IS52/40
- in M-Wave box

- A** = 28.5 mm
= inner-Ø of the upper cap ring
- B1** = 41.8 mm
= outer-Ø of the upper bearing
- B2** = 52.0 mm
= outer-Ø of the lower bearing
- C** = 39.8 mm
= cone seat on the fork



**390800 INTEGRIERTER CARTRIDGE
STEUERSATZ 1 1/8"**
›IS42/42 C‹

14,90 € / set

- **Aluminium**
- schwarz
- Campa Standard = 41,8 mm x 45° x 45°
- 2 x 0,28 mm Ausgleichsscheiben
- nur 89 g (ohne Klemme)
- SHIS: IS42/28,6 | IS42/30
- im M-Wave Einzelkarton

- A** = 28,5 mm
- B1=B2** = 41,8 mm
- C** = 30,0 mm

**INTEGRATED CARTRIDGE
HEAD SET 1 1/8"**
›IS42/42 C‹

- **aluminium**
- black
- Campa standard = 41.8 mm x 45° x 45°
- 2 x 0.28 mm shims
- only 89 g (w/o clamp)
- SHIS: IS42/28.6 | IS42/30
- in M-Wave box

- A** = 28.5 mm
- B1=B2** = 41.8 mm
- C** = 30.0 mm



AHEAD SEMI-INTEGRIERT

AHEAD SEMI INTEGRATED

**390809 SEMI-INTEGRIERTER CARTRIDGE
STEUERSATZ 1 1/8" → 1,5"**
›ZS44/56 C‹

19,90 € / set

- **1 1/8"** oben / **1,5"** unten
- schwarz
- **Aluminium**
- SHIS: ZS44/28,6 | ZS56/40
- im M-Wave Einzelkarton

- A** = 28,6 mm
= Innen-Ø des oberen Abschlussrings
- B1** = 44 mm
= Außen-Ø der oberen Lagerschale
- B2** = **56,0 mm**
= Außen-Ø der unteren Lagerschale
- C** = 39,8 mm
= Konussitz auf Gabel

**SEMI INTEGRATED CARTRIDGE
HEAD SET 1 1/8" → 1.5"**
›ZS44/56 C‹

- **1 1/8"** top / **1.5"** bottom
- black
- **aluminium**
- SHIS: ZS44/28.6 | ZS56/40
- in M-Wave box

- A** = 28.6 mm
= inner-Ø of the upper cap ring
- B1** = 44 mm
= outer-Ø of the upper bearing shell
- B2** = **56.0 mm**
= outer-Ø of the lower bearing shell
- C** = 39.8 mm
= cone seat on the fork



Head sets & Accessories

ART.-NR. UVP	BESCHREIBUNG	DESCRIPTION	
390810 9,90 € / set	SEMI-INTEGRIERTER TAPERED STEUERSATZ 1 1/8" → 1,5" ›ZS44/56 LB‹ <ul style="list-style-type: none"> • 1 1/8" oben / 1,5" unten • schwarz • Aluminium/Stahl • SHIS: ZS44/28,6 ZS56/40 • im M-Wave Einzelkarton <p>A = 28,6 mm = Innen-Ø des oberen Abschlussrings B1 = 44 mm = Außen-Ø der oberen Kugellagerschale B2 = 56,0 mm = Außen-Ø der unteren Kugellagerschale C = 39,8 mm = Konussitz auf Gabel</p>	SEMI INTEGRATED TAPERED HEAD SET 1 1/8" → 1.5" ›ZS44/56 LB‹ <ul style="list-style-type: none"> • 1 1/8" top / 1.5" bottom • black • aluminium/steel • SHIS: ZS44/28.6 ZS56/40 • in M-Wave box <p>A = 28.6 mm = inner-Ø of the upper cap ring B1 = 44 mm = outer-Ø of the upper bearing shell B2 = 56.0 mm = outer-Ø of the lower bearing shell C = 39.8 mm = cone seat on the fork</p>	

390580 19,90 €	SEMI-INTEGRIERTER CARTRIDGE STEUERSATZ 1 1/8" ›ZS44/44 C‹ <ul style="list-style-type: none"> • Aluminium • schwarz • 1 1/8" • SHIS: ZS44/28,6 ZS44/30 • im M-Wave Einzelkarton <p>A = 28,6 mm B = 44,0 mm C = 30,0 mm</p>	SEMI INTEGRATED CARTRIDGE HEAD SET 1 1/8" ›ZS44/44 C‹ <ul style="list-style-type: none"> • aluminium • black • 1 1/8" • SHIS: ZS44/28.6 ZS44/30 • in M-Wave box <p>A = 28.6 mm B = 44.0 mm C = 30.0 mm</p>	
--------------------------	---	--	--

390890 6,90 €	KLEMME FÜR AHEAD STEUERSATZ ›FORK FIX C‹ <ul style="list-style-type: none"> • wiederverwendbare Ahead-Klemme • für Carbon-Gabelschaft • 1 1/8" • auf M-Wave Eurolochkarte 	COMPRESSOR PLUG FOR AHEAD HEAD SET ›FORK FIX C‹ <ul style="list-style-type: none"> • reusable ahead clamp • for carbon steerer • 1 1/8" • on M-Wave eurohole card 	
-------------------------	---	---	---

390570 390571	KRALLE + ALUMINIUMKAPPE + SCHRAUBE FÜR AHEAD STEUERSATZ ›FORK FIX‹ <ul style="list-style-type: none"> • Krallen, Alukappe und Schraube in einem • für 1 1/8" <p>auf M-Wave Eurolochkarte</p>	STAR NUT + ALUMINIUM CAP + SCREW FOR AHEAD HEAD SET ›FORK FIX‹ <ul style="list-style-type: none"> • star nut, aluminium cap and screw • for 1 1/8" <p>on M-Wave eurohole card</p>	
390561 390461 390555	schwarz eloxiert silber eloxiert Montageverpackung schwarz eloxiert silber eloxiert rot eloxiert	black anodised silver anodised OEM black anodised silver anodised red anodised	
4,90 € / set			

ART.-NR. UVP	BESCHREIBUNG	DESCRIPTION
390517 9,90 €	STEUERSATZKAPPE ›CHEERS‹ Kronkorken <ul style="list-style-type: none"> mit magnetischer Halterung für 1½" Ahead Steuersätze Aluminium inkl. Befestigungsschraube auf M-Wave Eurolochkarte 	HEAD SET CAP ›CHEERS‹ <ul style="list-style-type: none"> with magnetic holder for bottle caps for 1½" ahead head sets aluminium incl. mounting screw on M-Wave eurohole card



Head sets & Accessories

	DISTANZRINGE ›RIO SPACER‹	SPACERS ›RIO SPACER‹
	<ul style="list-style-type: none"> Aluminium für 1½" 	<ul style="list-style-type: none"> aluminium for 1½"
	5 mm, 6 Stück auf M-Wave Eurolochkarte	5 mm, 6 pcs on M-Wave eurohole card
390640	schwarz eloxiert	black anodised
390641	silber eloxiert	silver anodised
5,90 € / set		
	5 mm, Montageverpackung	5 mm, OEM
390602	schwarz eloxiert	black anodised
390601	silber eloxiert	silver anodised
0,90 €		



SEMI-INTEGRIERT **SEMI INTEGRATED**

390806 14,90 € / set	SEMI-INTEGRIERTER CARTRIDGE STEUERSATZ 1½" ›ZS44/44 TC‹ <ul style="list-style-type: none"> 1½" schwarz Aluminium nur 94 g mit Industriekugellager SHIS: ZS44/28.6-26T ZS44/30 im M-Wave Einzelkarton <p>A = 28,6 mm = Innen-Ø des oberen Abschlussrings</p> <p>B = 44 mm = Außen-Ø der Kugellagerschalen</p> <p>C = 30,0 mm = Konussitz auf Gabel</p>	SEMI INTEGRATED CARTRIDGE HEAD SET 1½" ›ZS 44/44 TC‹ <ul style="list-style-type: none"> 1½" black aluminium only 94 g with sealed bearing SHIS: ZS44/28.6-26T ZS44/30 in M-Wave box <p>A = 28.6 mm = inner-Ø of the upper cap ring</p> <p>B = 44 mm = outer-Ø of the bearing shells</p> <p>C = 30.0 mm = cone seat on the fork</p>
-------------------------	--	---



ART.-NR. UVP **BESCHREIBUNG** **DESCRIPTION**

MTB LENKER
›HB-M3.1‹

- Aluminium
- konifiziert
- 780 mm
- mattschwarz
- für Klemmung Ø 31,8 mm
- 9° nach hinten gebogen
- 0° nach oben gebogen
- Höhe 5 mm
- mit Skala in der Mitte und an den Seiten

401516 auf M-Wave Eurolochkarte

401517 Montageverpackung

18,90 €

MTB HANDLEBAR
›HB-M3.1‹

- aluminium
- butted
- 780 mm
- matt black
- bar center Ø 31.8 mm
- 9° backsweep
- 0° upsweep
- rise 5 mm
- with scale in the middle and at the sides

on M-Wave eurohole card

OEM

Tested by the manufacturer based on ISO 4210

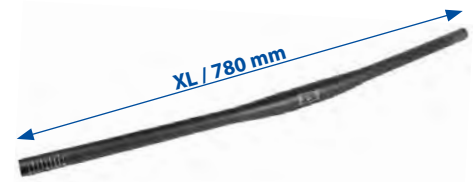

Handlebars & Accessories

403207 **MTB LENKER**

AD 8,90 €
mAD 12,90 €

- Aluminium
- konifiziert
- 680 mm
- mattschwarz
- für Klemmung Ø 31,8 mm
- 6° nach hinten gebogen
- 0° nach oben gebogen
- nur 240 g
- mit Skala in der Mitte und an den Seiten
- Montageverpackung

MTB HANDLEBAR

- aluminium
- butted
- 680 mm
- matt black
- bar center Ø 31.8 mm
- 6° backsweep
- 0° upsweep
- only 240 g
- with scale in the middle and at the sides
- OEM



MTB LENKER

- Aluminium
- 620 mm breit
- für Klemmung Ø 25,4 mm
- Montageverpackung

403684 schwarz

403685 silber

7,90 €
mAD 11,90 €

MTB HANDLEBAR

- aluminium
- width 620 mm
- bar center Ø 25.4 mm
- OEM

black

silver



MTB RISE LENKER
›HB-M4.1‹

- Aluminium
- doppelt konifiziert
- 780 mm
- mattschwarz
- für Klemmung Ø 31,8 mm
- 7° nach hinten gebogen
- mit Skala in der Mitte und an den Seiten

Höhe 10 mm, 4° nach oben gebogen

403225 auf M-Wave Eurolochkarte

403227 Montageverpackung

Höhe 20 mm, 3° nach oben gebogen

403226 auf M-Wave Eurolochkarte

403228 Montageverpackung

49,90 €

MTB RISE HANDLEBAR
›HB-M4.1‹

- aluminium
- double butted
- 780 mm
- matt black
- bar center Ø 31.8 mm
- 7° backsweep
- with scale in the middle and at the sides

rise 10 mm, 4° upsweep

on M-Wave eurohole card

OEM

rise 20 mm, 3° upsweep

on M-Wave eurohole card

OEM

Tested by the manufacturer based on ISO 4210



ART.-NR. UVP **BESCHREIBUNG**

DESCRIPTION

403630 **MTB RISE LENKER**
›A-RISE 780 OVERSIZE‹
 21,90 €
 mAD 31,90 €

- **Aluminium**
- **780 mm**
- für Klemmung **Ø 35 mm**
- 9° nach hinten gebogen
- 3° nach oben gebogen
- **Höhe 20 mm**
- mit Skala in der Mitte und an den Seiten
- schwarz
- auf M-Wave Eurolochkarte

MTB RISE HANDLEBAR
›A-RISE 780 OVERSIZE‹

- **aluminium**
- **780 mm**
- bar center **Ø 35 mm**
- 9° backsweep
- 3° upsweep
- **rise 20 mm**
- with scale in the middle and at the sides
- black
- on M-Wave eurohole card

Tested by the manufacturer based on ISO 4210



MTB RISE LENKER
›HB-M3.2‹

- **Aluminium**
- **doppelt konifiziert**
- mattschwarz
- für Klemmung **Ø 31,8 mm**
- 9° nach hinten gebogen
- 3° nach oben gebogen
- **Höhe 20 mm**
- mit Skala in der Mitte und an den Seiten

MTB RISE HANDLEBAR
›HB-M3.2‹

- **aluminium**
- **double butted**
- matt black
- bar center **Ø 31.8 mm**
- 9° backsweep
- 3° upsweep
- **rise 20 mm**
- with scale in the middle and at the sides

Tested by the manufacturer based on ISO 4210

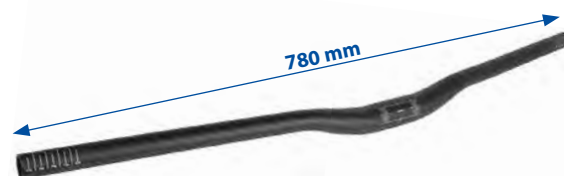

Handlebars & Accessories

780 mm
401518 auf M-Wave Eurolochkarte

780 mm
 on M-Wave eurohole card

401519 Montageverpackung

OEM

680 mm
401529 auf M-Wave Eurolochkarte

680 mm
 on M-Wave eurohole card

401524 Montageverpackung
 18,90 €

OEM

MTB RISE LENKER
›A-RISE 700C‹

- **Aluminium**
- **konifiziert**
- **700 mm**
- Klemmung **Ø 31,8 mm**
- 10° nach hinten gebogen
- 16° nach oben gebogen
- Höhe 30 mm
- nur 297 g
- mit **Skala** in der Mitte und an den Seiten

MTB RISE HANDLEBAR
›A-RISE 700C‹

- **aluminium**
- **butted**
- **700 mm**
- bar center **Ø 31.8 mm**
- 10° backsweep
- 16° upsweep
- rise 30 mm
- only 297 g
- with **scale** in the middle and at the sides

Tested by the manufacturer based on ISO 4210

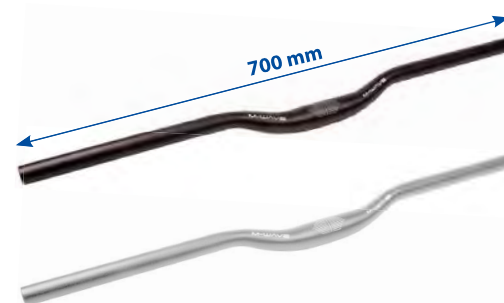

auf M-Wave Eurolochkarte

on M-Wave eurohole card

403500 mattschwarz eloxiert

matt black anodised

403501 silber eloxiert

silver anodised

19,90 €

Montageverpackung

OEM

403664 mattschwarz eloxiert

matt black anodised

403502 silber eloxiert

silver anodised



19,90 €
 mAD 28,90 €

ART.-NR. UVP **BESCHREIBUNG**

DESCRIPTION

TREKKING RISE LENKER
›HB-C2.1‹

- Aluminium
- mattschwarz
- Klemmung Ø 31,8 mm
- 640 mm
- 38° nach hinten gebogen
- 36° nach oben gebogen

Höhe 38 mm

403971 Montageverpackung

403974 auf M-Wave Eurolochkarte

Höhe 21 mm

403973 Montageverpackung

403976 auf M-Wave Eurolochkarte
19,90 €

TREKKING RISE HANDLEBAR
›HB-C2.1‹

- aluminium
- matt black
- bar center Ø 31.8 mm
- 640 mm
- 38° backsweep
- 36° upsweep

rise 38 mm

OEM

on M-Wave eurohole card

rise 21 mm

OEM

on M-Wave eurohole card

SIDE VIEW

Tested by the manufacturer based on ISO 4210



FRONT VIEW



- 660 mm
- 18° nach hinten gebogen
- 12° nach oben gebogen
- Höhe 25 mm

403972 Montageverpackung

19,90 €
mAD 28,90 €

403975 auf M-Wave Eurolochkarte
19,90 €

- 660 mm
- 18° backsweep
- 12° upsweep
- rise 25 mm

OEM

on M-Wave eurohole card



TOURING / TREKKING RISE LENKER

- Aluminium
- 600 mm
- Klemmung Ø 25,4 mm
- 15° nach hinten gebogen
- 30° nach oben gebogen
- Höhe 30 mm
- Montageverpackung

401206 schwarz

401207 silber

9,90 €
mAD 14,90 €

TOURING / TREKKING RISE HANDLEBAR

- aluminium
- 600 mm
- bar center Ø 25.4 mm
- 15° backsweep
- 30° upsweep
- rise 30 mm
- OEM

black

silver

Tested by the manufacturer based on ISO 4210



401282 TREKKING LENKER

44,90 €



- Aluminium
- **zusätzlicher Lenkerbogen** (Ø 22,2 mm) bietet **Platz** für Taschen, Lampen, Computer, Handys, innen montierte Lenkerzusatzgriffe, ...
- Breite 660 mm
- Klemmung Ø 31,8 mm
- 45° nach hinten gebogen
- Höhe 13 mm
- Montageverpackung

TREKKING HANDLEBAR

- aluminium
- **additional handlebar bow** (Ø 22.2 mm) offers **space** for bags, lamps, computers, mobile phones, inner bar ends, ...
- width 660 mm
- bar center Ø 31.8 mm
- 45° backsweep
- rise 13 mm
- OEM

Tested by the manufacturer based on ISO 4210





ART.-NR. UVP	BESCHREIBUNG	DESCRIPTION	
	TRIATHLON-AUFSATZ <ul style="list-style-type: none"> • Aluminium • schwarz • für Lenker Ø 31,8 mm (mit Adapter für Ø 25,4 mm) • Breite und Winkel der Armauflage verstellbar • Polster austauschbar • Ausleger mit Skala • nur 448 g • auf M-Wave Eurolochkarte 	TRI BAR <ul style="list-style-type: none"> • aluminium • black • for handlebar Ø 31.8 mm (with adapter for Ø 25.4 mm) • adjustable arm rest width and angle • pads replaceable • extension with scale • only 448 g • on M-Wave eurohole card 	
403750	›AERO F‹	›AERO F‹	
403742	›AERO H‹ 35,90 €	›AERO H‹	
	VERSTELLBARER LENKERVORBAU ›ST-C2.2‹ <ul style="list-style-type: none"> • Aluminium • schwarz • verstellbar von 0°- 90° • für 1 1/8" (25,4 mm) • Lenkerklemmung Ø 31,8 mm • Schaftlänge 180 mm <p>Länge 90 mm</p> <p>404014 auf M-Wave Karte</p> <p>404016 Montageverpackung</p> <p>Länge 110 mm</p> <p>404015 auf M-Wave Karte</p> <p>404017 Montageverpackung 22,90 €</p>	ADJUSTABLE HANDLE STEM ›ST-C2.2‹ <ul style="list-style-type: none"> • aluminium • black • adjustable from 0°- 90° • for 1 1/8" (25.4 mm) • clamp Ø 31.8 mm • shaft length 180 mm <p>length 90 mm</p> <p>on M-Wave tag</p> <p>OEM</p> <p>length 110 mm</p> <p>on M-Wave tag</p> <p>OEM</p>	<p>Tested by the manufacturer based on ISO 4210</p> 

Handlebars & Accessories

400446	HÖHENADAPTER ›CP LIFT‹ 19,90 € <ul style="list-style-type: none"> • Aluminium • für 1 1/8" • Höhe verstellbar durch 1 x 5 mm und 3 x 10 mm Distanzringe • inkl. Aheadkappe und Schraube • in M-Wave Eurolochbox 	HEIGHT ADAPTER ›CP LIFT‹ <ul style="list-style-type: none"> • aluminium • for 1 1/8" • height adjustable by 1 x 5 mm and 3 x 10 mm spacers • incl. ahead cap and screw • in M-Wave eurohole box 	<p>Tested by the manufacturer based on ISO 4210 MTB</p> 
--------	--	---	---

ART.-NR. UVP	BESCHREIBUNG	DESCRIPTION	
	VERSTELLBARER AHEAD LENKERVORBAU <ul style="list-style-type: none"> • getestet gemäß DIN EN 15194 und zusätzlich nach dem höheren Standard der Klasse 2 bis 140 kg • Aluminium • von 0°- 90° verstellbar • Lenkerklemmung für Ø 31,8 mm • 1½" (28,6 mm) • mattschwarz 	ADJUSTABLE AHEAD HANDLE STEM <ul style="list-style-type: none"> • tested based on DIN EN 15194 and also based on the higher standard of the class 2 up to 140 kg • aluminium • adjustable from 0°- 90° • clamp for Ø 31.8 mm • 1½" (28.6 mm) • matt black 	<div style="border: 1px solid black; padding: 2px; font-size: 8px;"> Tested by the manufacturer based on DIN EN 15194 </div> 
	auf M-Wave Eurolochkarte	on M-Wave eurohole card	
400319	90 mm	90 mm	
400320	110 mm	110 mm	
	Montageverpackung	OEM	
400317	90 mm	90 mm	
400318	110 mm	110 mm	
	22,90 €		





	AHEAD LENKERVORBAU ›ST-C2.1‹ <ul style="list-style-type: none"> • Aluminium, 3D geschmiedet • Lenkerklemmung für Ø 35 mm • 1½" (28,6 mm) • -12° • mattschwarz • auf M-Wave Eurolochkarte 	AHEAD HANDLE STEM ›ST-C2.1‹ <ul style="list-style-type: none"> • aluminium, 3D forged • clamp for Ø 35 mm • 1½" (28.6 mm) • -12° • matt black • on M-Wave eurohole card 	 
404320 U	40 mm	40 mm	
404322 U	50 mm	50 mm	
	34,90 €		

	AHEAD LENKERVORBAU ›ST-M4.1‹ <ul style="list-style-type: none"> • Aluminium, 3D geschmiedet • 1½" (28,6 mm) • 0° • Klemmhöhe: 43 mm • Lenkerklemmung für Ø 31,8 mm • mattschwarz 	AHEAD HANDLE STEM ›ST-M4.1‹ <ul style="list-style-type: none"> • aluminium, 3D forged • 1½" (28.6 mm) • 0° • stack height: 43 mm • clamp for Ø 31.8 • matt black 	<div style="border: 1px solid black; padding: 2px; font-size: 8px;"> Tested by the manufacturer based on ISO 4210 </div>  
	auf M-Wave Eurolochkarte	on M-Wave eurohole card	
400447	35 mm	35 mm	
400448	50 mm	50 mm	
	Montageverpackung	OEM	
400449	35 mm	35 mm	
400450	50 mm	50 mm	
	36,90 €		

ART.-NR. UVP	BESCHREIBUNG	DESCRIPTION	
	AHEAD LENKERVORBAU ›ST-M4.2‹ <ul style="list-style-type: none"> • Aluminium, 3D geschmiedet • 1 1/8" (28,6 mm) • 0° • Klemmhöhe: 36 mm • Lenkerklemmung für Ø 31,8 mm • mattschwarz 	AHEAD HANDLE STEM ›ST-M4.2‹ <ul style="list-style-type: none"> • aluminium, 3D forged • 1 1/8" (28.6 mm) • 0° • stack height: 36 mm • clamp for Ø 31.8 mm • matt black 	<div style="border: 1px solid black; padding: 2px; font-size: 8px;">Tested by the manufacturer based on ISO 4210</div> 
	auf M-Wave Eurolochkarte	on M-Wave eurohole card	
400466	35 mm	35 mm	
400467	50 mm	50 mm	
	Montageverpackung	OEM	
400468	35 mm	35 mm	
400469	50 mm	50 mm	
	25,90 €		

	AHEAD LENKERVORBAU <ul style="list-style-type: none"> • Aluminium, 3D geschmiedet • 1 1/8" (28,6 mm) • Lenkerklemmung für Ø 31,8 mm • ab 113 g • mattschwarz 	AHEAD HANDLE STEM <ul style="list-style-type: none"> • aluminium, 3D forged • 1 1/8" (28.6 mm) • clamp for Ø 31.8 mm • from 113 g • matt black 	<div style="border: 1px solid black; padding: 2px; font-size: 8px;">Tested by the manufacturer based on ISO 4210</div> 
	›ST-M3.1‹ 7°	›ST-M3.1‹ 7°	
	auf M-Wave Eurolochkarte	on M-Wave eurohole card	
404520	60 mm	60 mm	
404522	90 mm	90 mm	
404524	100 mm	100 mm	
404526	110 mm	110 mm	
	Montageverpackung	OEM	
404521	60 mm	60 mm	
404523	90 mm	90 mm	
404525	100 mm	100 mm	
404527	110 mm	110 mm	
	16,90 €		

	›ST-M3.2‹ 35°	›ST-M3.2‹ 35°	
	auf M-Wave Eurolochkarte	on M-Wave eurohole card	
404351	60 mm	60 mm	
404353	80 mm	80 mm	
404355	100 mm	100 mm	
404357	120 mm	120 mm	
	Montageverpackung	OEM	
404350	60 mm	60 mm	
404352	80 mm	80 mm	
404354	100 mm	100 mm	
404356	120 mm	120 mm	
	21,90 €		

ART.-NR. UVP	BESCHREIBUNG	DESCRIPTION	
	AHEAD LENKERVORBAU ›ASTEM 3D‹ <ul style="list-style-type: none"> • Aluminium, 3D geschmiedet • 1½" (28,6 mm) • 7° • Lenkerklemmung für Ø 31,8 mm • mit rostgeschützten Schrauben • mattschwarz 	AHEAD HANDLE STEM ›ASTEM 3D‹ <ul style="list-style-type: none"> • aluminium, 3D forged • 1½" (28.6 mm) • 7° • clamp for Ø 31.8 mm • with rust protected screws • matt black 	<div style="border: 1px solid black; padding: 2px; font-size: 8px;"> Tested by the manufacturer based on ISO 4210 </div>
	auf M-Wave Eurolochkarte	on M-Wave eurohole card	
404376	60 mm (nur 118,5 g)	60 mm (only 118.5 g)	
404253	90 mm	90 mm	
404258	100 mm	100 mm	
404277	110 mm	110 mm	
	Montageverpackung	OEM	
404208	60 mm	60 mm	
404283	90 mm	90 mm	
404284	100 mm	100 mm	
404285	110 mm	110 mm	
	11,90 €		

Handlebars & Accessories

	AHEAD LENKERVORBAU ›ST-M3.3‹ <ul style="list-style-type: none"> • Aluminium, 3D geschmiedet • 1½" (28,6 mm) • 7° • Lenkerklemmung für Ø 25,4 mm • mattschwarz 	AHEAD HANDLE STEM ›ST-M3.3‹ <ul style="list-style-type: none"> • aluminium, 3D forged • 1½" (28.6 mm) • 7° • clamp for Ø 25.4 mm • matt black 	<div style="border: 1px solid black; padding: 2px; font-size: 8px;"> Tested by the manufacturer based on ISO 4210 </div>
	auf M-Wave Eurolochkarte	on M-Wave eurohole card	
404400	60 mm	60 mm	
404401	90 mm	90 mm	
404402	105 mm	105 mm	
	Montageverpackung	OEM	
404403	60 mm	60 mm	
404404	90 mm	90 mm	
404405	105 mm	105 mm	
	17,90 €		

ART.-NR. BESCHREIBUNG
UVP

DESCRIPTION

INNER BAR ENDS

INNER BAR ENDS

- 408060 LENKERZUSATZGRIFF ›BE ANATOM IN‹**
14,90 €
- zur **Befestigung innen am Lenker** für **aerodynamische Fahrposition**
 - **anatomische** Form
 - einteilig
 - **Aluminium**
 - schwarz
 - mit Klemmung für Ø 22,2 mm
 - auf M-Wave Eurolochkarte

- BAR END ›BE ANATOM IN‹**
- for **fixing at the innerside of the handlebar** for **aerodynamic driving position**
 - **anatomic** shape
 - one-piece
 - **aluminium**
 - black
 - with clamp for Ø 22.2 mm
 - on M-Wave eurohole card

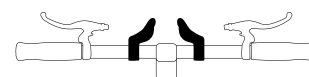

OUTER BAR ENDS

OUTER BAR ENDS

- 408231 LENKERZUSATZGRIFF ›BE TOOL‹**
18,90 €
- **Aluminium**
 - mattschwarz
 - **Werkzeugset im Inneren mit 15 Funktionen:**
4/5/6/8 mm Innensechskantschlüssel
T 25 Vielzahnschlüssel
14G/0,136" Speichenschlüssel
Kreuz-/Schlitzschraubendreher
8/9/10 mm Ring-/Maulschlüssel
Kettennietdrücker
2 Reifenheber
 - in M-Wave Blisterverpackung

- BAR END ›BE TOOL‹**
- **aluminium**
 - matt black
 - **tool set inside with 15 functions:**
4/5/6/8 mm allen keys
T 25 star screwdriver
14G/0.136" spoke wrench
Phillips/flat type screwdriver
8/9/10 mm round wrench
chain riveting tool
2 tire levers
 - in M-Wave blister packaging

according to ISO 4210



- 408167 LENKERZUSATZGRIFF ›BE ANATOM‹**
8,90 €
- **anatomische Form**
 - einteilig
 - **Aluminium**
 - schwarz
 - mit Außenklemmung
 - auf M-Wave Eurolochkarte

- BAR END ›BE ANATOM‹**
- **anatomic shape**
 - one-piece
 - **aluminium**
 - black
 - with outer clamp
 - on M-Wave eurohole card



- 408113 LENKERZUSATZGRIFF ›M-WAVE‹**
6,90 €
- gerade, kurze Ausführung
 - **Aluminium**
 - mit Außenklemmung
 - **anatomische** Kappe
 - mattschwarz
 - Montageverpackung

- BAR END ›M-WAVE‹**
- straight, short type
 - **aluminium**
 - with outer clamp
 - **anatomic** cap
 - matt black
 - OEM



ART.-NR. UVP **BESCHREIBUNG**

DESCRIPTION

410831 **LENKERBAND**
 ›CLOUD TAPE BASE‹
 8,90 €

 • **strukturierte Non-Slip-Oberfläche** bietet angenehmes und sicheres Griffgefühl
 • extra **lang** und **breit: 200 x 3 cm**
 • 1 Set = 2 Bänder
 • mit Lenkerendstopfen und Klebeband
 • in M-Wave Eurolochbox

HANDLEBAR TAPE
 ›CLOUD TAPE BASE‹
 • **structured non-slip surface** provides pleasant and secure grip
 • extra **long** and **wide: 200 x 3 cm**
 • 1 set = 2 tapes
 • with handlebar plugs and adhesive tapes
 • in M-Wave eurohole box

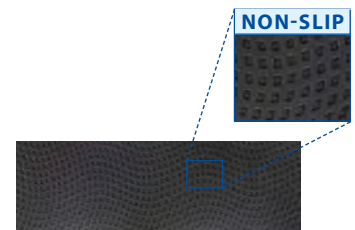

LENKERENDSTOPFEN ›A RIO‹
 • aus **Aluminium** mit **Nirosta-Schraube**
 • für Innendurchmesser 17,5 - 19,5 mm
 • 1 Paar auf M-Wave Eurolochkarte

HANDLEBAR PLUGS ›A RIO‹
 • made of **aluminium** with **stainless steel screw**
 • for inner diameter 17.5 - 19.5 mm
 • 1 pair on M-Wave eurohole card



410894 blau eloxiert

blue anodised

410895 grün eloxiert

green anodised

7,90 €

LENKERENDSTOPFEN
 ›FIT-PLUGS‹

- aus **elastischem TPR Kunststoff**
- durch **Flexibilität** passend für **viele verschiedene Innendurchmesser**
- wiederverwendbar

HANDLEBAR PLUGS
 ›FIT-PLUGS‹
 • made of **elastic TPR plastic**
 • due to **flexibility** suitable for **many different inner diameters**
 • reusable



410897 1 Set = 4 Stück auf M-Wave Eurolochkarte

1 set = 4 pieces on M-Wave eurohole card

1,90 € / set

410898 100 Stück im Polybeutel

100 pieces in PE bag

0,49 €

SCHRAUBGRIFF
 ›CLOUD BASE 2‹
 • **anatomisch geformter Echtlederoptik-Schraubgriff**
 • **handgenäht**
 • leichte (De-)Montage und **fester Halt** am Lenker durch **doppelte Aluminium-Schraubbefestigung**
 • mit Lenkerendstopfen
 • 135 mm

SCREW-ON GRIP
 ›CLOUD BASE 2‹
 • **anatomically shaped genuine leather design screw-on grip**
 • **handsewn**
 • easy (dis-)assembly and **perfect grip** at the handlebar through **double aluminium screw attachment**
 • with handlebar plugs
 • 135 mm



410622 auf M-Wave Eurolochkarte

on M-Wave eurohole card

410610 paarweise im Polybeutel

1 pair in PE bag

13,90 € / pair

SCHRAUBGRIFF
 ›CLOUD BUFF FIX‹
 • **anatomisch geformter Echtlederoptik-Schraubgriff**
 • leichte (De-)Montage und **fester Halt** am Lenker durch **doppelte Aluminium-Schraubbefestigung**
 • mit elastischen Lenkerendstopfen

SCREW-ON GRIP
 ›CLOUD BUFF FIX‹
 • **anatomically shaped genuine leather design screw-on grip**
 • easy (dis-)assembly and **perfect grip** at the handlebar through **double aluminium screw attachment**
 • with elastic handlebar plugs



138 / 138 mm

138 / 138 mm

410628 auf M-Wave Eurolochkarte

on M-Wave eurohole card

410603 paarweise im Polybeutel

1 pair in PE bag

138 / 99 mm

138 / 99 mm

410629 auf M-Wave Eurolochkarte

on M-Wave eurohole card



410604 paarweise im Polybeutel



1 pair in PE bag



13,90 € / pair

ART.-NR. UVP	BESCHREIBUNG	DESCRIPTION	
	GRIFF ›CLOUD BUFF‹ <ul style="list-style-type: none"> • anatomisch geformter Echtlederoptikgriff • handgenäht • geschlossenes Ende • 125 mm 	GRIP ›CLOUD BUFF‹ <ul style="list-style-type: none"> • anatomically shaped genuine leather design grip • handsewn • closed end • 125 mm 	
410589	auf M-Wave Eurolochkarte	on M-Wave eurohole card	
410588	paarweise im Polybeutel	1 pair in PE bag	
7,90 € / pair			

	BESCHREIBUNG	DESCRIPTION		
	SCHRAUBGRIFF ›CLOUD ERGO MAX FIX BE‹ <ul style="list-style-type: none"> • Komfortgriff mit extra großer ergonomischer Auflagefläche, die dem Abknicken der Handgelenke vorbeugt • Zweikomponentengriff: harte Mischung innen und weiche Mischung außen für Komfort und Stoßabsorbierung • Microtech Noppen für noch besseren Halt • Aluminium-Klemme und integrierte 2-fache Schraubbefestigung für leichte (De-)Montage und besonders festem Halt am Lenker • mit Lenkerendstopfen • 140 mm 	SCREW-ON GRIP ›CLOUD ERGO MAX FIX BE‹ <ul style="list-style-type: none"> • comfort grip with especially wide ergonomic contact area, which prevents the wrists from deviating • 2-Component grip: hard inner mixture and soft outer mixture for comfort and shock absorbing • Microtech knobs for still better grip • aluminium clamp and integrated double screw attachment for easy (dis-)assembly and perfect grip at the handlebar • with handlebar plugs • 140 mm 		
	410124	auf M-Wave Eurolochkarte		on M-Wave eurohole card
	410125	im Polybeutel		in PE bag
29,90 € / pair				

	BESCHREIBUNG	DESCRIPTION		
	SCHRAUBGRIFF ›CLOUD ERGOMAX FIX‹ <ul style="list-style-type: none"> • fest integrierte Schraubbefestigung für leichte (De-)Montage und festem Halt am Lenker • Komfortgriff mit ergonomischer Form, die dem Abknicken der Handgelenke vorbeugt • Zweikomponentengriff: harte Mischung innen und weiche Mischung außen für Komfort und Stoßabsorbierung • Microtech Noppen für noch besseren Halt • geschlossenes Ende • 138 mm 	SCREW-ON GRIP ›CLOUD ERGOMAX FIX‹ <ul style="list-style-type: none"> • firmly integrated screw attachment for easy (dis-)assembly and perfect grip at the handlebar • comfort grip with ergonomic shape, which prevents the wrists from deviating • 2-Component grip: hard inner mixture and soft outer mixture for comfort and shock absorbing • Microtech knobs for still better grip • closed end • 138 mm 		
	410053	auf M-Wave Eurolochkarte		on M-Wave eurohole card
	410052	im Polybeutel		in PE bag
11,90 € / pair				

	BESCHREIBUNG	DESCRIPTION	
	SCHRAUBGRIFF ›CLOUD ERGO FIX 2‹ <ul style="list-style-type: none"> • leichte (De-)Montage und fester Halt am Lenker durch doppelte Schraubbefestigung • anatomische Form • mit Lenkerendstopfen • 130 mm 	SCREW-ON GRIP ›CLOUD ERGO FIX 2‹ <ul style="list-style-type: none"> • easy (dis-)assembly and perfect grip at the handlebar through double screw attachment • anatomic shape • with handlebar plugs • 130 mm 	
410402	auf M-Wave Eurolochkarte	on M-Wave eurohole card	
410236	paarweise im Polybeutel	1 pair in PE bag	
9,90 € / pair			

ART.-NR. BESCHREIBUNG
UVP

DESCRIPTION

DOUBLE
D2
DENSITY

SCHRAUBGRIFF
›CLOUD ERGO FIX‹

- **fest integrierte Schraubbefestigung** für leichte (De-)Montage und festem Halt am Lenker
- Komfortgriff mit **ergonomischer Form**, die dem Abknicken der Handgelenke vorbeugt
- **fließender Übergang** zur Klemme
- **Zweikomponentengriff D2**: harte Mischung innen und weiche Mischung außen für Komfort und Stoßabsorbierung
- **Microtech Noppen** für noch besseren Halt
- geschlossenes Ende

132 / 132 mm

410054 auf M-Wave Eurolochkarte

410055 im Polybeutel

10,90 € / pair

132 / 92 mm
92 mm mit **Innenklemmung**

410056 auf M-Wave Eurolochkarte

410057 im Polybeutel

13,90 € / pair

SCREW-ON GRIP
›CLOUD ERGO FIX‹

- **firmly integrated screw attachment** for easy (dis-)assembly and perfect grip at the handlebar
- comfort grip with **ergonomic shape**, which prevents the wrists from deviating
- **smooth transition** to the clamp
- **2-Component grip D2**: hard inner mixture and soft outer mixture for comfort and shock absorbing
- **Microtech knobs** for still better grip
- closed end

132 / 132 mm

on M-Wave eurohole card

in PE bag

132 / 92 mm
92 mm with **inner clamp**

on M-Wave eurohole card

in PE bag



FIX

bottom view:



MICROTECH
KNOBS



132 mm 92 mm



FIX

SCHRAUBGRIFF
›CLOUD BASE 2 FIX‹

- **integrierte Schraubbefestigung** für leichte (De-)Montage und festem Halt am Lenker
- Komfortgriff mit **ergonomischer Form**, die dem **Abknicken der Handgelenke** vorbeugt
- **Zweikomponentengriff**: harte Mischung innen für guten Halt auf dem Lenker und weiche Mischung außen für Komfort und Stoßabsorbierung
- geschlossenes Ende

135 / 135 mm

410121 auf M-Wave Eurolochkarte

410126 paarweise im Polybeutel

135 / 100 mm

410122 auf M-Wave Eurolochkarte

410127 paarweise im Polybeutel

5,90 € / pair

SCREW-ON GRIP
›CLOUD BASE 2 FIX‹

- **integrated screw attachment** for easy (dis-)assembly and perfect grip at the handlebar
- comfort grip with **ergonomic shape**, which prevents the **wrists from deviating**
- **2-Component grip**: hard inner mixture for good connection with handlebar and soft outer mixture for comfort and shock absorbing
- closed end

135 / 135 mm

on M-Wave eurohole card

1 pair in PE bag

135 / 100 mm

on M-Wave eurohole card



1 pair in PE bag



FIX



135 mm 100 mm

ART.-NR. UVP	BESCHREIBUNG	DESCRIPTION	
	SCHRAUBGRIFF ›CLOUD SLICK FIX 2‹ <ul style="list-style-type: none"> • Zweikomponenten-Schraubgriff • leichte (De-)Montage und fester Halt am Lenker durch doppelte Aluminium-Schraubbefestigung • mit Lenkerendstopfen • 130 mm 	SCREW-ON GRIP ›CLOUD SLICK FIX 2‹ <ul style="list-style-type: none"> • 2-Component screw-on grip • easy (dis-)assembly and perfect grip at the handlebar through double aluminium screw attachment • with handlebar plugs • 130 mm 	
410401	auf M-Wave Eurolochkarte	on M-Wave eurohole card	
410489	paarweise im Polybeutel 10,90 € / pair	1 pair in PE bag	
	SCHRAUBGRIFF ›CLOUD SLICK FIX‹ <ul style="list-style-type: none"> • leichte (De-)Montage und fester Halt am Lenker durch doppelte Schraubbefestigung • 130 mm • mit Lenkerendstopfen 	SCREW-ON GRIP ›CLOUD SLICK FIX‹ <ul style="list-style-type: none"> • easy (dis-)assembly and perfect grip at the handlebar through double screw attachment • 130 mm • with handlebar plugs 	
410403	auf M-Wave Eurolochkarte	on M-Wave eurohole card	
410480	paarweise im Polybeutel 6,90 € / pair	1 pair in PE bag	
	SCHRAUBGRIFF ›CLOUD SLICK FIX 4‹ <ul style="list-style-type: none"> • ergonomische Form • leichte (De-)Montage und fester Halt am Lenker durch Schraubbefestigung • rutschfeste Gummigriffe • mit Lenkerendstopfen • 130 mm 	SCREW-ON GRIP ›CLOUD SLICK FIX 4‹ <ul style="list-style-type: none"> • ergonomic shape • easy (dis-)assembly and perfect grip at the handlebar through screw attachment • non-slip rubber grips • with handlebar plugs • 130 mm 	
410123	auf M-Wave Eurolochkarte	on M-Wave eurohole card	
410120	paarweise im Polybeutel 5,90 € / pair	1 pair in PE bag	
	SCHRAUBGRIFF ›CLOUD SLICK FIX 6‹ <ul style="list-style-type: none"> • leichte (De-)Montage und fester Halt am Lenker durch Aluminium-Schraubbefestigung • Zweikomponentengriff: harte Mischung innen für guten Halt auf dem Lenker und weiche Mischung außen für Komfort und Stoßabsorbierung • mit Lenkerendstopfen • 130 mm 	SCREW-ON GRIP ›CLOUD SLICK FIX 6‹ <ul style="list-style-type: none"> • easy (dis-)assembly and perfect grip at the handlebar through aluminium screw attachment • 2-Component grip: hard inner mixture for good connection with handlebar and soft outer mixture for comfort and shock absorbing • with handlebar plugs • 130 mm 	
410617	auf M-Wave Eurolochkarte	on M-Wave eurohole card	
410618	paarweise im Polybeutel 6,90 € / pair	1 pair in PE bag	

ART.-NR. BESCHREIBUNG
UVP

DESCRIPTION

DOUBLE
D2
DENSITY

SCHRAUBGRIFF
›CLOUD SLICK SHORT‹

- **extra kurzer Griff: 115 mm**
- für kleine Hände
- **fest integrierte Kunststoff-Schraubbefestigung** für leichte (De-)Montage und festem Halt am Lenker
- **Zweikomponentengriff:** harte Mischung innen für guten Halt auf dem Lenker und weiche Mischung außen für Komfort und Stoßabsorbierung
- geschlossenes Ende
- besonders geeignet für E-Scooter

115
mm

SCREW-ON GRIP
›CLOUD SLICK SHORT‹

- **extra short grip: 115 mm**
- for small hands
- **firmly integrated plastic screw attachment** for easy (dis-)assembly and perfect grip at the handlebar
- **2-Component grip:** hard inner mixture for good connection with handlebar and soft outer mixture for comfort and shock absorbing
- closed end
- especially suitable for e-scooters



410316 auf M-Wave Eurolochkarte

on M-Wave eurohole card

410317 im Polybeutel

in PE bag

8,90 € / pair

78 g

SCHAUMSTOFF-SCHRAUBGRIFF
›CLOUD SLICK FIX LIGHT‹

- harte Mischung innen für **guten Halt** auf dem Lenker und **superleichte**, weiche Schaumstoffauflage außen für **Komfort** und **Stoßabsorbierung**
- leichte (De-)Montage und **fester Halt** am Lenker durch **doppelte Aluminium-Schraubbefestigung**
- nur **78 g/Pair**
- mit Lenkerendstopfen
- 130 mm

SOFT
FOAM

FOAM SCREW-ON GRIP
›CLOUD SLICK FIX LIGHT‹

- hard inner mixture for **good connection** with handlebar and **super light** soft foam outer mixture for **comfort** and **shock absorbing**
- easy (dis-)assembly and **perfect grip** at the handlebar through **double aluminium screw attachment**
- only **78 g/pair**
- with handlebar plugs
- 130 mm



410404 auf M-Wave Eurolochkarte

on M-Wave eurohole card

410318 paarweise im Polybeutel

1 pair in PE bag

5,90 € / pair

SILICONE

GRIFF ›CLOUD SLICK FIX 5‹

- **100 % Silikon**
- rutschfest
- sehr angenehme **Haptik**
- stoßabsorbierend
- **asymmetrische Form** ermöglicht individuelle Positionierung
- langlebig, da **UV-beständig** und waschbar
- temperaturunempfindlich
- 130 mm
- mit Lenkerendstopfen

GRIP ›CLOUD SLICK FIX 5‹

- **100 % silicone**
- non-slip
- very pleasant **haptics**
- shock absorbing
- **asymmetric form** enables individual positioning
- long lasting because **UV-resistant** and washable
- temperature insensitive
- 130 mm
- with handlebar plugs



410700 paarweise im Polybeutel

1 pair in PE bag

410701 auf M-Wave Eurolochkarte

on M-Wave eurohole card

12,90 € / pair

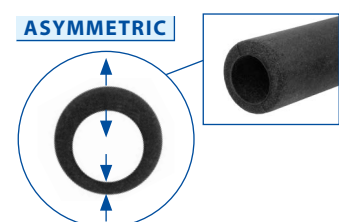

ART.-NR. **BESCHREIBUNG**
UVP

DESCRIPTION



GRIF ›SLR‹

- sehr angenehme **Haptik**
- **atmungsaktiv** und **temperaturunempfindlich**
- stoßabsorbierend
- nur **30 g/Paar** durch **SLR (Super Light Rubber)**
- mit Lenkerendstopfen
- 130 mm

GRIP ›SLR‹

- very pleasant **haptics**
- **breathable** and **temperature insensitive**
- shock absorbing
- only **30 g/pair** by **SLR (Super Light Rubber)**
- with handlebar plugs
- 130 mm



411010 auf M-Wave Eurolochkarte

on M-Wave eurohole card

411000 paarweise im Polybeutel
4,90 € / pair

1 pair in PE bag



GRIF ›CLOUD ERGO‹

- Komfortgriff mit **ergonomischer Form**, die dem **Abknicken** der **Handgelenke** vorbeugt
- **Zweikomponentengriff D2**: harte Mischung innen für guten Halt auf dem Lenker und weiche Mischung außen für Komfort und Stoßabsorbierung
- 132 mm

GRIP ›CLOUD ERGO‹

- comfort grip with **ergonomic shape**, which prevents the **wrists** from **bending**
- **2-Component grip D2**: hard inner mixture for good connection with handlebar and soft outer mixture for comfort and shock absorbing
- 132 mm



410039 auf M-Wave Eurolochkarte

on M-Wave eurohole card

410040 paarweise im Polybeutel
6,90 € / pair

1 pair in PE bag

GRIF ›CLOUD BASE 3‹

- schwarz/grau
- Komfortgriff mit **ergonomischer Form**, die dem **Abknicken** der **Handgelenke** vorbeugt
- geschlossenes Ende
- 125 mm

GRIP ›CLOUD BASE 3‹

- black/grey
- comfort grip with **ergonomic shape**, which prevents the **wrists** from **bending**
- closed end
- 125 mm



410531 auf M-Wave Eurolochkarte

on M-Wave eurohole card

410530 paarweise im Polybeutel
5,90 € / pair

1 pair in PE bag



GRIF ›FAT BOY‹

- **Zweikomponentengriff**
- schwarz/grau
- **weich** und **griffig**
- geschlossenes Ende
- 125 mm

GRIP ›FAT BOY‹

- **2-Component grip**
- black/grey
- **soft** and **handy**
- closed end
- 125 mm





410201 auf M-Wave Eurolochkarte

on M-Wave eurohole card

410229 paarweise im Polybeutel
4,90 € / pair

1 pair in PE bag

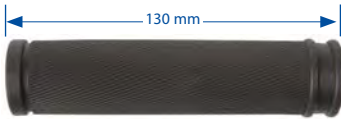
ART.-NR. UVP	BESCHREIBUNG	DESCRIPTION	
	MTB GRIFF ›CLOUD BASE 1‹ <ul style="list-style-type: none"> • Zweikomponentengriff: harte Mischung innen für guten Halt auf dem Lenker und weiche Mischung außen für Komfort, Stoßabsorbierung und zuverlässigen Halt • 130 mm 	MTB GRIP ›CLOUD BASE 1‹ <ul style="list-style-type: none"> • 2-Component grip: hard inner mixture for good connection with the handlebar and soft outer mixture for comfort, shock absorbing and perfect grip • 130 mm 	
410203	auf M-Wave Eurolochkarte	on M-Wave eurohole card	
410260	paarweise im Polybeutel 4,90 € / pair	1 pair in PE bag	
	ERGOGRIFFF ›CLOUD BASE 4‹ <ul style="list-style-type: none"> • Komfortgriff mit ergonomischer Form, die dem Abknicken der Handgelenke vorbeugt • geschlossenes Ende • 130 mm 	ERGO GRIP ›CLOUD BASE 4‹ <ul style="list-style-type: none"> • comfort grip with ergonomic shape, which prevents the wrists from bending • closed end • 130 mm 	
410233	auf M-Wave Eurolochkarte	on M-Wave eurohole card	
410231	paarweise im Polybeutel 3,90 € / pair	1 pair in PE bag	
	GRIFF ›CLOUD BASE 2‹ <ul style="list-style-type: none"> • Komfortgriff mit ergonomischer Form, die dem Abknicken der Handgelenke vorbeugt • geschlossenes Ende 	GRIP ›CLOUD BASE 2‹ <ul style="list-style-type: none"> • comfort grip with ergonomic shape, which prevents the wrists from bending • closed end 	
410524	auf M-Wave Eurolochkarte	on M-Wave eurohole card	
410523	paarweise im Polybeutel	1 pair in PE bag	
410539	auf M-Wave Eurolochkarte	on M-Wave eurohole card	
410540	paarweise im Polybeutel	1 pair in PE bag	
410522	auf M-Wave Eurolochkarte	on M-Wave eurohole card	
410521	paarweise im Polybeutel 3,90 € / pair	1 pair in PE bag	
	GRIFF ›ERGOGEL‹ <ul style="list-style-type: none"> • Komfortgriff mit ergonomischer Form, die dem Abknicken der Handgelenke vorbeugt • Negativprofil gibt bei Nässe Halt • mit Lenkerendstopfen 	GRIP ›ERGOGEL‹ <ul style="list-style-type: none"> • comfort grip with ergonomic shape, which prevents the wrists from bending • negative profile avoids additional slipping at wet conditions • with handlebar plugs 	
410527	paarweise im Polybeutel	1 pair in PE bag	
410528	paarweise im Polybeutel	1 pair in PE bag	
410529	auf M-Wave Eurolochkarte	on M-Wave eurohole card	

ART.-NR. UVP	BESCHREIBUNG	DESCRIPTION	
	GRIF F ›CLOUD TIRE 1‹ <ul style="list-style-type: none"> • schwarz • griffige Feinnoppen-Struktur gibt guten Halt • geschlossenes Ende • 125 mm 	GRIP ›CLOUD TIRE 1‹ <ul style="list-style-type: none"> • black • non-slip fine knob structure gives good grip • closed end • 125 mm 	
410212	auf M-Wave Eurolochkarte	on M-Wave eurohole card	
410262	paarweise im Polybeutel 3,90 € / pair	1 pair in PE bag	
	GRIF F ›CLOUD SLICK‹ <ul style="list-style-type: none"> • schwarz • geschlossenes Ende • 130 / 85 mm 	GRIP ›CLOUD SLICK‹ <ul style="list-style-type: none"> • black • closed end • 130 / 85 mm 	 
410213	auf M-Wave Eurolochkarte	on M-Wave eurohole card	
410263	paarweise im Polybeutel 3,90 € / pair	1 pair in PE bag	
	130 mm	130 mm	
410214	auf M-Wave Eurolochkarte	on M-Wave eurohole card	
410264	paarweise im Polybeutel 3,90 € / pair	1 pair in PE bag	
	GRIF F ›CLOUD TIRE 2‹ <ul style="list-style-type: none"> • griffige Struktur gibt guten Halt • geschlossenes Ende • 120 mm 	GRIP ›CLOUD TIRE 2‹ <ul style="list-style-type: none"> • non-slip structure gives good grip • closed end • 120 mm 	
410241	auf M-Wave Eurolochkarte	on M-Wave eurohole card	
410242	paarweise im Polybeutel 2,90 € / pair	1 pair in PE bag	
	 GRIF F ›HEXFOAM‹ <ul style="list-style-type: none"> • hexagonale Form • nur 44 g/Paar • aus leichtem High-Density-Schaum • mit Lenkerendstopfen • 125 mm 	GRIP ›HEXFOAM‹ <ul style="list-style-type: none"> • hexagonal shape • only 44 g/pair • light high density foam • with handlebar plugs • 125 mm 	 
410555	auf M-Wave Eurolochkarte	on M-Wave eurohole card	
410556	Montageverpackung 3,90 € / pair	OEM	

ART.-NR. UVP **BESCHREIBUNG** **DESCRIPTION**



KUPFERKLINGEL ›BELLA C-YELL‹

- **sehr lauter und langanhaltender Klang (85 dB)**
- Ø 30 mm
- inkl. 3M Einlegegummi
- in M-Wave Eurolochbox

COPPER BELL ›BELLA C-YELL‹

- **very loud and long lasting sound (85 dB)**
- Ø 30 mm
- incl. 3M rubber inlay
- in M-Wave eurohole box



420451 • schwarz
• gemäß **DIN 33946 für E-Bikes zugelassen**

• black
• **approved for e-bikes according to DIN 33946**

420450 silber
11,90 €

silver

420061 MESSINGKLINGEL ›BELLA SUPER MINI‹

6,90 €



- XS-Klingel, Ø 23 mm
- sehr **lauter und langanhaltender** Klang
- Klingel vom Halter **abnehmbar**
- verstellbarer **Universalhalter** von Ø 22 - 31,8 mm
- schwarz
- auf M-Wave Eurolochkarte



BRASS BELL ›BELLA SUPER MINI‹

- XS bell, Ø 23 mm
- very **loud and long lasting** sound
- bellbody **detachable**
- adjustable **universal bracket** from Ø 22 - 31.8 mm
- black
- on M-Wave eurohole card



MESSINGKLINGEL ›BELLA DING-DONG‹



- Ø 33 mm
- sehr **lauter und langanhaltender** Klang
- auf M-Wave Eurolochkarte

BRASS BELL ›BELLA DING-DONG‹

- Ø 33 mm
- very **loud and long lasting** sound
- on M-Wave eurohole card

420053 messing

brass

420099 silber

silver

420098 schwarz
4,90 €

black



MINIKLINGEL ›SOCCER‹

- **Aluminium**
- mit „Schuh“-Federklöppel
- im **Länderflaggen-Design**
- ca. Ø 38 mm
- auf M-Wave Eurolochkarte

MINI BELL ›SOCCER‹

- **aluminium**
- with "shoe" spring lever
- in **national flag design**
- approx. Ø 38 mm
- on M-Wave eurohole card

420201 Deutschland

Germany

420202 England, Österreich, Polen, Türkei
2,90 €

England, Austria, Poland, Turkey



Art. 420201



Art. 420202

ART.-NR. UVP	BESCHREIBUNG	DESCRIPTION	
	<p>MINIKLINGEL ›BELLA DOME‹</p> <ul style="list-style-type: none"> • ca. Ø 34 mm • lauter und langanhaltender Klang • 360° drehbar • universelle, schnelle und werkzeuglose Montage am Lenker, Vorbau, Gabelschaft, ... 	<p>MINI BELL ›BELLA DOME‹</p> <ul style="list-style-type: none"> • approx. Ø 34 mm • loud and long lasting sound • 360° turnable • universal, quick and toolless mounting at the handlebar, stem, steerer, ... 	
420063	<ul style="list-style-type: none"> • mit zusätzlichem Befestigungsring für unterschiedliche Ø • auf M-Wave Eurolochkarte 	<ul style="list-style-type: none"> • with additional mounting ring for different Ø • on M-Wave eurohole card 	
420068	Montageverpackung	OEM	
2,90 €			
420069	Ersatz-Befestigungsring, Ø 42 mm	replacement mounting ring, Ø 42 mm	
0,29 €			
420030	<p>MINIKLINGELSORTIMENT</p> <ul style="list-style-type: none"> • bedruckt • mit verschiedenen Motiven • im M-Wave Thekendisplay 	<p>MINI BELLS ASSORTMENT</p> <ul style="list-style-type: none"> • with imprints • in different designs • in M-Wave sales display 	
2,90 €			
	<p>MINIKLINGEL ›BELLA DESIGN‹</p> <ul style="list-style-type: none"> • Aluminium • ca. Ø 36 mm • sehr lauter und langanhaltender Klang • Klöppel 360° drehbar • mit metrischer Schraube <p>auf M-Wave Eurolochkarte</p>	<p>MINI BELL ›BELLA DESIGN‹</p> <ul style="list-style-type: none"> • aluminium • approx. Ø 36 mm • very loud and long lasting sound • lever 360° turnable • with metric screw <p>on M-Wave eurohole card</p>	
420067	gold	gold	
420066	schwarz	black	
420142	weiß	white	  
420143	rot	red	
420144	blau	blue	  
420145	grün	green	
420147	orange	orange	
420148	pink	pink	
1,90 €			
420064	schwarz, Montageverpackung	black, OEM	
1,90 €			

ART.-NR. UVP **BESCHREIBUNG** **DESCRIPTION**

MINIGLOCKE

- **Stahl**
- mit **metrischer Schraube**
- Klöppel 360° drehbar
- 20 Stück im **M-Wave Thekendisplay**

420026 ›BELLA MINI-BLACK‹

1,90 € schwarz

MINI BELL

- **steel**
- with **metric screw**
- lever 360° turnable
- 20 pieces in **M-Wave sales display**

›BELLA MINI-BLACK‹

black



420025 ›BELLA MINI-PASTEL‹

1,90 € • **Pastelltöne**, farbig sortiert
• weißes Unterteil

›BELLA MINI-PASTEL‹

- **pastel shades**, assorted colours
- white bottom



KLINGEL ›MAXI DING-DONG‹

- **Ø 80 mm**
- auf M-Wave Eurolochkarte

BELL ›MAXI DING-DONG‹

- **Ø 80 mm**
- on M-Wave eurohole card



420324 **Messing**, sehr **lauter** und lang **anhaltender** Klang
11,90 €

brass, very **loud** and long **lasting** sound

Stahl

420322 Fluo, mit **fluoreszierenden** Punkten, ca. 1 Std. Leuchtdauer
9,90 €

steel

Fluo, with **fluorescent** dots, approx. 1 h glowing time



420330 I Love My Bike

I Love My Bike

420325 Apps

Apps

420306 Newspaper

Newspaper

420307 Umbrella

Umbrella

420308 Sunflower

Sunflower

420320 Ladybird

Ladybird

420311 Smile

7,90 €

Smile



420313 sortiert, im M-Wave-Thekendisplay (8 Stück), Sortierung wird regelmäßig aktualisiert.
7,90 €

assorted, in M-Wave sales display (8 pcs), sorting will be updated regularly.



ART.-NR. UVP	BESCHREIBUNG	DESCRIPTION
	<p>KLINGEL ›BELLA TRILL‹</p> <ul style="list-style-type: none"> • schnelle Montage • mit nur einer M3 Schraube • Ø 53 mm • Aluminium <p>auf M-Wave Eurolochkarte</p>	<p>BELL ›BELLA TRILL‹</p> <ul style="list-style-type: none"> • fast assembling • with only one M3 screw • Ø 53 mm • aluminium <p>on M-Wave eurohole card</p>
420192	<ul style="list-style-type: none"> • für Rechtsmontage • schwarz • besonders geeignet für E-Bikes mit Display auf der linken Seite 	<ul style="list-style-type: none"> • for right side mounting • black • especially suitable for e-bikes with display on the left side
	<ul style="list-style-type: none"> • für Linksmontage 	<ul style="list-style-type: none"> • for left side mounting
420191	schwarz	black
420193	silber	silver
420152	weiß	white
420153	rot	red
420154	blau	blue
420155	grün	green
420157	orange	orange
420158	pink	pink
	Montageverpackung	OEM
420118	schwarz	black
420071	silber	silver
2,90 €		



Bells

420190	<p>KINDERKLINGELSORTIMENT</p> <p>2,90 €</p> <ul style="list-style-type: none"> • Stahl • farbig sortiert • mit verschiedenen Kindermotiven • 12 Stück im M-Wave Thekendisplay 	<p>CHILDREN BELLS ASSORTMENT</p> <ul style="list-style-type: none"> • steel • assorted colours • with different designs for kids • 12 pcs in M-Wave sales display
--------	--	--



ART.-NR. UVP	BESCHREIBUNG	DESCRIPTION
-----------------	--------------	-------------

- KLINGEL ›BELLA 3D‹**
- Stahl
 - mit verschiedenen **3D-Motiven**
 - Kunststoffunterteil mit 2 Schrauben

- BELL ›BELLA 3D‹**
- steel
 - with several **3D pictures**
 - plastic base with 2 screws

auf M-Wave Eurolochkarte

on M-Wave eurohole card

420138 Wassermelone

Watermelon

420139 Orange

Orange

420125 Black fancy

Black fancy

420124 White fancy

White fancy

420121 I love my bike

I love my bike

420123 Smile
2,90 €

Smile

420119 **Kinder-Klingeln**, farbig sortiert, 6 Stück in neutralem Karton

children bells, coloured assorted, 6 pieces in neutral box



Montageverpackung

OEM

420197 Horse

Horse

420198 Soccer

Soccer

420199 Smile
2,90

Smile

420270 **ELEKTRISCHE KLINGEL ›BELLECTRIC‹**

11,90 €



- Lautstärke **120 db**
- **werkzeuglose Montage**
- passend für Lenker mit Ø **22,2 - 31,8 mm**
- **wasserfest**
- inkl. Batterie (Art. 640824)
- in M-Wave Blisterverpackung
- 20 Stück im **M-Wave Thekendisplay**

ELECTRO BELL ›BELLECTRIC‹

- loudness **120 db**
- **toolless mounting**
- suitable for handlebars with Ø **22.2 - 31.8 mm**
- **waterproof**
- incl. battery (art. 640824)
- in M-Wave blister packaging
- 20 pcs in **M-Wave sales display**



Verkauf und Nutzung im Geltungsbereich der StVZO (Deutschland) unzulässig (Abgabe nur an außerdeutsche Kunden).

ART.-NR. UVP **BESCHREIBUNG**

DESCRIPTION

430744 FAHRRADSTÄNDER
 13,90 €
›STRONG R III‹

- zur Montage am Hinterbau
- **Aluminium**
- Länge werkzeuglos **verstellbar** für 26" - 29"
- **universell einstellbar für fast alle Hinterbauwinkel, Rohrdurchmesser und Scheibenbremsenden**
- mit **Gummifuß**
- auf M-Wave Eurolochkarte

SIDE STAND
›STRONG R III‹

- for rear stay
- **aluminium**
- length **adjustable** without tools for 26" - 29"
- **universally adjustable for almost all rear stay angles, tube diameters and disc brake ends**
- with **rubber foot**
- on M-Wave eurohole card

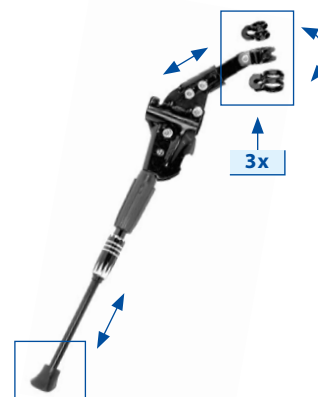

FAHRRADSTÄNDER

- **Aluminium**
- extra robuste Ausführung
- **verstellbar** von 24" - 29"
- besonders **für E-Bikes geeignet**
- mit **stabilem Sicherheitsfuß**
- inkl. Montagematerial
- für Montage an der Kettenstrebe

›COLUMN-E2‹

- **universell passend** für Lochabstand **40 mm und 18 mm**
- mit 2x M6 **Niro**-Befestigungsschrauben

SIDE STAND

- **aluminium**
- extra robust design
- **adjustable** from 24" - 29"
- especially **suitable for e-bikes**
- with **stable safety foot**
- incl. mounting material
- for assembling at the chain stay

›COLUMN-E2‹

- **universally suitable** for hole distance **40 mm and 18 mm**
- with 2x M6 **stainless steel** mounting screws



430849 Montageverpackung

OEM

430850 auf M-Wave Eurolochkarte
 18,90 €

on M-Wave eurohole card

›COLUMN-E1‹

- **passend** für Lochabstand **18 mm**
- mit Verdrehenschutz-Nut
- mit 2x M6 **Niro**-Befestigungsschrauben und Muttern

›COLUMN-E1‹

- **suitable** for hole distance **18 mm**
- anti-rotation slot
- with 2x M6 **stainless steel** mounting screws and nuts

430853 Montageverpackung

OEM

430854 auf M-Wave Eurolochkarte
 17,90 €

on M-Wave eurohole card



430925 FAHRRADSTÄNDER
 14,90 €

- **stabile** Ausführung für **E-Bikes**, ...
- zur Montage an der **Kettenstrebe**, universell passend für Lochabstand **40 und 18 mm**
- mit 2x M6 **Nirosta** Beilagscheiben und Muttern
- **Aluminium**
- **werkzeuglos verstellbar** für **24" - 29"**
- mit **Sicherheitsfuß**
- inkl. Montagematerial
- Montageverpackung

SIDE STAND

- **robust** design for **e-bikes**, ...
- for mounting at the **chain stay**, universally suitable for hole distance **40 and 18 mm**
- with 2x M6 **stainless steel** washers and nuts
- **aluminium**
- **adjustable without tools** for **24" - 29"**
- with **safety foot**
- incl. mounting material
- OEM



ART.-NR. BESCHREIBUNG
UVP

DESCRIPTION



FAHRRADSTÄNDER ›COLUMN-C1‹

- **Aluminium**
- **verstellbar** von 24" - 29"
- extra robuste Ausführung
- besonders **für E-Bikes geeignet**
- mit **stabilem Sicherheitsfuß**
- für Montage in der Mitte (hinter dem Tretlagergehäuse)
- mit Gegenplatte

SIDE STAND ›COLUMN-C1‹

- **aluminium**
- **adjustable** from 24" - 29"
- extra robust design
- especially **suitable for e-bikes**
- with **stable safety foot**
- for assembling behind the B.B. tube (between the chain stays)
- with counter plate



430734 Montageverpackung

OEM

430736 auf M-Wave Eurolochkarte
12,90 €

on M-Wave eurohole card

FAHRRADSTÄNDER

- **Aluminium**
- für Montage in der Mitte (hinter dem Tretlagergehäuse)
- **stufenlos verstellbar**
- mit Sicherheitsfuß
- mit **Edelstahlstreben**
- passend für **24" - 29"**

SIDE STAND

- **aluminium**
- for assembling behind the B.B.-tube (between the chain stays)
- **steplessly adjustable**
- with safety foot
- with **stainless steel rails**
- suitable for **24" - 29"**



430852 Montageverpackung

OEM

430851 auf M-Wave Eurolochkarte
7,90 €

on M-Wave eurohole card



FAHRRADSTÄNDER

- **Aluminium**
- für Montage in der Mitte (hinter dem Tretlagergehäuse)
- **werkzeuglos verstellbar**
- mit Sicherheitsfuß
- mit Gegenplatte

SIDE STAND

- **aluminium**
- for assembling behind the B.B.-tube (between the chain stays)
- **adjustable without tools**
- with safety foot
- with counter plate



passend für **24" - 29"**

suitable for **24" - 29"**

430714 schwarz, auf M-Wave Eurolochkarte

black, on M-Wave eurohole card

430716 silber, Montageverpackung
7,90 €

silver, OEM



passend für **16" - 20"**

suitable for **16" - 20"**

430712 schwarz, auf M-Wave Eurolochkarte
6,90 €

black, on M-Wave eurohole card

430217 FAHRRAD-WANDHALTER ›COLLECTOR‹

44,90 €



- zugelassen auch für **E-Bikes bis 40 kg**
- für Fahrräder, Fahrradträger, Ski, ...
- mit **Helm-, ... -ablage**
- besonders **stabil** und **belastbar**
- 2 Haltebügel mit Kunststoff-**Schutzüberzug**
- **hochklappbar**
- mit Befestigungsschrauben und Dübeln
- mit M-Wave Eurolochkarte

BICYCLE DEPOT WALL HANGER ›COLLECTOR‹

- also approved for **e-bikes up to 40 kg**
- for bikes, bike carriers, ski, ...
- with **helmet, ... depot**
- very **solid** and **loadable**
- two arms with plastic **protection cover**
- **foldable**
- with screws and plugs
- with M-Wave eurohole card



ART.-NR. BESCHREIBUNG
UVP

DESCRIPTION

430215 FAHRRAD-WANDHALTER

29,90 €

**E-BIKES
UP TO
70 KG**

- stabiler Wandhalter
- **zugelassen für bis zu 2 E-Bikes** mit insgesamt bis zu **70 kg**
- Haltebügel mit Kunststoffschutzüberzug
- für Fahrräder, Fahrradträger, Ski, ...
- mit Helm-, ... -Ablage
- **hochklappbar**
- inkl. Montagematerial
- mit M-Wave Banderole

BICYCLE DEPOT WALL HANGER

›COLLECTOR HD‹

- stable wall hanger
- **approved for up to 2 e-bikes** with a total of up to **70 kg**
- hooks with plastic protection cover
- for bikes, bike carriers, ski, ...
- with helmet, ... depot
- **foldable**
- incl. mounting material
- with M-Wave banderole



430288 VERTIKALER UND HORIZONTALER FAHRRADHALTER

68,90 €



2 IN 1

- **2 in 1**
- sehr **einfache Handhabung**
- **platzsparende** und **sichere** Unterbringung
- für **Fahrräder aller Größen 12" - 29"**
- für Reifenbreiten bis **2,50"**
- werkzeuglose Höhenverstellung
- mit **Non-Slip** Füßen
- Montageverpackung

VERTICAL AND HORIZONTAL BICYCLE STAND

›RAIMUND‹

- **2 in 1**
- very **easy handling**
- **space saving** and **safe** storage
- suitable for **all bicycles 12" - 29"**
- for tire widths up to **2.50"**
- toolless height adjustment
- with **non-slip** feet
- OEM

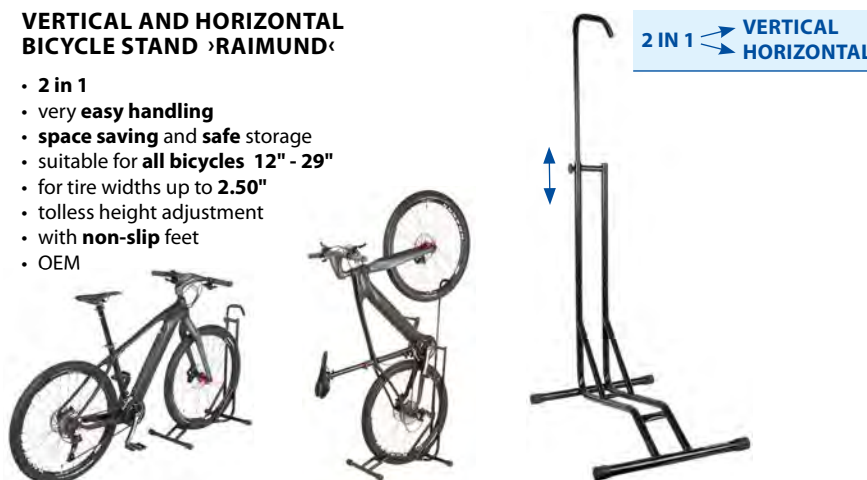

430295 FAHRRADHALTER

46,90 €

**STAIN
LESS**

- **hochwertige Ausführung** aus **Edelstahl**
- für **Fahrräder aller Größen 12" - 29"**
- Reifenbreite bis **2,50"**
- kein Anheben des Rades notwendig, **einfach hinein-/herausrollen**
- aus stabilem Rundrohr
- **Non-Slip** Füße
- mit M-Wave Banderole

BICYCLE STAND

›EASYSTAND PREMIUM‹

- **high-quality** made of **stainless steel**
- for **bicycles of all sizes 12" - 29"**
- max. tire width up to **2.50"**
- no lifting of the bike necessary, **just roll in and out**
- solid round tubes
- **non-slip** feet
- with M-Wave banderole



430298 VERBINDUNGSADAPTER

6,90 €

Machen Sie Einzelständer zum **variablen Mehrfachsystem!**

- **hochwertige Ausführung** aus **Edelstahl**
- universell passend
- auf M-Wave Eurolochkarte

CONNECTOR

Make basic stand to a **variable multiple system!**

- **high-quality** made of **stainless steel**
- universally suitable
- on M-Wave eurohole card



430287 AUFBEWAHRUNGS- UND MONTAGESTÄNDER

27,90 €

›EASYSTAND HOOK‹

- **2 Haken** mit **Gummischutzüberzug**
- für **Fahrräder aller Größen 12" - 29"**
- aus stabilem Rundrohr
- mit **Schaumstoff**breitenadapter
- für Reifenbreiten bis **2,50"**
- mit **Non-Slip** Füßen
- im M-Wave Einzelkarton

STORAGE AND MOUNTING STAND

›EASYSTAND HOOK‹

- **2 hooks** with **rubber protection cover**
- for **bicycle of all sizes 12" - 29"**
- solid round tubes
- with **foam** width adapter
- for tire widths up to **2.50"**
- with **non-slip** feet
- in M-Wave box



ART.-NR. BESCHREIBUNG
UVP

DESCRIPTION

12"
-
29"

FAHRRADHALTER ›EASYSTAND‹

- für **Fahrräder aller Größen 12" - 29"**
- Reifenbreite bis **2,50"**
- kein Anheben des Rades notwendig, **einfach hinein-/herausrollen**
- mit **Breitenadapter**
- aus stabilem Rundrohr
- mit **Schaumstoffschutz**
- **Non-Slip** Füße

BICYCLE STAND ›EASYSTAND‹

- for **bicycles of all sizes 12" - 29"**
- max. tire width up to **2.50"**
- no lifting of the bike necessary, **just roll in and out**
- with **width adapter**
- solid round tubes
- with **foam cover**
- **non-slip** feet

430285 schwarz, im M-Wave Einzelkarton

black, in M-Wave box

Montageverpackung

OEM

430280 schwarz

black

430282 silber

silver

27,90 €

430290 • für Fahrräder von **16" - 20"** geeignet
• schwarz, Montageverpackung

26,90 €

• suitable for bicycles from **16" - 20"**
• black, OEM

16"
-
20"



430291 FAHRRADHALTER ›EASYSTAND PLUS‹

32,90 €

PLUS
FAT
✓

- **Reifenbreite von 2,50" - 3,25"**
- für **Fahrräder aller Größen 12" - 29"**
- kein Anheben des Rades notwendig, **einfach hinein-/herausrollen**
- aus stabilem Rundrohr
- mit **Schaumstoffschutz**
- **Non-Slip** Füße
- schwarz
- Montageverpackung

BICYCLE STAND ›EASYSTAND PLUS‹

- **tire width 2.50" - 3.25"**
- for **bicycles of all sizes 12" - 29"**
- no lifting of the bike necessary, **just roll in and out**
- solid round tubes
- with **foam cover**
- **non-slip** feet
- black
- OEM



430249 FAHRRADHALTER

32,90 €

MTB
26"-29"

ROAD
700x
20-45C

KIDS

- **platzsparend da klappbar**
- für **20" - 29"** geeignet
- kein Anheben des Rades notwendig, einfach **hinein-/herausrollen**
- sicherer Halt des Rades durch **3-Punkt-Halterung**
- für verschiedene Reifenbreiten **optimiert**

BICYCLE STAND

- **space saving** because **foldable**
- suitable for **20" - 29"**
- no lifting of the bike necessary, **just roll in and out**
- secure stand of the bicycle through **3-point fitting**
- **optimized** for different tire widths



439903 FAHRRADHALTER ›CHOPSTAND APART‹

20,90 €



- **werkzeug- und stufenlos höhenverstellbar um 150 mm**
- **platzsparend zerlegbar**
- mit **Kratzschutz**
- für **12" - 29"** geeignet
- für Verwendung an der Vorder- oder Hinterradachse
- für fast alle Räder mit **Scheibenbremsen geeignet**
- in M-Wave Eurolochbox

BICYCLE STAND ›CHOPSTAND APART‹

- **150 mm stepless height adjustment without tools**
- **space savingly demountable**
- with **scratch protection**
- suitable for **12" - 29"**
- for using at the front or rear axle
- suitable for almost every bike with **disc brakes**
- in M-Wave eurohole box



430252 FAHRRADHALTER

22,90 €

- mit **Kratzschutz**
- für **12" - 29"** geeignet
- für Verwendung an der **Vorder- oder Hinterradachse**
- für fast alle Räder mit **Scheibenbremsen geeignet**

BICYCLE STAND

- with **scratch protection**
- suitable for **12" - 29"**
- for using at the **front or rear** axle
- usable for almost every bike with **disc brakes**

ART.-NR. BESCHREIBUNG
UVP

DESCRIPTION

430098

FAHRRADLIFT
›BIKE LIFT STRONG‹

41,90 €/set

E-BIKES
UP TO
57 KG

- mit **Gummi überzogenen** Befestigungshaken zum Schutz vor Verkratzen des Fahrrads
- **stabiles Rundseil** Ø 6,5 mm
- bis zu 4 m Höhe
- geeignet bis **57 kg, daher für E-Bikes nutzbar**
- im M-Wave Einzelkarton

BICYCLE LIFT

›BIKE LIFT STRONG‹

- hooks with **plastic covers** for scratch protection
- **stable round rope** Ø 6.5 mm
- up to 4 m ceiling height
- usable up to **57 kg, so suitable for E-bikes**
- in M-Wave box



STÜTZRÄDER

- nach **ISO 8098**
- für Kinder-Fahrräder
- passend für **12" - 20"**
- mit Zusatzstrebe als **Drehschutz**

STABILIZER

- according to **ISO 8098**
- for children bikes
- suitable for **12" - 20"**
- with **anti-turn** bracket

according to ISO 8098



439991

paarweise im Polybeutel

one pair in PE bag

9,90 € / pair

439992

in M-Wave Blisterverpackung

in M-Wave blister packaging

13,90 / pair

431570

WEIDENKORB
›BA-FW CLIP STEM‹

69,90 €

CLIP-ON

- aus echtem **Weidengeflecht**
- handgemacht
- Montage vorne mit **Clip-on**-Halter für Vorbau oder Steuersatzrohr
- ca. 38 x 28 x 27 cm
- mit M-Wave Karte

WICKER BASKET

›BA-FW CLIP STEM‹

- made of genuine **wicker network**
- handmade
- mounting at the front with **clip-on** bracket for stem or head set tube
- approx. 38 x 28 x 27cm
- with M-Wave card



431571

ERSATZ-/ZWEIT-CLIP-ON-HALTER

11,90 €

universell passend für Art. 431570 und viele andere Körbe

REPLACEMENT/SECOND CLIP-ON BRACKET

universally suitable for art. 431570 and many other baskets



431572

WEIDENKORB
›BA-FW CLIP BAR‹

57,90 €

CLIP-ON

- aus echtem **Weidengeflecht**
- handgemacht
- inkl. **Clip-on**-Halter für Lenkermontage (Ø 22,2 - 31,8 mm)
- ca. 38 x 28 x 26 cm
- Ersatz-/ Zweit-Clip-on-Halter: Art. 122709
- mit M-Wave Karte

WICKER BASKET

›BA-FW CLIP BAR‹

- made of genuine **wicker network**
- handmade
- incl. **clip-on** bracket for mounting at handlebar (Ø 22.2 - 31.8 mm)
- approx. 38 x 28 x 26 cm
- replacement/ second clip-on bracket: art. 122709
- with M-Wave card



ART.-NR. BESCHREIBUNG
UVP

DESCRIPTION

431650 WEIDENKORB ›UNIVERSAL‹

- 65,90 €
- aus echtem **Weidengeflecht**
- handgemacht
- mit Deckel
- z. B. für Vorderrad-Gepäckträger Art. 440455
- ca. 40 x 33 x 25,5 cm
- mit M-Wave Karte

WICKER BASKET ›UNIVERSAL‹

- made of genuine **wicker network**
- handmade
- with lid
- e. g. for front wheel carrier art. 440455
- approx. 40 x 33 x 25.5 cm
- with M-Wave card



431605 WEIDENKORB ›CARRIER TOP‹

- 91,90 €
- aus echtem **Weidengeflecht**
- handgemacht
- mit "Deckel" aus Stahldraht
- **werkzeuglose Befestigung** am Gepäckträger
- auch für Haustiere geeignet
- ca. 43,5 x 31 x 22/16,5 cm
- mit M-Wave Karte



WICKER BASKET ›CARRIER TOP‹

- made of genuine **wicker network**
- handmade
- with steel wire „lid“
- **toolless mounting** on carrier
- also for pets
- approx. 43.5 x 31 x 22/16.5 cm
- with M-Wave card



431604 WEIDENKORB ›BA PET‹

- 94,90 €
- aus echtem **Weidengeflecht**
- handgemacht
- mit "Deckel" aus Stahldraht
- Befestigung mit **Clip-on-Halter am Sitzrohr oder Vorbau**
- auch für Haustiere geeignet
- ca. 43 x 29,5 x 22/14 cm
- mit M-Wave Karte



WICKER BASKET ›BA PET‹

- made of genuine **wicker network**
- handmade
- with steel wire „lid“
- mounting with **clip-on bracket on seat tube or stem**
- also for pets
- approx. 43 x 29.5 x 22/14 cm
- with M-Wave card



431515 DRAHTKORB ›BA-F CLIP BAR‹

- 21,90 €
- besonders **stabile** und **hochwertige Ausführung**
- aus feinmaschigem Stahlgeflecht
- **verstärkte** Haupt- und Nebenstreben
- **kunststoffummantelter, ergonomischer Tragegriff**
- ca. 35 x 25 x 25/22 cm
- mit **Clip-on-Halter** (Art. 122709) für Montage am Lenker (**Ø 22,2 mm - Ø 31,8 mm**) und Abstützung am Vorbau
- **Neigungswinkel einstellbar**
- mit M-Wave Logoplatte
- mit M-Wave Karte



WIRE BASKET ›BA-F CLIP BAR‹

- very **firm** and **high quality design**
- fine meshed steel net
- **reinforced** main and auxiliary bars
- **plastic covered, ergonomic handle**
- approx. 35 x 25 x 25/22 cm
- with **clip-on bracket** (art. 122709) for assembling on handlebar (**Ø 22.2 mm - Ø 31.8 mm**) and brace support on the stem
- **adjustable angle**
- with M-Wave logo plate
- with M-Wave card



CLIP-ON DRAHTKORB

- besonders **stabile** und **hochwertige Ausführung**
- aus feinmaschigem Stahlgeflecht
- **verstärkte** Haupt- und Nebenstreben
- **kunststoffummantelter, ergonomischer Tragegriff**
- mit stabilem Vorbau-**Clip-on-Halter** für 1" und 1½" Vorbauten
- mit M-Wave Logoplatte
- mit M-Wave Karte



WIRE BASKET

- very **firm** and **high quality design**
- fine meshed steel net
- **reinforced** main and auxiliary bars
- **plastic covered, ergonomic handle**
- with firm stem **clip-on bracket** for 1" and 1½" stems
- with M-Wave logo plate
- with M-Wave card



431525 ›BA-F CLIP STEM‹

- 19,90 € ca. 33,5 x 25,5 x 25,5/22 cm (B x L x H)

›BA-F CLIP STEM‹

- approx. 33.5 x 25.5 x 25.5/22 cm (W x L x H)

431526 ›BA-F CLIP STEM LONG‹

- 18,90 € ca. 21,5 x 31 x 25/23 cm (B x L x H)

›BA-F CLIP STEM LONG‹

- approx. 21.5 x 31 x 25/23 cm (W x L x H)

ART.-NR. BESCHREIBUNG
UVP

DESCRIPTION

431502 DRAHTKORB ›BA-F HANG‹

12,90 €

- besonders **stabile** und **hochwertige Ausführung**
- **universeller, biegbarer Befestigungsbügel**
- für Lenker
- ca. 34,5 x 25,5 x 26/23 cm
- **kunststoffummantelter, ergonomischer Tragegriff**
- mit M-Wave Logoplatte

WIRE BASKET ›BA-F HANG‹

- very **firm** and **high quality design**
- **universal, twistable mounting bracket**
- for handlebar
- approx. 34.5 x 25.5 x 26/23 cm
- **plastic covered ergonomic handle**
- with M-Wave Logo plate



122479 LENKERBOX ›AMSTERDAM BOX FRONT‹

27,90 €

- **abschließbar**, inkl. 2 Schlüssel
- zur Montage am Steuersatz (1") und der Vorderradnabe (Adapter für 1 1/8" Steuersatz erhältlich = Art. 431799)
- aus Kunststoff
- **staub- und spritzwassergeschützt**
- passend für 26" - 29" Reifen
- Bügel zum leichten Öffnen und zum Schutz des Schließzylinders
- Volumen ca. 17 Liter
- ca. 23 x 26 x 33 cm

FRONT TOP CASE ›AMSTERDAM BOX FRONT‹

- **lockable**, incl. 2 keys
- for mounting at the head set (1") and the front wheel hub (adapter for 1 1/8" head set available = art. 431799)
- plastic
- **dust and water protected**
- suitable for 26" - 29" tires
- bracket for easy opening and for protection of the lock cylinder
- volume approx. 17 litres
- approx. 23 x 26 x 33 cm



431542 DRAHTKORB ›BA-RM CLAMP L‹

26,90 €



- besonders **stabile** und **hochwertige Ausführung**
- **verstärkte** Haupt- und Nebenstreben
- **2 mit Schaumstoff ummantelte Tragegriffe**
- ca. 45,5 x 29,5 x 21/13 cm (B x L x H)
- werkzeuglose Montage mit **Clip-on Klemmbefestigung**
- mit M-Wave Logoplatte
- mit M-Wave Karte

WIRE BASKET ›BA-RM CLAMP L‹

- very **firm** and **high quality design**
- **reinforced** main and auxiliary bars
- **2 foam covered handles**
- approx. 45.5 x 29.5 x 21/13 cm (W x L x H)
- toolless mounting with **clip-on clamp fixation**
- with M-Wave logo plate
- with M-Wave card

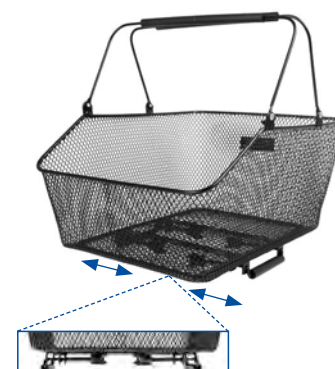

431593 DRAHTKORB ›BA-RM CLAMP W‹

21,90 €



- besonders **stabile** und **hochwertige Ausführung**
- **verstärkte** Haupt- und Nebenstreben
- **kunststoffummantelter, ergonomischer Tragegriff**
- ca. 41 x 31 x 17 cm
- werkzeuglose Montage mit **Clip-on Klemmbefestigung**
- mit M-Wave Logoplatte
- mit M-Wave Karte

WIRE BASKET ›BA-RM CLAMP W‹

- very **firm** and **high quality design**
- **reinforced** main and auxiliary bars
- **plastic covered ergonomic handle**
- approx. 41 x 31 x 17 cm
- toolless mounting with **clip-on clamp fixation**
- with M-Wave logo plate
- with M-Wave card



431592 DRAHTKORB ›BA-RM XL‹

19,90 €

- besonders **stabile** und **hochwertige Ausführung**
- **verstärkte** Haupt- und Nebenstreben
- **kunststoffummantelter, ergonomischer Tragegriff**
- ca. 51 x 30 x 20 cm
- besonders **breit** für Schultaschen und Aktenkoffer
- mit M-Wave Logoplatte

WIRE BASKET ›BA-RM XL‹

- very **firm** and **high quality design**
- **reinforced** main and auxiliary bars
- **plastic covered ergonomic handle**
- approx. 51 x 30 x 20 cm
- very **wide** for school bags and briefcases
- with M-Wave logo plate

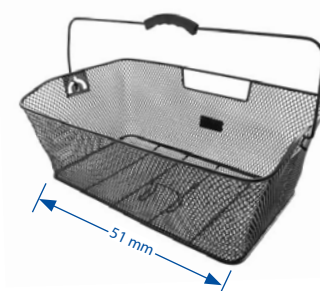

ART.-NR. BESCHREIBUNG
UVP

DESCRIPTION

XXL

DRAHTKORB

- **stabile** und **hochwertige Ausführung**
- **verstärkte** Haupt- und Nebenstreben
- mit M-Wave Logoplatte
- mit M-Wave Karte

WIRE BASKET

- **firm** and **high quality design**
- **reinforced** main and auxiliary bars
- with M-Wave logo plate
- with M-Wave card

431594

›BA-RM XXL‹

18,90 €

- zur **festen Montage quer** über dem Gepäckträger
- XL: ca. 30,5 x 48,5 x 23/15 cm (L x B x H)

›BA-RM XXL‹

- for **fixed installation across** on the carrier
- XL: approx. 30.5 x 48.5 x 23/15 cm (L x W x H)

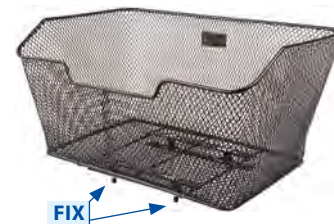

FIX

431550

›BA-RM Along‹

18,90 €

- zur **festen Montage längs** über dem Gepäckträger
- ca. 45 x 30 x 20/13 cm (L x B x H)
- besonders **schmal** und daher nicht seitlich überstehend

›BA-RM Along‹

- for **fixed installation lengthwise** on the carrier
- approx. 45 x 30 x 20/13 cm (L x W x H)
- extra **narrow**, therefore non-protruding from both sides

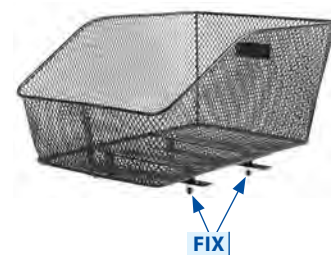

FIX

431630

DRAHTKORB

17,90 €

›BA-R HANG CARRIER‹

- besonders **stabile** und **hochwertige Ausführung**
- **universeller, biegbarer Befestigungsbügel und Klettverschluss**
- zur **seitlichen Montage am Gepäckträger**
- 37 x 19 x 25 cm
- **kunststoffummantelter, ergonomischer Tragegriff**
- mit M-Wave Logoplatte
- mit M-Wave Karte

WIRE BASKET

›BA-R HANG CARRIER‹

- very **firm** and **high quality design**
- **universal, twistable mounting bracket and hook and loop fastener**
- for **mounting sideways on the carrier**
- 37 x 19 x 25 cm
- **plastic covered, ergonomic handle**
- with M-Wave logo plate
- with M-Wave card



431591

DRAHTKÖRBE ›BA-RM‹

12,90 €

- besonders **stabile** und **hochwertige Ausführung**
- **schwarz**
- **verstärkte** Haupt- und Nebenstreben
- **kunststoffummantelter, ergonomischer Tragegriff**
- ca. 41 x 31 x 16 cm
- besonders engmaschig
- mit M-Wave Logoplatte

WIRE BASKETS ›BA-RM‹

- very **firm** and **high quality design**
- **black**
- **reinforced** main and auxiliary bars
- **plastic covered, ergonomic handle**
- approx. 41 x 31 x 16 cm
- very small meshed
- with M-Wave logo plate



122352

KORB + TASCHENÜBERZUG
›MAASTRICHT PROTECT‹

10,90 €

- **universeller** Regenschutz für **Körbe**, Rucksäcke bis ca. 25 Liter, Vorderradtaschen, Gepäcktaschen, ...
- mit **2 Haltegurten** auf der Rückseite
- neongelb
- **3M Scotchlite** **Reflexstreifen** auf drei Seiten
- mit aufgesetzter Netztasche
- auf M-Wave Eurolochkarte

BASKET + BAG COVER
›MAASTRICHT PROTECT‹

- **universal** rain protection for **baskets**, backpack up to approx. 25 litres, front bags, rear bags, ...
- with **2 fixation straps** on back
- **neon yellow**
- **3M Scotchlite** **reflective stripes** on three sides
- with fitted net pocket
- on M-Wave eurohole card



2 X FIX

Baskets

ART.-NR. UVP **BESCHREIBUNG**

DESCRIPTION

780168 GEPÄCKGURT

8,90 € / pair

- sehr **stabile Stahlhaken** mit **Kunststoffummantelung**
- flacher Gummispanngurt
- **vierfach**
- 600 x 13 mm
- ein **Paar** auf **M-Wave Eurolochkarte**

BUNGEE CORD

- very **strong steel hooks** with **plastic cover**
- flat bungee cord
- **quadruple**
- 600 x 13 mm
- one **pair** on **M-Wave eurohole card**



440174 ALUMINIUM-GEPÄCKTRÄGER

27,90 €

- ›ONE - 4 - ALL‹
- **verstellbar** für 20" - 29"
 - besonders geeignet für **Rahmen mit schwierigen Befestigungsmöglichkeiten** (z. B. wegen Scheibenbremsaufnahme), da **Seitenstreben** in Neigung und Länge **einzel**n **verstellbar** sind
 - mit Reflektor-/Rücklichthalter und Federklappe
 - mit **Universalbefestigungsset**
 - mit **Nirosta**-Befestigungsmaterial
 - Auflagefläche: 39 x 14 cm (L x B)
 - mit M-Wave Eurolochkarte

ALUMINIUM CARRIER

- ›ONE - 4 - ALL‹
- **adjustable** for 20" - 29"
 - specially suitable for **frames with difficult mounting facilities** (e. g. due to disc brake mounts), because the **side bars** are **individually adjustable** in length and tilt
 - with reflector/rear light bracket and spring flap
 - with **universal fitting set**
 - with **stainless steel** mounting material
 - loading surface: 39 x 14 cm (L x W)
 - with M-Wave eurohole card

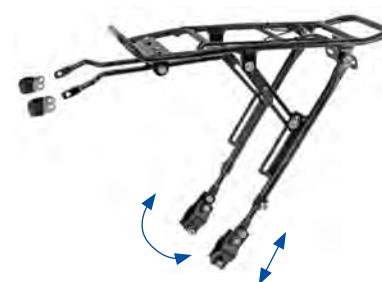

ALUMINIUM-GEPÄCKTRÄGER

›SCREW - ON II A‹

- **verstellbar** für 24"/26"/28"
- aus **4-kant Aluminium-Rohr**
- mit Reflektor-/Rücklichthalter und Federklappe
- mit **Pumpenspitzen**
- mit **Universalbefestigungsset**
- kleines Verpackungs- und Präsentationsmaß (**Seitenteile abnehmbar**)
- mit **Edelstahl-Schrauben**
- Auflagefläche: 37,5 x 13 cm (L x B)
- in M-Wave **Blisterverpackung**

ALUMINIUM CARRIER

- ›SCREW - ON II A‹
- **adjustable** for 24"/26"/28"
 - **square type aluminium tube**
 - with reflector/rear light bracket and spring flap
 - with **pump pegs**
 - with **universal fitting set**
 - small packaging and presentation size (**side parts detachable**)
 - with **stainless steel screws**
 - loading surface: 37.5 x 13 cm (L x W)
 - in M-Wave **blister packaging**

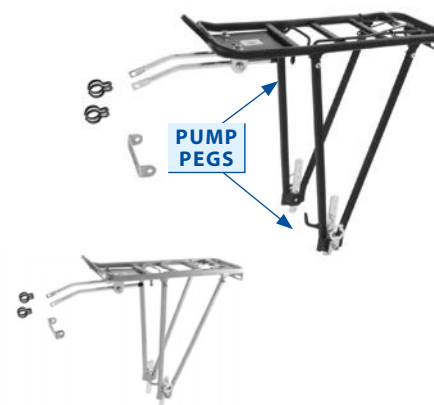

440158 schwarz

black

440157 silber

silver

27,90 €

440454 MINI-GEPÄCKTRÄGER

16,90 €

2 IN 1

FRONT + REAR

- ›MINI F + R‹
- aus **Aluminium**
 - universell einsetzbar für **vor**ne oder **hint**en
 - nur **254 g**
 - Befestigung an den **Bremssockeln** und Gabelbrücke (vorne) oder Sitzstrebenbrücke/Pletscherplatte (hinten)
 - für 24" - 28"
 - mit **Nirostaschrauben**
 - mit Reflektorhalter
 - inkl. Befestigungsmaterial
 - Auflagefläche: 22 x 14 cm (L x B)

MINI PANNIER RACK

- ›MINI F + R‹
- made of **aluminium**
 - universal fitting for **front** or **rear**
 - only **254 g**
 - for mounting at the **brake pivots** and fork crown (front) or seat stay bridge/Pletscher plate (rear)
 - for 24" - 28"
 - with **stainless steel** screws
 - with reflector bracket
 - incl. mounting material
 - loading surface: 22 x 14 cm (L x W)



449902 GEPÄCKTRÄGERPLATTE

19,90 €

- ›RACKY BASEPLATE‹
- **Aluminium**
 - Trägerplatte zur **Vergrößerung der Auflagefläche des Gepäckträgers**
 - inkl. **3 Universalbefestigungsstreben**
 - für alle gängigen Gepäckträger
 - 400 x 400 mm
 - mit M-Wave Banderole

CARRIER PLATE

- ›RACKY BASEPLATE‹
- **aluminium**
 - carrier plate for **enlarging the contact area of the carrier**
 - incl. **3 universal** mounting struts
 - for all common carriers
 - 400 x 400 mm
 - with M-Wave banderole



ART.-NR. UVP **BESCHREIBUNG**

DESCRIPTION

440400 UNIVERSELLER TASCHENHALTER ›RACKY BAG‹

21,90 €

- Aluminium
- Anbringung an **allen gängigen Gepäckträgern** möglich
- ermöglicht unkomplizierten **Transport von Rucksäcken, Einkaufstaschen, ...**
- mit Spannungsgurt zur Fixierung
- nur 223 g
- max. Zuladung 5 kg
- mit M-Wave Banderole

UNIVERSAL BAG HOLDER ›RACKY BAG‹

- aluminium
- can be attached to **all common luggage racks**
- enables uncomplicated **transport of backpacks, shopping bags, ...**
- with tension belt for fixation
- only 223 g
- max. load 5 kg
- with M-Wave banderole



440490 SCHNELLSPANNER SET

9,90 €

- zur **Montage von Gepäckträgern** an Rädern:
 - **ohne Befestigungsösen** (z. B. Rennräder)
 - mit **hinderlichen Sitzrohr- oder Kettenstreben, Ausfallenden, ...**
- passend auch für **Fahrradanhänger** Art. 640050, ...
- mit 8 je 5 mm breiten **Adapter-scheiben**
- **Aluminium**hebel
- Länge 210 mm
- für Nabeneinbaumaß: ≥ 130 mm
- **Einklembreite: 137 - 177 mm** (in 5 mm Schritten)
- auf M-Wave Eurolochkarte

QUICK RELEASE SET

- **for mounting of carriers** to bicycles:
 - **without mounting eyelets** (e. g. road bikes)
 - with **obstructive seat stays, chain stays, derailleur hangers, ...**
- also suitable for **bicycle trailer** art. 640050, ...
- with 8 **adapters**, each 5 mm wide
- **aluminium** lever
- length 210 mm
- OLD: ≥ 130 mm
- **clamp width: 137 - 177 mm** (in 5 mm steps)
- on M-Wave eurohole card

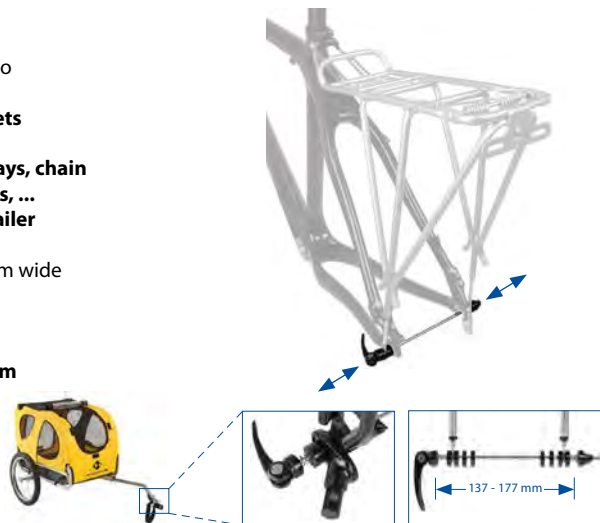

STECKACHSE FÜR ANHÄNGER-KUPPLUNG ›STALWART AXLE‹

- durch Innengewinde auch zur **Montage von Gepäckträgern an Steckachsen** geeignet
- zur **werkzeuglosen Montage von Standard Fahrrad-Anhänger-Kupplungen** an **12 mm Steckachs-naben**
- **2 in 1:** durch 6 mm Distanzscheibe passend für 12 mm Steckachs-naben mit **142 mm** Einbaumaß und für **Boost-Naben** mit **148 mm** Einbaumaß
- Aluminium
- mit Schnellspanner
- auch **ohne Schnellspanner als saubere Lösung** für Steckachsen nutzbar
- mit zusätzlichem Innengewinde für M6-Schrauben, für z. B. Gepäckträgermontage
- mit zusätzlichen Unterlegscheiben zur **Einstellung der Schnellspannhebel-Position**
- auf M-Wave Eurolochkarte

THRU AXLE FOR TRAILER MOUNT ›STALWART AXLE‹

- due to the internal thread also suitable for **mounting carriers to thru axles**
- for **toolless mounting of standard bicycle trailer adapters** at **12 mm thru axle hubs**
- **2 in 1:** by 6 mm spacer suitable for 12 mm thru axle hubs with OLD **142 mm** and for **boost hubs** with OLD **148 mm**
- aluminium
- with QR
- also usable **without QR as clean solution** for quick-release axle
- with additional internal thread for M6 screws for e. g. carrier assembly
- with additional spacers for **adjusting the QR lever position**
- on M-Wave eurohole card

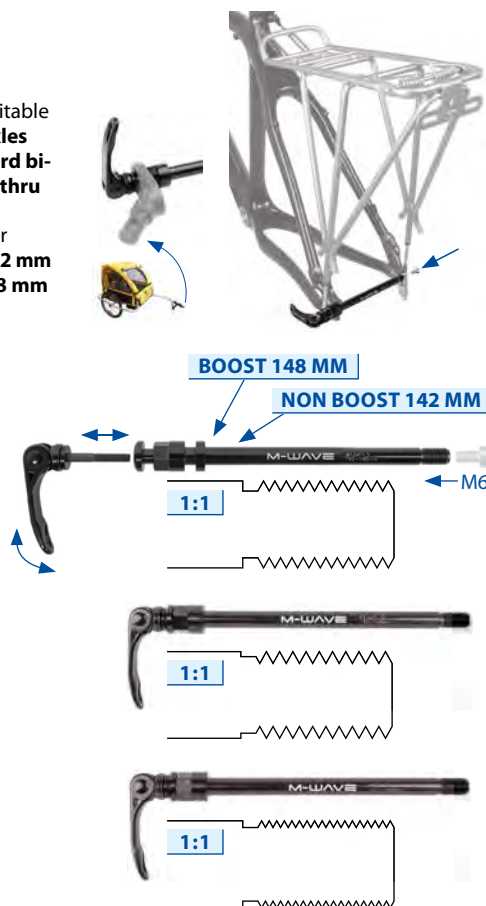

640140 • Shimano Type
(kein original Shimano Ersatzteil)
Gewindesteigung: P1.5 x T20

• **Shimano Type**
(no original Shimano spare part)
thread pitch: P1.5 x T20

640141 • Maxle Type
(kein original Maxle Ersatzteil)
Gewindesteigung: P1.75 x T20

• **Maxle Type**
(no original Maxle spare part)
thread pitch: P1.75 x T20

640142 • Syntace Type
(kein original Syntace Ersatzteil)
Gewindesteigung: P1.0 x T20
mit konischer Verbindungsscheibe

• **Syntace Type**
(no original Syntace spare part)
thread pitch: P1.0 x T20
with conical spacer

ART.-NR. BESCHREIBUNG
UVP

DESCRIPTION

470415 ELEKTRISCHE PUMPE
›ELUMATIK USB 2 / AP-117‹

77,90 €



- **kleines, handliches Format**
- **Druck voreinstellbar**
- pumpt Schläuche, Bälle, Luftmatratzen,... **selbstständig** bis zum **voreingestellten Druck** auf und schaltet dann automatisch ab
- **Lithium-Ionen-Akku**
- mit Micro USB Ladebuchse (Ladekabel enthalten)
- **beleuchtetes LCD-Display**
- bis max. 150 psi / 10,3 bar
- **Universal-Doppelpumpenkopf** für FV / AV / DV
- inkl. **Ballnadel** und **Luftmatratzen-adapter**
- mit integriertem **LED-Licht**
- mit wasserdichter Tasche, welche mit 3 Klettverschlüssen werkzeuglos am Oberrohr angebracht werden kann
- in M-Wave Einzelkarton

ELECTRIC PUMP
›ELUMATIK USB 2 / AP-117‹

- **small and compact**
- **pressure presetting**
- pumps up tubes, balls, air beds,... **autonomously** up to the **default pressure** and turns off automatically afterwards
- **Lithium Ion rechargeable battery**
- with **micro USB charging port** (charging cable included)
- **illuminated LCD display**
- up to max. 150 psi / 10.3 bar
- **universal double pump head** for FV / AV / DV
- incl. **ball needle** and **adapter for air beds**
- with integrated **LED light**
- with waterproof bag, which can be toollessly mounted to the top tube by 3 hook and loop fasteners
- in M-Wave box



470281 MINI-PUMPE ›MINIATAIR‹

17,90 €



- **CNC-gefrästes Aluminium**
- bis 6,2 bar / 90 psi
- für FV, AV und DV
- nur **68 g**
- nur **120 mm**
- mit Halter und Gummibandbefestigung
- auf M-Wave Eurolochkarte

MINI PUMP ›MINIATAIR‹

- **CNC machined aluminium**
- up to 6.2 bar / 90 psi
- for FV, AV and DV
- only **68 g**
- only **120 mm**
- with bracket and rubber strap
- on M-Wave eurohole card



470337 DOPPELKOPFPUMPE
›DOUBLE SHOT B‹

11,90 €

- **Aluminium**
- bis 8,5 bar / 120 psi
- mit **Universal-Doppelpumpenkopf** für AV, FV und DV
- mit **Schnellverschluss**
- mit Staubschutzkappe
- mit **Manometer** und **“Double Shot“-Funktion**
- mit **rutschfestem Softgriff**
- mit Halter
- auf M-Wave Eurolochkarte

DOUBLE HEAD PUMP
›DOUBLE SHOT B‹

- **aluminium**
- up to 8.5 bar / 120 psi
- with **universal double pump head** for AV, FV and DV
- with **quick fastening lever**
- with dust protection cap
- with **manometer** and **“Double Shot” function**
- with **non-slip soft handle**
- with bracket
- on M-Wave eurohole card

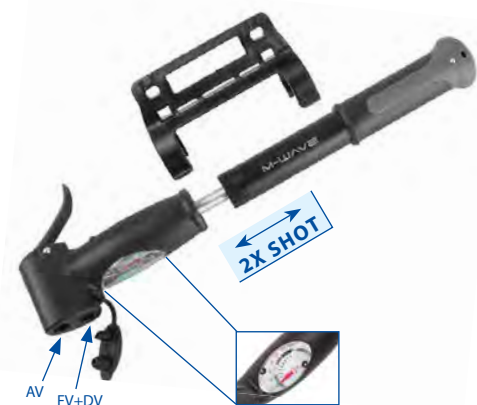

470280 MINI-PUMPE ›FLEXI TUBE‹

8,90 €

- **Aluminiumpumpe**
- für FV, AV und DV
- nur **89 g**
- mit **herausnehmbarem, 150 mm langen Schlauch**
- mit Staubschutzkappe
- mit Halter und Sicherungsband
- auf M-Wave Eurolochkarte

MINI PUMP ›FLEXI TUBE‹

- **aluminium pump**
- for FV, AV and DV
- only **89 g**
- with **removable, 150 mm long tube**
- with dust protection cap
- with bracket and safety strap
- on M-Wave eurohole card



ART.-NR. BESCHREIBUNG
UVP

DESCRIPTION

470335 STANDPUMPE ›AIR BULLET‹

145,00 €

TUBE LESS

- Aluminium
- **sekundenschnelle Befüllung** oder normal pumpen
- insbesondere für die Montage **schlauchloser Reifen** geeignet
- bis **18 bar / 260 psi**
- extra **langer Pumpenschlauch**
- mit **Universal-Pumpenkopf** für **FV, AV** und **DV**
- mit **Lufttank**
- Manometer an der Oberseite für leichtes Ablesen
- stabiler Fuß mit Anti-Rutsch-Einlage
- mit M-Wave Karte

FLOOR PUMP ›AIR BULLET‹

- aluminium
- **inflation within seconds** or normal pumping
- in particular suitable for **tubeless tires** mounting
- up to **18 bar / 260 psi**
- extra **long pump tube**
- **universal pump head** for **FV, AV** and **DV**
- with **air tank**
- top-mounted manometer for easy reading
- stable base with non-slip pad
- with M-Wave tag



470531 STANDPUMPE ›AIR FLOW‹

39,90 €

- poliertes **Aluminium**
- bis **10 bar / 145 psi**
- mit **Universal-Pumpenkopf** für **FV, AV** und **DV**
- extra **langer Pumpenschlauch**
- mit Schnellverschlusshebel
- großes, flaches, gut lesbares Manometer
- Ballnadel und Luftmatratzenadapter
- mit M-Wave Karte

FLOOR PUMP ›AIR FLOW‹

- polished **aluminium**
- up to **10 bar / 145 psi**
- **universal pump head** for **FV, AV** and **DV**
- extra **long pump tube**
- with quick fastening lever
- big, flat, well readable manometer
- ball needle and adapter for air beds
- with M-Wave tag



470375 STANDPUMPE ›AIR JET‹

28,90 €

XL MANO METER

- bis **11 bar / 160 psi**
- mit **Universal-Pumpenkopf** für **FV, AV** und **DV**
- **extra großes, gut lesbares Manometer**
- **Non-Slip** Zweikomponentengriff
- stabiler Fuß
- mit M-Wave Karte

FLOOR PUMP ›AIR JET‹

- up to **11 bar / 160 psi**
- **universal pump head** for **FV, AV** and **DV**
- **extra big, well readable manometer**
- **non-slip** 2-component handle
- stable base
- with M-Wave tag



470186 CO2-PATRONE

4,90 € / set

- **16 g**
- mit 3/8" Gewinde
- 2 Stück in M-Wave Eurolochbox

CO2 CARTRIDGE

- with 3/8" thread
- **16 g**
- 2 pieces in M-Wave eurohole box



ALUMINIUM-VENTILVERLÄNGERUNG

- für FV
- zur Verwendung in Hochprofilfelgen
- paarweise auf M-Wave Eurolochkarte

ALUMINIUM VALVE EXTENSION

- for FV
- for using with high profil rims
- one pair on M-Wave eurohole card

519947

9,90 €

- verlängert das Ventil um **50 mm**
- **gedichtet**
- für FV mit heraus-schraubbarem Ventileinsatz
- mit Werkzeug zum Heraus-schrauben des Ventileinsatzes
- schwarz

- prolongs the valve by **50 mm**
- **sealed**
- for FV with removable valve insert
- with tool to unscrew the valve insert
- black



519948

6,90 €

- verlängert das Ventil um **40 mm**
- silber

- prolongs the valve by **40 mm**
- silver



TUBELESS: GUT - GÜNSTIG - 3 in 1!

Rennfahrer verwenden oft **normale Faltreifen** und unser Tubelesskit, um jedes Gramm **Gewicht zu sparen**. Nutzen auch Sie das schlauchlose System von **M-Wave** mit Ihren **bisherigen Reifen, SCT- oder UST-Reifen**. Mit dem Tubelesskit entfällt das Wechseln und Flickern von Schläuchen und Sie **sparen Gewicht**.

- 1) Jede **herkömmliche Felge** kann **kostengünstig** auf ein **Schlauchlos-system** umgerüstet werden.
- 2) M-Wave Tubelesskit ist auch für die **Verwendung mit Kenda SCT Reif**en geeignet. So können Sie ein Tubeless-System fahren, ohne dabei das höhere Gewicht und Kosten von UST-Reifen in Kauf nehmen zu müssen.
- 3) Mit dem M-Wave Tubelesskit kann mit **nur 2 bar Luftdruck** gefahren werden, ohne dass der Reifen durch einen Felgendurchschlag (Snakebite) gefährdet ist. Dadurch erreicht man:
 - a) eine **deutlich bessere Dämpfung**
 - b) **mehr Traktion** in jedem Gelände
 - c) bergauf kann man länger im Sattel bleiben
 - d) bergab **besseres Bremsverhalten**
 - e) mehr **Grip in Kurven**
 - f) dass mit **schmaleren** und damit **leichteren Reifen** gefahren werden kann.
- 4) Durch den Einsatz dieses Systems ist der **Rollwiderstand** gegenüber einem Schlauchsystem bis zu **15 % niedriger**.
- 5) Schlauchlosreifen können nicht immer 100 % luftdicht hergestellt werden. Mit dem M-Wave Tubelesskit wird der **Reifen dicht und ist für über 6 Monate selbstflickend** (bis zu **6 mm** Löcher).

TUBELESS: GOOD QUALITY - FAIR PRICE - 3 in 1!

Racers often use **standard folding tires** and our Tublesskit in order to **save every gram of weight**. You can also use our Tubless System from **M-Wave** with your **existing tires, SCT or UST tires**. With this Tublesskit you can avoid tube changes and repairs and at the same time **reduce weight**.

- 1) Every **conventional rim** can be converted to a **tubeless system at low costs**.
- 2) M-Wave Tublesskit is also **usable for Kenda SCT tires**. Through this you can ride a tubeless system without having to accept the higher weight and costs of UST tires.
- 3) With the M-Wave tubelesskit **only 2 bar air pressure** are required without the risk of damaging the tire by snakebite (rim cut through the tire). The effects:
 - a) **distinctly improved damping**
 - b) **improved traction** in every terrain
 - c) uphill one can stay longer in the saddle
 - d) and downhill the **braking is improved**
 - e) more **grip in turns**
 - f) due to the above advantages **smaller and lighter tires** can be used.
- 4) Through the use of this tubeless system the **rolling resistance**, in comparison with a tube system, is about **15 % lower**.
- 5) Tubeless tires cannot be manufactured 100 % airtight. M-Wave tubelesskit makes them **self-repairing**- sealing liquid closes holes or other damages up to **6 mm diameter automatically and permanently**. It keeps this function for **longer than 6 months**.



TUBELESS HOCHDRUCK-FELGENBAND

- **selbstklebend**
- 10 Meter gerollt
- im Polybeutel mit M-Wave Eurolochheader

Breite:

519850 9,90 €	19 mm
519822 11,90 €	21 mm
519852 11,90 €	23 mm
519853 12,90 €	25 mm
519825 13,90 €	27 mm
519842 13,90 €	30 mm
519843 13,90 €	35 mm

TUBELESS HIGH PRESSURE RIM TAPE

- **adhesive**
- 10 meters rolled
- in PE bag with M-Wave eurohole header

width:

19 mm
21 mm
23 mm
25 mm
27 mm
30 mm
35 mm



TUBELESS VENTIL

- **Carbon**
- inkl. **2 runder und 2 eckiger Dichtungen**
- **seitlicher Luftauslass**
- mit **Ventilwerkzeug/-kappe** (Art. 519819)
- 2x FV
- mit Befestigungsmuttern
- 1 Paar in M-Wave Eurolochbox

Höhe: 35 mm

519870	Höhe: 35 mm
519871	Höhe: 45 mm

14,90 € / pair

TUBELESS VALVE

- **carbon**
- incl. **2 round and 2 square seal rings**
- **lateral air outlet**
- with **valve tool/cap** (art. 519819)
- 2x FV
- with fixing nuts
- 1 pair in M-Wave eurohole box

height: 35 mm

height: 45 mm



ART.-NR. BESCHREIBUNG
UVP

DESCRIPTION

519463 ABDICHTFLÜSSIGKEIT
›TUBELESS SEALANT‹
9,90 €

- Abdichtflüssigkeit für **Tubeless-Reifen**
- versiegelt unmittelbar Löcher von bis zu 6 mm in der Lauffläche
- Dichtmittel ist **CO₂-Patronen-kompatibel**
- 125 ml

TIRE SEALANT
›TUBELESS SEALANT‹

- sealant for **tubeless tires**
- instantly seals puncture in tread up to 6 mm
- sealant is **CO₂ cartridge compatible**
- 125 ml



519828 TUBELESSKIT & PANNENSCHUTZ
›TU-KIT‹
39,90 €

20" - 29"

- 1 Set für **2 Reifen** bestehend aus:
 - 2 x F/V Tubeless-Ventile 47 mm
 - 1 x 10 m-Rolle selbstklebendes Tubeless-Felgenband, Breite 25 mm
 - 2 x 125 ml Abdichtflüssigkeit
 - Ventilwerkzeug
- in M-Wave Eurolochbox

TUBELESSKIT & FLAT PREVENTION
›TU-KIT‹

- 1 set for **2 wheels** consisting of:
 - 2 x F/V tubeless valves 47 mm
 - 1 x 10 m roll adhesive tubeless rim tape, width 25 mm
 - 2 x 125 ml tubeless sealant
 - valve tool
- in M-Wave eurohole box



Gerne stellen wir für Sie Ihr individuelles Tubeless-Set zusammen. Wählen Sie dabei ein Felgenband in der passenden Breite und die passenden Ventile aus. Dazu kommt zu jedem Set das Ventilwerkzeug (Art. 519819) und zwei Flaschen Dichtflüssigkeit (Art. 519463).

We gladly arrange your individual tubeless set. Choose one rim tape in the appropriate width and the suitable valves. With every set comes a valve tool (art. 519819) and two bottles of sealant fluid (art. 519463).

519461 TUBELESSKIT & PANNENSCHUTZ
26" - 29" ›ECO‹
31,90 €

26" - 29"

- für fast alle handelsüblichen Hohlkammerfelgen mit FV-Felgenloch
- Felgenbreite 17 - 19 mm (innen)
- 1 Set für **2 Reifen** bestehend aus:
 - 2 x 125 ml **Abdichtflüssigkeit** für Löcher bis **6 mm**
 - doppelseitiges Klebeband
 - 2 x Felgenband mit Ventileinbaukit
- Abdichtflüssigkeit **umweltfreundlich** und **latexfrei**
- in M-Wave Eurolochbox

TUBELESSKIT & FLAT PREVENTION
26" - 29" ›ECO‹

- for almost all conventional double wall rims with FV rim hole
- rim width 17 - 19 mm (inner)
- 1 set for **2 wheels** consisting of:
 - 2 x 125 ml **tubeless sealant** for holes up to **6 mm**
 - double sided glue strip
 - 2 x rim tape with valve mounting kit
- Eco sealant **eco-friendly** and **latex-free**
- in M-Wave eurohole box



518817 REIFEN- UND SCHLAUCH-PANNENSCHUTZ-FLÜSSIGKEIT
6,90 €

- verhindert und repariert Pannen an Schläuchen und Reifen jeglicher Art
- **dichtet Schäden bis 3 mm selbständig** während der Fahrt ab
- **mit Ventilschlüssel** zum Herausnehmen des Ventileinsatzes beim A/V
- spitzes Ventil zum **leichten Befüllen**
- im **Einzelkarton**, 16 Stück à **250 ml** im mehrsprachigen, verkaufsfördernden **Thekendisplay**

TIRE AND TUBE SEALANT

- prevents and repairs flat tires and tubes of any kind
- **seals damages up to 3 mm automatically** during ride
- **with valve key** to take out the valve from A/V
- pointed valve for **easy filling**
- in **single box**, 16 pcs à **250 ml** in multilingual sales promotion **display box**



ART.-NR. UVP

DESCRIPTION

880267 REIFENFLICK-SET ›TUBELESS FIX‹

15,90 €

- in hochwertigem **Aluminium**-Gehäuse
- 2 Funktionen: Reifen Reibahle und Einführwerkzeug
- verschieden dicke Streifen für kleine und große Löcher:
5 x Ø 1,5 mm
3 x Ø 3,5 mm
- **Gehäuse dient bei Verwendung als Hebel**
- auf M-Wave Eurolochkarte

TUBELESS REPAIR KIT ›TUBELESS FIX‹

- in high quality **aluminium** case
- 2 functions: tire reamer and insert tool
- stripes in different widths for small and big holes:
5 x Ø 1.5 mm
3 x Ø 3.5 mm
- **case useable as lever**
- on M-Wave eurohole card



880365 TUBELESS REPAIR KIT ›TUBELESS FIX ECO‹

8,90 €

- mit zwei unterschiedlich dicken **Reibahlen** und **Einführungs-
werkzeug**
- verschieden dicke Streifen für kleine und große Löcher
- 5 x Ø 1,5 mm
- 5 x Ø 3,5 mm
- in M-Wave Kunststoff-Box

TUBELESS REPAIR KIT ›TUBELESS FIX ECO‹

- with two tire **reamers** of different thicknesses and **insert tool**
- stripes in different widths for small and big holes
- 5 x Ø 1,5 mm
- 5 x Ø 3,5 mm
- in M-Wave plastic box



519481 BEFÜLLSPRITZE FÜR DICHTMILCH

16,90 €

AV/FV

- ermöglicht **schnelles, sauberes und kontrolliertes befüllen der Dichtmilch**
- **keine Demontage** des Reifens nötig
- Dichtmilch kann (für mehr Pannenschutz) auch in einen vorhandenen Schlauch gefüllt werden
- Schraubadapter für **AV und FV**
- Behältnis kann bis zu **60 ml** Dichtmilch aufnehmen
- es kann **jede Dichtmilch** verwendet werden, besonders geeignet für Art. 519463
- in M-Wave Eurolochbox

SEALANT SYRINGE INJECTOR

- **quick, clean and controlled filling of the sealant**
- **no tire demounting** necessary
- sealant can also be applied to inner tubes (for additional puncture control)
- screw-on adapter for **AV and FV**
- for up to **60 ml** sealant
- compatible for **all sealants**, especially suitable for art. 519463
- in M-Wave eurohole box



ART.-NR. UVP	BESCHREIBUNG	DESCRIPTION
	HOCHDRUCK-FELGENBAND	HIGH PRESSURE RIM TAPE
	Top-Qualität	Top quality
	20 mm x 26" , 20-559	20 mm x 26" , 20-559
519200 3,90 € / pair	2 Stück in M-Wave Eurolochbox	2 pieces in M-Wave eurohole box
519340 1,90 €/pc.	Montageverpackung	OEM
	20 mm x 27,5" , 20-584	20 mm x 27.5" , 20-584
519201 3,90 € / pair	2 Stück in M-Wave Eurolochbox	2 pieces in M-Wave eurohole box
519309 1,90 €/pc.	Montageverpackung	OEM
PLUS	24 mm x 27,5" , 24-584 passend für viele Plus -Felgen (z.B. Art. 381150 ff., 380480 ff., ...)	24 mm x 27.5" , 24-584 suitable for a lot of plus rims (e.g. art. 381150 et seq., 380480 et seq., ...)
519205 4,90 € / pair	2 Stück in M-Wave Eurolochbox	2 pieces in M-Wave eurohole box
519371 2,40 €/pc.	Montageverpackung	OEM
	16 mm x 28" / 29" / 700C , 16-622	16 mm x 28" / 29" / 700C , 16-622
519203 3,90 € / pair	2 Stück in M-Wave Eurolochbox	2 pieces in M-Wave eurohole box
519341 1,90 €/pc.	Montageverpackung	OEM
	20 mm x 28" / 29" , 20-622	20 mm x 28" / 29" , 20-622
519204 3,90 € / pair	2 Stück in M-Wave Eurolochbox	2 pieces in M-Wave eurohole box
519342 1,90 €/pc.	Montageverpackung	OEM
PLUS	24 mm x 28" / 29" , 24-622	24 mm x 28" / 29" , 24-622
519206 2,40 €/pc.	Montageverpackung	OEM



SELBSTKLEBENDES HOCHDRUCK-GEWEBE-FELGENBAND

- aus sehr hochwertigem, 0,5 mm starkem, blauem **Nylongewebe**
- eine spezielle Klebeschicht **verhindert Verrutschen** auch bei starker Belastung und hohen Temperaturen
- sehr **leicht** (nur 15 g bei 16-622)
- passend für **12" - 29"**
- mit Ventilloch
- **1 Paar** = 2 x 2 m in Polybeutel mit M-Wave Eurolochheader

SELF-ADHESIVE HIGH PRESSURE TEXTILE RIM TAPE

- **high-grade, 0.5 mm thick, blue nylon fabric**
- the special glue layer **prevents** the tape from **slipping**, even at intense strain or high temperatures
- very **light** (only 15 g in size 16-622)
- suitable for **12" - 29"**
- with valve hole
- **1 pair** = 2 x 2 m in PE-bag with M-Wave eurohole header



519400 16 mm
519401 20 mm
4,90 € / pair

16 mm
20 mm

519909 VENTILKAPPEN-SET

- 44,90 € / set
- **eloxiertes Aluminium**
 - für **AV** (und **FV**) geeignet durch Doppelgewinde
 - 30 Stück, farbig sortiert
 - in M-Wave Thekendisplay

VALVE CAP SET

- **anodised aluminium**
- suitable for **AV** (and **FV**) due to double threading
- 30 pieces, assorted colours
- in M-Wave sales display



ART.-NR. BESCHREIBUNG
UVP

DESCRIPTION

640093

**HARTSCHALEN-
GEPÄCKANHÄNGER
›STALWART CARRY BOX‹**

629,00 €



- Zweispuranhänger mit **Hartschalen-Gepäckbox**
- Inhalt ca. 70 Liter, Box-Größe ca. 60 cm x 68 cm x 27 cm (B x L x H)
- **100 % wasserdicht**
- **abschließbar** mit Sicherheitsschloss
- bequemes und sicheres Be- und Entladen durch **hydraulisches Deckelöffnungsgestänge**
- mit **Gepäckträger auf dem Deckel**
- auch als **Handwagen, Einkaufswagen, ...** verwendbar
- **Aluminium-Rahmen, -Naben und -Felgen**
- abnehmbare **20" Laufräder mit Luftbereifung und Schnellverschluss**
- mit **Sicherheitsabweiser**
- mit **Schnellverschluss-Universalkupplung** (Art. 640028)
- max. Zuladung 25 kg, davon 3 kg auf dem Deckel

**HARD BOX LUGGAGE
TRAILER
›STALWART CARRY BOX‹**

- double track luggage trailer with **hard luggage box**
- content approx. 70 ltrs, box size approx. 60 cm x 68 cm x 27 cm (W x L x H)
- **100 % waterproof**
- **lockable** by safety lock
- easy and safe (un)loading through **hydraulic lid**
- with **carrier on the lid**
- also usable as **hand cart, shopping trolley, ...**
- **aluminium** frame, hubs and rims
- detachable **20" wheels** with **air tires** and **QR**
- with **safety bumper**
- with **QR universal hitch** (art. 640028)
- max. load 25 kg, thereof 3 kg on lid



Trailers

640005

**GEPÄCKANHÄNGER
›STALWART SHOP 2‹**

289,00 €



- **3 in 1** Anhänger: als **Fahrradanhänger**, bequemer **Einkaufstrolley** und **Sackkarre** verwendbar
- **werkzeuglos klappbare Anhängedeichsel**
- stabiler und leichter **Aluminium-Rahmen**
- mit Anhängerkupplung zur Befestigung an der Sattelstütze
- leichte 12" Laufräder mit **Kenda Luftreifen**, Aluminiumfelgen und Edelstahlspeichen
- mit **großer** (53 x 37 x 26 cm (H x B x T), Volumen: 51 L) und **kleiner** (24 x 37 x 26 cm (H x B x T), Volumen: 23 L) **clip-on Gepäcktasche**
- Rücken aus Nylon 600D verhindert das Verschmutzen der Taschen
- ohne Tasche auch als leichte **Sackkarre** verwendbar
- max. Zuladung 21,4 kg
- Außenmaße (kompletter Anhänger, ausgeklappt) ca. 125 x 56 x 90 cm (L x B x H)

**LUGGAGE TRAILER
›STALWART SHOP 2‹**

- **3 in 1** trailer: as **bicycle trailer**, comfortable **shopping trolley** and **sacktruck** usable
- **toolless foldable trailer drawbar**
- strong and lightweight **aluminium** frame
- with trailer coupling for fastening at the seatpost
- lightweight 12" wheels with **Kenda air tires**, aluminium rims and stainless steel spokes
- with **big** (53 x 37 x 26 cm (H x W x D), Volumen: 51 L) and **small** (24 x 37 x 26 cm (H x W x D), Volumen: 23 L) **clip-on pannier**
- back made of nylon 600D prevents the bags from getting dirty
- without pannier also usable as lightweight **sacktruck**
- max. load 21.4 kg
- measurement outside (complete trailer, unfolded) approx. 125 x 56 x 90 cm (L x W x H)



ART.-NR. UVP **BESCHREIBUNG**

DESCRIPTION

640060 FALT-GEPÄCKANHÄNGER ›STALWART CARRY FOLD 2‹

269,00 €

- **faltbarer Rahmen** aus Stahl
- Laufräder mit Schnellverschluss
- max. Zuladung 40 kg
- Aufsatzgröße außen:
(L) = 690 x (B) = 480 x (H) = 260 mm

FOLDABLE LUGGAGE TRAILER ›STALWART CARRY FOLD 2‹

- **foldable frame** made of steel
- wheels with quick release
- max. load 40 kg
- frame measurement outside:
(L) = 690 x (W) = 480 x (H) = 260 mm



640063 HANDDEICHSEL

27,90 €

- für Art. 640060
- mit weichem Schaumstoffgriff
- Kupplung (Art. 640070/1) montierbar

HAND TOWING BAR

- for art. 640060
- with soft foam grip
- hitch (art. 640070/1) mountable



640047 EINSPUR-GEPÄCKANHÄNGER ›STALWART SINGLE 40‹

195,00 €

7,6 kg

- **Einspur-Anhänger** mit Lenkgelenk
- universelles **Schnellspannsystem** zur Befestigung an der Hinterachse (wir empfehlen Adapter für 10 mm Festachse Art. 640077, Adapter für Nexus 8-Gang = 3/8" Gewinde Art. 640078), mit Sicherheitshaken (Art. 640127)
- **faltbarer**, stabiler Stahlrahmen
- 16" Laufrad mit **Aluminiumnabe**, mit **Schnellspanner**, **Aluminiumfelge** und **Kendareifen**
- mit Wimpel
- max. Zuladung 27 kg
- ebener Lochblechboden, Maße ca. 61 x 40 / 30 cm
- Außenmaße ca. (L) = 131 x (B) = 44 x (H) = 28 cm

SINGLE TRACK LUGGAGE TRAILER ›STALWART SINGLE 40‹

- **single track** trailer with steering joint
- universal **quick release system** for mounting at the rear axle (we recommend an adapter for 10 mm solid axle art. 640077, adapter for Nexus 8 speed = 3/8" thread art. 640078), with safety hooks (art. 640127)
- **foldable**, stable steel frame
- 16" wheel with **aluminium** hub, with **QR**, **aluminium** rim and **Kenda** tire
- with pennant
- max. load 27 kg
- flat perforated plate bottom, size approx. 61 x 40 / 30 cm
- measurement outside approx. (L) = 131 x (W) = 44 x (H) = 28 cm

122522 Tasche für Einspur-Gepäckanhänger Art. 640047

49,90 €

- **wasserdicht**
- **universell einsetzbar** auch als Reisetasche,...
- Volumen ca. 120 Liter, ca. 60 x 38,5 x 55 cm

bag for single track luggage trailer art. 640047

- **waterproof**
- **universally applicable** also as a travel bag,...
- volume approx. 120 litres, approx. 60 x 38.5 x 55 cm

640081 Set aus Einspur-Gepäck-Fahrradanhänger Art. 640047 und Tasche Art. 122522

239,00 €

set of single track luggage bicycle trailer art. 640047 and bag art. 122522

640002 Adapter für Steckachsen ›Stalwart Thru‹

29,90 €

- ermöglicht die Verwendung des **Einspur-Gepäckanhängers** (Art. 640047) in Verbindung mit einer **Steckachse** mit Innengewinde (Art. 640140, 640141, 640142)
- im Polybeutel mit M-Wave Eurolochheader

adapter for thru axles ›Stalwart Thru‹

- enables usage of the **single track luggage trailer** (art. 640047) in connection with **thru axles** with internal thread (art. 640140, 640141, 640142)
- in PE bag with M-Wave eurohole header



ART.-NR. BESCHREIBUNG
UVP

DESCRIPTION

640073 FALT-GEPÄCKANHÄNGER
›STALWART CARRY FOLD 1‹

429,00 €

2 IN 1

- **Aluminium-Rahmen**, silber, pulverbeschichtet
- mit **zusätzlicher verstellbarer Handdeichsel** und **Abstellhilfe**
- 20" Laufräder mit Schnellverschluss und **Aluminiumfelgen**
- max. Gesamtgewicht 30 kg
- Ablagefläche 67 x 44 x 37 cm
- mit Reflektoren
- mit Gepäcktasche (90 l) aus 600D Polyestergerewebe

FOLDABE LUGGAGE TRAILER

›STALWART CARRY FOLD 1‹

- **aluminium frame**, silver, powder-coated frame
- with **additional adjustable hand tow bar** and **parking stand**
- 20" quick release wheels with **aluminium rims**
- max. total weight 30 kg
- platform size 67 x 44 x 37 cm
- with reflectors
- with luggage bag (90 l) made of 600D polyester



640046 KINDER-, GEPÄCK- UND JOGGING FAHRRADANHÄNGER/-WAGEN
›STALWART KID 3IN1‹

395,00 €

3 IN 1

- in Sekunden, **ohne Werkzeug** umbaubar vom **Fahrrad-anhänger zum Kinderwagen oder Jogger**
- 20" Laufräder mit **Schnellverschluss** und **Sicherheitsbügel**
- **zusätzliches 12" Laufrad**
- mit feststellbarer **Handbremse**
- mit **Wegfahrsperr**
- **faltbar**
- Bespannung aus 600 D Polyestergerewebe
- mit **Sicherheitsreflexdreieck** auf der Rückseite
- mit Reflektoren
- 2-sitzig mit Sicherheitsgurten und Überrollbügel
- abnehmbare Überdachung, mit Dachfenster (Art. 640016)
- mit Fliegengitter
- mit Wimpel
- mit Regenschutz
- mit zusätzlichem Stauraum für Gepäck
- mit 2 Innentaschen für Kleinutensilien
- mit **Schnellverschluss** Universal-Kupplung für's Fahrrad
- geprüft gemäß EN 15918
- max. Zuladung bei Gebrauch als Jogger: 32,2 kg
- max. Zuladung als Anhänger: 20,2 kg
- Außenmaße: 61 cm (B) x 75 cm (L) x 28 cm (Sitzhöhe)

CHILDREN, LUGGAGE AND JOGGING BICYCLE TRAILER/VAN

›STALWART KID 3IN1‹

- in seconds, **toolless** changeable from **bicycle trailer to baby van or jogger**
- 20" wheels with **quick release** and **safety bow**
- **additional 12" wheel**
- with fixable **handbrake**
- with **parking brake**
- **foldable**
- covering made of 600 D polyester
- with **safety reflex triangle** on the back
- with reflectors
- 2 seats with safety belts and with roll-over bar
- with detachable roof, with window (art. 640016)
- with fly-screen
- with pennant
- with rain protection
- with additional room for luggage
- with 2 inside pockets for small parts
- with universal **quick release** adapter for bicycle
- tested according to EN 15918
- max. load when using as jogger: 32.2 kg
- max. load as trailer: 20.2 kg
- measurement outside: 61 cm (W) x 75 cm (L) x 28 cm (seat height)



ART.-NR. UVP **BESCHREIBUNG** **DESCRIPTION**

640092 **GEFEDERTER ALUMINIUM KINDER- UND GEPÄCK-FAHRRADANHÄNGER**
 ›STALWART KID 2‹
 459,00 €

- mit faltbarem **Aluminium**-Rahmen
- **vollgefedert**
- **20"** Laufräder mit **Schnellverschluss**
- **Aluminium**felgen
- Bespannung aus 600D Polyestergewebe
- mit **Sicherheitsreflexdreieck** auf der Rückseite
- mit Reflektoren
- 2-sitzig mit Sicherheitsgurten
- mit Überrollbügel
- abnehmbare Überdachung (Art. 640016)
- mit Fliegengitter und Regenschutz
- mit Wimpel
- mit zusätzlichem Stauraum für Gepäck
- mit 2 Innentaschen für Kleinutensilien
- mit **Schnellverschluss** Universal-Kupplung für´s Fahrrad
- geprüft gemäß EN 15918
- max. Zuladung: 20 kg
- Außenmaße: 60 cm (B) x 75 cm (L) x 28 cm (Sitzhöhe)

SUSPENSION ALUMINIUM CHILDREN AND LUGGAGE BICYCLE TRAILER
 ›STALWART KID 2‹

- with foldable **aluminium** frame
- **full suspension**
- **20"** wheels with **quick release**
- **aluminium** rims
- covering made of 600D polyester
- with **safety reflex triangle** on the back
- with reflectors
- 2 seats with safety belts
- with roll-over bar
- with detachable roof (art. 640016)
- with fly-screen and rain protection
- with pennant
- with additional room for luggage
- with 2 inside pockets for small parts
- with universal **quick release** adapter for bicycle
 - tested according to EN 15918
 - maximal load: 20 kg
 - measurement outside: 60 cm (W) x 75 cm (L) x 28 cm (seat height)



SUSPENSION



640052
Ersatzkupplung/
replacement adapter

KINDER- UND GEPÄCK-FAHRRADANHÄNGER

- **faltbar**
- **20"** Räder mit **Schnellverschluss**
- **Sicherheitsrahmen um die Laufräder**
- Bespannung aus 600D Polyestergewebe
- mit **Sicherheitsreflexdreieck** auf der Rückseite
- mit Reflektoren
- 2-sitzig mit Sicherheitsgurten
- mit Überrollbügel
- mit abnehmbarer Überdachung (Art. 640016)
- mit Fliegengitter
- mit Wimpel
- mit Regenschutz
- mit zusätzlichem Stauraum für Gepäck
- mit 2 Innentaschen für Kleinutensilien
- mit **Schnellverschluss** Universal-Kupplung für´s Fahrrad
- geprüft gemäß EN 15918
- max. Zuladung: 20 kg
- Außenmaße: 60 cm (B) x 75 cm (L) x 28 cm (Sitzhöhe)

CHILDREN AND LUGGAGE BICYCLE TRAILER

- **foldable**
- **20"** wheels with **quick release**
- **safety frame around the wheels**
- covering made of 600D polyester
- with **safety reflex triangle** on the back
- with reflectors
- 2 seats with safety belts
- with roll-over bar
- with detachable roof (art. 640016)
- with fly-screen
- with pennant
- with rain protection
- with additional room for luggage
- with 2 inside pockets for small parts
- with universal **quick release** adapter for bicycle
- tested according to EN 15918
- max. load: 20 kg
- measurement outside: 60 cm (W) x 75 cm (L) x 28 cm (seat height)

640091 ›STALWART KID EASY LIGHT‹
 Aluminium-Rahmen
 389,00 €

›STALWART KID EASY LIGHT‹
 aluminium frame

640090 ›STALWART KID EASY‹
 Stahlrahmen
 359,00 €

›STALWART KID EASY‹ steel frame



art. 640052
Ersatzkupplung/
replacement adapter

ART.-NR. **BESCHREIBUNG**
UVP

DESCRIPTION

640050 HUNDEFAHRRADANHÄNGER

239,00 €

›STALWART PET‹

- **faltbar**
- 16" Räder mit **Schnellverschluss**
- Bespannung aus 600D Polyestergerewebe (Ersatzüberdachung Art. 640001)
- zusätzliche/s **Fronttür/Sichtfenster**
- mit **Befestigungsöse** für Hundeleine innen
- mit **Überrollbügel**
- mit Wimpel
- mit Regenschutz
- mit **Schnellverschluss** Universal-Kupplung für's Fahrrad
- mit faltbarer Anhängestange
- max. Zuladung: 30 kg
- Außenmaße: 43,5 cm (B) x 68 cm (L) x 51,5 cm (H), gefaltet: Höhe ca. 19 cm

DOG BICYCLE TRAILER

›STALWART PET‹

- **foldable**
- 16" wheels with **quick release**
- covering made of 600D polyester (replacement canopy art. 640001)
- additional **front door/window**
- with **fastening eye** inside for a dog leash
- with **roll-over bar**
- with pennant
- with rain protection
- with universal **quick release** adapter for bicycle
- with foldable tow bar
- max. load: 30 kg
- measurement outside: 43.5 cm (W) x 68 cm (L) x 51.5 cm (H), folded: height approx. 19 cm



Trailers

ART.-NR. BESCHREIBUNG
UVP

DESCRIPTION



STECKACHSE FÜR ANHÄNGER-KUPPLUNG
›STALWART AXLE‹



- zur **werkzeuglosen Montage von Standard Fahrrad-Anhänger-Kupplungen** an **12 mm Steckachs-naben**
- **2 in 1:** durch 6 mm Distanzscheibe passend für 12 mm Steckachs-naben mit **142 mm** Einbaumaß und für **Boost-Naben** mit **148 mm** Einbaumaß
- Aluminium
- mit Schnellspanner
- auch **ohne Schnellspanner als saubere Lösung** für Steckachsen nutzbar
- mit **zusätzlichem Innengewinde** für M6-Schraube für z. B. Gepäckträgermontage
- mit zusätzlichen Unterlegscheiben zur **Einstellung der Schnellspannhebel-Position**
- auf M-Wave Eurolochkarte

640140 • **Shimano Type**
(kein original Shimano Ersatzteil)
• Gewindesteigung: P1.5 x T20

640141 • **Maxle Type**
(kein original Maxle Ersatzteil)
• Gewindesteigung: P1.75 x T20

640142 • **Syntace Type**
(kein original Syntace Ersatzteil)
44,90 € • Gewindesteigung: P1.0 x T20
• mit konischer Verbindungsscheibe

THRU AXLE FOR TRAILER MOUNT
›STALWART AXLE‹

- for **toolless mounting of standard bicycle trailer adapters** at **12 mm thru axle hubs**
- **2 in 1:** by 6 mm spacer suitable for 12 mm thru axle hubs with **OLD 142 mm** and for **boost hubs** with **OLD 148 mm**
- aluminium
- with QR
- also usable **without QR as clean solution** for quick-release axle
- with **additional internal thread** for M6 screw for e. g. luggage rack mounting
- with additional spacers for **adjusting the QR lever position**
- on M-Wave eurohole card

• **Shimano Type**
(no original Shimano spare part)
• thread pitch: P1.5 x T20

• **Maxle Type**
(no original Maxle spare part)
• thread pitch: P1.75 x T20

• **Syntace Type**
(no original Syntace spare part)
• thread pitch: P1.0 x T20
• with conical spacer

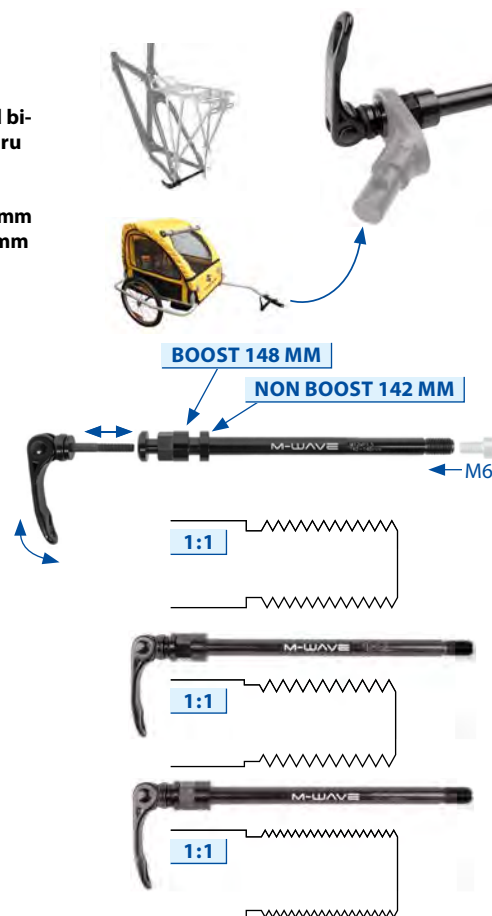

440490 SCHNELLSPANNER

- 9,90 €
- zur **Montage von Gepäckträgern** an Räder:
 - **ohne Befestigungsösen** (z. B. Rennräder)
 - mit **hinderlichen Sitzrohr- oder Kettenstreben, Ausfallenden, ...**
 - passend auch für **Fahrradanhänger** Art. 640050, ...
 - mit 8 je 5 mm breiten **Adapter-scheiben**
 - **Aluminiumhebel**
 - Länge 210 mm
 - für Nabeneinbaumaß: ≥ 130 mm
 - **Klemmbreite: 137 mm - 177 mm** (in 5 mm Schritten)
 - auf M-Wave Eurolochkarte

QUICK RELEASE

- for **mounting of carriers** to bicycles:
 - **without mounting eyelets** (e. g. road bikes)
 - with **obstructive seat stays, chain stays, derailleur hangers, ...**
- also suitable for **bicycle trailer** art. 640050, ... with 8 **adapters**, each 5 mm wide
- **aluminium lever**
- length 210 mm
- OLD: ≥ 130 mm
- **clamp width: 137 - 177 mm** (in 5 mm steps)
- on M-Wave eurohole card



640104 HUNDELEINENFÜHRUNG-STANGE ›DOG WALK‹
26,90 €

- stabile Feder
- Befestigung an der Sattelstütze, Sattelrohr, ...
- **Schnellspanverschluss**
- inkl. Hundeleine 92 cm
- auf M-Wave Eurolochkarte

DOG GUIDE ›DOG WALK‹

- stable spring
- attachment at the seatpost, seat tube, ...
- **quick release**
- incl. dog leash 92 cm
- with M-Wave eurohole card



ART.-NR. BESCHREIBUNG
UVP

DESCRIPTION



FAHRRAD-ABSCHLEPPSEIL
›TRAIL ROPE‹

- **Abschlepphilfe** für z. B. Kinder, Jugendliche, Erwachsene, ...
- **enorme Belastbarkeit** durch Nylonummantelung
- mit **Bungee-Gummiband** für sanftes Anfahren
- inkl. 2 Karabinerhaken und 2 Gurtbänder für einfache, werkzeuglose Montage an Sattel oder Sattelstütze des Zugrads und an Lenker, Vorbau oder Rahmendreieck des gezogenen Fahrrads
- inkl. Tasche zur Befestigung am Sattelgestell, Rahmen, ...
- im M-Wave Einzelkarton

BICYCLE TOW ROPE
›TRAIL ROPE‹

- **tow assist** for e. g. children, youths, adults, ...
- **huge resilience** due to nylon coating
- with **bungee rubber band** for gentle start
- incl. 2 carabiners and 2 webbing bands for easy, toolless mounting on saddle or seat post of the towing bike and on handlebars, handle stem or frame triangle of the towed bike
- incl. storage bag for mounting to the saddle rail, frame, ...
- in M-Wave box



640026 besonders geeignet für **schwere** Anhängelasten (**Erwachsene**, ...), für bis zu 170 kg Gesamtanhängelast empfohlen

especially suitable for **heavy** trailer loads (**adults**, ...), recommended for up to 170 kg total load

640027 besonders geeignet für **leichtere** Anhängelasten (**Kinder/Jugendliche**, ...), für bis zu 100 kg Gesamtanhängelast empfohlen
39,90 €

especially suitable for **lighter** trailer loads (**kids / youths**, ...), recommended for up to 100 kg total load

640156 **HÜFTGURT**
›TRAIL ROPE HIKING STRAP‹
11,90 €

- **einstellbarer** Hüftgurt für **universellen** Einsatz
- für Abschleppseil Art. 640026/7
- ca. 40 x 1.330 mm
- auf M-Wave Eurolochkarte

HIPBELT
›TRAIL ROPE HIKING STRAP‹

- **adjustable** hipbelt for **universal** usage
- for tow rope art. 640026/7
- approx. 40 x 1,330 mm
- on M-Wave eurohole card



ART.-NR. BESCHREIBUNG
UVP

DESCRIPTION

659688 TRAININGSROLLE

179,00 €



- ›YOKE ´N´ROLL 65‹**
- **Gabel** mit Schnellspanner sicher und einfach **fixierbar**
 - für **26" - 29"**
 - **Länge werkzeuglos an Radstand anpassbar**
 - leises Laufgeräusch
 - Trainingseffekt über Gangschaltung am Rad **veränderbar**
 - kleiner Tritt zum leichteren Aufsteigen
 - platzsparende Aufbewahrung, da zusammenschiebbar
 - werkzeuglose und schnelle (De-)Montage
 - im Einzelkarton

ROLL EXERCISE TRAINER

- ›YOKE ´N´ROLL 65‹**
- **fork** can be **fixed** safely and easily with quick release
 - for **26" - 29"**
 - **length can be adapted to the wheel-base without tools**
 - low noise emission
 - training effect **can be changed** via gear shift on the bike
 - mini step for easy access
 - space-saving storage due to foldability
 - toolless and fast (dis-)assembly
 - in box



659687 ROLLENTRAINER

148,00 €

- ›YOKE ´N´ROLL 10‹**
- 2 oversized Stahl-Standrohre mit zusätzlicher Seitenabstützung
 - ergonomische **Schnelleinspann-** und Einstellgriffe
 - für **26" - 29"**
 - einstellbare **Magnetbremse**
 - leises Laufgeräusch
 - Widerstand **8-fach verstellbar mit Fernbedienung** (für Lenker Ø 22,2 - 31,8 mm)
 - **zusammenklappbar**
 - im Einzelkarton

ROLL EXERCISE TRAINER

- ›YOKE ´N´ROLL 10‹**
- 2 oversized steel main tubes with additional side stability tubes
 - ergonomic **quick mounting** and adjusting handles
 - for **26" - 29"**
 - adjustable **magnet brake**
 - low noise emission
 - resistance **adjustable in 8 steps with remote** (for handlebar Ø 22.2 - 31.8 mm)
 - **foldable**
 - in box

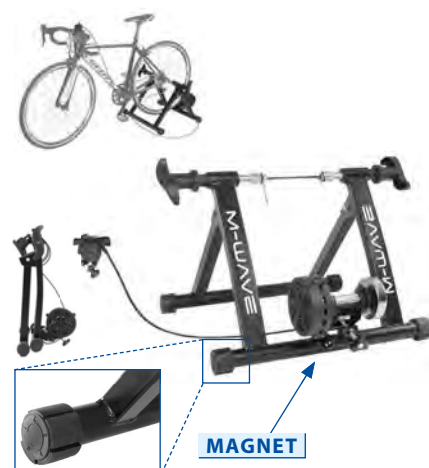

659686 ROLLENTRAINER

139,00 €

- ›YOKE ´N´ROLL 60‹**
- 2 oversized Stahl-Standrohre mit Seitenabstützung
 - ergonomische Einspann- und Einstellgriffe
 - inkl. **Schnellspanner**
 - für **26" - 29"**
 - einstellbare **Magnetbremse** durch Anpressdruck
 - **leises Laufgeräusch**
 - **klappbar**
 - im Einzelkarton

ROLL EXERCISE TRAINER

- ›YOKE ´N´ROLL 60‹**
- 2 oversized steel main tubes with side stability tubes
 - ergonomic mounting and adjusting handles
 - incl. **quick release**
 - for **26" - 29"**
 - adjustable **magnet brake** by contact pressure
 - **low noise emission**
 - **foldable**
 - in box



FEDERUNGSELEMENT

- **Aluminium-Körper**
- schwarze Stahlfeder
- **einstellbar**
- für Hinterbau
- Federweg 34 mm
- 650 lbs
- mit Befestigungsschrauben
- Montageverpackung

REAR SHOCK

- **aluminium** body
- black steel spring
- **adjustable**
- for rear stay
- travel 34 mm
- 650 lbs
- with fixing screws
- OEM

660431 Einbaumaß: **150 mm x 24/24 mm**

13,90 €

eye to eye: **150 mm x 24/24 mm**

660430 Einbaumaß: **165 mm x 24/24 mm**

14,90 €

eye to eye: **165 mm x 24/24 mm**



ART.-NR. UVP **BESCHREIBUNG**

DESCRIPTION

680280 **SCHALTWERK-ADAPTER**
9,90 € **›ADA RANGE‹**

- Aluminium
- **ermöglicht die Verwendung von wide-range Kassetten** mit großen Ritzeln, ohne dass ein Kettenwechsel mit längerem Käfig nötig ist
- besonders geeignet zum Umbau auf 1-fach Kettenradgarnitur
- auf M-Wave Eurolochkarte

REAR DERAILLEUR ADAPTER
›ADA RANGE‹

- aluminium
- **allows the installation of wide-range cassettes** with large sprockets, without the need for a chain change with a longer cage
- especially suitable for conversion to 1 speed chainwheel set
- on M-Wave eurohole card



SCHALTUNGSRÄDCHEN
›PULLEY GUIDE‹

- **seitliche Beweglichkeit** des oberen Schaltungsradchens **optimiert die Schaltfunktion**
- 2 Stück = 1 Set (mit 2 Rädchen, 4 Schalen, 2 Hülsen und 2 Schrauben)
- 11 Zähne
- passend für 9/10-fach
- **lange Haltbarkeit** durch eingepresste Metallhülsen und hochwertige Gleitlager

PULLEY SET
›PULLEY GUIDE‹

- **sidewise movability** of the upper pulley **optimises the shifting performance**
- 2 pieces = 1 set (with 2 pulleys, 4 cups, 2 bushes and 2 bolts)
- 11 teeth
- suitable for 9/10 speed
- **long durability** because of pressed in metal bushes and high quality slide bearings



680290 auf M-Wave Eurolochkarte
680291 Montageverpackung
14,90 € / set

on M-Wave eurohole card
OEM

ÜBERSCHUH

- aus **Neopren**
- unten mit Aussparungen für Klick-Pedale
- hinten **leichter Einstieg** durch Klettverschluss
- mit **Reflexstreifen**
- paarweise auf M-Wave Eurolochkarte

SHOE COVER

- made of **neoprene**
- with recess below for clipless pedals
- **easy access** by hook and loop fastener at the back
- with **reflective tape**
- one pair on M-Wave eurohole card



715312 Größe S/M
715313 Größe M/L
715314 Größe L/XL
21,90 €

size S/M
size M/L
size L/XL

715311 **SILIKON-ÜBERSCHUH**
12,90 € **›TOE SHIELD‹**

- **langlebiges, strapazierfähiges Silikon**
- **flexible, universelle** Passform (S-XL)
- **schützt** vor Wind und Nässe
- schnell übergestülpt mit Zuglasche
- **Verstärkung** im Zehen- und Laufbereich
- unten mit Aussparung für Schuhplatten
- paarweise auf M-Wave Eurolochkarte

SILICONE SHOE COVER
›TOE SHIELD‹

- **long-lasting, durable silicone**
- **flexible, universal fit** (S-XL)
- **protects** against wind and wetness
- quickly put on with strap
- **reinforced** at the toe and running area
- recess below for cleats
- one pair on M-Wave eurohole card



ARMLINGE UND BEINLINGE

- **leicht und klein**
- **trocknet** schnell
- **3D-Technologie**
- 98 % anti-UV bewirkt Temperatursenkung um bis zu 3 °C
- 80 % Polyamid, 20 % Spandex
- paarweise auf M-Wave Eurolochkarte

ARM- AND LEGWARMERS

- **light and small**
- **fast drying**
- **3D** technology
- 98 % anti UV lowers the temperature up to 3 °C
- 80 % Polyamid, 20 % Spandex
- one pair on M-Wave eurohole card

Armlinge

Armwarmers

715324 Größe S/M
715325 Größe L/XL
14,90 €

size S/M
size L/XL

Beinlinge

Legwarmers

715326 Größe S/M
715327 Größe L/XL
16,90 €

size S/M
size L/XL



ART.-NR. UVP **BESCHREIBUNG**

DESCRIPTION



HALS-/KOPFTUCH

- 100 % Polyester **Funktions-Microfaser**
- **nahtlos, elastisch** und **atmungsaktiv**
- Größe: ca. 24 x 48 cm
- auf M-Wave Eurolochkarte

TUBULAR HEADWEAR

- 100 % Polyester **function microfibre**
- **seamless, elastic** and **breathable**
- size: approx. 24 x 48 cm
- on M-Wave eurohole card

715179 ›Camouflage‹



›Camouflage‹

715196 ›White‹



›White‹

715197 ›Black‹



›Black‹

715206 ›Neon Yellow‹



›Neon Yellow‹

715199 ›Skull‹



›Skull‹

715122 ›Stripes B/W‹



›Stripes B/W‹

715116 ›White & Stripes‹



›White & Stripes‹

715126 ›Purple Squared‹



›Purple Squared‹

715205 ›Circles‹



›Circles‹

715129 ›Red/Blue Squared‹



›Red/Blue Squared‹

715128 ›Blue/Red Squared‹



›Blue/Red Squared‹

715204 ›Squares and Bubbles‹



›Squares and Bubbles‹

715124 ›Purple Squared‹



›Purple Squared‹

715194 ›M-Wave‹



›M-Wave‹

3,90 €

Ab einer Stückzahl von 450 Exemplaren erstellen wir Ihnen gerne ein Angebot für Ihr individuelles Design.

At a minimum of 450 pieces we will be able to make you an offer with your individual design.



Bike/Sportswear

715168 HALS-/KOPFTUCH ›BLACK FLEECE‹

5,90 €

- 100 % Polyester **Funktions-Microfaser** mit **Fleece-Einsatz**
- **elastisch** und **atmungsaktiv**
- Größe: ca. 24 x 70 cm
- auf M-Wave Eurolochkarte

TUBULAR HEADWEAR ›BLACK FLEECE‹

- 100 % Polyester **function microfibre** with **fleece application**
- **elastic** and **breathable**
- size: approx. 24 x 70 cm
- on M-Wave eurohole card



259891 KINDER-REGENPONCHO ›PONCHO KID´N´SEAT‹



34,90 €

- passend für **alle gängigen Kindersitze**
- geeignet **für Kinder von 6 Monaten bis 5 Jahren**
- mit Ärmeln für optimale Bewegungsfreiheit
- auch zur Abdeckung des Kindersitzes geeignet
- mit reflektierenden Elementen
- im Polybeutel mit Euroloch

RAIN COVER FOR CHILDREN SEAT ›PONCHO KID´N´SEAT‹

- suitable for **all common child seats**
- suitable for **children from 6 months to 5 years**
- with sleeves for optimal freedom of movement
- also useable for covering the baby seat
- with reflective elements
- in PE bag with eurohole



ART.-NR. UVP	BESCHREIBUNG	DESCRIPTION	
	<p>FAHRRADHANDSCHUHE ›ALASKA‹</p> <ul style="list-style-type: none"> • Windprotector außen • wärmendes Fleece innen • Non-Slip-Noppen für festen Griff • wasserabweisend • atmungsaktiv • mit reflektierendem Material von 3M Scotchlite an den Seiten • mit Gummizug • nur 122 g (M) • auf M-Wave Eurolochkarte 	<p>BICYCLE GLOVES ›ALASKA‹</p> <ul style="list-style-type: none"> • windprotector outside • warming fleece inside • non-slip knobs for a firm grip • water-repellent • breathable • with reflecting material of 3M Scotchlite on the sides • with rubber spring • only 122 g (M) • on M-Wave eurohole card 	 
719961	Größe M	size M	
719963	Größe L/XL	size L/XL	
15,90 € / pair			

	<p>GEL-FAHRRADHANDSCHUHE ›PROTECT SL‹</p> <ul style="list-style-type: none"> • Ganzfingerhandschuh mit integrierten Silikon-Protektoren • Geleinslagen verringern den Druck auf den Ulnarnerv und den Karpaltunnel. Dies hilft gegen einschlafende Hände. • Daumen und Zeigefinger mit spezieller Auflage zur Touchscreenbedienung • atmungsaktiv und waschbar • elastischer Bund mit hochwertigem Klettverschluss • Größe L • auf M-Wave Eurolochkarte 	<p>GEL BICYCLE GLOVES ›PROTECT SL‹</p> <ul style="list-style-type: none"> • full finger glove with integrated silicone protectors • gel inlays reduce pressure on the ulnar nerve and the carpal tunnel. This helps against paraesthesia in the hands. • thumb and forefinger with contact area for touchscreen operation • breathable and washable • elastic waistband with high quality hook and loop fastener • size L • on M-Wave eurohole card 	 <p>SILICONE PROTECTION</p>
719862	Größe L	size L	
18,90 € / pair			

	<p>GEL-FAHRRADHANDSCHUHE ›PROTECT HD‹</p> <ul style="list-style-type: none"> • Ganzfingerhandschuh mit integrierten Knöchel-Protektoren • Geleinslagen verringern den Druck auf den Ulnarnerv und den Karpaltunnel. Dies hilft gegen einschlafende Hände. • Daumen und Zeigefinger mit spezieller Auflage zur Touchscreenbedienung • integrierte Ausziehhilfe aus 3M Scotchlite • atmungsaktiv und waschbar • elastischer Bund mit hochwertigem Klettverschluss • auf M-Wave Eurolochkarte 	<p>GEL BICYCLE GLOVES ›PROTECT HD‹</p> <ul style="list-style-type: none"> • full finger glove with integrated knuckle protectors • gel inlays reduce pressure on the ulnar nerve and the carpal tunnel. This helps against paraesthesia in the hands. • thumb and forefinger with contact area for touchscreen operation • with loops as take-off assistance made of 3M Scotchlite • breathable and washable • elastic waistband with high quality hook and loop fastener • on M-Wave eurohole card 	 <p>PROTECTOR</p>
719856	Größe S	size S	
719857	Größe M	size M	
719858	Größe L	size L	
719859	Größe XL	size XL	
18,90 € / pair			

	<p>GEL-FAHRRADHANDSCHUHE ›GLOW‹</p> <ul style="list-style-type: none"> • neongelbe Sicherheitsfarbe • Geleinslagen verringern den Druck auf den Ulnarnerv und den Karpaltunnel. Dies hilft gegen einschlafende Hände. • mit 360° reflektierenden Applikationen • Daumen und Zeigefinger mit spezieller Auflage zur Touchscreenbedienung • mit Ausziehhilfe • außen teilweise aus elastischem Lycra • atmungsaktiv und waschbar • elastischer Bund • auf M-Wave Eurolochkarte 	<p>GEL BICYCLE GLOVES ›GLOW‹</p> <ul style="list-style-type: none"> • neon yellow safety colour • gel inlays reduce pressure on the ulnar nerve and the carpal tunnel. This helps against paraesthesia in the hands. • with 360° reflective applications • thumb and forefinger with contact area for touchscreen operation • with loops as take-off assistance • outside partly out of elastic lycra • breathable and washable • elastic waistband • on M-Wave eurohole card 	
719890	Größe S	size S	
719891	Größe M	size M	
719892	Größe L	size L	
719893	Größe XL	size XL	
13,90 € / pair			

ART.-NR. BESCHREIBUNG
UVP

DESCRIPTION



GEL-FAHRRADHANDSCHUHE ›GLOVERS‹

- **Geleinlagen** verringern den Druck auf den Ulnarnerv und den Karpaltunnel. Dies hilft gegen einschlafende Hände.
- mit **Schweißeinlage**
- mit **Ausziehhilfe**
- außen teilweise aus **elastischem Lycra**
- **waschbar** und **atmungsaktiv**
- **elastischer Bund** mit **hochwertigem Klettverschluss**
- auf M-Wave Eurolochkarte
- 5 Paar im Polybeutel, farbig sortiert

GEL BICYCLE GLOVES ›GLOVERS‹

- **gel inlays** reduce pressure on the ulnar nerve and the carpal tunnel. This helps against paraesthesia in the hands.
- with **sweat band**
- with **loops as take-off assistance**
- outside partly out of **elastic lycra**
- **washable** and **breathable**
- **elastic waistband** with **high-quality hook and loop fastener**
- on M-Wave eurohole card
- 5 pairs in PE bag, assorted colours



719935 Größe M

size M

719936 Größe L

size L

719937 Größe XL

size XL

8,90 €

715157 FAHRRADGARAGE ›CARGO‹

38,90 €

- **extra groß**, für einspurige Lastenräder, ideal für Transportfläche vorne
- **schützt** vor Sonne, Schnee, Regen,
- aus **widerstandsfähigem** Tarpaulin
- Größe ca. 290 x 120 x 70 cm
- mit elastischem Bund, Klett- und Schnellverschlussbändern
- Öffnung für sehr breite Lenker, Spiegel, ...
- im Polybeutel mit Euroloch

BICYCLE GARAGE ›CARGO‹

- **extra big**, for single-track cargo bikes, ideal for front transport surface
- **protects** from sun, snow, rain,
- made of **resistant** tarpaulin
- size approx. 290 x 120 x 70 cm
- with elastic waistband, hook and loop fastener and quick release tapes
- opening for very wide handlebars, mirrors, ...
- in PE bag with eurohole



715164 FAHRRAD-, ROLLERGARAGE

24,90 €

- **XXL-Größe**, ca. 230 x 135 x 65 cm
- **schützt vor Sonne, Schnee, Regen, ...**
- mit **Mittelverschluss**
- aus **widerstandsfähigem Tarpaulin**
- mit **Gummizug** (vorne und hinten)
- auch für **breite Lenker** und **Körbe** geeignet
- passend für alle gängigen Fahrräder, Roller, ...
- im Polybeutel mit Euroloch

BICYCLE, SCOOTER GARAGE

- **XXL size**, approx. 230 x 135 x 65 cm
- **protects from sun, snow, rain, ...**
- with **central closure**
- made of **resistant Tarpaulin**
- with **rubber straps** (front and rear)
- also suitable for **wide handlebars** and **baskets**
- suitable for all standard bicycles, scooters, ...
- in PE bag with eurohole



714841 INDOOR FAHRRADGARAGE ›VELOSOCK‹

49,90 €

- besonders geeignet für Wohnungen, Autos, ...
- ideal für 26" - 29" Fahrräder (1,6 - 2 m)
- 3D-stretch: sehr dehnbares Material, welches sich der jeweiligen Form des Fahrrads anpasst
- 90 % Polyester, 10 % Spandex
- waschmaschinenfest
- in Velosock Eurolochbox

INDOOR BICYCLE GARAGE ›VELOSOCK‹

- particularly suitable for flats, cars, ...
- ideal for 26" - 29" bicycles (1.6 - 2 m)
- 3D-stretch: very stretchable material which adapts to the shape of the bicycle
- 90 % Polyester, 10 % Spandex
- machine washable
- in Velosock eurohole box



ART.-NR. BESCHREIBUNG
UVP

DESCRIPTION



FAHRRAD-/SPORTBRILLEN
›RAYON‹

- **UV400-Schutz**
- ISO 12312-1 : 2015-12
- mit **Mikrofaser-Schutzhülle**
- mit fast **unzerbrechlichen** Polycarbonat **Sicherheitsgläsern**
- **Antikratzbeschichtung**
- in M-Wave Kunststoffbox

BIKE/SPORTS EYEWEAR
›RAYON‹

- **UV400 protection**
- ISO 12312-1 : 2015-12
- with **microfibre bag**
- with almost **unbreakable** polycarbonate **security lenses**
- **scratch proof treatment**
- in M-Wave plastic box

ISO 12312-1 : 2015-12



710169 FAHRRAD-/SPORTBRILLE
›RAYON PC ULTRA‹

52,90 €



- mit **photochromen Gläsern**: Photochrome Gläser sind Gläser, die durch ihre Schattierungstechnik mittels eines chemischen Prozesses **nachdunkeln** sobald sie der UV-Strahlung der Sonne ausgesetzt sind. Sie reagieren nicht auf künstliches Licht. Diese Gläser vereinen Mode und Komfort, bieten **Schutz** vor den schädlichen Auswirkungen der UV-Strahlung und vor Blendung. In dunkler Umgebung (Tunnel, Wald ...) hellen sie sich wieder auf.
- mit zusätzlichen **klaren, orangen, braunen Ersatzgläsern**
- **superleicht** und **extrem biegsam** durch **Grilamid-TR 90 Rahmen**
- mit **weichen** Nasenbügeln
- mit **weichen** Bügeleneinlagen
- Rahmen mattschwarz

BIKE/SPORTS EYEWEAR
›RAYON PC ULTRA‹

- with **photochromic lenses**: Photochromic lenses are the tint changing lenses that **darken** due to a chemical process when exposed to UV rays from the sun. They do not react to artificial light. These lenses combine fashion with comfort, offer **protection** from the damaging effects of UV radiation and glare. In dark surroundings (tunnel, forest ...) they will brighten again.
- with additional **clear, orange, brown spare lenses**
- **super light** and **extremely flexible** thru **Grilamid-TR 90 arms**
- with **soft** nose pads
- with **soft** temple tips
- frame matt black

EXTREMELY FLEXIBLE



NORMAL

UV-LIGHT



710170 FAHRRAD-/SPORTBRILLE
›RAYON G4 PRO‹

42,90 €



- Rahmen aus **Polycarbonat**
- mit **auswechselbaren, rot Iridium beschichteten** Gläsern
- mit zusätzlichen dunkel **entspiegelten, orangen** und **klaren** Ersatzgläsern
- mit **seitlichem Windschutz**
- mit **anatomischer Wangenform**
- mit **weichen, verstellbaren** Nasenbügeln
- Rahmen mattschwarz

BIKE/SPORTS EYEWEAR
›RAYON G4 PRO‹

- **polycarbonate** frame
- with **exchangeable, red Iridium coated** lenses
- with additional **anti-glare, orange** and **clear** spare lenses
- with **lateral wind protector**
- with **anatomic cheek shape**
- with **soft, adjustable** nose pads
- frame matt black



SIDE GUARD

ANTI REFLEX COATING

CHOPS RELIEVE



710160 FAHRRAD-/SPORTBRILLE
›RAYON ONE‹

34,90 €

- Rahmen aus **Polycarbonat**
- mit **blau Iridium beschichteten** Gläsern
- mit zusätzlichen **klaren, orangen** und **dunklen** Ersatzgläsern
- mit **weichen flexiblen** Nasenbügeln
- gummierte Brillenbügel
- Rahmen schwarz / grau

BIKE/SPORTS EYEWEAR
›RAYON ONE‹

- **polycarbonate** frame
- with **blue Iridium coated** lenses
- with additional **clear, orange** and **dark** spare lenses
- with **soft flexible** nose pads
- rubber temples
- frame black / grey



Sunglasses

ART.-NR. BESCHREIBUNG
UVP

DESCRIPTION

710162 FAHRRAD-/SPORTBRILLE

26,90 €



- ›RAYON G4‹**
- extrem guter Sonnenschutz durch **Iridium beschichtete Gläser** (austauschbar)
 - mit zusätzlichen **klaren, orangen, braunen** und **dunklen Ersatzgläsern**
 - **superleicht** und **extrem biegsam** durch **Grilamid-TR 90 Rahmen**
 - mit **weichen** Bügelendeinlagen
 - mit **weichen** Nasenbügeln
 - Rahmen mattschwarz

BIKE/SPORTS EYEWEAR

›RAYON G4‹

- perfect sun protection by exchangeable **iridium coated replacement lenses**
- with additional **clear, orange, brown** and **dark spare lenses**
- **super light** and **extremely flexible** thru **Grilamid-TR 90 arms**
- with **soft** temple tips
- with **soft** nose pads
- frame matt black



710163 FAHRRAD-/SPORTBRILLE

26,90 €



- ›RAYON IN-SIGHT‹**
- getönte Gläser **aufklappbar**
 - mit **herausnehmbarer Halterung für optische Sehhilfen**
 - mit **auswechselbaren, dunklen** Gläsern
 - mit zusätzlichen **klaren, orangen** und **braunen Ersatzgläsern**
 - mit **weichen** Bügelendeinlagen
 - mit **weichen** Nasenbügeln
 - Rahmen matt-dunkelanthrazit

BIKE/SPORTS EYEWEAR

›RAYON IN-SIGHT‹

- dark lenses **folding**
- with **removable frame for optical lenses**
- with **exchangeable, dark** lenses
- with additional **clear, orange** and **brown spare lenses**
- with **soft** temple tips
- with **soft** nose pads
- frame matt dark anthracite



FAHRRAD-/SPORTBRILLE

›RAYON FLEXI 4‹

- mit **auswechselbaren, dunklen** Gläsern
- mit **weichen** Nasenbügeln
- mit **weichen** Bügelendeinlagen

BIKE/SPORTS EYEWEAR

›RAYON FLEXI 4‹

- with **exchangeable** dark lenses
- with **soft** nose pads
- with **soft** temple tips



- 710161**
- Rahmen **matt-dunkelblau**
 - mit zusätzlichen **klaren, gelben, orangen** und **braunen Ersatzgläsern**
- 19,90 €

- frame **matt dark blue**
- with additional **clear, yellow, orange** and **brown spare lenses**

- 710167**
- Rahmen **mattschwarz**
 - mit zusätzlichen **klaren, orangen** und **braunen Ersatzgläsern**
- 17,90 €

- frame **matt black**
- with additional **clear, orange** and **brown spare lenses**



710171 FAHRRAD-/SPORTBRILLE

17,90 €



- ›RAYON F1‹**
- mit dunklen, **polarisierenden** Gläsern aus **Tri-Acetat Cellulose**
 - **mildert Blendeffekte**, Spiegelungen, Lichtreflexe
 - bessere **Wahrnehmung von Kontrasten und Farben**
 - **geringere Ermüdung** der Augen
 - mit **weichen** Bügelendeinlagen
 - Rahmen in dunkelgrau

BIKE/SPORTS EYEWEAR

›RAYON F1‹

- with dark, **polarised** glasses made of **Tri-Acetat Cellulose**
- **softens glare**, reflections, light reflections
- better **awareness of contrasts and colours**
- **less eye fatigue**
- with **soft** temple tips
- frame dark grey



ART.-NR. BESCHREIBUNG
UVP

DESCRIPTION

710168 FAHRRAD-/SPORTBRILLE

14,90 €

POLARISED LENSES

- ›RAYON FIT OVER ‹
- für Brillenträger, wird über optischen Brillen getragen
 - schwarzer Hochglanz-Rahmen
 - seitliche Belüftung
 - seitliches, getöntes Sichtfeld
 - mit dunklen, **polarisierenden** Gläsern aus **Tri-Acetat Cellulose**
 - **mildert Blendeffekte**, Spiegelungen, Lichtreflexe
 - bessere **Wahrnehmung von Kontrasten und Farben**
 - **geringere Ermüdung** der Augen

BIKE/SPORTS EYEWEAR

›RAYON FIT OVER ‹

- for spectacle wearers, to be worn over optical glasses
- black high polish frame
- lateral ventilation
- lateral tinted viewing area
- with dark, **polarised** lenses made of **Tri-Acetate Cellulose**
- **softens glare**, reflections, light reflections
- better **awareness of contrasts and colours**
- **less eye fatigue**



IRIDIUM COATED

KINDER-/FAHRRAD-/SPORTBRILLEN ›RAYON KIDS‹

- mit **weichen** Bügelendeinlagen

CHILDREN/BIKE/SPORTS EYEWEAR ›RAYON KIDS‹

- with **soft** temple tips



- 710165**
- Rahmen schwarz
 - dunkle Gläser

- frame black
- dark lenses

- 710166**
- Rahmen rot
 - Top-Sonnenschutz durch **iridiumbeschichtete** Gläser
- 12,90 €

- frame red
- top sun protection because of **iridium coated** lenses

Sunglasses



M-WAVE

YOUR WORLD OF CYCLING

www.m-wave-bike.com

ART.-NR. UVP **BESCHREIBUNG**

DESCRIPTION

Bezahlbare Sicherheit und ein attraktiver Look müssen keine Gegensätze sein. Unsere Helme sind ein exzellentes Beispiel hierfür.

Affordable security and an attractive look do not have to be opposites. Our Helmets are an excellent example here for.

Alle Helme sind gemäß EN-1078 geprüft und verfügen über ein CE-Zeichen. Sie gewährleisten höchste Sicherheit. Unser Sortiment deckt die unterschiedlichsten Einsatzbereiche ab. Alle unsere Helme sind in einer Box verpackt.

All helmets are in accordance with EN 1078 and have a CE sign. They guarantee highest safety. Our product range covers extensive areas of use. All helmets are packed in a box.

DOWNHILL HELM ›FALL OUT‹

Maximale Sicherheit ohne Kompromisse! Dies war die Vorgabe bei der Entwicklung des ›Fall Out‹ - Helms. Als Vollvisierhelm ist er für den harten Downhilleinsatz o.Ä. konzipiert. Die spezielle **Thermoplast-Hartschale** mit den **Metallgitterversteifungen** kann auch harte Einschläge wegstecken.

DOWNHILL HELMET ›FALL OUT‹

Maximum safety without compromise! This was the main premiss for the development of the ›Fall Out‹ helmet. As a full visor helmet it was designed for hardcore usage, like downhill riding or similar. The special **thermoplast hard shell** with **metal mesh reinforcements** can even absorb hard impacts.

[according to EN 1078](#)

Belüftung: 18 Öffnungen
 Gewicht: 870 g (M, mit Visier)
 Komfort: herausnehmbare, **waschbare** Comfort Pads
 Technologie: **Thermoplast Hartschale** mit **Metallgitterversteifung**
 Visier: abnehmbares Anschraubvisier

ventilation: 18 holes
 weight: 870 g (M, with visor)
 comfort: removable, **washable** comfort pad
 technology: **thermoplast hard shell** with **metal mesh reinforcement**
 visor: detachable screw-on visor



731298 Größe M, 53 - 56 cm (Jugend/**Kind**)

size M, 53 - 56 cm (youth/**kid**)

731299 Größe L, 57 - 61 cm (Erwachsene)

size L, 57 - 61 cm (adult)

123,00 €

DOWNHILL HELM ›ALL IN 1‹

Belüftung: 17 Öffnungen
 Gewicht: 650 - 710 g (M, mit Visier)
 Einstellsystem: **Kopfgröße anpassbar** durch 2 verschiedene Polyester-Sets
 Komfort: herausnehmbare, waschbare Comfort Pads
 Technologie: **ABS Hardshell, Integralhelm:** abnehmbarer Kinnschutz
 Visier: abnehmbares Anschraubvisier

DOWNHILL HELMET ›ALL IN 1‹

ventilation: 17 holes
 weight: 650 - 710 g (M, with visor)
 adjustment system: **adjustable to head size** by 2 different pads
 comfort: removable, washable comfort pads
 technology: **ABS hard shell, full face helmet:** detachable chin protector
 visor: detachable screw-on visor

[according to EN 1078](#)



731140 Größe M, 54 - 58 cm

size M, 54 - 58 cm

731141 Größe L, 58 - 61 cm

size L, 58 - 61 cm

61,90 €



ART.-NR. BESCHREIBUNG
UVP

DESCRIPTION



FAHRRADHELM ›URBAN‹

Unser **Multisport-** und **Commuter-**Helm der neuesten Generation. Die zurückhaltende Form mit nach hinten heruntergezogener Schale begeistert sowohl Pendler, BMX-Fahrer als auch Inline-Skater. Durch seine Belüftungsöffnungen hilft er, einen kühlen Kopf zu bewahren.

Belüftung: 16 Öffnungen
Gewicht: 400 g (M)
Einstellsystem: Ringsystem, mit Reflex
Komfort: herausnehmbare, waschbare Comfort Pads
Technologie: **ABS Hardshell**
Visier: integriert
Sicherheit: mit Reflex-Aufkleber

ohne Helmlicht

Design: **matt black**

- 731820** Größe M, 55 - 58 cm (Jugend)
- 731821** Größe L, 59 - 61 cm (Erwachsene)

Design: **matt white**

- 731822** Größe M, 55 - 58 cm (Jugend)
- 731823** Größe L, 59 - 61 cm (Erwachsene)

46,90 €

BICYCLE HELMET ›URBAN‹

according to EN 1078

Our latest generation of **multi sport** and **commuter** helmet. Commuters, BMX riders as well as inline skaters will love this reserved shape with tucked in shell on the back. It helps to keep cool through its numerous ventilation holes.

ventilation: 16 holes
weight: 400 g (M)
adjustment system: ring system, with reflex
comfort: removable, washable comfort pads
technology: **ABS hard shell**
visor: integrated
security: with reflex sticker

without helmet light

Design: **matt black**

- size M, 55 - 58 cm (youth)
- size L, 59 - 61 cm (adult)

Design: **matt white**

- size M, 55 - 58 cm (youth)
- size L, 59 - 61 cm (adult)



mit herausnehmbarem Helmlicht

- **6 rote LEDs**
- 3 Funktionen (Dauerlicht, 2x Blinklicht)
- inkl. Batterie (CR 2032)

Design: **matt black**

- 731824** Größe M, 55 - 58 cm (Jugend)
- 731825** Größe L, 59 - 61 cm (Erwachsene)

Design: **matt white**

- 731826** Größe M, 55 - 58 cm (Jugend)
- 731827** Größe L, 59 - 61 cm (Erwachsene)

52,90 €

with removable helmet light

- **6 red LEDs**
- 3 functions (steady light, 2x flashing light)
- incl. battery (CR 2032)

design: **matt black**

- size M, 55 - 58 cm (youth)
- size L, 59 - 61 cm (adult)

Design: **matt white**

- size M, 55 - 58 cm (youth)
- size L, 59 - 61 cm (adult)



ART.-NR. UVP **BESCHREIBUNG**

DESCRIPTION

FAHRRADHELM ›ACTIVE‹

Belüftung: 11 Öffnungen
 Gewicht: 235-265 g (M, mit Visier)
 Einstellsystem: **Ringsystem**, mit Reflex
 Komfort: herausnehmbare, waschbare Pads
 Technologie: **Microshell** Oberschale
 Visier: aufsteckbares Visier
 Sicherheit: Mückenschutz, Reflex-Aufkleber

BICYCLE HELMET ›ACTIVE‹

ventilation: 11 holes
 weight: 235-265 g (M, with visor)
 adjustment system: **ring system**, with reflex
 comfort: removable, washable comfort pads
 technology: **Microshell** face plate
 visor: stick-on visor
 security: mosquito net, reflex sticker

according to EN 1078



Design: **White Carbon**

design: **White Carbon**

- 733128** Größe M, 53 - 57 cm (Jugend)
- 733129** Größe L, 58 - 61 cm (Erwachsene)

- size M, 53 - 57 cm (youth)
- size L, 58 - 61 cm (adult)



Design: **Blue Spots**

design: **Blue Spots**

- 731027** Größe M, 53 - 57 cm (Jugend)
- 731028** Größe L, 58 - 61 cm (Erwachsene)

- size M, 53 - 57 cm (youth)
- size L, 58 - 61 cm (adult)



Design: **Mamba**

design: **Mamba**

- 731036** Größe M, 53 - 57 cm (Jugend)
- 731037** Größe L, 58 - 61 cm (Erwachsene)

- size M, 53 - 57 cm (youth)
- size L, 58 - 61 cm (adult)



Design: **red/black/white/silver**

design: **red/black/white/silver**

- 731034** Größe M, 53 - 57 cm (Jugend)
- 731035** Größe L, 58 - 61 cm (Erwachsene)

- size M, 53 - 57 cm (youth)
- size L, 58 - 61 cm (adult)



Design: **White Flower**

design: **White Flower**

- 731032** Größe M, 53 - 57 cm (Jugend)
- 731033** Größe L, 58 - 61 cm (Erwachsene)

- size M, 53 - 57 cm (youth)
- size L, 58 - 61 cm (adult)



28,90 €

BMX HELM ›LAUNCH‹

Belüftung: 11 Öffnungen
 Gewicht: 380 g (M)
 Einstellsystem: **Ringsystem**
 Komfort: herausnehmbare, waschbare Pads
 Technologie: **ABS Hardshell**

BMX HELMET ›LAUNCH‹

ventilation: 11 holes
 weight: 380 g (M)
 adjustment system: **ring system**
 comfort: removable, washable comfort pads
 technology: **ABS hard shell**

according to EN 1078



Design: **matt black**

design: **matt black**

- 731184** Größe M, 54 - 58 cm
- 731284** Größe L, 58 - 61 cm

- size M, 54 - 58 cm
- size L, 58 - 61 cm



Design: **black**

design: **black**

- 731182** Größe M, 54 - 58 cm
- 731282** Größe L, 58 - 61 cm

- size M, 54 - 58 cm
- size L, 58 - 61 cm



Design: **white**

design: **white**

- 731183** Größe M, 54 - 58 cm
- 731283** Größe L, 58 - 61 cm

- size M, 54 - 58 cm
- size L, 58 - 61 cm



Design: **matt green**

design: **matt green**

- 731475** Größe M, 54 - 58 cm
- 731485** Größe L, 58 - 61 cm

- size M, 54 - 58 cm
- size L, 58 - 61 cm



29,90 €

ART.-NR. BESCHREIBUNG
UVP

DESCRIPTION



KINDERHELM ›JUNIOR‹

Was ist das wichtigste an einem Kinderhelm? Ganz klar die **Sicherheit**. Damit aber der Tragekomfort nicht zu kurz kommt, haben unsere Kinderhelme **zahlreiche Einstellmöglichkeiten**. Und zur Freude der Eltern macht das Helmtragen mit unseren **attraktiven Designs** auch noch Spaß!

Belüftung: 12 Öffnungen
Gewicht: **213 g (XS)**
Einstellsystem: Ringsystem mit **Reflex**
Komfort: herausnehmbare, waschbare Comfort Pads, mit zusätzlichem Ersatz-Pad-Set
Technologie: **In-Mould** Microshell integriert
Visier: Mückenschutz, Reflex-Aufkleber

Design: **Zoo**
weiß

731880 Größe XS, 48 - 54 cm

731881 Größe S, 52 - 56 cm

Design: **Race**
schwarz / gelb

731882 Größe XS, 48 - 54 cm

731883 Größe S, 52 - 56 cm

Design: **Sweet**
pink

731884 Größe XS, 48 - 54 cm

731885 Größe S, 52 - 56 cm

29,90 €

CHILDREN HELMET ›JUNIOR‹

What's the most important thing about children's helmets? **Safety**, of course. However, our children's helmets have **numerous adjustment possibilities**, so that comfort is not sacrificed. Parents will see that wearing one of our **fashionable children's helmets** is safe and also fun!

ventilation: 12 holes
weight: **213 g (XS)**
adjustment system: ring system with **reflex**
comfort: removable, washable comfort pads, with additional replacement pad set
technology: **In-Mould** Microshell integrated
visor: mosquito net, reflex sticker

design: **Zoo**
white

size XS, 48 - 54 cm

size S, 52 - 56 cm

design: **Race**
black / yellow

size XS, 48 - 54 cm

size S, 52 - 56 cm

design: **Sweet**
pink

size XS, 48 - 54 cm

size S, 52 - 56 cm

according to EN 1078



REFLEX



KINDERHELM ›KID-X-S‹

Belüftung: 6 Öffnungen
Gewicht: 200 g (XS)
Einstellsystem: **Ringsystem**
Komfort: herausnehmbare, waschbare Pads
Technologie: **Microshell** Oberschale integriert
Visier: Mückenschutz
Sicherheit: **XS, 46 - 52 cm**

730231 Design: **Smile**
neongelb

734072 Design: **Teddy**
blau

734070 Design: **Frog**
rot
21,90 €

CHILDREN HELMET ›KID-X-S‹

ventilation: 6 holes
weight: 200 g (XS)
adjustment system: **ring system**
comfort: removable, washable comfort pads
technology: **Microshell** face plate integrated
visor: mosquito net
security: **XS, 46 - 52 cm**

design: **Smile**
neon yellow

design: **Teddy**
blue

design: **Frog**
red

according to EN 1078



RING SYSTEM



ART.-NR. UVP **BESCHREIBUNG**

DESCRIPTION



KINDERHELM ›KID-S‹

Belüftung: 6 Öffnungen
 Gewicht: 190 g (S)
 Einstellsystem: **Ringsystem**
 Komfort: herausnehmbare, waschbare Pads
 Technologie: **Microshell** Oberschale
 Visier: integriert
 Sicherheit: Mückenschutz
 Größe: **S, 52 - 57 cm**

CHILDREN HELMET ›KID-S‹

ventilation: 6 holes
 weight: 190 g (S)
 adjustment system: **ring system**
 comfort: removable, washable comfort pads
 technology: **Microshell** face plate
 visor: integrated
 security: mosquito net
 size: **S, 52 - 57 cm**

according to EN 1078

731125 Design: **Space**
 blau, mit **Reflexmaterial**
 20,90 €

design: **Space**
 blue, with **reflective material**



RING SYSTEM



REFLEX

REFLEX

730230 Design: **Smile**
 neongelb

design: **Smile**
 neon yellow



731004 Design: **Police**
 weiß/schwarz

design: **Police**
 white/black



731007 Design: **Soccer**
 blau

design: **Soccer**
 blue



734040 Design: **Little Devil**
 rot/gelb

design: **Little Devil**
 red/yellow



731123 Design: **Wizard**
 blau/violett/schwarz

design: **Wizard**
 blue/purple/black



731006 Design: **Curly**
 rosa

design: **Curly**
 rose



731000 Design: **Sea Land**
 blau

design: **Sea Land**
 blue



731076 Design: **Sea Land**
 gelb

design: **Sea Land**
 yellow



731001 Design: **Flower**
 pink
 19,90 €

design: **Flower**
 pink



ART.-NR. BESCHREIBUNG
UVP

DESCRIPTION

SKI

WINTER

SNOWBOARD

SKIHELM ›UNIVERSAL‹

Belüftung: 5 Öffnungen, von denen **2 verschließbar** sind
Gewicht: 475 - 505 g
Einstellsystem: **Ringsystem**
Komfort: warme, atmungsaktive **Innenpolsterung**, Kinnschutz
Technologie: **Hardshell** Oberschale aus **schlagfestem ABS-Kunststoff**
Extras: mit integriertem Skibrillenhalter, abnehmbarer Ohrenschutz

Design: **black**

733077 Größe S, 52 - 55 cm (Kinder)

733078 Größe M, 55 - 58 cm (Jugend)

733079 Größe L, 58 - 59,5 cm (Erwachsene)

Design: **white**

733034 Größe S, 52 - 55 cm (Kinder)

733035 Größe M, 55 - 58 cm (Jugend)

733036 Größe L, 58 - 59,5 cm (Erwachsene)

Design: **blue**

733004 Größe S, 52 - 55 cm (Kinder)

733005 Größe M, 55 - 58 cm (Jugend)

733006 Größe L, 58 - 59,5 cm (Erwachsene)
45,90 €

SKI HELMET ›UNIVERSAL‹

ventilation: 5 holes, **2** of them are **closable**
weight: 475 - 505 g
adjustment system: **ring system**
comfort: warm, breathable **inner padding**, chin protection
technology: **Hardshell** face plate made of **shock-resistant ABS special nylon**
extras: with integrated bracket for ski glasses, removeable ear protectors

design: **black**

size S, 52 - 55 cm (children)

size M, 55 - 58 cm (youth)

size L, 58 - 59.5 cm (adult)

design: **white**

size S, 52 - 55 cm (children)

size M, 55 - 58 cm (youth)

size L, 58 - 59.5 cm (adult)

design: **blue**

size S, 52 - 55 cm (children)

size M, 55 - 58 cm (youth)

size L, 58 - 59.5 cm (adult)





STAUB, SCHLAMM, SCHMUTZ?

Schütze dein Rad mit den Produkten der Pflegeserie GUARD. Die bereits seit 1991 speziell für Fahrräder entwickelten Pflegeprodukte haben sich weltweit bei professionellen Rennteams bewährt. Die hohe Qualität verlängert die Lebensdauer der Fahrradteile und sorgt für perfekten Leichtlauf.

- **Schmieren, Schützen, Entfetten – GUARD hat für alles die passende Lösung**
- **Produktion in der EU**
- **Höchste Qualität, die den Ansprüchen von Top-Athleten gerecht wird**

DUST, MUD, DIRT?

Protect your bike with products from the GUARD bike care series. These special care products for bikes have been developed since 1991 and are used by professional racing teams worldwide. Their high quality extends the life time of your bicycle parts and ensures smooth operation.

- **Lubrication, protection, degreasing – GUARD has the right solution**
- **Production within the EU**
- **High quality which meets the requirements of top athletes**

REINIGEN

CLEAN

FAHRRADREINIGER >CLEAN GUARD<

- besonders **reichhaltiger und gut haftender Schaum** zur intensiven Reinigung von starken Verschmutzungen wie Matsch, Fett und Öl
- leicht **biologisch abbaubar**
- sanft zu Lack und Oberfläche
- auch für Carbonrahmen geeignet
- Gebrauchsanweisung in BG, CS, DA, DE, EL, EN, ES, FI, FR, HR, HU, IT, NL, NO, PL, PT, RO, RU, SK, SL, SR, SV, TR, UA

880750 500 ml PE-Sprühflasche
7,90 €

880751 1000 ml Kanister zum Nachfüllen von Art. 880750
9,90 €

BIKE CLEANER >CLEAN GUARD<

- extra **rich and maintaining foam** for intensive cleaning from mud, grease and oil
- readily **biodegradable**
- sensitive to coating and surface
- also suitable for carbon frames
- instruction manual in BG, CS, DA, DE, EL, EN, ES, FI, FR, HR, HU, IT, NL, NO, PL, PT, RO, RU, SK, SL, SR, SV, TR, UA

500 ml PE spray bottle

1000 ml canister to refill art. 880750



880778 SCHEIBENBREMSENREINIGER >BRAKE GUARD<

8,90 €

- leistungsstarker **Spezialreiniger für Scheibenbremsen**
- **entfernt** schnell und vollkommen rückstandsfrei Bremsstaub sowie alle **öl-, fett- und silikonhaltigen Verschmutzungen**
- mit Punktsprühkopf für gezielten Strahl
- Gebrauchsanweisung in BG, CS, DA, DE, EL, EN, ES, FI, FR, HR, HU, IT, NL, NO, PL, PT, RO, RU, SK, SL, SR, SV, TR, UA
- 400 ml Sprühdose

DISC BRAKE CLEANER >BRAKE GUARD<

- high performance **special cleaner for disc brakes**
- **removes** quickly and entirely residue free brake dust, as well as **oil, grease and silicone soiling**
- with spray head for exact spraying
- instruction manual in BG, CS, DA, DE, EL, EN, ES, FI, FR, HR, HU, IT, NL, NO, PL, PT, RO, RU, SK, SL, SR, SV, TR, UA
- 400 ml spray tin



ART.-NR. BESCHREIBUNG
UVP

DESCRIPTION

SCHMIEREN

LUBRICATE

KETTENPFLEGE
›CHAIN GUARD ULTRA‹

- sehr **gute Haftfähigkeit**
- Verschleiß- und Korrosionsschutz
- bei **trockenen und nassen** Bedingungen verwendbar
- Gebrauchsanweisung in BG, CS, DA, DE, EL, EN, ES, FI, FR, HR, HU, IT, NL, NO, PL, PT, RO, RU, SK, SL, SR, SV, TR, UA

880765 50 ml PE-Flasche
5,90 €

880766 200 ml Sprühdose, mit Punktsprühkopf für gezielten Strahl
10,90 €

CHAIN CARE
›CHAIN GUARD ULTRA‹

- very **good adhesion**
- wear and corrosion protection
- to be used on **dry and wet** conditions
- instruction manual in BG, CS, DA, DE, EL, EN, ES, FI, FR, HR, HU, IT, NL, NO, PL, PT, RO, RU, SK, SL, SR, SV, TR, UA

50 ml PE bottle

200 ml spray tin, with spray head for exact spraying

2 IN 1: DRY AND WET



SPEZIALÖL
›OIL GUARD BIODEGRADABLE‹

- **Universalöl** für alle beweglichen Teile am Fahrrad
- **gute Kriechwirkung** und Korrosionsschutz
- besonders geeignet für Seilzüge, Schaltwerke, ...
- leicht **biologisch abbaubar**
- Gebrauchsanweisung in BG, CS, DA, DE, EL, EN, ES, FI, FR, HR, HU, IT, NL, NO, PL, PT, RO, RU, SK, SL, SR, SV, TR, UA

880760 100 ml PE-Flasche
4,90 €

880761 200 ml Sprühdose
• mit Punktsprühkopf für gezielten Strahl
7,90 €

SPECIAL OIL
›OIL GUARD BIODEGRADABLE‹

- **universal oil** for all movable parts of the bicycle
- **good creep effect** and corrosion protection
- especially suitable for cables, derailleurs, ...
- readily **biodegradable**
- instruction manual in BG, CS, DA, DE, EL, EN, ES, FI, FR, HR, HU, IT, NL, NO, PL, PT, RO, RU, SK, SL, SR, SV, TR, UA

100 ml PE bottle

200 ml spray tin
• with spray head for exact spraying



880779 SCHMIERMITTEL
›LUBE GUARD WHITE‹

6,90 €

- sehr **hochwertiges**, weißes **PTFE-Schmierfett**
- zum Schmieren von Lagern, Naben, Pedalen, ...
- schützt vor eindringendem Wasser und **verlängert die Lebensdauer** von Lagern
- Gebrauchsanweisung in BG, CS, DA, DE, EL, EN, ES, FI, FR, HR, HU, IT, NL, NO, PL, PT, RO, RU, SK, SL, SR, SV, TR, UA
- 125 ml Dose

LUBRICANT
›LUBE GUARD WHITE‹

- **high-quality**, white **PTFE lubricant**
- for the lubrication of bearings, hubs, pedals, ...
- excels in its high resistance against water and **provides a long life** for all bearings
- instruction manual in BG, CS, DA, DE, EL, EN, ES, FI, FR, HR, HU, IT, NL, NO, PL, PT, RO, RU, SK, SL, SR, SV, TR, UA
- 125 ml can



MONTIEREN

MOUNTING

880780 CARBON MONTAGEPASTE
›GREASE GUARD DIAMOND‹

14,90 €

- für Carbonteile
- auch geeignet für Stahl, Aluminium oder Titanteile in Kombination mit Carbon
- verhindert Verrutschen
- **niedrigere Klemmkräfte** (Drehmoment) reichen für gute Verbindung
- **leichteres Lösen** der Verbindung möglich
- Gebrauchsanweisung in DE, EN, ES, FR, NL
- 125 ml Dose

CARBON GRIP PASTE
›GREASE GUARD DIAMOND‹

- for carbon parts
- also suitable for steel, aluminium or titanium parts in combination with carbon
- prevents slipping
- **low clamping force** (torque) is enough for good connection
- connection **easily resolvable**
- instruction manual in DE, EN, ES, FR, NL
- 125 ml can



ART.-NR. BESCHREIBUNG
UVP

DESCRIPTION

SCHUTZ UND KONSERVIERUNG

PROTECTION AND CONSERVATION

880770 SPRÜHWACHS ›WAX GUARD‹

- 6,90 €
- erneuert und **schützt Oberflächen**
- frischt die Farbe auf und begrenzt die Schmutzablagerung
- verlängert die Lebensdauer
- universell einsetzbar für Metall, Carbon, Gummi, Glattleder, Synthetik ...
- Gebrauchsanweisung in BG, CS, DA, DE, EL, EN, ES, FI, FR, HR, HU, IT, NL, NO, PL, PT, RO, RU, SK, SL, SR, SV, TR, UA
- 200 ml Sprühdose

SPRAY WAX ›WAX GUARD‹

- renews and **protects surfaces**
- refreshes colours and limits deposition of dirt
- increases lifetime
- for metal, carbon, rubber, smooth leather, synthetic ...
- instruction manual in BG, CS, DA, DE, EL, EN, ES, FI, FR, HR, HU, IT, NL, NO, PL, PT, RO, RU, SK, SL, SR, SV, TR, UA
- 200 ml spray tin



880775 SILIKONSPRAY ›SILICONE GUARD‹

- 9,90 €
- **schmiert, pflegt und konserviert Kontaktflächen von Kunststoff, Gummi und Metall**
- beseitigt Knarr- und Quietschgeräusche
- besonders für **Federgabeln** geeignet
- mit Punktsprühkopf für gezielten Strahl
- Gebrauchsanweisung in BG, CS, DA, DE, EL, EN, ES, FI, FR, HR, HU, IT, NL, NO, PL, PT, RO, RU, SK, SL, SR, SV, TR, UA
- 400 ml Sprühdose

SILICONE SPRAY ›SILICONE GUARD‹

- **lubricates, maintains and conserves contact surfaces of plastic, rubber and metal**
- removes creaking and squeaking noises
- especially for **suspension forks**
- with spray head for exact spraying
- instruction manual in BG, CS, DA, DE, EL, EN, ES, FI, FR, HR, HU, IT, NL, NO, PL, PT, RO, RU, SK, SL, SR, SV, TR, UA
- 400 ml spray tin



PFLEGESET

CARE SET

880785 FAHRRAD PFLEGESET ›GUARD TEAM‹

- 26,90 €
- bestehend aus:
 - Fahrradreiniger ›Clean Guard‹** (Art. 880750)
 - Sprühwachs ›Wax Guard‹** (Art. 880770)
 - Kettenpflege ›Chain Guard Ultra‹** (Art. 880765)
 - Spezialöl ›Oil Guard Bio‹** (Art. 880760)
- Gebrauchsanweisung in BG, CS, DA, DE, EL, EN, ES, FI, FR, HR, HU, IT, NL, NO, PL, PT, RO, RU, SK, SL, SR, SV, TR, UA
- in M-Wave Eurolochbox

BICYCLE CARE SET ›GUARD TEAM‹

- consisting of:
 - Bike cleaner ›Clean Guard‹** (art. 880750)
 - Spray wax ›Wax Guard‹** (art. 880770)
 - Chain care ›Chain Guard Ultra‹** (art. 880765)
 - Special oil ›Oil Guard Bio‹** (art. 880760)
- instruction manual in BG, CS, DA, DE, EL, EN, ES, FI, FR, HR, HU, IT, NL, NO, PL, PT, RO, RU, SK, SL, SR, SV, TR, UA
- in M-Wave eurohole box



Bicycle Care

ART.-NR. UVP	BESCHREIBUNG	DESCRIPTION	
880595 16,90 €	FETTSPRITZE ›GREASE GUN‹ <ul style="list-style-type: none"> ergonomische Form Aluminiumkörper durchsichtiges Rohr zur Funktionskontrolle mit einer Hand zu bedienen passend für Art. 880086, ... auf M-Wave Eurolochkarte 	GREASE GUN ›GREASE GUN‹ <ul style="list-style-type: none"> ergonomic shape aluminium body clear tube for function control easy one-hand operation suitable for art. 880086, ... on M-Wave eurohole card 	
880480 125,00 €	STEUERSATZWERKZEUGE <ul style="list-style-type: none"> Montagewerkzeug für perfekten Sitz der Lagerschalen im Rahmen aus gehärtetem Spezialstahl verwendbar von 1" bis 1¼" auch passend für 1" bis 1½" im Polybeutel 	HEAD SET TOOLS <ul style="list-style-type: none"> assembly tool for perfect fit of the ahead set cups in the frame special hardened steel useable from 1" to 1¼" also suitable for 1" to 1½" in PE bag 	
880223 35,90 €	<ul style="list-style-type: none"> Werkzeug zum Einschlagen des Gabelkonus passend für 1" und 1½" im Polybeutel 	<ul style="list-style-type: none"> head set cone mounting tool suitable for 1" and 1½" in PE bag 	
880481 19,90 €	<ul style="list-style-type: none"> Steuersatz-Lagerschalen-Austreiber aus Rahmen passend für 1" und 1½" im Polybeutel 	<ul style="list-style-type: none"> head set cup remover from the frame suitable for 1" and 1½" in PE bag 	
881023 16,90 €	AHEAD-KRALLEN-EINSCHLAGHILFE ›TW-F1‹ <ul style="list-style-type: none"> einfaches und gerades Einschlagen der Kralle bei Aheadsystemen in 1⅞" Gabelschäfte im Polybeutel mit M-Wave-Eurolochheader 	AHEAD CLAW MOUNTING TOOL ›TW-F1‹ <ul style="list-style-type: none"> easy and accurate mounting of the Ahead claw in 1⅞" fork steerers in PE bag with M-Wave eurohole header 	
880482 27,90 €	ROHRABSCHNEIDEHILFE <ul style="list-style-type: none"> Rohrklemme mit Sägeführung zum Einspannen in einen Schraubstock Gabelschäfte, Sattelstützen, Lenker, ... können präzise mit einer Eisensäge gekürzt werden für Rohrdurchmesser 21 - 34 mm im Polybeutel 	TUBE CUTTING TRACK <ul style="list-style-type: none"> tube clamp with saw guide for fixing in a bench vice steerers, seat posts, handlebars, ... can be shortened precisely with a hacksaw for tube diameters from 21 - 34 mm in PE bag 	

ART.-NR. BESCHREIBUNG
UVP

DESCRIPTION

INNENLAGER WERKZEUG

BOTTOM BRACKET TOOL

881013

›BB Press In‹

›BB Press In‹

37,90 €

• für die einfache und **genaue Montage von Pressfit Innenlagern** (BB30, BB86, BB92)

• for easy and **accurate mounting of pressfit bottom brackets** (BB30, BB86, BB92)

3 IN 1

- **universell passend** für Lagerinnendurchmesser 30 mm, 24 mm (Shimano) und 24/22 mm (Sram/Truvativ GXP) über zusätzlichen Adapterring
- mit M-Wave Banderole

- **universally suitable** for inner bearing diameter 30 mm, 24 mm (Shimano) and 24/22 mm (Sram/Truvativ GXP) by additional adapter ring
- with M-Wave banderole



881009

›BB Screw 1‹

›BB Screw 1‹

13,90 €

- für **außenliegende Kugellagerschalen**
- passend für 12-kerbige außenliegende Lagerschalen (z.B. **Sram Dub** BSA / Rotor BSA30 / RaceFace Cinch / Zipp Vuma, Hawk Racing BB3086, ...)
- im Polybeutel mit Barcode-Aufkleber

- for **outer bearing cups**
- suitable for 12 notches external BB (e.g. **Sram Dub** BSA / Rotor BSA30 / RaceFace Cinch / Zipp Vuma, Hawk Racing BB3086, ...)
- in PE bag with barcode sticker



881003

- für außenliegende Kugellagerschalen
- passend für Shimano, Truvativ, Race Face, Campagnolo
- für 1/2" Steckverbindung

- for outer bearing shells
- suitable for Shimano, Truvativ, Race Face, Campagnolo
- for 1/2" connector



881001

- für Shimano Innenlager (kein Original Shimano Ersatzteil)
- für 1/2" Steckverbindung und 24 mm Schlüssel
- auf M-Wave Eurolochkarte

- for Shimano bottom bracket (no original Shimano spare part)
- for 1/2" connector and 24 mm wrench
- on M-Wave eurohole card

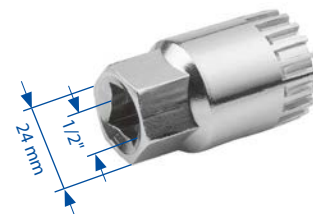

880456

E-MOTOR VERSCHLUSSRING WERKZEUG ›BB SCREW 2‹

E-MOTOR LOCKRING TOOL ›BB SCREW 2‹

22,90 €

2 IN 1

- für **Montage und Demontage des Verschlussrings** des Spiders/Kettenblatts
- aus stabilem, wärmebehandeltem Stahl
- 2 in 1:
 1. Bosch Classic Line (1. Generation)
 2. Active Line (2. Generation), Performance Line, Performance Line CX
- mit M-Wave Karte

- to **mount and demount the lockring** of the spider/chainring
- made of stable, heat-treated steel
- 2 in 1:
 1. Bosch Classic Line (1. Generation)
 2. Active Line (2. Generation), Performance Line, Performance Line CX
- with M-Wave tag



3 IN 1

KURBELABZIEHER

CRANKSET REMOVER

3 in 1, für **Shimano Octalink, ISIS** und **Vierkant**-Achsen

3 in 1, for **Shimano Octalink, ISIS** and **square** axles

880555

auf M-Wave Eurolochkarte

on M-Wave eurohole card



880547

im Polybeutel

in PE bag

6,90 €

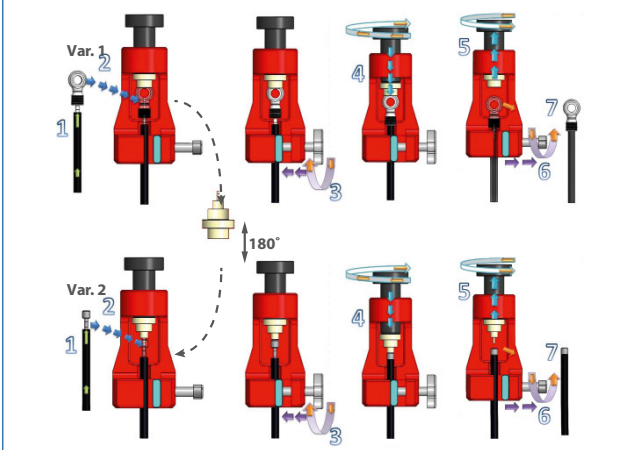
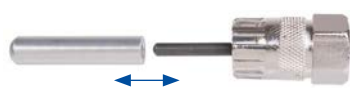
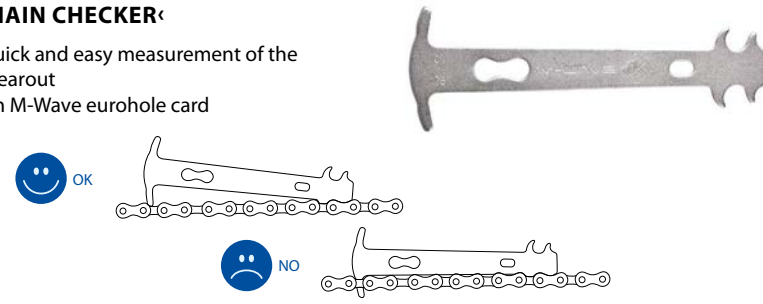
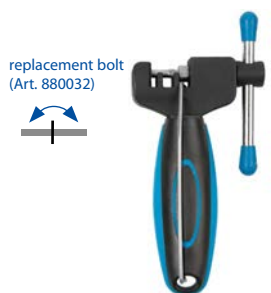
ART.-NR. UVP	BESCHREIBUNG	DESCRIPTION
881085 44,90 €	PRESSE FÜR HYDRAULIK-LEITUNGEN ›PRESS IT‹ <ul style="list-style-type: none"> • CNC-gefräste Montagehilfe • zum einfachen und geraden Einpressen von Leitungsverbindungen • drehbarer Leitungsadapter, passend für Shimano, Magura, Hayes, Tektro, Promax, etc. • auf M-Wave Eurolochkarte 	HYDRAULIC PRESS ›PRESS IT‹ <ul style="list-style-type: none"> • CNC machined installation aid • for easy and straight pressfitting of hydraulic line connections • turnable adapter, for Shimano, Magura, Hayes, Tektro, Promax, etc. • on M-Wave eurohole card
		
		
880458 5,90 €	KASSETTENZAHNKRANZ-WERKZEUG ›TW-D1‹ <ul style="list-style-type: none"> • mit 5 mm Führungsstift für Schnellspannachsen • abnehmbarer Adapter für Naben mit 12 mm Steckachse • für Shimano Hyperglide-Kassette • für Sram XD Drive • zur (De-)Montage von Shimano Centerlock Bremscheiben (QR9) (kein Original Shimano/Sram Ersatzteil) • für 1/2" Steckverbindung oder 24 mm Schlüssel • im Polybeutel mit M-Wave Euroloch-header 	CASSETTE SPROCKET REMOVER ›TW-D1‹ <ul style="list-style-type: none"> • with 5 mm guide pin for quick release axles • removable adapter for hubs with 12 mm thru axle • for Shimano hyperglide cassette • für Sram XD Drive • for (dis-)mounting of Shimano centerlock discs (QR9) (no original Shimano/Sram spare part) • for 1/2" drive or 24 mm wrench • in PE bag with M-Wave eurohole header
		
880446 3,90 €	KETTENMESSLEHRE ›CHAIN CHECKER‹ <ul style="list-style-type: none"> • schnelles und einfaches Messen des Verschleißes • auf M-Wave Eurolochkarte 	CHAIN CHECKER ›CHAIN CHECKER‹ <ul style="list-style-type: none"> • quick and easy measurement of the wearout • on M-Wave eurohole card
		
880031 9,90 €	KETTENNIETDRÜCKER ›PIN PUSHER PAUL‹ <ul style="list-style-type: none"> • hochwertige Ausführung • kunststoffummantelter Non-Slip Griff • mit Kettenhalter zur einfacheren Montage • Ersatzstift durch drehbaren Nietstift • Ersatzstift (Art. 880032) separat erhältlich • auf M-Wave Eurolochkarte 	CHAIN RIVETING TOOL ›PIN PUSHER PAUL‹ <ul style="list-style-type: none"> • high quality • plastic coated non-slip handle • with chain keeper for easier mounting • replacement bolt by turnable riveting bolt • replacement bolt (art. 880032) separately available • on M-Wave eurohole card
		

ART.-NR. BESCHREIBUNG
UVP

DESCRIPTION

880358 NIPPELDREHER-BIT

- 4,90 €
- Schlitznippeldreher-Bit mit Pin für **Elektroschrauber**
 - ermöglicht ein **superschnelles und einfaches Ein-/Aussteichen**
 - aus stabilem Carbonstahl, verchromt
 - Montageverpackung

SPOKE WRENCH BIT

- slit nipple wrench bit with pin **for electric screwdriver**
- provides **extremely fast and easy wheel set manufacturing**
- made of solid carbon steel, c.p.
- OEM

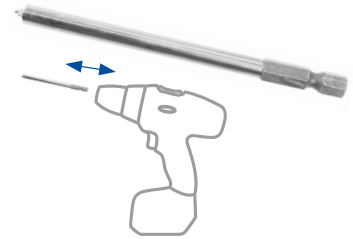

880266 DIGITALER DREHMOMENT-SCHLÜSSEL ›TORQUE ALARM◀

259,00 €

- **sehr hochwertige** Ausführung
- genaue Einteilung von **3 - 60 Nm**
- **2 % Genauigkeit**
- verschiedene Messeinheiten einstellbar
- mit **Signalton** beim Erreichen des eingestellten Drehmoments
- **umschaltbare** Knarre (3/8") mit **Richtungswechsel**
- **Drehmomentauslösung in beide Richtungen**
- 3/8" Adapter für Bits
- Bits mit 3/4/5/6/8/10 mm Innensechskant
- T 25, T 30 und T 40 Vielzahnschlüssel
- Kreuzschraubendreher
- 8/9/10/11/12/13/14/15 mm Nüsse
- inkl. Batterie (1 x AAA)
- im Hardcase mit M-Wave Banderole

DIGITAL TORQUE WRENCH ›TORQUE ALARM◀

- **very high quality**
- exact scale from **3 - 60 Nm**
- **2 % accuracy**
- various measure units adjustable
- with **acoustic signal** by achievement of the adjusted torque
- **reversible ratchet** (3/8") with **changeable direction**
- **torque release in both directions**
- 3/8" adapter for bits
- hex bits 3/4/5/6/8/10 mm allen key
- T 25, T 30 and T 40 star screwdriver
- Phillips screwdriver
- 8/9/10/11/12/13/14/15 mm nuts
- incl. battery (1 x AAA)
- in hardcase with M-Wave banderole



880291 DREHMOMENTSCHLÜSSEL ›TW-4/24◀

83,90 €

- **hochwertige** Ausführung
- genaue Einteilung von **4 - 24 Nm**
- Einstellung **fixierbar**
- **umschaltbare** Knarre (1/4") mit **Richtungswechsel**
- Bits mit 3/4/5/6/8 mm Innensechskant, T 25 und T 10 Vielzahnschlüssel
- mit **anatomisch geformtem 2-Komponenten Griff**
- im Hardcase mit M-Wave Banderole

TORQUE WRENCH ›TW-4/24◀

- **high quality**
- exact scale from **4 - 24 Nm**
- torque value **fixable**
- **reversible ratchet** (1/4") with **changeable direction**
- hex bits 3/4/5/6/8 mm allen key, T 25 and T 10 star screwdriver
- with **anatomically shaped 2 components grip**
- in hardcase with M-Wave banderole



880293 DREHMOMENTSCHLÜSSEL ›TW-3/10◀

15,90 €

- **3 - 10 Nm**
- Bits mit 3/4/5/6 mm Innensechskant, T 25 Vielzahnschlüssel, Kreuzschraubendreher
- in M-Wave Blisterverpackung

TORQUE WRENCH ›TW-3/10◀

- **3 - 10 Nm**
- hex bits 3/4/5/6 mm allen key, T 25 star screwdriver, Phillips screwdriver
- in M-Wave blister packaging



ART.-NR. UVP	BESCHREIBUNG	DESCRIPTION
-----------------	--------------	-------------

880264 BIT-SET ›ADAPT 1/4‹
6,90 €

- mit **Adapter von 1/4" Vierkant auf 1/4" Sechskant**
Dadurch können Sie **alle gängigen 1/4" Sechskantbits mit unserem Drehmomentschlüssel verwenden.**
- Bits mit 2,5/3/4/5/6 mm Innen-sechskant
- T 10/20/25 Vielzahnschlüssel
- Kreuzschraubendreher 1/2
- in M-Wave Eurolochbox

BIT SET ›ADAPT 1/4‹

- with **adapter from 1/4" square to 1/4" hex**
This allows you to **use all current 1/4" hex bits with our torque wrench.**
- hex bits 2.5/3/4/5/6 mm allen key
- T 10/20/25 star screwdriver
- Phillips screwdriver 1/2
- in M-Wave eurohole box



880267 REIFENFLICK-SET ›TUBELESS FIX‹
15,90 €

- in hochwertigem **Aluminium** Gehäuse
- 2 Funktionen: Reifen Reibahle und Einführwerkzeug
- verschieden dicke Streifen für kleine und große Löcher:
5 x Ø 1,5 mm
3 x Ø 3,5 mm
- Gehäuse dient bei Verwendung als Hebel
- auf M-Wave Eurolochkarte

TUBELESS REPAIR KIT ›TUBELESS FIX‹

- in high quality **aluminium** case
- 2 functions: tire reamer and insert tool
- stripes in different widths for small and big holes:
5 x Ø 1.5 mm
3 x Ø 3.5 mm
- case useable as lever
- on M-Wave eurohole card



880365 TUBELESS REPAIR KIT ›TUBELESS FIX ECO‹
8,90 €

- mit Reibahle und Einführungs-werkzeug
- verschieden dicke Streifen für kleine und große Löcher
5 x Ø 1,5 mm
5 x Ø 3,5 mm
- in M-Wave Kunststoff-Box

TUBELESS REPAIR KIT ›TUBELESS FIX ECO‹

- tire reamer and insert tool
- stripes in different widths for small and big holes
5 x Ø 1,5 mm
5 x Ø 3,5 mm
- in M-Wave plastic box



880368 REPARATURSET ›SMART REPAIR‹
2,90 € / set

in Kunststoff-Box, bestehend aus:

- 2 Reifenheber**
- 1 Tube Vulkanisierlösung (10 ml / 6,5 g)
- 2 Flicker Ø 26 mm
- 4 Flicker 25 x 34 mm
- 1 Flicker 34 x 51 mm
- 1 Sandpapier
- 1 Ventilschlauch
- Arbeitsanleitung

REPAIR SET ›SMART REPAIR‹

set in a box, consisting of:

- 2 tire levers**
- 1 tube solution (10 ml / 6.5 g)
- 2 patches Ø 26 mm
- 4 patches 25 x 34 mm
- 1 patch 34 x 51 mm
- 1 sand paper
- 1 valve tube
- instruction



880002 REIFENMONTIERZANGE
11,90 €

- Montagehilfe**, besonders geeignet für schwierige Reifen-/Felgen-Kombinationen
- besonders effektiv durch große **Hebelwirkung**
- aus hochwertigem Kunststoff
- auf M-Wave Eurolochkarte

WHEEL MOUNT PLIERS

- installation aid**, particularly suitable for complex tire to wheel combinations
- particularly effective with great **leverage**
- made of high quality plastic
- on M-Wave eurohole card



ART.-NR. BESCHREIBUNG
UVP

DESCRIPTION

880390 REIFENHEBER ›LEVER PRO‹

5,90 € / pair

- **hochwertiger** Kunststoff: **stabil** und **schonend**
- **extra lange** Ausführung
- fast **unzerbrechlich**
- paarweise auf M-Wave Eurolochkarte

TIRE LEVERS ›LEVER PRO‹

- **high quality** plastic: **stable** and **gentle**
- **extra long** version
- almost **unbreakable**
- one pair on M-Wave eurohole card



880262 REIFENHEBER ›TP-L1‹

2,90 € / set

- aus stabilem Kunststoff
- 1 Set = **3 Stück**
- mit **2-fach Haken** zum Einhängen in die Speichen
- auf M-Wave Eurolochkarte

TIRE LEVER ›TP-L1‹

- made of stable plastic
- 1 set = **3 pieces**
- with **double hook** for fixation at the spokes
- on M-Wave eurohole card



880253 GEWINDESCHNEIDE-SET ›CUT 10‹

62,90 €

10-teilig

- M 4 x 0,70
- M 5 x 0,80
- M 6 x 1,00
- M 8 x 1,25
- M 10 x 1,00
- Pedalgewindeschneider 9/16" (links & rechts)
- Pedalgewindeschneider 1/2" (links & rechts)
- inkl. Windeisen
- in Tasche mit M-Wave Banderole

THREAD CUTTING SET ›CUT 10‹

10-piece

- M 4 x 0.70
- M 5 x 0.80
- M 6 x 1.00
- M 8 x 1.25
- M 10 x 1.00
- pedal thread cutter 9/16" (left & right)
- pedal thread cutter 1/2" (left & right)
- incl. turning bracket
- in bag with M-Wave banderole



880050 FAHRRAD-WERKZEUGKOFFER ›PORTABLE CLINIC‹

129,00 €

"alles in einem", 43-teilig

- Flickzeug
- 2 Flach- und 2 Kreuzschraubenzieher
- Zahnkranzabzieher
- kleiner Schraubenzieher (für die Schaltungseinstellung)
- Gabelschlüssel 8/10 mm
- Zahnkranzschlüssel mit Kette
- Steuersatzschlüssel 30/32 + 36/40 mm
- Konusschlüssel 13/15 + 14/16 mm
- Kurbelabzieher
- Nippelspanner 10/11/12/13/14/15G
- Innensechskant-Schlüsselset 2/2,5/3/4/5/6 mm (bei 4/5/6 mm Innensechskant-Kugellende)
- verstellbarer Tretlagerschlüssel
- Pedalarmschlüssel 15/16 + 15/17 mm
- Tretlagerwerkzeug
- verstellbarer Gabelschlüssel, 0 - 21 mm
- Kettennietdrücker
- 8 mm Innensechskantschlüssel (für Kurbelabzieher)
- 3 Reifenheber
- 6/8/9/10 mm Sechskant
- mit M-Wave Banderole

BICYCLE TOOL CASE ›PORTABLE CLINIC‹

"all in one", 43 pcs.

- repair kit
- 2 flat and 2 Phillips screwdriver
- freewheel remover
- small screwdriver (for derailleur adjustment)
- forged open-ended wrench 8/10 mm
- freewheel turner with chain whip
- headset wrench 30/32 + 36/40 mm
- cone wrenches 13/15 + 14/16 mm
- cotterless crankarm extractor
- spoke adjuster 10/11/12/13/14/15G
- allen key set 2/2.5/3/4/5/6 mm (at 4/5/6 mm ball end)
- adjustable bottom bracket tool
- pedal wrench 15/16 + 15/17 mm
- cartridge bottom bracket tool
- adjustable forged steel wrench, 0 - 21 mm
- chain riveting tool
- 8 mm allen key wrench (for crankarm removal)
- 3 tire levers
- 6/8/9/10 mm hexagonal
- with M-Wave banderole



ART.-NR. UVP	BESCHREIBUNG	DESCRIPTION	
880920 22,90 €	MINI-FALTWERKZEUG ›LITTLE 15‹ 15 Funktionen <ul style="list-style-type: none"> • 2/2,5/3/4/5/6/8 mm Innensechskantschlüssel • Kreuz- und Schlitzschraubendreher • Kettennietdrücker • Speichenschlüssel 3,2/3,3/3,5/4 • T 25 Vielzahnschlüssel • auf M-Wave Eurolochkarte 	MINI FOLDING TOOL ›LITTLE 15‹ 15 functions <ul style="list-style-type: none"> • 2/2.5/3/4/5/6/8 mm allen key • Phillips and flat type screwdriver • chain riveting tool • spoke adjuster 3.2/3.3/3.5/4 • T 25 star screwdriver • on M-Wave eurohole card 	 <div style="position: absolute; top: 100px; left: 650px; border: 1px solid black; padding: 2px;"> <p style="font-size: 8px;">aktiv Rad fahren</p> <p style="font-size: 8px; background-color: black; color: white; padding: 2px;">PREIS/LEISTUNG</p> <p style="font-size: 8px;">5/2019</p> </div>

880955 14,90 €	MINI-FALTWERKZEUG ›LITTLE 12‹ 12 Funktionen Werkzeuge aus Chrom-Vanadium-Stahl <ul style="list-style-type: none"> • 2/3/4/5/6 mm Innensechskant • T 25 Vielzahnschlüssel • 2 Schraubenzieher • 4 Nippelspanner • nur 78 g • auf M-Wave Eurolochkarte 	MINI FOLDING TOOL ›LITTLE 12‹ 12 functions Tools made of chrome vanadium steel <ul style="list-style-type: none"> • 2/3/4/5/6 mm allen key • T 25 star screwdriver • 2 screwdrivers • 4 spoke adjusters • only 78 g • on M-Wave eurohole card 	
-------------------	---	--	--

408231 18,90 €	LENKERZUSATZGRIFF ›BE TOOL‹ <ul style="list-style-type: none"> • Aluminium • mattschwarz • Werkzeugset im Inneren mit 15 Funktionen: 4/5/6/8 mm Innensechskantschlüssel T 25 Vielzahnschlüssel 14G/0,136" Speichenschlüssel Kreuz-/Schlitzschraubendreher 8/9/10 mm Ring-/Maulschlüssel Kettennietdrücker 2 Reifenheber • in M-Wave Blisterverpackung 	BAR END ›BE TOOL‹ <ul style="list-style-type: none"> • aluminium • matt black • tool set inside with 15 functions: 4/5/6/8 mm allen key T 25 star screwdriver 14G/0.136" spoke wrench Phillips/flat screwdriver 8/9/10 mm round wrench chain riveting tool 2 tire levers • in M-Wave blister packaging 	<div style="text-align: right; font-size: 8px;">according to ISO 4210</div> 
-------------------	--	--	---

880941 7,90 €	MINI-FALTWERKZEUG ›MINI 7‹ <ul style="list-style-type: none"> • Carbon-Seitenteile • 2/3/4/5/6 mm Innensechskant • 1 Schlitzschraubendreher • 1 Kreuzschraubendreher • nur 59 g • inkl. Tasche mit Gürtelschlaufe • auf M-Wave Eurolochkarte 	MINI FOLDING TOOL ›MINI 7‹ <ul style="list-style-type: none"> • Carbon sides • 2/3/4/5/6 mm allen key • 1 flat screwdriver • 1 Phillips screwdriver • only 59 g • incl. pocket with belt loop • on M-Wave eurohole card 	
------------------	--	---	---



ART.-NR. BESCHREIBUNG
UVP

DESCRIPTION

880069 ZENTRIERSTÄNDER

146,00 €

FOLD

- für 12"-29" Laufräder
- **selbsttätiges Mittigstellen** beim Einspannen des Laufrades
- simultane Kontrolle des **Höhen- und Seitenschlages** möglich
- **Aluminium/Stahl**
- **zusammenklappbar**
- hochwertige Verarbeitung

WHEEL TRUING STAND

- for 12"-29" wheels
- clamps the wheel **centric** by **self-acting**
- simultaneous control of the **height and side tolerances** possible
- **aluminium/steel**
- **foldable**
- high-grade manufacturing



881041 MONTAGESTÄNDER
TOP ASSIST 2<

334,90 €

E-BIKES UP TO 50 KG

360°

- **Aluminium**
- mit **Aluminium Drehkopfverzahnung**
- nur 4,8 kg
- in Sekunden zusammenleg- und aufbaubar
- max. Belastung: **50 kg**
- **Klemme 360° drehbar**
- universell auf Rohrdurchmesser einstellbar
- **höhenverstellbar**
- **stabiler** Stand
- im M-Wave Einzelkarton

BICYCLE REPAIR STAND
TOP ASSIST 2<

- **aluminium**
- with **aluminium turning head interlock**
- only 4.8 kg
- foldable and defoldable in seconds
- max. load: **50 kg**
- **clamp 360° turnable**
- universally adjustable to tube diameter
- **height adjustable**
- **stable** stand
- in M-Wave box

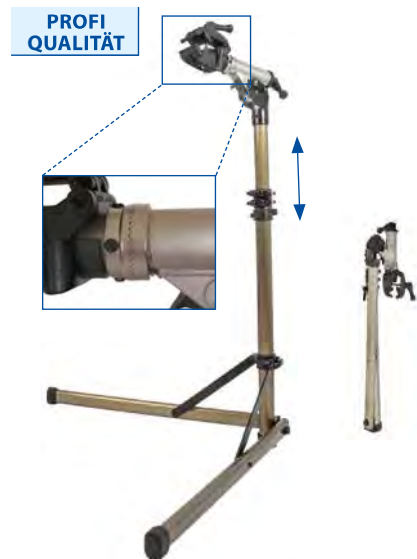

881042 ERSATZEINSAZ FÜR KLEMME

9,90 € / set

- für Montageständer Art. 881041, ...
- 2 Klemmeinsätze mit Befestigungsclips
- Set im Polybeutel

REPLACEMENT CLAMP INSERT

- for assembly stand art. 881041, ...
- 2 clamp inserts with mounting clips
- set in PE bag



881047 MONTAGE-/REPARATURSTÄNDER

121,90 €

360°



- **faltbar** und **aufstellbar** in **Sekunden**
- **höhenverstellbar**
- Arbeitshöhe ca. 90 - 160 cm
- **Arm 360° drehbar** und **verstellbar**
- mit **Kunststoffablageschale (Art. 880068)**
- mit Kratzschutz-Klemmeinsatz (Art. 881049)
- im M-Wave Einzelkarton

UNIVERSAL WORKSTATION

- **foldable** and **defoldable** in **seconds**
- **height adjustable**
- working height approx. 90 - 160 cm
- **arm 360° turnable** and **adjustable**
- with **plastic tool tray (art. 880068)**
- with scratch protection clamping (art. 881049)
- in M-Wave box





ART.-NR. UVP	BESCHREIBUNG	DESCRIPTION	
881048 74,90 €	WAND-/WERKBANK-MONTAGE-/REPARATURSTÄNDER ›TOP ASSIST W&T‹ <ul style="list-style-type: none"> • für Wand- und Tischmontage • Schnellverschluss-Klemme und Arm 360° drehbar • mit Kratzschutz-Klemmeinsatz (Art. 881049) • mit Befestigungsmaterial • im M-Wave Einzelkarton 	WALL/WORKBENCH UNIVERSAL WORKSTATION ›TOP ASSIST W&T‹ <ul style="list-style-type: none"> • for wall and table mounting • QR clamp and arm 360° turnable • with scratch protection clamping (art. 881049) • with mounting material • in M-Wave box 	

	 EDELSTAHLSCHRAUBEN	STAINLESS STEEL SCREWS	
	<ul style="list-style-type: none"> • mit Innensechskantkopf nach DIN 912 • 50 Stück in M-Wave Kunststoffbox 	<ul style="list-style-type: none"> • with allen key head acc. to DIN 912 • 50 pcs in M-Wave plastic box 	
881990	M5 x 12 mm	M5 x 12 mm	
881991	M5 x 16 mm	M5 x 16 mm	
9,90 € / box			

881987	<ul style="list-style-type: none"> • M3 x 8 mm • mit Innensechskantsenkopf 	<ul style="list-style-type: none"> • M3 x 8 mm • with allen key countersunk head 	
0,09 €			

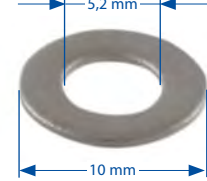
	EDELSTAHLMUTTERN	STAINLESS STEEL NUTS	
	<ul style="list-style-type: none"> • selbstsichernd nach DIN 985 • 100 Stück in M-Wave Kunststoffbox 	<ul style="list-style-type: none"> • self-locking acc. to DIN 985 • 100 pcs in M-Wave plastic box 	
881996	M5	M5	
881997	M6	M6	
11,90 € / box			

	EDELSTAHLUNTERLEGSCHIEBEN	STAINLESS STEEL WASHERS	
	<ul style="list-style-type: none"> • für M5 Schrauben • Innendurchmesser ca. 5,2/6,2 mm • Außendurchmesser 10/12 mm • 100 Stück in M-Wave Kunststoffbox 	<ul style="list-style-type: none"> • for M5 screws • inner diameter approx. 5.2/6.2 mm • outer diameter 10/12 mm • 100 pcs in M-Wave plastic box 	
4,90 € / box			

	BIKE-SCHLÜSSELANHÄNGER	BIKE KEY FOB	
	<ul style="list-style-type: none"> • Aluminium • mit M-Wave Logo • hellblau • im Polybeutel 	<ul style="list-style-type: none"> • aluminium • with M-Wave logo • light blue • in PE bag 	
1,50 €			

ART.-NR. UVP **BESCHREIBUNG**

DESCRIPTION

612030 E-BIKE MOTOR-SCHUTZHÜLLE ›E-PROTECT CENTER‹

27,90 €



- Universalgröße, ideal geeignet für **E-Bike-Motoren** von Shimano, Bosch, Brose, ...
- Größe flexibel anpassbar
- aus Neopren
- **schont den Motor** durch Isolierung
- **schützt** vor Kälte, Witterung und Schmutz
- **verhindert** Kratzer, Steinschlag und Stoßschäden
- in M-Wave Eurolochbox

E-BIKE MOTOR PROTECTION COVER ›E-PROTECT CENTER‹

- universal size, ideally suitable for **e-bike motors** of Shimano, Bosch, Brose, ...
- size flexibly adaptable
- made of neoprene
- **protects the motor** through isolation
- **protects** from coldness, weather condition and dirt
- **prevents** scratches, stone chipping and shock damages
- in M-Wave eurohole box



612010 E-BIKE AKKU-SCHUTZHÜLLE ›E-PROTECT‹

11,90 €



- **universell passend** für Bosch und Shimano Unterrohrakkus (kein original Bosch oder Shimano Ersatzteil)
- **verlängerte Akkulaufzeit** durch Isolierung
- aus Neopren
- **Schutz** vor Kälte und Witterung
- Schutz vor Kratzern, Steinschlag und Stoßschäden
- in M-Wave Eurolochbox

E-BIKE BATTERY PROTECTION ›E-PROTECT‹

- **universal suitable** for Bosch and Shimano down tube batteries (no original Bosch or Shimano spare part)
- isolation provides **extended battery capacity**
- made of neoprene
- **protection** from coldness and weather condition
- protection from scratches, stone chipping and shock damages
- in M-Wave eurohole box



612021 E-BIKE AKKU-SCHUTZHÜLLE ›E-PROTECT WRAP‹

16,90 €



- **Universalgröße** für in den Rahmen integrierte E-Bikes Akkus
- **verlängerte Akkulaufzeit** durch Isolierung
- **Schutz** vor Kälte und Witterung, Kratzern, Steinschlag und Stoßschäden
- aus Neopren
- in M-Wave Eurolochbox

E-BIKE BATTERY PROTECTION COVER ›E-PROTECT WRAP‹

- **universal size** for in the frame integrated e-bike batteries
- isolation provides **extended battery capacity**
- **protection** from coldness and weather condition, scratches, stone chipping and shock damages
- made of neoprene
- in M-Wave eurohole box



612020 E-BIKE AKKU-SCHUTZHÜLLE ›E-PROTECT CARRIER‹

21,90 €



- Universalgröße, ideal geeignet für **Gepäckträgerakkus** von Bosch (und Shimano)
- **verlängerte Akkulaufzeit** durch Isolierung
- **Schutz** vor Kälte und Witterung
- Schutz vor Kratzern, Steinschlag und Stoßschäden
- aus Neopren
- **mit Öffnung zum Laden** des Akkus im Gepäckträger (bei Bosch)
- in M-Wave Eurolochbox

E-BIKE BATTERY PROTECTION COVER ›E-PROTECT CARRIER‹

- universal size, ideally suitable for **carrier batteries** from Bosch (and Shimano)
- isolation provides **extended battery capacity**
- **protection** from coldness and weather condition
- protection from scratches, stone chipping and shock damages
- made of neoprene
- **with opening to charge** the battery inside the carrier (Bosch battery)
- in M-Wave eurohole box



122538 E-BIKE AKKUTASCHE ›ROUGH RIDE B‹

37,90 €



- universeller, gepolsterter **Transportschutz** für Unterrohr- und Gepäckträgerakkus
- **100 % wasserdicht**
- Rollverschluss ermöglicht **variable Größeneinstellung**
- hohe Reißfestigkeit durch verstärktes Ripstop-Gewebe
- **universelle und sichere** Befestigung durch breite Klettverschlüsse am **Rahmenrohr, Gepäckträger, ...**
- mit non-slip Einlagen und **Reflexlogo**
- Größe: ca. 55 x 8,5 x 13 cm (L x B x H)
- Volumen ca. 7 L

E-BIKE BATTERY BAG ›ROUGH RIDE B‹

- universal, padded **transport protection** for down tube and carrier batteries
- **100 % waterproof**
- **expandable** via roll cover
- high tear resistance through reinforced ripstop textile
- **universal and secure** mounting to the **frame tube, carrier, ...** with wide hook and loop fasteners
- with non-slip inlays and **reflex** logo
- size: approx. 55 x 8.5 x 13 cm (L x W x H)
- volume approx. 7 litres



ART.-NR. BESCHREIBUNG
UVP

DESCRIPTION

612022 E-BIKE AKKU KONTAKTSCHUTZ
›E-PROTECT CONNECT‹

9,90 €



- **Universalgröße** zur **Abdeckung der Anschlusskontakte** am Rahmen bei entnommenen E-Bike Akkus
- Schutz vor Schmutz, Wasser und Beschädigung
- aus Neopren
- auf M-Wave Eurolochkarte

E-BIKE BATTERY CONNECTOR COVER ›E-PROTECT CONNECT‹

- **universal size to cover the connection contacts** of the frame with removed e-bike batteries
- protection from dirt, water and damages
- made of neoprene
- on M-Wave eurohole card



612040 COCKPIT-/LENKER-ABDECKUNG

11,90 €



- schützt **E-Bike Displays**, Schalt- und Bremshebel, Computer, ... vor Staub, Schmutz, Regen, ...
- wasserabweisend
- universell passend für (fast) alle Lenkerformen
- mit Gummizug und 4 Klettverschlüssen
- auf M-Wave Eurolochkarte

COCKPIT/HANDLEBAR COVER

- protects **e-bike displays**, shift and brake levers, computer, ... against dust, dirt, rain, ...
- water resistant
- universally suitable for (almost) all handlebar shapes
- with rubber band and 4 hook and loop fasteners
- on M-Wave eurohole card



612027 E-BIKE REMOTE UND DISPLAY SCHUTZ
›E-PROTECT‹

6,90 €



- aus wasserabweisendem **Neopren**
- **universell passend** für (fast) alle **Remote-** und **Mitteldisplays** durch extra langen Klett- und zusätzlichen Kordeverschluss
- optimaler Schutz für Displays, Lenkerfernbedienungen, Anschlusskontakte, ...
- auf M-Wave Eurolochkarte

E-BIKE REMOTE AND DISPLAY PROTECTION ›E-PROTECT‹

- water resistant **neoprene** material
- **universally suitable** for (almost) all **remote** and **center displays** due to extra long hook and loop fastener and cord strap
- perfect protection for displays, remote lever, connection contacts, ...
- on M-Wave eurohole card



NOTIZEN

NOTES



Reflex Products	Reflex-Artikel Reflex Products Seite page 04	Mirrors	Spiegel Mirrors Seite page 77	Rims	Felgen Rims Seite page 126	Tire Accessories	Reifen-Zubehör Tire Accessories Seite page 163
Bags	Taschen Bags Seite page 09	Chains	Ketten Chains Seite page 80	Head sets & Accessories	Steuersätze & Zubehör Head sets & Accessories Seite page 127	Trailers	Anhänger Trailers Seite page 167
Lamps & Brackets	Lampen & Halter Lamps & Brackets Seite page 30	Pedals	Pedale Pedals Seite page 84	Handlebars & Accessories	Lenker & Zubehör Handlebars & Accessories Seite page 130	Roll Exercise Trainer	Rollentrainer Roll Exercise Trainer Seite page 174
Head Lamps & Rear Lights	Scheinwerfer & Rücklichter Head Lamps & Rear Lights Seite page 41	Hub Accessories	Nabenzubehör Hub Accessories Seite page 95	Grips	Griffe Grips Seite page 138	Bike/Sportswear	Bekleidung Bike/Sportswear Seite page 175
Locks	Schlösser Locks Seite page 44	Bottles	Trinkflaschen Bottles Seite page 97	Bells	Klingeln Bells Seite page 146	Sunglasses	Brillen Sunglasses Seite page 179
Computers	Computer Computers Seite page 57	Chainwheel Sets	Kettenradgarnituren Chainwheel Sets Seite page 105	Side Stands & Bike Holder	Parkstützen & Fahrradhalter Side Stands & Bike Holder Seite page 151	Helmets	Helme Helmets Seite page 182
Saddles & Saddle Covers	Sättel & Satteldecken Saddles & Saddle Covers Seite page 62	Bottom Brackets	Innenlager Bottom Brackets Seite page 107	Baskets	Körbe Baskets Seite page 155	Bicycle Care	Pflegemittel Bicycle Care Seite page 188
Seat Tube Clamps	Sattelklemmen Seat Tube Clamps Seite page 69	Brakes & Accessories	Bremsen & Zubehör Brakes & Accessories Seite page 108	Carriers	Gepäckträger Carriers Seite page 159	Tools	Werkzeuge Tools Seite page 191
Seat Posts	Sattelstützen Seat Posts Seite page 70	Mudguards	Schutzbleche Mudguards Seite page 119	Pumps	Pumpen Pumps Seite page 161	E-Bike Protection Covers	E-Bike Schutzhüllen E-Bike Protection Covers Seite page 200

messingschlager

Haßbergstr. 45
96148 Baunach - Germany
Tel.: +49 (0) 95 44 9444 - 0
www.m-wave-bike.com



Der Prospekt richtet sich nur an Kunden außerhalb Deutschlands.