

# messingschlager <sup>1924</sup>

THE BIKE EXPERIENCE



## 100 YEARS OF EXPERIENCE IN

- Developing
- Manufacturing
- Customising
- Full Service

## 2024

100 YEARS OF EXPERIENCE

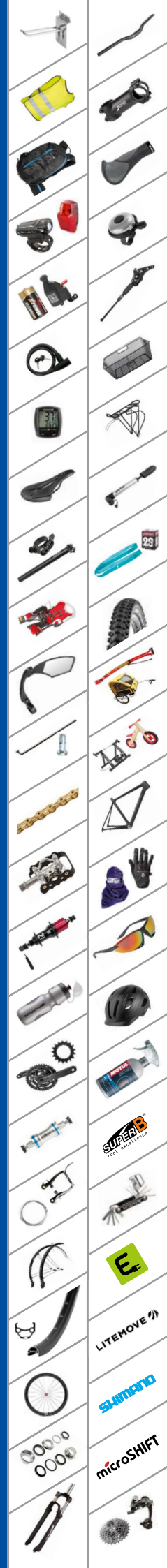

LITEMOVE  
SHIMANO  
microSHIFT



Head Office in Baunach, Germany

# *messingschlager*

## THE BIKE EXPERIENCE

**EUROPE'S LARGEST  
STOCK OF BIKE P & A**

**OVER 6000 ITEMS  
ON STOCK**

**WORLDWIDE DISTRIBUTION  
NETWORK**

**FAST, RELIABLE AND  
EXTENSIVE FULL SERVICE**

Forschung und Entwicklung in Europa und Amerika, Herstellung in Asien. Die Fahrradindustrie ist ein Paradebeispiel für eine globalisierte Welt. Allein die Anforderungen beim Import der Waren sind sehr vielschichtig und höchst anspruchsvoll.

Seit 100 Jahren importieren wir Waren aus Fernost, die wir teilweise gemeinsam mit unseren Partnern vor Ort selbst entwickelt haben. Diese langjährige Erfahrung ermöglicht es uns, alle Herausforderungen zu meistern. Kulturelle Unterschiede, abweichende Wertvorstellungen, beides gleichen wir mit einem hohen Maß an Verständnis und Effizienz aus.

Der Import von Fahrradzubehör ist unser Tagesgeschäft, das wir perfekt beherrschen. Und mehr noch: Langjährige Partnerschaften mit unseren Herstellern führen dazu, dass wir produktspezifische Wünsche kurzfristig und mit höchster Qualität umsetzen können.

Auf diese Expertise verlassen sich täglich Kunden in über 60 Ländern weltweit! Wie können wir Ihnen helfen?

Research and development in Europe and America, production in Asia. The bike industry is a prime example for a globalised world. Just the requirements of importing products are very wide-ranging and extremely challenging.

We have been importing products from Far East for 100 years which we partially developed with our partners there. Today we overcome all challenges with our extensive experience. Cultural differences, deviating values, we compensate both with a high level of understanding and efficiency.

The import of bike accessories is our daily business, which we perfectly master. And more: meanwhile a friendship connects us to the producers, which leads to the possibility to implement product-specific desires on short-term and with the highest quality.

Every day, people in more than 60 countries worldwide count on this expertise. How may we help you?





## **100 JAHRE ERFAHRUNG IN ... 100 YEARS OF EXPERIENCE IN ...**

### **DEVELOPING**

Unsere R&D-Abteilung und das Produktmanagement entwickeln unsere und Ihre Vorstellungen von Fahrradzubehör. Über einen engen Kontakt zu verschiedenen Herstellern in Asien gelingt uns die Umsetzung mit hoher Geschwindigkeit.

Our R&D department and the product management develop our and your visions for bike accessories. Due to the close contact with different producers in Asia, we are able to realise the implementation in high speed.

### **MANUFACTURING**

Wir sind der Experte für den Import aus Fernost, fertigen aber ebenso in Deutschland. Jüngstes Beispiel ist unsere Laufradmontage. Und das älteste Beispiel, das wir seit fast 100 Jahren im Portfolio haben: Satteldecken.

We are the expert for the import from the Far East, but we produce as well in Germany. Our latest example is our wheelset assembly. And the oldest example, which we have had for around 100 years in our portfolio: saddle cover.

### **CUSTOMISING**

Sie möchten Farben, Designs, Schriftzüge, Firmen- oder Ihr Markenlogo auf unseren Artikeln umsetzen? Sie wünschen sich einzigartige Varianten von unseren Produkten? Melden Sie sich, wir finden eine Lösung.

You require colours, designs, letterings, company or your brand logo on our items? You want unique variations of our products? Please contact us, we will find a solution.

### **FULL SERVICE**

Kulturelle Unterschiede, ungleiche Arbeitsweisen, volatile Wechselkurse, Zollprobleme, REACH-Anforderungen,... Wir kümmern uns um alles und liefern bis vor die Haustür. Und wenn Sie möchten, übernehmen wir auch die Lagerhaltung und die Finanzierung!

Cultural differences, unequal procedures, volatile exchange rates, customs problems, REACH-requirements,... We take care of everything and deliver right up to the front door. And if you want, we also assume the warehousing and the financing.

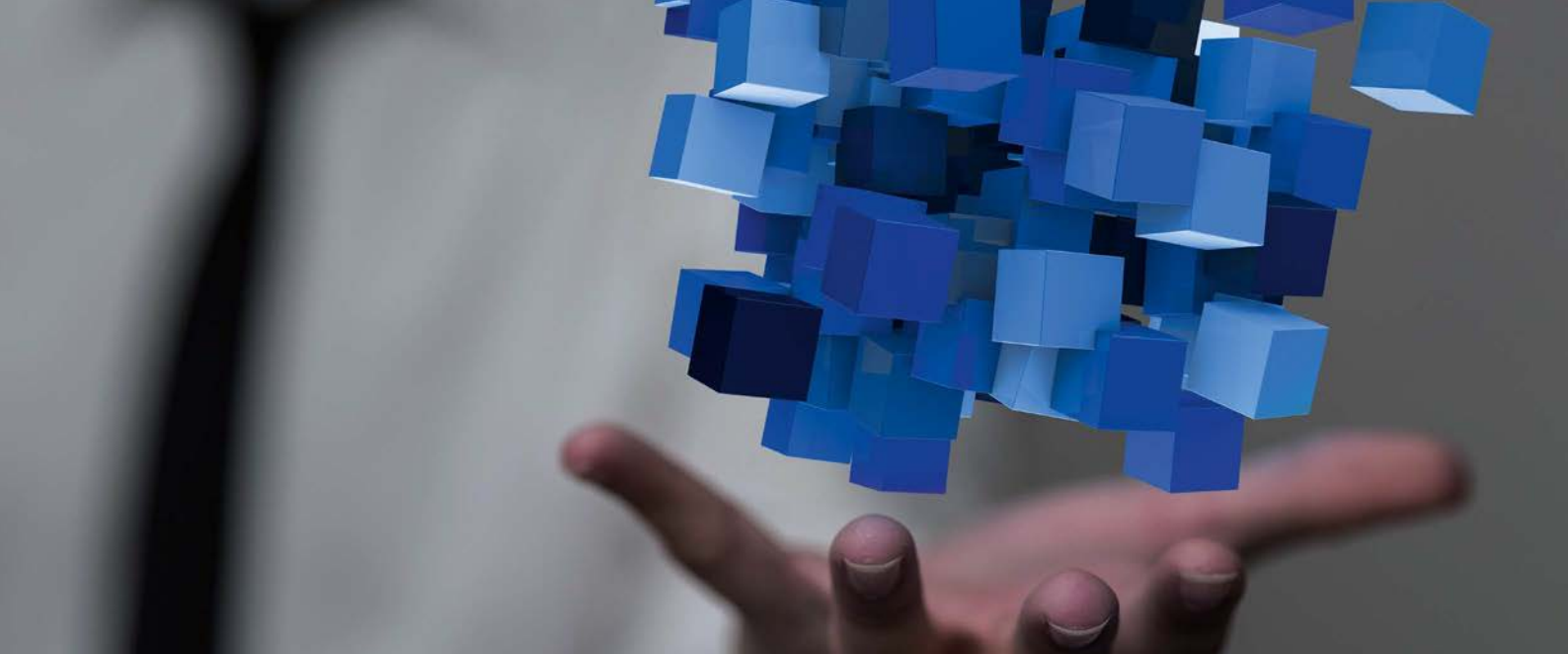

## IHRE VORTEILE

### Alles aus einer Hand

Das weltweite Sourcing von qualitativ hochwertigen und günstigen Herstellern ist eine umfangreiche und zeitintensive Aufgabe.

- ✓ Attraktives Sortiment
- ✓ Einfacher Bestellvorgang
- ✓ Alles aus einer Hand

### Weniger Kapitaleinsatz

Bestellungen in Fernost sind in der Regel mit großen Bestellmengen verbunden, wenn man attraktive Preise erzielen möchte. Dies ergibt eine große finanzielle Verpflichtung für Ihre Firma. Das übernehmen wir für Sie.

- ✓ Minimaler Kapitaleinsatz
- ✓ Geringes Risiko
- ✓ Attraktiver Preis

### Schnelle Verfügbarkeit

Geschwindigkeit ist im B2B und B2C Trumpf - wir arbeiten ausschließlich mit erprobten und renommierten Transportunternehmen zusammen.

- ✓ Automatisierte Logistik
- ✓ Hauseigene Software
- ✓ Schnell und kostengünstig

### Weniger Platzbedarf

Wir haben den Platz, den Sie sich sparen können. In Europas größtem Fahrradteil-lager können Sie Ihre Ware bei Bedarf ganz einfach abrufen.

- ✓ Just in Time
- ✓ Ware auf Abruf verfügbar
- ✓ Flexible Lösungen

## YOUR BENEFITS

### Everything from a single source

Sourcing from cheap and high-quality producers worldwide is an extensive and time-consuming task.

- ✓ Attractive Assortment
- ✓ Simple Ordering Process
- ✓ Everything from a single Source

### Less investment

In the Far East orders are usually associated with large amounts to achieve attractive prices. In total, this is a huge financial commitment for your business. We take over these financial commitments for you.

- ✓ Low Investment
- ✓ Low Risk
- ✓ Attractive Price

### Rapid availability

Speed is in the world of B2B and B2C your trump card - we only work with experienced and reputable carriers.

- ✓ Automated Logistics
- ✓ In-house Software
- ✓ Fast and Cost-Efficient

### Start saving place

We have the storage space which you can save in your own stock. In Europe's largest stock of bike P&A you can simply order the products as required.

- ✓ Just in Time
- ✓ Stock on Demand
- ✓ Flexible Solutions

# LOGISTIK LOGISTIC

Das vollautomatische Hochregal- und Kleinmengenlager sorgt für kurze Versandzeiten und eine kostengünstige und flexible Abwicklung. Auf über 16.000 Quadratmetern Fläche existieren, bei einer maximalen Höhe von 18 Metern, über 24.000 Lagerplätze, womit wir wohl das größte Fahrradteilelager Europas unterhalten.

Our fully automated highrack and small volume warehouse provides short delivery times and cost-effective, flexible management. At over 16,000 square meters exist at a maximum height of 18 meters over 24,000 storage locations, whereby we probably have Europe's largest stock of bike P&A!

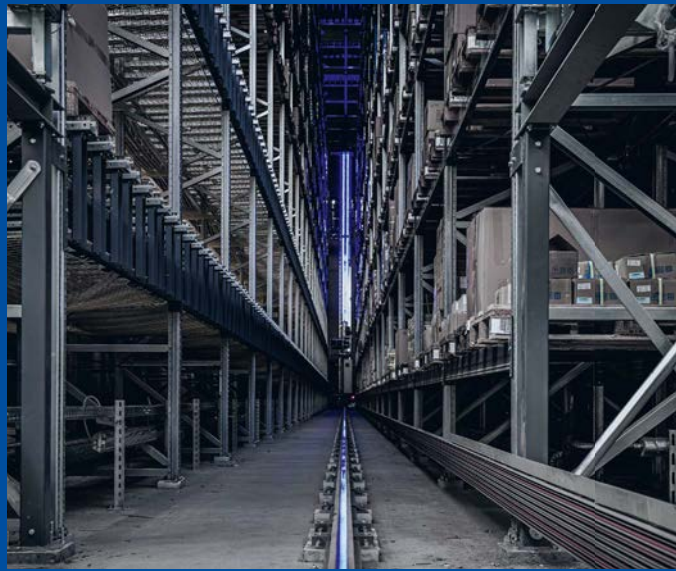

## SOZIALE VERANTWORTUNG SOCIAL COMMITMENT

Bei allem Erfolg darf die Not vieler Menschen nicht vergessen werden. Als international und nachhaltig tätiges Unternehmen sind wir uns unserer sozialen Verantwortung bewusst und unterstützen nationale und internationale Hilfsorganisationen und Stiftungen.

Despite all success we should not forget about the misery of many people. As an international and sustainably operating company, we are aware of our social responsibility and support national and international organisations and foundations.



## PRÄMIERTE LEISTUNG AWARD-WINNING WINNER

Wir streben täglich danach, uns zu verbessern, um unsere Kunden bestmöglichst zufriedenzustellen. Unabhängige Wettbewerbe erkennen das immer wieder an und zeichnen uns aus.

We strive to improve ourselves every day to satisfy our customers in the best way. Independent contests recognise and award this regularly.

**Bayerns Best 50** 2015  
**Großer Preis des Mittelstandes** 2014  
**Hidden Champions Award** 2013

**Bavaria's Best 50** 2015  
**Great Award of Medium-Sized Businesses** 2014  
**Hidden Champions Award** 2013

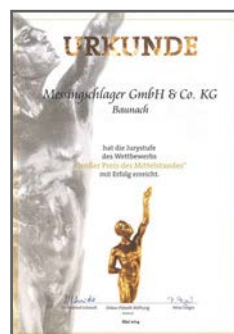



## VERPACKUNGEN PACKAGINGS



Verpackungen sind ein drängendes Problem unserer Zeit. Mikroplastik verschmutzt die Weltmeere. Wir versuchen insbesondere Plastik zu vermeiden, indem wir bei Auspolsterungen Papier verwenden und bereits in Produktion und Logistik auf Plastik so weit wie möglich verzichten. Falls es unumgänglich ist, setzen wir auf recyclebare oder kompostierbare Kunststoffe.

Packaging is a pressing problem of our time. Microplastics pollute the world's oceans. In particular, we try to avoid plastic by using paper for upholstery and avoiding plastic where possible in production and logistics. If it is unavoidable, we use recyclable or compostable plastics.

## „MACH MIT“: INSEKTENWIESE & MORE „TAKE PART“: INSECT MEADOW & MORE



Im Rahmen unserer firmeninternen Aktion „Mach Mit“ erhält jeder Monat ein neues Umweltprojekt als Motto. Beispielsweise starteten wir eine Initiative zur verbesserten Mülltrennung. Im April wurde auf einem mehrere hundert qm großen Grünstreifen eine Blumenwiese für Insekten angesät und Samenpackungen an alle Mitarbeiter für die Verwendung zu Hause verteilt.

As part of our in-house “Take Part!” campaign, each month receives a new environmental project as the motto. For example, we started an initiative to improve waste separation. In April, a flower meadow for insects was sown on a green strip of several hundred square meters and seed packets were distributed to all employees for use at home.

## SOLARSTROM SOLAR POWER



Einen großen Beitrag zum Klimaschutz liefert die Sonne. Bereits seit über 15 Jahren engagieren wir uns hier, indem wir die riesigen Dachflächen unser Lagerhallen mit Photovoltaikanlagen ausgerüstet haben. So können wir einen beträchtlichen Teil unseres Strombedarfs selbst erzeugen.

The sun makes a major contribution to climate protection. We have been involved here for over 15 years by equipping the huge roof areas of our warehouse with photovoltaic systems. In this way we can generate a considerable part of our electricity needs ourselves.

## STADTRADELN / MIT DEM RAD ZUR ARBEIT CITY CYCLING / BY BIKE TO WORK



Fahrradfahren ist praktizierter Klimaschutz. Deswegen fördern wir das Radeln, insbesondere auf dem Weg zur Arbeit, schon seit vielen Jahren. Wir stellen ein Team von über 50 Teilnehmern bei der alljährlichen Aktion „Stadtradeln“ und belegten auf Kreisebene den 2. Platz. Auch bei „Mit dem Rad zur Arbeit“ nehmen jedes Jahr viele Mitarbeiter teil. Intern fördern wir das Pendeln mit dem Rad zur Arbeit durch eine Lotterie, die Radfahrer belohnt.

Cycling is practiced climate protection. That is why we have been promoting cycling, especially on the way to work, for many years. We provide a team of over 50 participants in the annual “City Cycling” campaign and took second place at the district level. Many employees also take part in “By bike to work” every year. Internally, we encourage people to commute to work by bike through a lottery that rewards cyclists.



# WITH EACH OTHER FOR EACH OTHER

*TODAY, TOMORROW  
AND IN THE FUTURE.*



Wie wichtig Hilfe in Zeiten der Not ist, wird uns gerade jetzt wieder vor Augen geführt. Wir hatten den „Luxus“ in den vergangenen Jahrzehnten, dass über eine längere Phase kein größerer Krieg in Europa war.

Im Februar 2022 mussten wir lernen, wie schnell sich das ändern kann. Aber auch wo kein Krieg herrscht, gibt es viel unverschuldertes Leid und Not. Wir haben es uns zur Aufgabe gemacht, zumindest einen Teil davon zu lindern.

Just how important help is in times of need is being demonstrated to us again right now. We have had the „luxury“ in recent decades of not having a major war in Europe for an extended period of time.

In February 2022, we had to learn how quickly that can change. But even where there is no war, there is much suffering and hardship through no fault of our own. We have made it our mission to alleviate at least some of it.

*Benno Messingschlager*



# M-WAVE



## YOUR WORLD OF CYCLING

M-Wave, das sind erstklassige Produkte für alle Radfahrer, die insbesondere Funktion im Fokus haben. M-Wave bietet ein vollumfängliches Sortiment für Radfahrer mit technischem Anspruch, die auf der Suche nach innovativen und qualitativ wertigen Materialien sind.

Hinter M-Wave steht Entwicklung und Design aus Deutschland, eine Qualitätskontrolle auf höchstem Niveau, jahrelange praktische Erfahrung und das enorme Know-how von Europas größtem Importeur von Zweiradzubehör.

Das M-Wave Sortiment umfasst über 1000 Artikel mit überdurchschnittlichen Händlermargen, die weltweit in mehr als 70 Ländern verkauft werden.

M-Wave - these are first-class products for all cyclists who have a particular focus on function. M-Wave offers a complete range for cyclists with technical demand who are looking for innovative and quality materials.

M-Wave stands for development and design from Germany, a quality control at the highest level, many years of practical experience and the enormous know-how of Europe's largest importer of bicycle accessories.

The M-Wave range includes over 1000 items with above-average retail margins, sold in more than 70 countries worldwide.



### ALL A CYCLIST NEEDS

Egal ob Regen oder Sonnenschein, Tag oder Nacht, M-Wave bietet die passende Lösung.

Whether rain or sunshine, day or night, M-Wave offers the right solution.



### MAKE CYCLISTS HAPPY

Innovative Produkte, praktisches Design, bodenständige Preise: „Be happy“

Innovative products and functional designs at a fair price – ride with a smile!



### QUALITY MATERIALS

M-Wave Produkte entsprechen den höchsten Qualitäts- und Fertigungsstandards.

M-Wave products meet with the highest quality and manufacturing standards.



## PACKAGING DESIGN

Helles, leuchtendes Blau. Damit ziehen die konsequent einheitlich gestalteten M-Wave-Verpackungen die Aufmerksamkeit der Kunden auf sich.

Die optimierte Gestaltung der Verpackungen mit den wichtigsten Produktinformationen als Icons und zweisprachigen Stichpunkten gewährleistet, dass der Kunde sich schnell zurechtfindet und sich selbst bedienen kann. Die einheitliche Optik ermöglicht eine aufmerksamkeitsstarke, geschlossene Präsentation des M-Wave Sortiments in jedem Fachgeschäft.

Bright and brilliant blue. With this the uniformly designed M-Wave packaging attracts the attention of the customers.

The optimized design of the packaging with the most important product information as icons and bilingual bullet points ensures that the customer can quickly find his way and serve himself. The uniform look allows an eye-catching, closed presentation of the M-Wave assortment in every specialist shop.



## M-WAVE SHOP SYSTEM

### ALLES AUF EINEN BLICK - ALLES AUS EINER HAND

**Laden Sie den Kunden zum Kaufen ein!** Ein professionelles Shop-Design vermittelt Kompetenz, unterstützt Sie in der Beratung, begeistert Ihre Kunden und generiert profitablen Zusatzumsatz für Sie.

### YOUR ONE-STOP - SHOP SOLUTION

**Invite the customer to buy!**

A professional shop design conveys competence, supports you in consulting, inspires your customers and generates profitable additional sales for you.

## PREMIUM SLATWALL

Die Premium-Slatwall von M-Wave ermöglicht es Ihnen, die Produkte klar und übersichtlich zu präsentieren. Der Einsatz von PoS-Themenwelten führt Kunden gezielt zum Kontakt und Kennenlernen Ihrer Waren. Gerne unterstützen wir Sie mit thematischen und individuellen Bestückungsvorschlägen.

The premium Slatwall by M-Wave allows you to present the products clearly. The use of PoS theme worlds leads customers to a first contact and to get to know your goods. We are happy to assist you with thematic and individual assembly suggestions.



## OUR WEBSHOP

Alle M-Wave Produkte sind in unserem Webshop [www.messingschlager.com](http://www.messingschlager.com) übersichtlich mit allen wichtigen Eigenschaften und Verkaufsargumenten dargestellt. Sie können dort einfach und schnell bestellt werden!

All M-Wave products are presented in our webshop [www.messingschlager.com](http://www.messingschlager.com) clearly arranged with all important features and sales arguments. Just order your products here easily and quickly!

## [www.messingschlager.com](http://www.messingschlager.com)



# MESSINGSCHLAGER PART FINDER

Der Messingschlagler Part Finder ist eine Klassifizierungsmatrix für Fahrräder und Fahrradbauteile. Er klassifiziert Fahrräder nach den jeweiligen Einsatzgebieten in Anlehnung an die ASTM F2043-13 bzw. DIN EN 17406 (noch im Entwurfsstadium). Darüber hinaus liefert er Qualitätsstandards und Prüfprotokolle für erhöhte Lasten oder Einsatzgebiete, die über die gängigen Normen ISO4210 / EN15194 hinausgehen. Diese wurden in Zusammenarbeit mit unabhängigen, akkreditierten Prüfinstituten erarbeitet.

Der Messingschlagler Part Finder soll Händlern und Endverbrauchern helfen, sich in dem riesigen Angebot an Fahrrad-Bauteilen zurechtzufinden und zielsicher das passende, geprüfte Bauteil für die jeweiligen Bedürfnisse auszuwählen.

Fahrräder und somit auch die daran verbauten Bauteile werden für ein bestimmtes Einsatzgebiet und die hier zu erwartenden Belastungen entwickelt und konstruiert. Die Belastungen, die auf das Fahrrad bzw. die Bauteile einwirken, variieren je nach Einsatzgebiet und Systemgewicht (Fahrrad + Fahrer + Gepäck). Mit Hilfe der Piktogramme und der Infocharts, die auf allen betreffenden Verpackungen, im Katalog und im B2B Webshop abgebildet werden, kann problemlos und schnell das passende Bauteil gefunden werden.

The Messingschlagler Part Finder is a classification matrix for bicycles and bicycle components. It classifies bicycles according to the respective areas of application based on ASTM F2043-13 or DIN EN 17406 (still in the draft stage). In addition, it provides quality standards and test reports for increased loads or areas of application that are beyond the common standards ISO4210 / EN15194. These were developed in cooperation with independent, accredited testing institutes.

The Messingschlagler Part Finder is intended to help dealers and end users to find their way around the huge range of bicycle components and to select the right, tested component for their respective own needs.

Bicycles and thus the components installed on them are developed and constructed for a specific area of application and the loads to be expected here. The loads that affect the bike or the components, vary depending on the area of application and system weight (bike + rider + luggage). Using the pictograms and the info chart, which is printed on all relevant packaging in our catalogue and mentioned in the B2B shop the right component can be found quickly and easily.

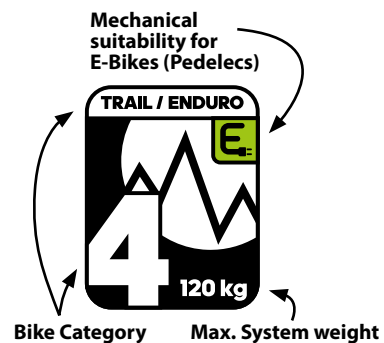

CITY / URBAN	TREKKING / GRAVEL	CROSS COUNTRY	TRAIL / ENDURO	GRAVITY / DH	ROAD RACE
1 ... kg	2 ... kg	3 ... kg	4 ... kg	5 ... kg	6 ... kg
<b>GROUND CONDITIONS</b>					
[Smooth road]			[Hilly terrain]		[Checkered flag]
<b>MAX. DROP/JUMP HEIGHT</b>					
0 cm	15 cm	60 cm	120 cm	190 cm	0 cm
<b>MAX. SYSTEM WEIGHT</b>					
[Bike icon] + [Rider icon] + [Luggage icon] = ... kg					





# Legende / Key

 Information zur Verpackungseinheit  
Hier: 500 Paar im Exportkarton, 50 Paar in Innenverpackung

500/50 pair

Information about packaging unit  
Here: 500 pairs in export box, 50 pairs in inner box



E-Bike optimiert  
E-bike optimized

AD

Artikel fällt unter das EU-Anti-Dumping-Gesetz  
Item comes under the law of EU-Anti-Dumping



Besonders geeignet für OEM Kunden  
Especially suitable for OEM customers

**NEW**

Artikel ist neu im Sortiment  
Item is new in the range

**NICE PRICE**

Artikel mit besonders gutem Preis-/ Leistungsverhältnis  
Item with particularly good price-performance-ratio

**TIP**

Artikel mit besonders interessanten Eigenschaften  
Item with particularly interesting features

**NEW DESIGN**









Artikel mit neuem Design  
Item with new design

**UPDATE**









Artikel mit neuen/verbesserten Eigenschaften  
Item with new/improved features

## SHOPAUSSTATTUNG

## SHOP EQUIPMENT

ART.-NR.	BESCHREIBUNG	DESCRIPTION	
			
<b>081010</b>	<b>AUSSTELLUNGSWAND</b>	<b>DISPLAY WALL</b>	
1	Mit unserer Displaywand können Sie Ihre <b>Markenprodukte optimal in Szene setzen!</b> <ul style="list-style-type: none"> <li>• 1-seitig</li> <li>• endlos erweiterbar und verknüpfbar</li> <li>• ca. 240 (H) x 104 (B) x 53 cm (T)</li> </ul>	With our display wall you can accentuate your <b>branded products in the best way!</b> <ul style="list-style-type: none"> <li>• 1-sided</li> <li>• endlessly expandable and attachable</li> <li>• approx. 240 (H) x 104 (W) x 53 cm (D)</li> </ul>	
<b>081012</b>	<b>Schildhalter</b> , passend für Art. 081010 und Art. 081006-97, (ohne Schild)	<b>sign bracket</b> , for art. 081010 and art. 081006-97, (without signboard)	
1			
	<b>Plexiglasschild</b> , passend für Art. 081012, 100 x 30 cm, von hinten beleuchtbar	<b>acrylic glass sign</b> , for art. 081012, 100 x 30 cm, translucent from behind	
<b>081047</b>	Kenda	Kenda	
<b>081006</b>	Velo	Velo	
<b>081058</b>	M-Wave	M-Wave	
<b>081007</b>	Novatec	Novatec	
<b>081032</b>	Beto	Beto	
<b>081097</b>	KMC	KMC	
<b>081057</b>	neutral	neutral	
2			

# SHOPAUSSTATTUNG SHOP EQUIPMENT

ART.-NR. 	BESCHREIBUNG	DESCRIPTION	
081060 1	<b>AUSSTELLUNGSWAND HALBHOC</b> <ul style="list-style-type: none"> <li>• <b>halbhoch</b> - ideal, damit der Kunde das gesamte Angebot überblicken kann</li> <li>• <b>beidseitig</b> bestückbar</li> <li>• endlos erweiterbar und verknüpfbar</li> <li>• ca. 151 (H) x 104 (B) x 95 cm (T)</li> </ul>	<b>DISPLAY WALL HALF-HEIGHT</b> <ul style="list-style-type: none"> <li>• <b>half-height</b> - perfectly clear shop arrangement for the customer</li> <li>• to be equipped on <b>two sides</b></li> <li>• endlessly expandable and attachable</li> <li>• approx. 151 (H) x 104 (W) x 95 cm (D)</li> </ul>	
081073 1	<b>STIRNSEITENELEMENT</b> <ul style="list-style-type: none"> <li>• <b>halbhoch</b></li> <li>• einseitig bestückbar</li> <li>• passend für Art. 081060</li> <li>• ca. 150 (H) x 60 (B) x 3 cm (T)</li> </ul>	<b>FRONT SIDE ELEMENT</b> <ul style="list-style-type: none"> <li>• <b>half-height</b></li> <li>• to be equipped on one side</li> <li>• for art. 081060</li> <li>• approx. 150 (H) x 60 (W) x 3 cm (D)</li> </ul>	
081017 1	<b>AUSSTELLUNGSSTÄNDER DREISEITIG</b> <ul style="list-style-type: none"> <li>• <b>freistehend</b></li> <li>• dreiseitig</li> <li>• <b>drehbar</b></li> <li>• sehr stabiler Stand durch schwere Fußplatte</li> <li>• ca. 158 (H) x 50 x 50 x 50 cm</li> </ul>	<b>DISPLAY 3 SIDED</b> <ul style="list-style-type: none"> <li>• <b>stand-alone</b></li> <li>• 3 sided</li> <li>• <b>turnable</b></li> <li>• super solid stand because of heavy base plate</li> <li>• approx. 158 (H) x 50 x 50 x 50 cm</li> </ul>	
081082 1	<b>HELM-AUSSTELLUNGSSTÄNDER ›TOP ASSIST‹</b> <ul style="list-style-type: none"> <li>• für bis zu <b>20 Helme</b></li> <li>• mit versetzbarem <b>Spiegel</b></li> <li>• <b>mobil</b> durch <b>4 Rollen</b></li> <li>• ca. 226 (H) x 60 (B) x 60 cm (T)</li> <li>• individueller Logo-Aufkleber auf Wunsch möglich</li> </ul>	<b>HELMET DISPLAY ›TOP ASSIST‹</b> <ul style="list-style-type: none"> <li>• for up to <b>20 helmets</b></li> <li>• with moveable <b>mirror</b></li> <li>• <b>mobile</b> by <b>4 rolls</b></li> <li>• approx. 226 (H) x 60 (W) x 60 cm (D)</li> <li>• individual logo sticker on request</li> </ul>	
	<b>EINFACHHAKEN</b> auch geeignet für Felgen, Laufräder, ...	<b>SINGLE HOOK</b> also suitable for rims, wheel sets, ...	
081120	100 mm	100 mm	
081121 200/10	200 mm	200 mm	
	<b>DOPPELHAKEN</b>	<b>DOUBLE HOOK</b>	
081122	100 mm	100 mm	
081123 100/10	200 mm	200 mm	



ART.-NR. 	BESCHREIBUNG	DESCRIPTION	
<p><b>081020</b> 10</p>	<p><b>ABLAGEN</b></p> <ul style="list-style-type: none"> <li>• verstellbar</li> <li>• für Prospekte, Artikel, ...</li> <li>• ca. 300 mm x 230 mm</li> </ul>	<p><b>SHELVES</b></p> <ul style="list-style-type: none"> <li>• adjustable</li> <li>• for brochures, items, ...</li> <li>• approx. 300 mm x 230 mm</li> </ul>	
<p><b>081021</b> 50</p>	<ul style="list-style-type: none"> <li>• aus Acryl</li> <li>• mit (Preis-) Auszeichnungsmöglichkeit</li> <li>• ca. 237 mm x 110 mm</li> </ul>	<ul style="list-style-type: none"> <li>• made of acrylic</li> <li>• with (price) displaying possibility</li> <li>• approx. 237 mm x 110 mm</li> </ul>	
<p><b>081024</b> 30</p>	<p><b>HELMHALTER</b></p>	<p><b>HELMET HOOK</b></p>	
<p><b>081071</b> 32</p>	<p><b>TASCHENHALTER</b></p> <ul style="list-style-type: none"> <li>• zur Präsentation von Gepäckträger-taschen</li> <li>• mit seitlichen Stützstreben</li> </ul>	<p><b>BAG HOOK</b></p> <ul style="list-style-type: none"> <li>• to present carrier bags</li> <li>• with lateral stability bars</li> </ul>	
<p><b>081025</b> 25</p> <p><b>081088</b> 50</p>	<p><b>LAUFRADHALTER</b></p> <p>für Gesamtansicht</p> <p>platzsparende Hochkantbefestigung, schwarz</p>	<p><b>WHEEL HOOK</b></p> <p>for full view</p> <p>space saving upright mounting, black</p>	
<p><b>081051</b> 10</p>	<p><b>(SCHLAUCH-) SPENDER</b></p> <ul style="list-style-type: none"> <li>• geeignet für Displaywand Art. 081010</li> <li>• <b>universell</b> bestückbar</li> <li>• mit (Preis-, Größen-, ...) <b>Auszeichnungsmöglichkeiten</b></li> <li>• ca. 480 (H) x 120 (T) x 85 (B) mm</li> </ul>	<p><b>(TUBE) DISPENSER</b></p> <ul style="list-style-type: none"> <li>• suitable for display wall art. 081010</li> <li>• can be equipped <b>variously</b></li> <li>• with (price, size, ...) <b>displaying possibilities</b></li> <li>• approx. 480 (H) x 120 (D) x 85 (W) mm</li> </ul>	





ART.-NR.	BESCHREIBUNG	DESCRIPTION	
	<p><b>EUROLOCHKARTEN UND -HEADER</b></p> <p>Das Verpacken auf Eurolochkarten ist meistens die <b>günstigste und vielseitigste Methode</b>, Produkte attraktiv im Laden anzubieten.</p> <p>Wir haben deshalb ein System entwickelt, mit dem wir fast <b>alle Artikel</b> an einer Eurolochkarte aus Karton befestigen oder im recyclefähigen PE-Beutel mit Header liefern können. Natürlich produzieren wir auch gerne Eurolochkarten oder Header mit Ihrem Logo oder bringen von Ihnen gewünschte Informationen per <b>Aufkleber</b> an.</p> <p>Design <b>M-Wave</b></p> <p><b>083115</b> Eurolochkarte 100 x 180 mm  <b>083128</b> Eurolochkarte 85 x 110 mm  <b>084510</b> Header 160 x (2x) 82,5 mm  <b>084509</b> Header 85 x (2x) 82,5 mm  <b>084231</b> Banderole 75 x (2x) 135 mm  <b>083173</b> Eurolochkarte für Sättel  <b>084090</b> Eurolochkarte für Schutzbleche  <b>084156</b> Eurolochkarte für Griffe (mit Lenkerendstopfen)  <b>084157</b> Eurolochkarte für Griffe (ohne Lenkerendstopfen)</p> <p>Design <b>Ventura</b></p> <p><b>083127</b> Eurolochkarte 100 x 180 mm  <b>084262</b> Eurolochkarte 85 x 110 mm  <b>084260</b> Header 145 x (2x) 60 mm  <b>084506</b> Header 85 x (2x) 82,5 mm</p>	<p><b>EUROHOLE CARDS AND HEADERS</b></p> <p>Eurohole cards are often the <b>most economic and versatile method</b> of packing and presenting products in a retail environment.</p> <p>Therefore we have developed a system by which we can deliver almost <b>all articles</b>, fastened on an eurohole card made of cardboard, or in a recyclable PE bag with header. Of course, we also can make deliveries with your own eurohole cards or your headers with your own logo. We can attach the information you require by <b>stickers</b>.</p> <p>Design <b>M-Wave</b></p> <p>eurohole card 100 x 180 mm  eurohole card 85 x 110 mm  header 160 x (2x) 82.5 mm  header 85 x (2x) 82.5 mm  banderole 75 x (2x) 135 mm  eurohole card for saddles  eurohole card for mudguards  eurohole card for grips (with handlebar plugs)  eurohole card for grips (without handlebar plugs)</p> <p>Design <b>Ventura</b></p> <p>eurohole card 100 x 180 mm  eurohole card 85 x 110 mm  header 145 x (2x) 60 mm  header 85 x (2x) 82.5 mm</p>	<p>Art. 083115 Art. 083128 Art. 084510  Art. 084231  Art. 084509  Art. 083173 Art. 084090  Art. 084156 Art. 084157  Art. 083127 Art. 084262 Art. 084260  Art. 084506</p>
	<p><b>INDIVIDUELLE AUSZEICHNUNG</b></p> <p>Auf Wunsch bringen wir mit einem Aufkleber weitere Informationen auf die Verpackung, z. B. <b>GTIN, UPC, Artikelnummern, Verkaufspreise, Verkaufstexte in anderen Sprachen, ...</b></p> <p>Unsere <b>hochwertigen transparenten Etiketten</b> können mit schwarz oder auf Anfrage mit weiß, sowie anderen Farben bedruckt werden. Auch bildliche Darstellungen finden so ihren Platz und geben jedem Produkt seine individuelle Verpackung.</p> <p><b>transparent</b>, mit schwarzem Aufdruck</p> <p><b>090660</b> 96 x 30 mm  <b>090661</b> 60 x 30 mm</p> <p><b>weiß</b>, mit schwarzem Aufdruck</p> <p><b>090665</b> 150 x 75 mm  <b>090673</b> 75 x 50 mm  <b>090677</b> 62 x 45 mm  <b>090670</b> 55 x 30 mm  <b>090654</b> 45 x 23 mm  <b>090663</b> 30 x 15 mm</p>	<p><b>INDIVIDUAL MARKING</b></p> <p>Made to your specifications, we can mark all articles with your or with our <b>GTIN, UPC, item numbers, sales prices, descriptions in different languages, ...</b></p> <p>We can offer you <b>high quality transparent stickers</b>. They can be labelled with black or on request with white or coloured imprints. Illustrations are possible as well. So every product can get its individual packaging.</p> <p><b>transparent</b>, with black imprint</p> <p>96 x 30 mm  60 x 30 mm</p> <p><b>white</b>, with black imprint</p> <p>150 x 75 mm  75 x 50 mm  62 x 45 mm  55 x 30 mm  45 x 23 mm  30 x 15 mm</p>	<p>BIKE MOUNT AHEAD  • Kettenschutzblech  • Kettenschutzblech  • Kettenschutzblech  • Kettenschutzblech</p> <p>150 mm</p> <p>Schutzblech-Set  26"-28"  (Art.Nr.:386085)  Preis: 4,95 €</p> <p>75 mm</p> <p>Schutzblech-Set 26"-28" (Art.Nr.:386085) Preis: 4,95 €  Schutzblech-Set 26"-28" (Art.Nr.:386085) Preis: 4,95 €  Schutzblech-Set 26"-28" (Art.Nr.:386085) Preis: 4,95 €</p>

# REFLECTIVE





ART.-NR.	BESCHREIBUNG	DESCRIPTION	
<p><b>120934</b></p> <p><b>120935</b></p> <p><b>120936</b></p> <p><b>120937</b></p> <p>100</p>	<p><b>WARNWESTE ›VEST ILLU‹</b></p> <ul style="list-style-type: none"> <li>entspricht der europäischen Norm <b>EN 17353</b> für Warnbekleidung – bereits Pflicht in vielen europäischen Ländern wie Deutschland, Italien, ...</li> <li>100 % Polyester</li> <li>mit <b>2 Reflexstreifen</b></li> <li><b>Weite sehr flexibel einstellbar</b> durch elastischen Gummiband</li> </ul> <p>Kindergröße XXS-XS</p> <p>Größe S - M</p> <p>Größe M - L</p> <p>Größe XL - XXL</p>	<p><b>REFLECTIVE VEST ›VEST ILLU‹</b></p> <ul style="list-style-type: none"> <li>conforms to European <b>EN 17353</b> for reflective clothing - already required in many European countries like Germany, Italy, ...</li> <li>100 % polyester</li> <li>with <b>2 reflective tapes</b></li> <li><b>very flexible width adjustment</b> by using an elastic rubber band</li> </ul> <p>child size XXS-XS</p> <p>size S - M</p> <p>size M - L</p> <p>size XL - XXL</p> <p>UVP 5,90 €</p>	 <p>Art. 120934</p> <p>Art. 120935-7</p>
<p><b>120939</b></p> <p><b>120940</b></p> <p><b>120941</b></p> <p>100</p>	<p><b>DREIECKSWESTE ›SASH ILLU‹</b></p> <ul style="list-style-type: none"> <li><b>super leicht</b>, atmungsaktiv und mit <b>maximaler Bewegungsfreiheit</b></li> <li>neongelbe Weste mit <b>Reflexstreifen</b> vorne, hinten und seitlich</li> <li>Universalgröße</li> <li><b>Weite sehr flexibel einstellbar</b> durch elastischen Gummiband und <b>verstellbaren</b> Klettverschlüssen</li> <li>für alle Outdoor-Aktivitäten, z. B. Radfahren, Joggen, Walking, ...</li> <li>im Polybeutel mit Euroloch</li> </ul> <p>Größe XS /S</p> <p>Größe M / L</p> <p>Größe XL / XXL</p>	<p><b>TRIANGLE VEST ›SASH ILLU‹</b></p> <ul style="list-style-type: none"> <li><b>super light</b>, breathable and offers <b>maximum mobility</b></li> <li>neon yellow vest with <b>reflective tapes</b> at the front, rear and sides</li> <li>unysize</li> <li><b>very flexible width adjustment</b> by using an elastic rubber band and <b>adjustable</b> hook and loop fasteners</li> <li>for all outdoor activities, e. g. cycling, jogging, walking, ...</li> <li>in PE bag with eurohole</li> </ul> <p>size XS /S</p> <p>size M / L</p> <p>size XL / XXL</p> <p>UVP 5,90 €</p>	
<p><b>120908</b></p> <p>120</p>	<p><b>LED-LEUCHTBAND ›WRAP FLASH‹</b></p> <ul style="list-style-type: none"> <li>für Arme, Beine, ...</li> <li><b>3M Scotchlite® reflektierendes</b>, neongelbes Band</li> <li>4 rote LEDs</li> <li>2 Funktionen: Dauer- und Blinklicht</li> <li>bis zu 300 m und <b>360°</b> sichtbar</li> <li>für alle Outdoor-Aktivitäten, z. B. Joggen, Walking, ...</li> <li>inkl. Batterie (1x CR 2032, Art. 640816)</li> <li>in M-Wave Blisterverpackung</li> </ul>	<p><b>LED LIGHT STRAP ›WRAP FLASH‹</b></p> <ul style="list-style-type: none"> <li>for arms, legs, ...</li> <li><b>3M Scotchlite® reflective</b>, neon yellow band</li> <li>4 red LEDs</li> <li>2 functions: steady and flashing light</li> <li>visibility up to 300 m and <b>360°</b></li> <li>for all outdoor activities, e. g. jogging, walking, ...</li> <li>incl. battery (1x CR 2032, art. 640816)</li> <li>in M-Wave blister packaging</li> </ul> <p>UVP 5,90 €</p>	<p><b>3M Scotchlite®</b> Reflective Material</p>  <p>360°</p>
<p><b>120903</b></p> <p>100/25 pair</p>	<p><b>HOSEN-/ARMBAND ›GEAR STRAP ILLU‹</b></p> <ul style="list-style-type: none"> <li>mit <b>Reflexstreifen</b></li> <li><b>Weite flexibel einstellbar</b> durch Gummieinlagen</li> <li>mit Klettverschluss</li> <li>paarweise im Polybeutel mit M-Wave Eurolochheader</li> </ul>	<p><b>TROUSERS/ARM STRAP ›GEAR STRAP ILLU‹</b></p> <ul style="list-style-type: none"> <li>with <b>reflective stripe</b></li> <li><b>flexible width adjustment</b> through rubber inserts</li> <li>with hook and loop fastener</li> <li>one pair in PE bag with M-Wave eurohole header</li> </ul> <p>UVP 3,90 €</p>	



ART.-NR. 	BESCHREIBUNG	DESCRIPTION	
<b>120902</b> 200 pair	<b>HOSEN-/ARMBAND ›SNAPWRAP‹</b> Einfach in geradem Zustand auf <b>Arm oder Bein schlagen</b> – fertig! <ul style="list-style-type: none"> <li>• selbstrollend</li> <li>• neongelb</li> <li>• 30 x 340 mm</li> <li>• paarweise auf M-Wave Eurolochkarte</li> </ul>	<b>TROUSERS/ARM STRAP ›SNAPWRAP‹</b> Just <b>hit it on the arm or leg</b> when it is uncurled - ready! <ul style="list-style-type: none"> <li>• self coiling</li> <li>• neon yellow</li> <li>• 30 x 340 mm</li> <li>• one pair on M-Wave eurohole card</li> </ul>	
<b>120964</b> 500/50 pair  <b>120965</b> 50 pair	<b>HOSENKLAMMERN ›ILLU PANTCLAMPS N‹</b> <ul style="list-style-type: none"> <li>• Stahl</li> <li>• verchromt</li> <li>• mit <b>Reflexstreifen</b></li> </ul> paarweise im Polybeutel  paarweise auf M-Wave Eurolochkarte	<b>TROUSERS CLAMPS ›ILLU PANTCLAMPS N‹</b> <ul style="list-style-type: none"> <li>• steel</li> <li>• c. p.</li> <li>• with <b>reflective stripe</b></li> </ul> one pair in PE bag  one pair on M-Wave eurohole card	
<b>120993</b> 500/100	<b>MAGNETKLAMMER ›ILLU LED‹</b> <ul style="list-style-type: none"> <li>• 4 weiße <b>LEDs</b></li> <li>• 2 Funktionen: <b>Dauer- und Blinklicht</b></li> <li>• mit <b>reflektierendem</b> Material</li> <li>• schnelle, einfache, universelle und schonende Anbringung durch <b>Magnetverschluss</b></li> <li>• für alle Outdoor-Aktivitäten, z. B. Joggen, Walking, ...</li> <li>• inkl. Batterie CR 2032 (Art. 640814)</li> <li>• auf M-Wave Eurolochkarte</li> </ul>	<b>MAGNET CLIP ›ILLU LED‹</b> <ul style="list-style-type: none"> <li>• 4 white <b>LEDs</b></li> <li>• 2 functions: <b>steady and flashing light</b></li> <li>• <b>reflective</b> material</li> <li>• quick, easy, universal and gentle mounting through <b>magnetic catch</b></li> <li>• for all outdoor activities e. g. jogging, walking, ...</li> <li>• incl. battery CR 2032 (art. 640814)</li> <li>• on M-Wave eurohole card</li> </ul>	
<b>120994</b> 500/100	<b>›MAGNET ILLU‹</b> <ul style="list-style-type: none"> <li>• aus <b>reflektierendem</b> Material</li> <li>• <b>schnelle, einfache, universelle und schonende</b> Anbringung durch <b>Magnetverschluss</b></li> <li>• auf M-Wave Eurolochkarte</li> </ul>	<b>›MAGNET ILLU‹</b> <ul style="list-style-type: none"> <li>• <b>reflective</b> material</li> <li>• <b>quick, easy, universal and gentle</b> mounting through <b>magnetic catch</b></li> <li>• on M-Wave eurohole card</li> </ul>	
<b>120990</b> 200 set	<b>REFLEXAUFKLEBER ›REFLICKERS SMILE‹</b> <ul style="list-style-type: none"> <li>• <b>3M Scotchlite® - Qualität</b></li> <li>• 4 gelbe Sticker mit schwarzem Aufdruck: 2 x Smile, 2 x 3M-Logo</li> <li>• auf M-Wave Eurolochkarte</li> </ul>	<b>REFLECTIVE STICKERS ›REFLICKERS SMILE‹</b> <ul style="list-style-type: none"> <li>• <b>3M Scotchlite® quality</b></li> <li>• 4 yellow stickers with black imprint: 2 x smile, 2 x 3M logo</li> <li>• on M-Wave eurohole card</li> </ul>	 <p><b>3M Scotchlite®</b> Reflective Material</p>



ART.-NR.	BESCHREIBUNG	DESCRIPTION	
<b>120901</b> 1.000	<b>REFLEKTOR FÜR SATTELGESTELL &gt;REFLICKER SWING&lt;</b> <ul style="list-style-type: none"> <li>• <b>schnelle, einfache Anbringung</b></li> <li>• aus <b>reflektierendem Material „3M Diamond“</b></li> <li>• erhöht Aufmerksamkeit durch <b>schwingende Befestigung</b> oder <b>Fixierung mit Kabelbinder</b></li> <li>• zweifarbig: rot und gelb</li> <li>• Größe ca. 89 x 60 mm</li> <li>• mit M-Wave Eurolochheader</li> </ul>	<b>REFLECTOR FOR SADDLE RAIL &gt;REFLICKER SWING&lt;</b> <ul style="list-style-type: none"> <li>• <b>quick, easy mounting</b></li> <li>• <b>reflective material “3M Diamond“</b></li> <li>• increases attention by <b>swinging mounting</b> or <b>fixation with cable ties</b></li> <li>• 2 colorway: red and yellow</li> <li>• size approx. 89 x 60 mm</li> <li>• with M-Wave eurohole header</li> </ul>	
<b>120992</b> 500/25 set	<b>REFLEXAUFKLEBER &gt;REFLICKERS BOW&lt;</b> <ul style="list-style-type: none"> <li>• <b>3M Scotchlite®-Qualität</b></li> <li>• <b>leicht gebogene Form</b></li> <li>• <b>1 Set = 16 Stück (8 x weiß, 8 x gelb)</b></li> <li>• ca. 0,7 x 10 cm</li> <li>• auf M-Wave Eurolochkarte</li> </ul> <p>Anbringung auf Felgen im Geltungsbereich der StVZO (Deutschland) unzulässig, da ohne deutsches Prüfzeichen.</p>	<b>REFLECTIVE STICKERS &gt;REFLICKERS BOW&lt;</b> <ul style="list-style-type: none"> <li>• <b>3M Scotchlite® quality</b></li> <li>• <b>slightly curved shape</b></li> <li>• <b>1 set = 16 pieces (8 x white, 8 x yellow)</b></li> <li>• approx. 0.7 x 10 cm</li> <li>• on M-Wave eurohole card</li> </ul>	
<b>120970</b> 200/10	<b>ABSTANDSFAHNE &gt;SF LONG&lt;</b> <ul style="list-style-type: none"> <li>• <b>klappbar</b></li> <li>• mit einer <b>roten LED</b></li> <li>• mit <b>Bewegungssensor</b></li> <li>• zur Montage am Gepäckträger oder an der Sitzrohrstrebe (Ø 8 - 20 mm!)</li> <li>• Dreiecksflagge mit <b>Reflexstreifen</b></li> <li>• Länge Ausleger: 360 mm</li> <li>• Größe Fahne: 200 x 120 mm</li> <li>• im Polybeutel mit M-Wave Eurolochheader</li> </ul> <p>Ohne deutsches Prüfzeichen - Verkauf und Nutzung im Geltungsbereich der StVZO (Deutschland) unzulässig (Abgabe nur an außerdeutsche Kunden).</p>	<b>REFLECTIVE FLAGPOLE &gt;SF LONG&lt;</b> <ul style="list-style-type: none"> <li>• <b>foldable</b></li> <li>• with one <b>red LED</b></li> <li>• with <b>movement sensor</b></li> <li>• to be mounted on the rear carrier or on the seat stay (Ø 8 - 20 mm!)</li> <li>• triangle flag with <b>reflective tapes</b></li> <li>• length extension arm: 360 mm</li> <li>• flag size: 200 x 120 mm</li> <li>• in PE bag with M-Wave eurohole header</li> </ul>	
<b>120971</b> 200	<b>ABSTANDSFAHNE &gt;SF SHORT&lt;</b> <ul style="list-style-type: none"> <li>• mit Sicherheitsende</li> <li>• Länge Ausleger: 380 mm</li> <li>• zur Montage am Gepäckträger</li> <li>• im Polybeutel mit M-Wave Eurolochheader</li> </ul>	<b>REFLECTIVE FLAGPOLE &gt;SF SHORT&lt;</b> <ul style="list-style-type: none"> <li>• with safety end</li> <li>• length extension arm: 380 mm</li> <li>• to be mounted on the rear carrier</li> <li>• in PE bag with M-Wave eurohole header</li> </ul>	
<b>120975</b> 50/10	<b>WIMPELSTANGE</b> <ul style="list-style-type: none"> <li>• zur Montage an der Hinterradachse</li> <li>• ideal für Kinder- und Lauflernfahrräder</li> <li>• 150 cm</li> <li>• in der Mitte <b>teilbar</b></li> <li>• im Polybeutel</li> </ul>	<b>REFLECTIVE FLAG</b> <ul style="list-style-type: none"> <li>• for mounting on the rear hub axle</li> <li>• ideal for children and running bikes</li> <li>• 150 cm</li> <li>• <b>divisible</b> in the middle</li> <li>• in PE bag</li> </ul>	

ART.-NR.	BESCHREIBUNG	DESCRIPTION	
<p><b>719890</b> Größe S</p> <p><b>719891</b> Größe M</p> <p><b>719892</b> Größe L</p> <p><b>719893</b> Größe XL 150/5 pair</p>	<p><b>FAHRRADHANDSCHUHE ›GLOW‹</b></p> <ul style="list-style-type: none"> <li>• <b>360° reflektierende</b> Applikationen</li> <li>• mit <b>non-slip-Noppen</b></li> <li>• Daumen und Zeigefinger mit spezieller Einlage zur <b>Touchscreenbedienung</b></li> <li>• mit <b>Ausziehhilfe</b></li> <li>• außen teilweise aus <b>elastischem Lycra</b></li> <li>• waschbar</li> <li>• atmungsaktiv</li> <li>• elastischer Bund</li> <li>• auf M-Wave Eurolochkarte</li> </ul>	<p><b>BICYCLE GLOVES ›GLOW‹</b></p> <ul style="list-style-type: none"> <li>• <b>360° reflective</b> applications</li> <li>• with <b>non-slip knobs</b></li> <li>• thumb and forefinger with contact area for <b>touchscreen operation</b></li> <li>• with loops as <b>take-off assistance</b></li> <li>• outside partly made of <b>elastic lycra</b></li> <li>• washable</li> <li>• breathable</li> <li>• elastic waistband</li> <li>• on M-Wave eurohole card</li> </ul>	 <p><b>GEL</b></p> <p><b>REFLEX</b></p> <p>UVP 13,90 €</p>
<p><b>715206</b> 150</p>	<p><b>HALS-/KOPFTUCH ›NEON YELLOW‹</b></p> <ul style="list-style-type: none"> <li>• 100 % Polyester <b>Funktions-Microfaser</b></li> <li>• <b>nahtlos, elastisch</b> und <b>atmungsaktiv</b></li> <li>• Größe: ca. 24 x 48 cm</li> <li>• auf M-Wave Eurolochkarte</li> </ul>	<p><b>TUBULAR HEADWEAR ›NEON YELLOW‹</b></p> <ul style="list-style-type: none"> <li>• 100 % Polyester <b>function microfibre</b></li> <li>• <b>seamless, elastic</b> and <b>breathable</b></li> <li>• size: approx. 24 x 48 cm</li> <li>• on M-Wave eurohole card</li> </ul>	 <p><b>57 g</b></p>  <p>UVP 3,90 €</p>
<p><b>730231</b> Größe XS, 46 - 52 cm Kopfumfang</p> <p><b>730230</b> Größe S, 52 - 57 cm Kopfumfang 10</p>	<p><b>KINDERHELM ›SMILE‹</b></p> <ul style="list-style-type: none"> <li>• <b>Microshell</b> Oberschale</li> <li>• große <b>Durchlüftungsöffnungen</b> mit <b>Mückenschutz</b></li> <li>• gelb</li> <li>• integriertes <b>Visier</b></li> <li>• kinderleichtes Verschlusssystem</li> <li>• an Kopfgröße anpassbar durch universelles, austauschbares <b>Ring-Kopfgrößeneinstellsystem</b></li> <li>• im M-Wave Einzelkarton</li> </ul>	<p><b>CHILDREN HELMET ›SMILE‹</b></p> <ul style="list-style-type: none"> <li>• <b>Microshell</b> face plate</li> <li>• big <b>holes for air circulation</b> with <b>fly net</b></li> <li>• yellow</li> <li>• integrated <b>visor</b></li> <li>• very simple closing</li> <li>• adjustable to head size by universal, interchangeable <b>ring head size adjustment system</b></li> <li>• in M-Wave box</li> </ul>	<p>according to EN 1078</p>  <p><b>RING SYSTEM</b></p> <p>UVP 21,90 €</p> <p>UVP 19,90 €</p> 

ART.-NR.	BESCHREIBUNG	DESCRIPTION	
<b>120997</b>  <b>120998</b> 200	<b>HELMÜBERZUG</b> <ul style="list-style-type: none"> <li>• <b>Regenschutz</b></li> <li>• <b>wasserabweisend</b></li> <li>• atmungsaktiv</li> <li>• neongelb mit <b>Reflex-Logo</b></li> <li>• auf M-Wave Eurolochkarte</li> </ul> <p>›Kids‹ Kindergröße XS - S</p> <p>›Peter‹ Größe M - L</p>	<b>HELMET COVER</b> <ul style="list-style-type: none"> <li>• <b>rain shelter</b></li> <li>• <b>water resistant</b></li> <li>• breathable</li> <li>• neon yellow with <b>reflective</b> logo</li> <li>• on M-Wave eurohole card</li> </ul> <p>›Kids‹ children size XS - S</p> <p>›Peter‹ size M - L</p> <p style="text-align: right;">UVP 5,90 €</p>	
<b>120995</b> 200 <b>NEW</b>	<b>HELMÜBERZUG ›MAASTRICHT‹</b> <ul style="list-style-type: none"> <li>• <b>komplett reflektierend für maximale Sichtbarkeit</b></li> <li>• <b>Regenschutz</b></li> <li>• wasserabweisend</li> <li>• durch Zugkordel für alle Größen anpassbar</li> <li>• auf M-Wave Eurolochkarte</li> </ul>	<b>HELMET COVER ›MAASTRICHT‹</b> <ul style="list-style-type: none"> <li>• <b>full reflex material for highest visibility</b></li> <li>• <b>rain shelter</b></li> <li>• waterproof</li> <li>• adjustable by drawstring for all sizes</li> <li>• on M-Wave eurohole card</li> </ul> <p style="text-align: right;">UVP 7,90 €</p>	
<b>122352</b> 100	<b>KORB + TASCHENÜBERZUG ›MAASTRICHT PROTECT‹</b> <ul style="list-style-type: none"> <li>• <b>universeller</b> Regenschutz für <b>Körbe</b>, Rucksäcke bis ca. 25 Liter, Vorderradtaschen, Gepäcktaschen, ...</li> <li>• mit <b>2 Haltegurten</b> auf der Rückseite</li> <li>• neongelb</li> <li>• <b>3M Scotchlite® Reflexstreifen</b> auf drei Seiten</li> <li>• mit aufgesetzter Netztasche</li> <li>• auf M-Wave Eurolochkarte</li> </ul>	<b>BASKET + BAG COVER ›MAASTRICHT PROTECT‹</b> <ul style="list-style-type: none"> <li>• <b>universal</b> rain protection for <b>baskets</b>, back bags up to approx. 25 litres, front bags, rear bags, ...</li> <li>• with <b>2 fixation straps</b> on back</li> <li>• neon yellow</li> <li>• <b>3M Scotchlite® reflective stripes</b> on three sides</li> <li>• with fitted net pocket</li> <li>• on M-Wave eurohole card</li> </ul> <p style="text-align: right;">UVP 10,90 €</p>	<p><b>3M Scotchlite®</b> Reflective Material</p> <p><b>2 X FIX</b></p>
<b>137940</b> 100 <b>NEW</b>	<b>SATTELDECKE ›URBAN‹</b> <ul style="list-style-type: none"> <li>• <b>20 mm Schaumstoffeinlage</b></li> <li>• schwarz mit <b>reflektierenden Seiten</b></li> <li>• durch Zugkordel für alle Größen anpassbar</li> <li>• auf M-Wave Eurolochkarte</li> </ul>	<b>SADDLE COVER ›URBAN‹</b> <ul style="list-style-type: none"> <li>• <b>20 mm foam pad</b></li> <li>• black with <b>reflective sideparts</b></li> <li>• adjustable by drawstring for all sizes</li> <li>• on M-Wave eurohole card</li> </ul> <p style="text-align: right;">UVP 6,90 €</p>	
<b>466670</b> 250 set  <b>466671</b> 7.560/360	<b>SPEICHENREFLEKTOR</b> <ul style="list-style-type: none"> <li>• <b>3M Scotchlite®</b> Reflexmaterial</li> <li>• <b>360° Sichtbarkeit</b></li> <li>• Länge: 70 mm</li> <li>• einfache, werkzeuglose Montage</li> <li>• mit <b>deutschem Prüfzeichen</b> (gültig bei Anbringung an 36 Speichen in einem Laufrad)</li> </ul> <p>1 Set = 18 Stück in M-Wave Blisterverpackung</p> <p>Montageverpackung</p>	<b>SPOKE REFLECTOR</b> <ul style="list-style-type: none"> <li>• <b>3M Scotchlite®</b> reflective material</li> <li>• <b>360° visibility</b></li> <li>• length: 70 mm</li> <li>• easy, toolless mounting</li> <li>• with <b>German approval number</b> (applies only when mounted on 36 spokes in one wheel)</li> </ul> <p>1 set = 18 pcs in M-Wave blister packaging</p> <p>OEM</p> <p style="text-align: right;">UVP 9,90 € UVP 0,59 €</p>	<p><b>3M Scotchlite®</b> Reflective Material</p>



WASSERDICHTE BIKEPACKING TASCHEN  
WATERPROOF BIKEPACKING BAGS



# BIKE PACKING











## M-WAVE BIKEPACKING-SERIE

- besonders reißfestes Ripstop-Gewebe
- 100 % wasserdicht
- jede Menge Stauraum
- extrem belastbar
- viele clevere Features

## M-WAVE BIKEPACKING-SERIES

- high tear-resistant ripstop fabric
- 100 % waterproof
- lots of storage space
- extremely resilient
- many clever features









ART.-NR.	BESCHREIBUNG	DESCRIPTION	  PREIS/LEISTUNG
<b>122630</b>          <b>122636</b> 20	<b>SATTeltasche ›ROUGH RIDE SADDLE‹</b> <ul style="list-style-type: none"> <li>• zum Transport von <b>Gepäck ohne Gepäckträger</b></li> <li>• <b>100 % wasserdicht</b></li> <li>• <b>Rollverschluss</b> für universelle Größeneinstellung</li> <li>• hohe Reißfestigkeit durch verstärktes Ripstop-Gewebe</li> <li>• sichere Befestigung mit zwei breiten Klettverschlüssen</li> <li>• aufgesetzte Gepäckgurte und Schlaufen zur zusätzlichen Gepäckbefestigung, zur Anbringung von Beleuchtung, Schutzblech, Luftpumpe, ...</li> </ul> <ul style="list-style-type: none"> <li>• <b>Größe L</b></li> <li>• Volumen bis ca. 11 Liter</li> <li>• ca. 53 x 13 x 15 cm</li> </ul>	<b>SADDLE BAG ›ROUGH RIDE SADDLE‹</b> <ul style="list-style-type: none"> <li>• to transport <b>luggage without carrier</b></li> <li>• <b>100 % waterproof</b></li> <li>• <b>roll cover</b> for individual size adjustment</li> <li>• high tensile strength through reinforced ripstop textile</li> <li>• secure mounting with two wide hook and loop fasteners</li> <li>• attached luggage belts and loops for the additional luggage connection, for attachment of lights, mudguard, pump, ...</li> </ul> <ul style="list-style-type: none"> <li>• <b>size L</b></li> <li>• volume approx. 11 litres</li> <li>• approx. 53 x 13 x 15 cm</li> </ul>	 <div style="border: 1px solid black; padding: 2px; display: inline-block;">L</div>  
<b>122625</b> 25	<ul style="list-style-type: none"> <li>• <b>Größe M</b></li> <li>• Volumen bis ca. 6 Liter</li> <li>• ca. 46 x 9 x 11 cm</li> <li>• schwarz/blau</li> </ul>	<ul style="list-style-type: none"> <li>• <b>size M</b></li> <li>• volume approx. 6 litres</li> <li>• approx. 46 x 9 x 11 cm</li> <li>• black/blue</li> </ul>	<div style="border: 1px solid black; padding: 2px; display: inline-block;">M</div> 



# WASSERDICHTE BIKEPACKING TASCHEN WATERPROOF BIKEPACKING BAGS









ART.-NR. 	BESCHREIBUNG	DESCRIPTION	
<p><b>122631</b></p> <p><b>122637</b> 25</p>	<p><b>LENKERTASCHE</b> ›ROUGH RIDE FRONT‹</p> <ul style="list-style-type: none"> <li>• einzeln verwendbarer, <b>100 % wasserdichter Packsack mit Rollverschluss</b></li> <li>• hohe Reißfestigkeit durch verstärktes Ripstop-Gewebe</li> <li>• <b>abnehmbares, transparentes Kartenfach</b> (Art. 122639)</li> <li>• sichere Befestigung mit drei universell versetzbaren Klettverschlüssen</li> <li>• Volumen bis ca. 10 Liter</li> <li>• ca. 59 x 23 cm</li> </ul> <p>schwarz / blau</p> <p>neongelb, besonders gute <b>Sichtbarkeit</b> durch <b>leuchtende Farbe</b> und <b>Reflexaufdruck</b></p>	<p><b>HANDLEBAR BAG</b> ›ROUGH RIDE FRONT‹</p> <ul style="list-style-type: none"> <li>• solo useable, <b>100 % waterproof duffel with roll cover</b></li> <li>• high tensile strength through reinforced ripstop textile</li> <li>• <b>removable, transparent card container</b> (art. 122639)</li> <li>• secure mounting with three universally displaceable hook and loop fasteners</li> <li>• volume approx. 10 litres</li> <li>• approx. 59 x 23 cm</li> </ul> <p>black / blue</p> <p>neon yellow, very good <b>visibility</b> due to <b>bright colour</b> and <b>reflective print</b></p> <p>UVP 29,90 €</p>	  
<p><b>122632</b></p> <p><b>122638</b> 25</p>	<p><b>RAHMEN-DREIECKSTASCHE</b> ›ROUGH RIDE TRIANGLE‹</p> <ul style="list-style-type: none"> <li>• <b>wasserdichter Reißverschluss und 100 % wasserdichte Innenauskleidung</b></li> <li>• <b>Volumen vergrößerbar</b> auf bis zu 4,2 Liter</li> <li>• variable Unterteilungsmöglichkeit des Hauptfachs</li> <li>• hohe Reißfestigkeit durch verstärktes Ripstop-Gewebe</li> <li>• sichere Befestigung mit fünf universell versetzbaren Klettverschlüssen (Art. 122627)</li> <li>• vier aufgesetzte Netztaschen für schnellen Zugriff auf wichtige Kleinutensilien</li> <li>• ca. 42 x 14 - 25 cm</li> </ul> <p>schwarz / blau</p> <p>neongelb, besonders gute <b>Sichtbarkeit</b> durch <b>leuchtende Farbe</b> und <b>Reflexaufdruck</b></p>	<p><b>FRAME TRIANGLE BAG</b> ›ROUGH RIDE TRIANGLE‹</p> <ul style="list-style-type: none"> <li>• <b>waterproof zipper and 100 % waterproof inner lining</b></li> <li>• <b>volume flexible</b> up to 4.2 litres</li> <li>• variable dividing possibilities of the main compartment</li> <li>• high tensile strength through reinforced ripstop textile</li> <li>• secure mounting with five universally displaceable hook and loop fasteners (art. 122627)</li> <li>• four attached net pockets for quick access to important small utensils</li> <li>• approx. 42 x 14 - 25 cm</li> </ul> <p>black / blue</p> <p>neon yellow, very good <b>visibility</b> due to <b>bright colour</b> and <b>reflective print</b></p> <p>UVP 44,90 €</p>	  
<p><b>122633</b></p> <p><b>122640</b></p> <p><b>122641</b> 50</p> <p><b>NEW</b></p>	<p><b>OBERRÖHRTASCHE</b> ›ROUGH RIDE TOP‹</p> <ul style="list-style-type: none"> <li>• <b>wasserdichter Reißverschluss und wasserdichte Innenauskleidung</b></li> <li>• erschütterungsabsorbierende, weiche Polstereinlage</li> <li>• verstärkter Boden</li> <li>• ca. 7 x 8,5 x 29 cm</li> </ul> <p>sichere Befestigung mit drei universellen <b>Klettverschlüssen</b></p> <p>schwarz</p> <p>neongelb, besonders gute <b>Sichtbarkeit</b> durch <b>leuchtende Farbe</b> und <b>Reflexaufdruck</b></p> <p>schwarz, <b>2 Ösen zur Direktmontage</b> am Rahmen</p>	<p><b>TOP TUBE BAG</b> ›ROUGH RIDE TOP‹</p> <ul style="list-style-type: none"> <li>• <b>waterproof zipper and waterproof inner lining</b></li> <li>• shock absorbing, soft padding</li> <li>• reinforced bottom</li> <li>• approx. 7 x 8.5 x 29 cm</li> </ul> <p>secure mounting with three universal <b>hook and loop fasteners</b></p> <p>black</p> <p>neon yellow, very good <b>visibility</b> due to <b>bright colour</b> and <b>reflective print</b></p> <p>black, <b>2 eyelets for direct mounting</b> on the frame</p> <p>UVP 21,90 €</p>	    

ART.-NR.	BESCHREIBUNG	DESCRIPTION	
<p></p> <p><b>BIKER SPEZIAL-RUCKSACK ›ROUGH RIDE BACK‹</b></p> <ul style="list-style-type: none"> <li>• <b>gepolsterte, atmungsaktive Schultertragegurte und Beckengurt</b></li> <li>• zusätzlicher, verstellbarer Brustgurt</li> <li>• Tragegestell und anpassbares Rücken- netzteil für <b>optimal belüfteten Trage- komfort</b></li> <li>• <b>integrierter Regenüberzug</b></li> <li>• <b>inkl. abnehmbarem Helmaufbe- wahrungsgestell</b></li> <li>• 1 Hauptfach und 4 kleinere Fächer mit Reißverschluss</li> <li>• integriertes <b>isoliertes</b> Fach für <b>Trinkblase</b></li> <li>• zusätzlich 2 äußere Fächer und 1 großes Innenfach</li> <li>• mit Rücklichthalter</li> <li>• Volumen ca. 15 Liter</li> <li>• ca. 46 x 28 x 12 cm</li> </ul> <p><b>122634</b> schwarz / blau</p> <p><b>122635</b> neongelb, besonders gute <b>Sichtbarkeit</b> 10 durch <b>leuchtende Farbe</b> und <b>Reflexauf- druck</b></p>	<p><b>BIKER SPECIAL BACKPACK ›ROUGH RIDE BACK‹</b></p> <ul style="list-style-type: none"> <li>• <b>padded, breathable shoulder straps and waist belt</b></li> <li>• additional, adjustable chest belt</li> <li>• carrying structure and adaptable back net for <b>optimally ventilated wearing comfort</b></li> <li>• <b>integrated rain cover</b></li> <li>• <b>incl. detachable helmet storage net</b></li> <li>• 1 main compartment and 4 smaller pockets with zipper</li> <li>• integrated <b>insulated</b> compartment for <b>water bag</b></li> <li>• additionally 2 outer compartments and 1 big inner compartment</li> <li>• with rear light strap</li> <li>• volume approx. 15 litres</li> <li>• approx. 46 x 28 x 12 cm</li> </ul> <p>black / blue</p> <p>neon yellow, very good <b>visibility</b> due to <b>bright colour</b> and <b>reflective print</b></p> <p>UVP 45,90 €</p>	 	
<p><b>BIKER RUCKSACK ›ROUGH RIDE BACK‹ INKL. WASSERBLASE ›SOURCE‹</b></p> <p><b>Hochwertige Wasserblase ›SOURCE‹</b> (Art. 122515)</p> <ul style="list-style-type: none"> <li>• 2-Liter-Wasserblase mit <b>anti- bakterieller Innenbeschichtung</b></li> <li>• 2.000 % <b>glattere Oberfläche</b> als herkömmliche TPU-Folien beugt Schimmelbildung vor</li> <li>• <b>große Öffnung</b> für schnelles und leichtes Befüllen und Reinigen</li> <li>• <b>geschmacksneutral</b> und <b>frei von BPA und Phthalaten</b></li> <li>• Trinkschlauch mit <b>antibakterieller Innenbeschichtung</b> und <b>auswechsel- barem Silikon-Mundstück</b> (Art. 122516)</li> </ul> <p><b>122620</b> schwarz / blau</p> <p><b>122621</b> neongelb, besonders gute <b>Sichtbarkeit</b> 10 durch <b>leuchtende Farbe</b> und <b>Reflexauf- druck</b></p>	<p><b>BIKER BACKPACK ›ROUGH RIDE BACK‹ INCL. WATER BAG ›SOURCE‹</b></p> <p><b>high-quality water bag ›SOURCE‹</b> (art. 122515)</p> <ul style="list-style-type: none"> <li>• 2-litres-water bag with <b>antimicrobial protection inside</b></li> <li>• 2,000 % <b>smoother surface</b> than conventional TPU foils prevents mould formation</li> <li>• <b>big opening</b> for fast and easy filling and cleaning</li> <li>• <b>tasteless and free from BPA and phthalates</b></li> <li>• drinking tube with <b>antimicrobial protection inside</b> and <b>exchangeable silicone bite valve</b> (art. 122516)</li> </ul> <p>black / blue</p> <p>neon yellow, very good <b>visibility</b> due to <b>bright colour</b> and <b>reflective print</b></p> <p>UVP 59,90 €</p>	<p><b>SOURCE</b></p>  <p>Art. 122516</p>	
<p><b>122538</b> 16 <b>E-BIKE AKKUTASCHE ›ROUGH RIDE B‹</b></p> <ul style="list-style-type: none"> <li>• universeller, gepolsterter <b>Transport- schutz</b> für Unterrohr- und Gepäck- trägerakkus (passend für fast alle Akku-Typen)</li> <li>• <b>100 % wasserdicht</b></li> <li>• Rollverschluss ermöglicht <b>variable Größeneinstellung</b></li> <li>• hohe Reißfestigkeit durch verstärktes Ripstop-Gewebe</li> <li>• <b>universelle</b> und <b>sichere</b> Befestigung durch breite Klettverschlüsse am <b>Rahmenrohr, Gepäckträger, ...</b></li> <li>• mit non-slip Einlagen und <b>Reflexlogo</b></li> <li>• Größe: ca. 55 x 8,5 x 13 cm (L x B x H)</li> <li>• Volumen ca. 7 L</li> </ul>	<p><b>E-BIKE BATTERY BAG ›ROUGH RIDE B‹</b></p> <ul style="list-style-type: none"> <li>• universal, padded <b>transport protec- tion</b> for down tube and carrier batteries (suitable for almost all battery types)</li> <li>• <b>100 % waterproof</b></li> <li>• <b>expandable</b> via roll cover</li> <li>• high tear resistance through rein- forced ripstop textile</li> <li>• <b>universal and secure</b> mounting to the <b>frame tube, carrier, ...</b> with wide hook and loop fasteners</li> <li>• with non-slip inlays and <b>reflex logo</b></li> <li>• size: approx. 55 x 8.5 x 13 cm (L x W x H)</li> <li>• volume approx. 7 litres</li> </ul> <p>UVP 37,90 €</p>	 	

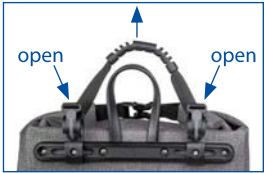

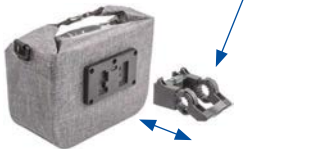
# WASSERDICHTE BIKEPACKING TASCHEN WATERPROOF BIKEPACKING BAGS



ART.-NR. 	BESCHREIBUNG	DESCRIPTION	
<b>122881</b> 15	<b>GEPÄCKTRÄGERTASCHE</b> <b>›SUBURBAN CARRY‹</b> <ul style="list-style-type: none"> <li>• <b>100 % wasserdicht</b> und staubdicht</li> <li>• mit <b>verschweißten Nähten</b></li> <li>• mit biologisch abbaubarer und sehr langlebiger <b>TPU-Beschichtung</b></li> <li>• sehr stabil und strapazierfähig trotz geringem Gewicht</li> <li>• <b>Rollverschluss</b> für universelle Größeneinstellung</li> <li>• mit entnehmbarem <b>Innentasche</b></li> <li>• integrierte Seitentasche mit <b>verschweißtem Reißverschluss</b></li> <li>• mit flexiblem Gummiband-Helmhalter</li> <li>• stabiler, verstellbarer <b>Clip-on</b>-Halter zur sekundenschnellen (De-)Montage über <b>Griffzug</b> an Gepäckträgerrohren von 9 - 16 mm (Ersatzhaken Art. 122889)</li> <li>• zusätzliche <b>3. Fixierungsmöglichkeit</b> an der Gepäckträgerstrebe</li> <li>• mit <b>Reflexaufdruck</b></li> <li>• Größe ca. 33 x 14,5 x 61 cm (L x B x H)</li> <li>• Volumen ca. 25 Liter</li> </ul>	<b>CARRIER SINGLE BAG</b> <b>›SUBURBAN CARRY‹</b> <ul style="list-style-type: none"> <li>• <b>100 % waterproof</b> and dustproof</li> <li>• with <b>heat-sealed joints</b></li> <li>• with biodegradable and very durable <b>TPU coating</b></li> <li>• very stable and hard-wearing despite low weight</li> <li>• <b>roll cover</b> for individual size adjustment</li> <li>• with detachable <b>inner bag</b></li> <li>• integrated side pocket with <b>heat-sealed zipper</b></li> <li>• with flexible rubber strap helmet holder</li> <li>• firm, adjustable <b>clip-on</b> bracket for (de-)mounting within seconds by <b>pulling the handle</b> on carrier tubes of 9 - 16 mm (replacement hook art. 122889)</li> <li>• additional <b>3rd mounting option</b> at the luggage stay</li> <li>• with <b>reflective print</b></li> <li>• size approx. 33 x 14.5 x 61 cm (L x W x H)</li> <li>• volume approx. 25 litres</li> </ul> <p style="text-align: right;">UVP 51,90 €</p>	 
<b>122882</b> 20	<b>LENKERTASCHE</b> <b>›SUBURBAN FRONT‹</b> <ul style="list-style-type: none"> <li>• <b>100 % wasserdicht</b> und staubdicht</li> <li>• mit <b>verschweißten Nähten</b></li> <li>• mit biologisch abbaubarer und sehr langlebiger <b>TPU-Beschichtung</b></li> <li>• sehr stabil und strapazierfähig trotz geringem Gewicht</li> <li>• <b>Rollverschluss</b> für universelle Größeneinstellung</li> <li>• <b>wasserdichtes, transparentes Sichtfenster</b> zur Bedienung eines <b>Touch-displays</b></li> <li>• integrierte Seitentaschen mit <b>verschweißtem Reißverschluss</b></li> <li>• stabiler 2-Punkt <b>Clip-on</b>-Halter mit einfacher (De-)Montage, passend für Lenker-Ø <b>22,2 - 31,8 mm</b> (Art. 122709)</li> <li>• absolut <b>verdrehsicher</b></li> <li>• innen mit zusätzlicher Versteifung</li> <li>• mit Schultergurt</li> <li>• mit <b>Reflexaufdruck</b></li> <li>• Größe ca. 13 x 28 x 21 cm (L x B x H)</li> <li>• Volumen ca. 7 Liter</li> </ul>	<b>HANDLEBAR BAG</b> <b>›SUBURBAN FRONT‹</b> <ul style="list-style-type: none"> <li>• <b>100 % waterproof</b> and dustproof</li> <li>• with <b>heat-sealed joints</b></li> <li>• with biodegradable and very durable <b>TPU coating</b></li> <li>• very stable and hard-wearing despite low weight</li> <li>• <b>roll cover</b> for individual size adjustment</li> <li>• <b>waterproof, transparent window</b> for operating a <b>touch display</b></li> <li>• integrated side pockets with <b>heat-sealed zipper</b></li> <li>• stable 2-point <b>clip-on</b> bracket with easy (de-)mounting, suitable for handlebar Ø <b>22.2 - 31.8 mm</b> (art. 122709)</li> <li>• absolutely <b>anti-twist</b></li> <li>• additional internal stiffness</li> <li>• with shoulder strap</li> <li>• with <b>reflective print</b></li> <li>• size approx. 13 x 28 x 21 cm (L x W x H)</li> <li>• volume approx. 7 litres</li> </ul> <p style="text-align: right;">UVP 38,90 €</p>	 
<b>122883</b> 40	<b>OBERROHRTASCHE</b> <b>›SUBURBAN TOP‹</b> <ul style="list-style-type: none"> <li>• <b>100 % wasserdicht</b> und staubdicht</li> <li>• mit <b>verschweißten Nähten und Reißverschluss</b></li> <li>• mit biologisch abbaubarer und sehr langlebiger <b>TPU-Beschichtung</b></li> <li>• sehr stabil und strapazierfähig trotz geringem Gewicht</li> <li>• <b>wasserdichtes, transparentes Sichtfenster</b> zur Bedienung eines <b>Touch-displays</b></li> <li>• für große Smartphones, wie iPhone X</li> <li>• sichere Befestigung mit 3 Klettverschlüssen</li> <li>• verstärkter Boden</li> <li>• mit <b>Reflexaufdruck</b></li> <li>• Größe ca. <b>18,5 x 9,5 x 8,5 cm</b> (L x B x H)</li> </ul>	<b>TOP TUBE BAG</b> <b>›SUBURBAN TOP‹</b> <ul style="list-style-type: none"> <li>• <b>100 % waterproof</b> and dustproof</li> <li>• with <b>heat-sealed joints and zipper</b></li> <li>• with biodegradable and very durable <b>TPU coating</b></li> <li>• very stable and hard-wearing despite low weight</li> <li>• <b>waterproof, transparent window</b> for operating a <b>touch display</b></li> <li>• for big smartphones like iPhone X</li> <li>• secure mounting with 3 hook and loop fasteners</li> <li>• reinforced bottom</li> <li>• with <b>reflective print</b></li> <li>• size approx. <b>18.5 x 9.5 x 8.5 cm</b> (L x W x H)</li> </ul> <p style="text-align: right;">UVP 14,90 €</p>	<div style="border: 1px solid black; padding: 2px; display: inline-block;"><b>XL</b></div>  





ART.-NR.	BESCHREIBUNG	DESCRIPTION	
122884 50	<b>SATTELTASCHE</b> ›SUBURBAN SADDLE‹ <ul style="list-style-type: none"> <li>• <b>100 % wasserdicht</b> und staubdicht</li> <li>• mit <b>verschweißten Nähten</b></li> <li>• mit biologisch abbaubarer und sehr langlebiger <b>TPU-Beschichtung</b></li> <li>• sehr stabil und strapazierfähig trotz geringem Gewicht</li> <li>• sichere Befestigung mit 3 Klettverschlüssen</li> <li>• <b>Rollverschluss</b> für universelle Größeneinstellung</li> <li>• mit <b>Reflexaufdruck</b></li> <li>• Größe ca. 20 x 9 x 9 cm (L x B x H)</li> <li>• Volumen max. 2,5 Liter</li> </ul>	<b>SADDLE BAG</b> ›SUBURBAN SADDLE‹ <ul style="list-style-type: none"> <li>• <b>100 % waterproof</b> and dustproof</li> <li>• with <b>heat-sealed joints</b></li> <li>• with biodegradable and very durable <b>TPU coating</b></li> <li>• very stable and hard-wearing despite low weight</li> <li>• secure mounting with 3 hook and loop fasteners</li> <li>• <b>roll cover</b> for individual size adjustment</li> <li>• with <b>reflective print</b></li> <li>• size approx. 20 x 9 x 9 cm (L x W x H)</li> <li>• volume max. 2.5 litres</li> </ul>	
122888 20	<b>SCOOTER-/LENKERTASCHE</b> ›SUBURBAN MESSENGER COMPACT‹ <ul style="list-style-type: none"> <li>• <b>100 % wasserdicht</b> und staubdicht</li> <li>• mit <b>verschweißten Nähten</b></li> <li>• mit biologisch abbaubarer und sehr langlebiger <b>TPU-Beschichtung</b></li> <li>• zusätzliche Außentasche</li> <li>• sehr stabil und strapazierfähig trotz geringem Gewicht</li> <li>• mit gepolstertem, verstellbarem Schultergurt</li> <li>• mit <b>Einschubtasche</b> am Schultergurt für Smartphones, ...</li> <li>• sichere Befestigung durch vier Klettverschlüsse an Fahrrädern, Rollern, ...</li> <li>• mit <b>Reflexaufdruck</b></li> <li>• Größe ca: 23 x 10,5 x 33 cm (L x B x H)</li> <li>• Volumen max. 8 Liter</li> </ul>	<b>SCOOTER/HANDLEBAR BAG</b> ›SUBURBAN MESSENGER COMPACT‹ <ul style="list-style-type: none"> <li>• <b>100 % waterproof</b> and dustproof</li> <li>• with <b>heat-sealed joints</b></li> <li>• with biodegradable and very durable <b>TPU coating</b></li> <li>• additional outer pocket</li> <li>• very stable and hard-wearing despite low weight</li> <li>• with padded, adjustable shoulder strap</li> <li>• with <b>slide-in pocket</b> at the shoulder strap for smartphones, ...</li> <li>• secure mounting with four hook and loop fasteners to bicycles, scooters, ...</li> <li>• with <b>reflective print</b></li> <li>• size approx. 23 x 10.5 x 33 cm (L x W x H)</li> <li>• volume max. 8 litres</li> </ul>	

UVP 19,90 €

CANADA PRO



CANADA PRO



CANADA PRO

<b>GEPÄCKTRÄGERTASCHE</b> <ul style="list-style-type: none"> <li>• <b>100 % wasserdicht</b> durch <b>verschweißte Nähte</b></li> <li>• extrem <b>strapazierfähiges</b> Material</li> <li>• stabiler <b>Rixen &amp; Kaul Clip-on</b>-Halter zur sekundenschnellen (De-)Montage an <b>Gepäckträgerrohren von 5 - 12 mm!</b> (Ersatzhaken = Art. 122702)</li> <li>• zusätzliche <b>3. Fixierungsmöglichkeit</b> an der Gepäckträgerstrebe (Ersatzhaken = Art. 122712)</li> <li>• Rollverschluss</li> <li>• <b>zusätzlicher</b> Schutz durch <b>Deckelverschlussklappe</b></li> <li>• mit <b>Tragegriffen</b> und Befestigungsringen für Schultergurt (Art. 122700)</li> <li>• Clip-Befestigungsmöglichkeiten für Packsack Art. 122730</li> <li>• <b>Verstärkungen</b> an der Unterseite</li> <li>• <b>Rücken- und Kantenschutz</b></li> <li>• mit <b>Reflexstreifen</b></li> <li>• paarweise im Polybeutel</li> </ul> <p>›ALBERTA‹ Volumen ca. <b>2 x 20 Liter</b></p> <p>122720 schwarz</p> <p>122728 rot</p> <p>6 pair</p>	<b>BICYCLE CARRIER BAG</b> <ul style="list-style-type: none"> <li>• <b>100 % waterproof</b> through <b>heat-sealed joints</b></li> <li>• extremely <b>tough</b> material</li> <li>• stable <b>Rixen &amp; Kaul clip-on</b> bracket for (de-)mounting within seconds on <b>tubes of carrier from 5 - 12 mm!</b> (replacement hook = art. 122702)</li> <li>• additional <b>3. mounting option</b> on the side bars of the carrier (replacement hook = art. 122712)</li> <li>• roll cover</li> <li>• <b>additional protection by top cover</b></li> <li>• with <b>handle</b> and fixation rings for shoulder strap (art. 122700)</li> <li>• clip fixing possibility for duffel bag art. 122730</li> <li>• <b>reinforcements</b> at the bottom</li> <li>• with <b>rear and edge protection</b></li> <li>• with <b>reflective stripes</b></li> <li>• one pair in PE bag</li> </ul> <p>›ALBERTA‹ volume approx. <b>2 x 20 litres</b></p> <p>black</p> <p>red</p> <p>UVP 124,00 € /pair</p>	
<p>122724 ›MANITOBA‹ 6 pair Volumen ca. <b>2 x 12,5 Liter</b></p>	<p>›MANITOBA‹ volume approx. <b>2 x 12.5 litres</b></p> <p>UVP 99,90 € / pair</p>	



# WASSERDICHTE GEPÄCKTASCHEN WATERPROOF BICYCLE BAGS





ART.-NR.	BESCHREIBUNG	DESCRIPTION	
<b>CANADA</b>		<b>CANADA</b>	
	<p><b>GEPÄCKTRÄGERTASCHE</b></p> <ul style="list-style-type: none"> <li>• <b>100 % wasserdicht</b> durch <b>verschweißte Nähte</b></li> <li>• extrem <b>strapazierfähiges</b> Material</li> <li>• hervorragendes Preis-/Leistungsverhältnis</li> <li>• stabiler, verstellbarer 3-Punkt <b>Clip-on-Halter</b> zur sekundenschnellen (De-)Montage an <b>Gepäckträgerrohren von 5 - 12 mm</b></li> <li>• zusätzliche <b>3. Fixierungsmöglichkeit</b> an der Gepäckträgerstrebe</li> <li>• Rollverschluss</li> <li>• <b>zusätzlicher</b> Schutz durch <b>Deckelverschlussklappe</b></li> <li>• mit <b>Tragegriffen</b> und Befestigungsringen für Schultergurt (Art. 122739)</li> <li>• <b>Verstärkungen</b> an der Unterseite</li> <li>• <b>Rücken- und Kantenschutz</b></li> <li>• mit <b>Reflexstreifen</b></li> <li>• paarweise im Polybeutel</li> </ul>	<p><b>BICYCLE CARRIER BAG</b></p> <ul style="list-style-type: none"> <li>• <b>100 % waterproof</b> through <b>heat-sealed joints</b></li> <li>• extremely <b>tough</b> material</li> <li>• great value</li> <li>• firm, adjustable <b>clip-on</b> 3-point bracket for (de-)mounting within seconds on <b>carrier tubes from 5 - 12 mm</b></li> <li>• additional <b>3. mounting option</b> on the side bars of the carrier</li> <li>• roll cover</li> <li>• <b>additional</b> protection by <b>top cover</b></li> <li>• with <b>handle</b> and fixation rings for shoulder strap (art. 122739)</li> <li>• <b>reinforcements</b> at the bottom</li> <li>• with <b>rear</b> and <b>edge protection</b></li> <li>• with <b>reflective stripes</b></li> <li>• one pair in PE bag</li> </ul>	 
<b>122722</b>	<p>›MONTREAL‹</p> <ul style="list-style-type: none"> <li>• Volumen ca. <b>2 x 20 Liter</b></li> <li>• für hinten</li> </ul>	<p>›MONTREAL‹</p> <ul style="list-style-type: none"> <li>• volume approx. <b>2 x 20 litres</b></li> <li>• for rear</li> </ul> <p style="text-align: right;">UVP 106,00 € / pair</p>	
<b>122725</b>	<p>›CALGARY‹</p> <ul style="list-style-type: none"> <li>• Volumen ca. <b>2 x 12,5 Liter</b></li> <li>• für vorne und hinten</li> </ul>	<p>›CALGARY‹</p> <ul style="list-style-type: none"> <li>• volume approx. <b>2 x 12.5 litres</b></li> <li>• for front and rear</li> </ul> <p style="text-align: right;">UVP 89,90 € / pair</p>	
<b>122880</b>	<p><b>GEPÄCKTRÄGERTASCHE</b></p> <p>›EDMONTON‹</p> <ul style="list-style-type: none"> <li>• <b>100 % wasserdicht</b> durch <b>verschweißte Nähte</b></li> <li>• <b>strapazierfähiges</b> Material</li> <li>• Volumen ca. 16 Liter</li> <li>• mit Netzaußentasche</li> <li>• stabiler, verstellbarer <b>Clip-on-Halter</b> zur sekundenschnellen (De-)Montage über <b>Griffzug</b> an Gepäckträgerrohren von 9 - 16 mm (Ersatzhaken Art. 122889)</li> <li>• zusätzliche <b>3. Fixierungsmöglichkeit</b> an der Gepäckträgerstrebe</li> <li>• mit Schultergurt</li> <li>• mit <b>Reflexmaterial</b> an den Seiten</li> </ul>	<p><b>CARRIER SINGLE BAG</b></p> <p>›EDMONTON‹</p> <ul style="list-style-type: none"> <li>• <b>100 % waterproof</b> through <b>heat-sealed joints</b></li> <li>• <b>tough</b> material</li> <li>• volume approx. 16 litres</li> <li>• with outer net pocket</li> <li>• firm, adjustable <b>clip-on</b> bracket for (de-)mounting within seconds by <b>pulling the handle</b> on carrier tubes of 9 - 16 mm (replacement hook art. 122889)</li> <li>• additional <b>3. mounting option</b> at the luggage stay</li> <li>• with shoulder strap</li> <li>• with <b>reflex material</b> on the sides</li> </ul> <p style="text-align: right;">UVP 29,90 €</p>	 
<b>122715</b>	<p><b>LENKERTASCHE</b> ›OTTAWA‹</p> <ul style="list-style-type: none"> <li>• <b>100 % wasserdicht</b> durch <b>verschweißte Nähte</b></li> <li>• extrem <b>strapazierfähiges</b> Material</li> <li>• stabiler 2-Punkt <b>Clip-on-Halter</b> (= Art. 122709) mit einfacher (De-)Montage, passend für Lenker-Ø <b>22,0 - 31,8 mm</b></li> <li>• absolut verdrehsicher auch bei max. Zuladung von 9 kg</li> <li>• herausnehmbare Innentasche</li> <li>• innen zusätzliche Versteifung</li> <li>• 2 zusätzliche Netzaußentaschen</li> <li>• mit <b>Reflexlabel</b></li> <li>• wasserdichte, abnehmbare und beidseitig verwendbare, transparente Kartentasche</li> <li>• mit Schultergurt</li> <li>• Volumen ca. 7 Liter</li> </ul>	<p><b>HANDLEBAR BAG</b> ›OTTAWA‹</p> <ul style="list-style-type: none"> <li>• <b>100 % waterproof</b> through <b>heat-sealed joints</b></li> <li>• extremely <b>tough</b> material</li> <li>• stable 2-point <b>clip-on</b> bracket (= art. 122709) with easy (de-)mounting, suitable for handlebar Ø <b>22.0 - 31.8 mm</b></li> <li>• anti-twist, also at max. load of 9 kg</li> <li>• removable inner pocket</li> <li>• additional internal stiffness</li> <li>• 2 additional outer net pockets</li> <li>• with <b>reflex label</b></li> <li>• waterproof, detachable and double-sided transparent map pocket</li> <li>• with shoulder strap</li> <li>• volume approx. 7 litres</li> </ul> <p style="text-align: right;">UVP 49,90 €</p>	 
<b>122737</b>	<p>Ersatz-/Zweit-Halter, passend für <b>E-Bike Mitteldisplays</b>, für Art. 122715, auf M-Wave Eurolochkarte</p>	<p>replacement /second bracket, suitable for <b>e-bike center display</b>, for art. 122715, on M-Wave eurohole card</p> <p style="text-align: right;">UVP 15,90 €</p>	

ART.-NR. 	BESCHREIBUNG	DESCRIPTION	
<b>122406</b> 80	<b>SMARTPHONE TASCHЕ</b> <b>›BLACK BAY‹</b> <ul style="list-style-type: none"> <li>• <b>100 % wasserdicht</b></li> <li>• Handy durch großes, transparentes Sichtfenster <b>bedienbar</b></li> <li>• ca. 17 x 8 x 1 cm (L x B x H)</li> <li>• durch Einlagen passend für alle gängigen Smart- und iPhones</li> <li>• mit <b>Universalhalter</b> für Ø 20 bis 60 mm, passend auch für Garmin (kein original Garmin Ersatzteil)</li> <li>• <b>breites Fenster</b> zur Nutzung des Smartphones als <b>Actionkamera</b></li> <li>• auf M-Wave Eurolochkarte</li> </ul>	<b>SMARTPHONE BAG</b> <b>›BLACK BAY‹</b> <ul style="list-style-type: none"> <li>• <b>100 % waterproof</b></li> <li>• mobile phone <b>operable</b> through large transparent window</li> <li>• approx. 17 x 8 x 1 cm (L x W x H)</li> <li>• suitable for all common smartphones and iPhones by inserts</li> <li>• with <b>universal bracket</b> for Ø 20 up to 60 mm, also suitable for Garmin (no original Garmin spare part)</li> <li>• <b>wide window</b> to use the smartphone as <b>action camera</b></li> <li>• on M-Wave eurohole card</li> </ul>	 <p>UVP 24,90 €</p>
<b>122730</b> 20	<b>PACKSACK</b> <b>›HUDSON BAY‹</b> <ul style="list-style-type: none"> <li>• <b>100 % wasserdicht</b> durch <b>verschweißte Nähte</b></li> <li>• extrem <b>strapazierfähiges</b> Material</li> <li>• mit <b>Tragegriffen</b> und Befestigungsringen für Schultergurt (Art. 122700)</li> <li>• universell einsetzbar</li> <li>• mit Bändern oder Gurten auf Seitentaschen fixierbar (auch 2 Stück!)</li> <li>• mit Rollverschluss und <b>Sichtfenster</b></li> <li>• mit <b>Reflexlabel</b></li> <li>• Volumen ca. 28 Liter, ca. 60 cm lang</li> </ul>	<b>DUFFLE BAG</b> <b>›HUDSON BAY‹</b> <ul style="list-style-type: none"> <li>• <b>100 % waterproof</b> through <b>heat-sealed joints</b></li> <li>• extremely <b>tough</b> material</li> <li>• with <b>handles</b> and fixation rings for shoulder strap (art. 122700)</li> <li>• universally useable</li> <li>• can be mounted on the side bags by straps (also 2 duffel bags!)</li> <li>• with roll cover and <b>window</b></li> <li>• with <b>reflex label</b></li> <li>• volume approx. 28 litres, approx. 60 cm long</li> </ul>	 <p>UVP 34,90 €</p>
<b>122739</b> 100	<b>SCHULTERGURT FÜR E-SCOOTER / FALTRÄDER</b> <ul style="list-style-type: none"> <li>• z. B. für Art. 659905/659885/659886, ...</li> <li>• Breite: 25 mm</li> <li>• im Polybeutel mit Einleger</li> </ul>	<b>SHOULDER STRAP FOR E-SCOOTER / FOLDING BIKES</b> <ul style="list-style-type: none"> <li>• e. g. for art. 659905/659885/659886, ...</li> <li>• width: 25 mm</li> <li>• in PE bag with sheet</li> </ul>	 <p>UVP 6,90 €</p>
<b>122522</b> 15	<b>UNIVERSALTASCHE</b> <b>›TRAVELLERS BAG‹</b> <ul style="list-style-type: none"> <li>• <b>100 % wasserdicht</b> durch <b>verschweißte Nähte</b></li> <li>• extrem <b>strapazierfähiges</b> Material</li> <li>• mit <b>Reflexaufdruck</b></li> <li>• ca. 605 x 385 x 550 mm (L x B x H)</li> <li>• Volumen ca. <b>120 Liter</b></li> <li>• auch passend für Gepäckanhänger (z. B. Art. 640081)</li> </ul>	<b>UNIVERSAL BAG</b> <b>›TRAVELLERS BAG‹</b> <ul style="list-style-type: none"> <li>• <b>100 % waterproof</b> through <b>heat-sealed joints</b></li> <li>• extremely <b>tough</b> material</li> <li>• with <b>reflective print</b></li> <li>• approx. 605 x 385 x 550 mm (L x W x H)</li> <li>• volume approx. <b>120 litres</b></li> <li>• also suitable for luggage trailer (e. g. art. 640081)</li> </ul>	<div style="border: 1px solid black; padding: 2px; display: inline-block;"><b>XL</b></div>  <p>UVP 49,90 €</p>



# WASSERDICHTE GEPÄCKTASCHEN WATERPROOF BICYCLE BAGS





ART.-NR. 	BESCHREIBUNG	DESCRIPTION	
122380 10	<b>MESSENGER TASCHЕ</b> <b>›LOCKERS BAY‹</b> <ul style="list-style-type: none"> <li>• <b>integrierter</b>, justierbarer <b>Gepäck-trägerhalter</b> (optimiert für linke Seite) mit <b>Reißverschlussabdeckung</b></li> <li>• große Innentasche mit 2 aufgesetzten Fächern</li> <li>• gepolstertes <b>15" Notebook</b> Rücken-fach mit Klettverschluss</li> <li>• zwei Außentaschen für Trinkflaschen, ...</li> <li>• Volumen ca. 25 Liter</li> <li>• justierbares Gurtband</li> <li>• <b>Reflexstreifen</b> rechts und links</li> </ul>	<b>MESSENGER BAG</b> <b>›LOCKERS BAY‹</b> <ul style="list-style-type: none"> <li>• <b>integrated</b>, adjustable <b>mount for rear carriers</b> (optimized for left side) with <b>zipper cover</b></li> <li>• big compartment with 2 attached pockets</li> <li>• padded <b>15" notebook</b> compart-ment with hook and loop fastener</li> <li>• two outer pockets for water bottles, ...</li> <li>• volume approx. 25 litres</li> <li>• adjustable belt</li> <li>• <b>reflective tape</b> on right and left side</li> </ul>	  <p>UVP 42,90 €</p>

NIEDERLANDE



NETHERLANDS



121920 8	<b>HARTSCHALEN-LENKERTASCHЕ</b> <b>›UTRECHT HC‹</b> <ul style="list-style-type: none"> <li>• <b>stabile, stoßfeste ABS-Kunststoff-Schalen</b></li> <li>• hochwertige, seidenmatte und struk-turierte Oberfläche</li> <li>• <b>wasserdicht</b> durch verschweißte Doppel-Reißverschlüsse</li> <li>• Stoffauskleidung innen</li> <li>• Maße: 26 x 16 x 19 cm (L x B x H)</li> <li>• Volumen ca. 8 Liter</li> <li>• mit Schultergurt</li> <li>• mit separater Innentasche</li> <li>• abnehmbare, transparente Karten-tasche</li> <li>• mit stabilem <b>Clip-on-Halter</b> (= Art. 122709) passend für <b>Ø 22,0 mm bis 31,8 mm</b></li> </ul>	<b>HARD SHELL-HANDLEBAR BAG</b> <b>›UTRECHT HC‹</b> <ul style="list-style-type: none"> <li>• <b>firm, shock-resistant ABS plastic shells</b></li> <li>• high quality, silk-matt and textured surface</li> <li>• <b>waterproof</b> due to sealed double zippers</li> <li>• fabric inner lining</li> <li>• size: 26 x 16 x 19 cm (L x W x H)</li> <li>• volume approx. 8 litres</li> <li>• with shoulder belt</li> <li>• with separate inner pocket</li> <li>• detachable transparent map pocket</li> <li>• with stable <b>clip-on bracket</b> (= art. 122709) suitable for <b>Ø 22.0 mm up to 31.8 mm</b></li> </ul>	  <p>UVP 35,90 €</p>
-------------	---	--	---



ART.-NR. 	BESCHREIBUNG	DESCRIPTION	
<p><b>122460</b></p> <p><b>122470</b> 6</p>	<p><b>GEPÄCKTRÄGERBOX/TOPCASE</b> ›AMSTERDAM BOX L‹</p> <ul style="list-style-type: none"> <li>• <b>absperribar</b>, inkl. 2 Schlüssel (Ersatzschloß + Federclip + 2 Schlüssel = Art. 122466)</li> <li>• aus hochwertigem Kunststoff</li> <li>• <b>staub- und wasserfest</b></li> <li>• <b>Volumen ca. 17 Liter</b></li> <li>• Maße: 42 x 26 x 21 cm (L x B x H)</li> <li>• zur Montage auf dem Gepäckträger</li> <li>• mit 2 Seitenverschlüssen (Art. 122467)</li> </ul> <p>im Einzelkarton</p> <p>mit Info-Aufkleber im Polybeutel Spart Verpackungsvolumen!</p>	<p><b>CARRIER TOP CASE</b> ›AMSTERDAM BOX L‹</p> <ul style="list-style-type: none"> <li>• <b>lockable</b>, incl. 2 keys (replacement lock + spring clip + 2 keys = art. 122466)</li> <li>• high quality plastic</li> <li>• <b>dust and water resistant</b></li> <li>• <b>volume approx. 17 litres</b></li> <li>• size: 42 x 26 x 21 cm (L x W x H)</li> <li>• for fixing on the rear carrier</li> <li>• with 2 closing parts (art. 122467)</li> </ul> <p>in box</p> <p>with info sticker in PE bag Saves packaging volume!</p> <p>UVP 49,90 €</p> <p>UVP 46,90 €</p>	<p><b>L</b></p>  <p>Images showing the carrier top case (L) in its box, with keys, and mounted on a bicycle rear carrier.</p>
<p><b>122463</b> 5</p> <p><b>122464</b> 10</p>	<p><b>GEPÄCKTRÄGERBOX</b></p> <ul style="list-style-type: none"> <li>• Klemmbügel für sicheren Verschluss</li> <li>• Vorrichtung für <b>Vorhängeschloß</b></li> <li>• 4 <b>Spanngurthalter</b> (Art. 122490)</li> <li>• aus hochwertigem Kunststoff</li> <li>• <b>staub- und wasserfest</b></li> <li>• zur Montage auf dem Gepäckträger</li> </ul> <p>›AMSTERDAM EASY BOX XL‹</p> <ul style="list-style-type: none"> <li>• Volumen ca. <b>18 Liter</b></li> <li>• Maße: 42 x 31 x 22 cm (L x B x H)</li> </ul> <p>›AMSTERDAM EASY BOX S‹</p> <ul style="list-style-type: none"> <li>• Volumen ca. <b>5 Liter</b></li> <li>• Maße: 27 x 20 x 15 cm (L x B x H)</li> </ul>	<p><b>CARRIER TOP CASE</b></p> <ul style="list-style-type: none"> <li>• clamp for safe closure</li> <li>• fixing point for <b>padlock</b></li> <li>• 4 <b>tension belt brackets</b> (art. 122490)</li> <li>• high quality plastic</li> <li>• <b>dust and water resistant</b></li> <li>• for mounting on the rear carrier</li> </ul> <p>›AMSTERDAM EASY BOX XL‹</p> <ul style="list-style-type: none"> <li>• volume approx. <b>18 litres</b></li> <li>• size: 42 x 31 x 22 cm (L x W x H)</li> </ul> <p>›AMSTERDAM EASY BOX S‹</p> <ul style="list-style-type: none"> <li>• volume approx. <b>5 litres</b></li> <li>• size: 27 x 20 x 15 cm (L x W x H)</li> </ul> <p>UVP 34,90 €</p> <p>UVP 24,90 €</p>	<p><b>L-XL</b></p> <p><b>S-M</b></p>  <p>Images showing the Easy Box XL and Easy Box S, both in their boxes and open to show interior compartments.</p>
<p><b>122465</b> 50</p>	<p>Ersatzverschluss</p>	<p>replacement closing part</p> <p>UVP 2,90 €</p>	 <p>Image of the replacement closing part for the Easy Boxes.</p>
<p><b>122491</b> 100</p>	<p>Ersatzstopfen zur Befestigung des Deckels</p>	<p>replacement plugs to mount the top</p> <p>UVP 0,49 €</p>	 <p>Image of the replacement plug used for mounting the top of the Easy Boxes.</p>
<p><b>122492</b> 50 set</p>	<p>Ersatzmontage-Set</p>	<p>replacement mounting parts</p> <p>UVP 1,99 €</p>	 <p>Images showing the replacement mounting parts, including straps and buckles.</p>
<p><b>122479</b> 10</p>	<p><b>LENKERBOX</b> ›AMSTERDAM BOX FRONT‹</p> <ul style="list-style-type: none"> <li>• <b>abschließbar</b>, inkl. 2 Schlüssel</li> <li>• zur Montage am Steuersatz (1") und der Vorderradnabe (Adapter für 1½" Steuersatz erhältlich = Art. 431799)</li> <li>• aus Kunststoff</li> <li>• <b>staub- und spritzwassergeschützt</b></li> <li>• passend für 26" - 29" Reifen</li> <li>• Bügel zum leichten Öffnen und zum Schutz des Schließzylinders</li> <li>• Volumen ca. 17 Liter</li> <li>• Maße: 23 x 26 x 33 cm</li> </ul>	<p><b>FRONT TOP CASE</b> ›AMSTERDAM BOX FRONT‹</p> <ul style="list-style-type: none"> <li>• <b>lockable</b>, incl. 2 keys</li> <li>• for mounting at the head set (1") and the front wheel hub (adapter for 1½" head set available = art. 431799)</li> <li>• plastic</li> <li>• <b>dust and water protected</b></li> <li>• suitable for 26" - 29" tires</li> <li>• bracket for easy opening and for protection of the lock cylinder</li> <li>• volume approx. 17 litres</li> <li>• size: 23 x 26 x 33 cm</li> </ul> <p>UVP 27,90 €</p>	 <p>Images showing the front top case (Front) mounted on a bicycle handlebar and the front wheel hub.</p>



ART.-NR. 	BESCHREIBUNG	DESCRIPTION	
<p><b>122310</b> 5</p>	<p><b>GEPÄCKTRÄGERTASCHE ›AMSTERDAM TRIPLE‹</b></p> <p>ein Modell voller guter Ideen:</p> <ul style="list-style-type: none"> <li>• Hauptfächer durch Kunststoffböden <b>verstärkt</b></li> <li>• Gesamtbreite ca. 65 cm</li> </ul> <p><b>Seitentaschen:</b></p> <ul style="list-style-type: none"> <li>• Maße: 34 x 17 x 32 cm (L x B x H), Inhalt ca. 34 Liter</li> <li>• <b>großes Hauptfach</b>, durch regengeschützten Reißverschluss von der Seite zugänglich, <b>kein umständliches Suchen!</b></li> <li>• aufgesetzte <b>Seitentasche</b> und <b>Hecktasche</b> (als Flaschenhalter verwendbar)</li> <li>• mit <b>Reflexstreifen</b></li> <li>• mit <b>Schnellverschluss</b> am Gepäckträger zu befestigen und Aussparungen für Gepäckträgerklemme</li> <li>• mit <b>Tragegriff</b> zwischen den Taschen</li> </ul> <p><b>Toptasche:</b></p> <ul style="list-style-type: none"> <li>• Maße: 34 x 46 x 21 cm, ca. 28 Liter</li> <li>• mit <b>Schnellverschluss</b> an den Seitentaschen befestigt</li> <li>• bei Bedarf kann eine zweite Toptasche aufgesetzt werden!</li> <li>• durch langen, regengeschützten Reißverschluss in allen Ecken leicht zugänglich</li> <li>• mit <b>aufgesetzter Kleinteiletasche</b>, <b>flexiblem Helmhalter</b> und <b>Tasche</b> darunter</li> <li>• kann als <b>Rucksack</b> getragen werden!</li> <li>• mit <b>Tragegriff</b>, <b>Schultergurt</b> und <b>Rücklichthalter</b></li> </ul>	<p><b>BICYCLE CARRIER BAG ›AMSTERDAM TRIPLE‹</b></p> <p>this model is full of good ideas:</p> <ul style="list-style-type: none"> <li>• main compartments <b>reinforced</b> by plastic walls</li> <li>• total width approx. 65 cm</li> </ul> <p><b>side bags:</b></p> <ul style="list-style-type: none"> <li>• size: 34 x 17 x 32 cm (L x W x H), content approx. 34 litres</li> <li>• <b>large main compartment</b>, accessible from the side by rain protected zipper, <b>no long-winded searching!</b></li> <li>• attached <b>side bag</b> and <b>rear bag</b> (usable as bottle cage)</li> <li>• with <b>reflective stripes</b></li> <li>• with <b>QR</b> for fixing at the carrier and holes for the carrier clamp</li> <li>• with <b>handle</b> between the bags</li> </ul> <p><b>top bag:</b></p> <ul style="list-style-type: none"> <li>• size: 34 x 46 x 21 cm, approx. 28 litres</li> <li>• with <b>QR</b> fixed to the side bags</li> <li>• if required a second top bag can be put on top!</li> <li>• all corners are easily accessible through a long rain protected zipper</li> <li>• with <b>attached small parts bag</b>, <b>flexible helmet holder</b> and <b>pocket</b> underneath</li> <li>• can be carried as <b>backpack!</b></li> <li>• with <b>handle</b>, <b>shoulder strap</b> and <b>rear light bracket</b></li> </ul>	<div data-bbox="1177 230 1278 331" style="border: 1px solid black; padding: 2px;"> <p>warenest.org <b>GUT</b> Note: 1.6 M-WAVE Amsterdam Triple 10/2016</p> </div>     
<p><b>122317</b> 8</p>	<p><b>GEPÄCKTRÄGERTASCHE ›AMSTERDAM DOUBLE L‹</b></p> <ul style="list-style-type: none"> <li>• Material: Kunstleder in <b>Echtlederoptik</b></li> <li>• Maße: Gesamtbreite ca. 25 cm</li> <li>• Taschen: je 27,5 x 9 x 33,5 cm (L x B x H)</li> <li>• Volumen ca. 15 Liter</li> <li>• <b>große Hauptfächer</b> mit Metall-schnallen und zusätzlichen <b>Schnellverschlüssen</b></li> <li>• durch Kunststoffböden <b>verstärkt</b></li> <li>• Tragegriff zwischen den Taschen</li> <li>• mit <b>Aussparungen</b> oben zum <b>sicheren Befestigen</b> auf dem Gepäckträger</li> </ul>	<p><b>BICYCLE CARRIER BAG ›AMSTERDAM DOUBLE L‹</b></p> <ul style="list-style-type: none"> <li>• material: imitation leather in <b>genuine leather appearance</b></li> <li>• size: total width approx. 25 cm</li> <li>• bags: each 27.5 x 9 x 33.5 cm (L x W x H)</li> <li>• volume approx. 15 litres</li> <li>• <b>large main compartments</b> with metal buckles and additional <b>quick fasteners</b></li> <li>• <b>reinforced</b> by plastic walls</li> <li>• handle between the bags</li> <li>• <b>slots</b> on the top for <b>safe mounting</b> on the rear carrier</li> </ul>	
<p><b>122210</b> 60</p>	<p><b>OBERRÖHRTASCHE ›ROTTERDAM TOP XL LE‹</b></p> <p>Größe: ca. <b>18,5 x 9,5 x 8,5 cm</b> (L x B x H)</p> <p>Weitere Artikelinformationen auf Seite 38.</p>	<p><b>TOP TUBE BAG ›ROTTERDAM TOP XL LE‹</b></p> <p>size: approx. <b>18.5 x 9.5 x 8.5 cm</b> (L x W x H)</p> <p>More product information on page 38.</p>	

UVP 69,90 €

UVP 41,90 €

UVP 10,90 €

ART.-NR.	BESCHREIBUNG	DESCRIPTION	
  122315  122802  122803  122804  122805  10	<b>GEPÄCKTRÄGERTASCHE ›AMSTERDAM DOUBLE‹</b> <ul style="list-style-type: none"> <li>• Maße: Gesamtbreite ca. 50 cm Taschen: je 34 x 17 x 30 cm (L x B x H)</li> <li>• Volumen ca. 30 Liter</li> <li>• große Hauptfächer mit Schnellverschlüssen</li> <li>• durch Kunststoffböden <b>verstärkt</b></li> <li>• <b>Reflexstreifen</b> und <b>Netz</b> hinten</li> <li>• Tragegriff zwischen den Taschen</li> <li>• mit <b>Aussparungen</b> oben zum <b>sicheren Befestigen</b> auf dem Gepäckträger</li> </ul>	<b>BICYCLE CARRIER BAG ›AMSTERDAM DOUBLE‹</b> <ul style="list-style-type: none"> <li>• size: total width approx. 50 cm bags: each 34 x 17 x 30 cm (L x W x H)</li> <li>• volume approx. 30 litres</li> <li>• large main compartments with QRs</li> <li>• <b>reinforced</b> by plastic walls</li> <li>• <b>reflective stripes and netting</b> on the back</li> <li>• handle between the bags</li> <li>• <b>slots</b> on the top for <b>safe mounting</b> on the rear carrier</li> </ul>	  
122319  100	<b>REGENHAUBE ›AMSTERDAM PROTECT‹</b> <ul style="list-style-type: none"> <li>• <b>universeller</b> Regenschutz</li> <li>• auch passend für Art. 122310/5, 122802-5, ...</li> <li>• mit M-Wave Banderole</li> </ul>	<b>RAIN COVER ›AMSTERDAM PROTECT‹</b> <ul style="list-style-type: none"> <li>• <b>universal</b> rain protection</li> <li>• also suitable for art. 122310/5, 122802-5, ...</li> <li>• with M-Wave banderole</li> </ul>	 
122304  6	<b>SEIDENTASCHE UND TROLLEY ›AMSTERDAM TR S‹</b> <p>Diese Tasche kann als <b>Gepäckträger-tasche</b> und <b>Trolley</b> verwendet werden!</p> <ul style="list-style-type: none"> <li>• Maße: ca. 38 x 20 x 45 cm</li> <li>• großes Hauptfach mit Netztasche, aufgesetzte Außentasche und Trinkflaschenhalter</li> <li>• <b>Teleskop-Zugstange</b></li> <li>• mit <b>3-Punkt Clip-on-Halter</b> für den Gepäckträger (Haken oben = Art. 122889, Haken unten = Art. 122719)</li> <li>• mit Reflektoren</li> <li>• mit 2 Rollen mit <b>Industriekugellager</b> und 2 Abstellfüßen</li> </ul>	<b>CARRIER SINGLE BAG AND TROLLEY ›AMSTERDAM TR S‹</b> <p>This bag is usable as <b>bicycle bag</b> and as a <b>trolley!</b></p> <ul style="list-style-type: none"> <li>• size: approx. 38 x 20 x 45 cm</li> <li>• large main compartment with net pocket, attached outer pocket and bottle holder</li> <li>• <b>telescope drawbar</b></li> <li>• with <b>3-point clip-on bracket</b> for rear carriers (upper hook = art. 122889, lower hook = art. 122719)</li> <li>• with reflectors</li> <li>• with 2 wheels with <b>sealed bearing</b> and 2 stand-on feet</li> </ul>	 <div style="border: 1px solid black; padding: 2px; display: inline-block;">2 in 1</div>  
122320  122321  12	<b>GEPÄCKTRÄGERTASCHE ›AMSTERDAM SINGLE‹</b> <ul style="list-style-type: none"> <li>• Maße: 38 x 18 x 30 cm (L x B x H)</li> <li>• Volumen ca. <b>18 Liter</b></li> <li>• große Tasche mit Schnellverschlüssen</li> <li>• Reflexstreifen und Tragegriff</li> <li>• <b>Schnellbefestigung</b> durch 2 Haken und 1 Spanngummi (Art. 122322)</li> </ul>	<b>BICYCLE CARRIER SINGLE BAG ›AMSTERDAM SINGLE‹</b> <ul style="list-style-type: none"> <li>• size: 38 x 18 x 30 cm (L x W x H)</li> <li>• volumen approx. <b>18 litres</b></li> <li>• large bag with QRs</li> <li>• with reflective stripes and handle</li> <li>• <b>quick mounting</b> through 2 hooks and 1 elastic band (art. 122322)</li> </ul>	 

ART.-NR. 	BESCHREIBUNG	DESCRIPTION	
<p><b>122745</b> 10</p>	<p><b>GEPÄCKTRÄGER-TASCHEN-ORGANIZER</b> ›AMSTERDAM INSERT‹</p> <ul style="list-style-type: none"> <li>• mit gepolstertem <b>Laptopfach</b></li> <li>• Hauptfach durch <b>flexible Trennwände</b> aufteilbar</li> <li>• für Art. 122315, 122320/1 ...</li> <li>• ca. 30 x 14 x 27 cm (L x B x H)</li> <li>• mit M-Wave Karte</li> </ul>	<p><b>ORGANIZER FOR REAR CARRIER BAG</b> ›AMSTERDAM INSERT‹</p> <ul style="list-style-type: none"> <li>• with upholstered <b>laptop compartment</b></li> <li>• main compartment with <b>flexible dividers</b></li> <li>• for art. 122315, 122320/1 ...</li> <li>• approx. 30 x 14 x 27 cm (L x W x H)</li> <li>• with M-Wave tag</li> </ul>	 <p>UVP 13,90 €</p>
<p><b>122318</b> 100</p>	<p><b>DRYBAG</b> ›AMSTERDAM DRY‹</p> <ul style="list-style-type: none"> <li>• <b>100 % wasserdicht</b></li> <li>• universeller Einsatzbereich</li> <li>• <b>Rollverschluss</b> für universelle Größeneinstellung</li> <li>• passend auch als herausnehmbare <b>Innentasche</b> für <b>Gepäckträgertasche</b> (Art. 122320, ...)</li> <li>• Größe ca. 40 x 42 x 16 cm (L x B x H)</li> <li>• auf M-Wave Eurolochkarte</li> </ul>	<p><b>DRYBAG</b> ›AMSTERDAM DRY‹</p> <ul style="list-style-type: none"> <li>• <b>100 % waterproof</b></li> <li>• universal uses</li> <li>• <b>roll cover</b> for individual size adjustment</li> <li>• also suitable as removable <b>inner bag</b> for bicycle <b>carrier bag</b> (art. 122320, ...)</li> <li>• size approx. 40 x 42 x 16 cm (L x W x H)</li> <li>• on M-Wave eurohole card</li> </ul>	 <p>UVP 8,99 €</p> 
<p><b>122312</b> 20</p>	<p><b>GEPÄCKTRÄGERTASCHE</b> ›AMSTERDAM EXP‹</p> <ul style="list-style-type: none"> <li>• großes Hauptfach mit Innentasche</li> <li>• <b>erweiterbar durch zwei große aufklappbare Seitentaschen</b></li> <li>• Volumen ca. 16 Liter</li> <li>• <b>Haltenetz</b> oben</li> <li>• schnelle und einfache Fixierung durch Klettverschlüsse am Gepäckträger</li> <li>• mit <b>Trinkflaschenhalter</b></li> <li>• mit Pumpenhalter</li> <li>• mit Schulterriemen und Reflektoren</li> </ul>	<p><b>BICYCLE CARRIER BAG</b> ›AMSTERDAM EXP‹</p> <ul style="list-style-type: none"> <li>• large main compartment with inner bag</li> <li>• <b>expandable through two large side bags</b></li> <li>• volume approx. 16 litres</li> <li>• <b>attachment net</b> on top</li> <li>• fast and easy velcro attachment to any rear carrier</li> <li>• with <b>bottle holder</b></li> <li>• with bracket for pump</li> <li>• with shoulder straps and reflectors</li> </ul>	 <p>UVP 29,90 €</p>



ART.-NR. 	BESCHREIBUNG	DESCRIPTION	
<b>122384</b> 10	<b>LENKERTASCHE ›UTRECHT FOLD‹</b> <ul style="list-style-type: none"> <li>• platzsparend <b>zusammenfaltbar</b></li> <li>• Größe: 37 x 25 x 25 cm (L x B x H)</li> <li>• Volumen ca. 20 Liter</li> <li>• mit <b>Clip-on</b>-Halter passend für Ø 22,2 bis <b>31,8 mm</b></li> <li>• stabiler <b>Rahmen</b> + feste <b>Bodenplatte</b> mit Abstellfüßen</li> <li>• <b>2 Tragegurte</b> zum Zusammenkletten</li> <li>• <b>Außentasche</b> mit Reißverschluss</li> <li>• mit <b>Regenschutz</b></li> <li>• mit Reflexlogo</li> <li>• mit M-Wave Banderole</li> </ul>	<b>HANDLEBAR BAG ›UTRECHT FOLD‹</b> <ul style="list-style-type: none"> <li>• space savingly <b>foldable</b></li> <li>• size: 37 x 25 x 25 cm (L x W x H)</li> <li>• volume approx. 20 litres</li> <li>• with <b>clip-on</b> bracket for Ø 22.2 up to <b>31.8 mm</b></li> <li>• stable <b>frame</b> and robust <b>floor plate</b> with stand-on feet</li> <li>• <b>2 carrying straps</b> (can be tied up)</li> <li>• <b>outer pocket</b> with zipper</li> <li>• with <b>rain shelter</b></li> <li>• with reflective logo</li> <li>• with M-Wave banderole</li> </ul> <p style="text-align: right;">UVP 34,90 €</p>	 <p>22,2 - 31,8 mm</p> <p>FOLD</p>
<b>122385</b> 20	<b>LENKERTASCHE ›UTRECHT TRAVEL‹</b> <ul style="list-style-type: none"> <li>• mit <b>Clip-on</b>-Halter (Art. 431523) passend für Ø <b>22,2 bis 31,8 mm</b></li> <li>• Volumen ca. 10 Liter</li> <li>• <b>2 Zusatztaschen</b> und ein <b>isolierter Flaschenhalter</b></li> <li>• <b>Klarsichtfenster</b> für Landkarten</li> <li>• Trage-/Schulterriemen</li> <li>• Reflexstreifen</li> </ul>	<b>HANDLEBAR BAG ›UTRECHT TRAVEL‹</b> <ul style="list-style-type: none"> <li>• with <b>clip-on</b> bracket (art. 431523) for Ø <b>22.2 up to 31.8 mm</b></li> <li>• volume approx. 10 litres</li> <li>• <b>2 additional bags</b> and one <b>insulated bottle holder</b></li> <li>• <b>window pocket</b> for maps</li> <li>• carrying-/shoulder strap</li> <li>• reflective stripes</li> </ul> <p style="text-align: right;">UVP 30,90 €</p>	
<b>122819</b> 50	<b>LENKERTASCHE ›UTRECHT TRAVEL ECO‹</b> <ul style="list-style-type: none"> <li>• Befestigung mit zwei <b>universell versetzbaren</b> Klettverschlüssen an <b>Rollern, Fahrrädern, ...</b></li> <li>• innen mit zusätzlicher Versteifung</li> <li>• mit Reflexaufdruck</li> <li>• Größe ca. 22 x 10 x 16 cm (L x B x H)</li> </ul>	<b>HANDLEBAR BAG ›UTRECHT TRAVEL ECO‹</b> <ul style="list-style-type: none"> <li>• mounting with two <b>universally displaceable</b> hook and loop fasteners on <b>scooters, bicycles, ...</b></li> <li>• additional internal stiffness</li> <li>• with reflective print</li> <li>• size approx. 22 x 10 x 16 cm (L x W x H)</li> </ul> <p style="text-align: right;">UVP 9,90 €</p>	 
<b>122342</b> 50	<b>LENKERTASCHE ›AMSTERDAM BOTTLE ISO‹</b> <ul style="list-style-type: none"> <li>• mit <b>isolierender Innenschicht</b></li> <li>• <b>universelle, werkzeuglose</b> Anbringung am Lenker, Vorbau, Rahmenrohr, ...</li> <li>• rutschsichere Klettbefestigung</li> <li>• universelle Einsatzbereiche z. B. für Trinkflaschen, Werkzeuge, ...</li> <li>• mit Reflexlogo</li> <li>• mit Kordelzugverschluss</li> </ul>	<b>HANDLEBAR BAG ›AMSTERDAM BOTTLE ISO‹</b> <ul style="list-style-type: none"> <li>• with <b>insulating inner layer</b></li> <li>• <b>universal, toolless</b> mounting on the handlebar, handle stem, frame tube, ...</li> <li>• non-slip hook and loop straps</li> <li>• universal applications e. g. for water bottles, tools, ...</li> <li>• with reflective logo</li> <li>• with drawstring fastener</li> </ul> <p style="text-align: right;">UVP 8,90 €</p>	  <p>ISOLATION</p>   

ART.-NR. 	BESCHREIBUNG	DESCRIPTION	
<b>122396</b> 100	<b>SMARTPHONE TASCHЕ</b> <b>›EINDHOVEN SC 1‹</b> <ul style="list-style-type: none"> <li>• Handy durch großes, transparentes Sichtfenster <b>bedienbar</b></li> <li>• erschütterungsabsorbierende, weiche <b>Polstereinlage</b></li> <li>• wasserabweisend</li> <li>• passend für alle gängigen iPhones und Smartphones, z. B. iPhone 12 Pro Max</li> <li>• Größe: ca. 180 x 85 x 30 mm (L x B x H)</li> <li>• <b>drehbarer Clip-on-Halter</b> für Ø 22,0 bis 40 mm</li> <li>• auf M-Wave Eurolochkarte</li> </ul>	<b>SMARTPHONE BAG</b> <b>›EINDHOVEN SC 1‹</b> <ul style="list-style-type: none"> <li>• mobile phone <b>operable</b> through large, transparent screen</li> <li>• shock absorbing, soft <b>padding</b></li> <li>• water-repellent</li> <li>• suitable for all popular iPhones and smartphones, e. g. iPhone 12 Pro Max</li> <li>• size: approx. 180 x 85 x 30 mm (L x W x H)</li> <li>• <b>turnable clip-on</b> bracket for Ø 22.0 up to 40 mm</li> <li>• on M-Wave eurohole card UVP 14,90 €</li> </ul>	
<b>122584</b> 125	<b>SMARTPHONEHALTER</b> <b>›BIKE MOUNT AL‹</b> <ul style="list-style-type: none"> <li>• <b>Aluminium</b></li> <li>• <b>90° drehbare Lenkerhalterung</b> für Ø 22,2 - 31,8 mm</li> <li>• <b>stufenlos einstellbar</b> von 60 - 95 mm</li> <li>• inkl. Softpads zum Schutz des Smartphones</li> <li>• in M-Wave Eurolochbox</li> </ul>	<b>SMARTPHONE BRACKET</b> <b>›BIKE MOUNT AL‹</b> <ul style="list-style-type: none"> <li>• <b>aluminium</b></li> <li>• <b>90° turnable bracket</b> up to Ø 22.2 - 31.8 mm</li> <li>• <b>infinitely adjustable</b> up to 60 - 95 mm</li> <li>• incl. Softpads to protect the smartphone</li> <li>• in M-Wave eurohole box UVP 14,90 €</li> </ul>	
<b>122580</b> 132	<b>HALTER FÜR MOBILE ENDGERÄTE</b> <b>›BIKE MOUNT FLEX‹</b> <ul style="list-style-type: none"> <li>• <b>universelle 360° drehbare</b> Halterung</li> <li>• universell passend für ca. <b>3,5" - 6,5" Displaygröße</b></li> <li>• aus <b>elastischem, rutschhemmendem Silikon</b></li> <li>• schnelle werkzeuglose Montage am Lenker, Vorbau, ... durch Silikonhalter</li> <li>• in M-Wave Eurolochbox</li> </ul>	<b>BRACKET FOR MOBILE DEVICES</b> <b>›BIKE MOUNT FLEX‹</b> <ul style="list-style-type: none"> <li>• <b>universal 360° turnable</b> bracket</li> <li>• universally suitable for approx. <b>3.5" - 6.5" display size</b></li> <li>• made of <b>elastic, non-slip silicone</b></li> <li>• quick, toolless mounting to the handlebar, handle stem, ... by silicone bracket</li> <li>• in M-Wave eurohole box</li> </ul> <p style="text-align: right;">UVP 11,90 €</p>	
<b>122405</b> 50	<b>SMARTPHONE HALTER</b> <b>›EINDHOVEN GRIP‹</b> <ul style="list-style-type: none"> <li>• erschütterungsabsorbierende, weiche <b>Polstereinlage</b></li> <li>• <b>werkzeuglos</b> verstellbare Auflagefläche</li> <li>• passend für fast alle gängigen iPhones und Smartphones</li> <li>• Auflagefläche: ca. 110 x 55 x 11 mm bis 126 x 72 x 11 mm (L x B x H)</li> <li>• <b>360° stufenlos drehbarer Clip-on-Halter</b> für Ø 21 bis 32 mm, <b>werkzeuglose</b> Montage</li> <li>• auf M-Wave Eurolochkarte</li> </ul>	<b>SMARTPHONE BRACKET</b> <b>›EINDHOVEN GRIP‹</b> <ul style="list-style-type: none"> <li>• shock absorbing, soft <b>padding</b></li> <li>• <b>toolless</b> adjustable contact area</li> <li>• suitable for almost all iPhones and smartphones</li> <li>• contact area: approx. 110 x 55 x 11 mm up to 126 x 72 x 11 mm (L x W x H)</li> <li>• <b>360° steplessly turnable clip-on</b> bracket for Ø 21 up to 32 mm, <b>toolless</b> mounting</li> <li>• on M-Wave eurohole card</li> </ul> <p style="text-align: right;">UVP 8,90 €</p>	
<b>122411</b> 100	<b>HALTER FÜR MOBILE ENDGERÄTE</b> <b>›EINDHOVEN GRIP EDGE‹</b> <ul style="list-style-type: none"> <li>• aus stabilem ABS-Kunststoff</li> <li>• <b>universelle</b> Größenanpassung (55 x 116 x 12 mm bis 90 x 180 x 12 mm)</li> <li>• passend für viele mobile Endgeräte</li> <li>• <b>360° drehbar</b>, mit Fixierfunktion</li> <li>• mit Moosgummi-Einlage zur individuellen Anpassung und Stoßabsorption</li> <li>• für Lenkerdurchmesser 22,2 - 31,8 mm</li> <li>• <b>werkzeuglos</b> montierbar</li> <li>• in M-Wave Eurolochbox</li> </ul>	<b>BRACKET FOR MOBILE DEVICES</b> <b>›EINDHOVEN GRIP EDGE‹</b> <ul style="list-style-type: none"> <li>• made of stable ABS plastic</li> <li>• <b>universal</b> size adjustment (55 x 116 x 12 mm to 90 x 180 x 12 mm)</li> <li>• suitable for many mobile devices</li> <li>• <b>360° turnable</b>, with fixing function</li> <li>• with foam rubber inlay for individual size adaptation and shock absorption</li> <li>• for handlebar diameter 22.2 - 31.8 mm</li> <li>• <b>toolless</b> mounting</li> <li>• in M-Wave eurohole box</li> </ul> <p style="text-align: right;">UVP 9,90 €</p>	

ART.-NR.	BESCHREIBUNG	DESCRIPTION	
	<b>M-WAVE SMART SCHALEN – GARANTIERT SICHER!</b> <ul style="list-style-type: none"> <li>• viele <b>Kombinationsmöglichkeiten</b> von Haltern und Hüllen</li> <li>• verschiedene <b>Montagepositionen für optimale Sicht</b> auf Ihr Smartphone</li> <li>• in <b>Deutschland produziert</b></li> </ul>	<b>M-WAVE SMART SHELLS – GUARANTEED SAFE!</b> <ul style="list-style-type: none"> <li>• a lot of <b>potential combinations</b> of brackets and shells</li> <li>• various <b>mounting positions for an optimized view</b> to your smartphone</li> <li>• <b>made in Germany</b></li> </ul>	<div style="border: 1px solid black; padding: 2px; display: inline-block;">MADE IN GERMANY</div> 
<b>122576</b> 20 <b>122699</b> 120	<b>ADAPTER FÜR GARMIN</b> <ul style="list-style-type: none"> <li>• für <b>4QuickFix</b>-Systeme</li> <li>• Adapter für <b>Garmin</b> eTrex, DakotaTM, Oregon, Approach, Astro, GPSMAP (kein original Garmin Ersatzteil)</li> </ul> auf M-Wave Eurolochkarte Montageverpackung	<b>ADAPTER FOR GARMIN</b> <ul style="list-style-type: none"> <li>• for <b>4QuickFix</b> systems</li> <li>• adapter for <b>Garmin</b> eTrex, DakotaTM, Oregon, Approach, Astro, GPSMAP (no original Garmin spare part)</li> </ul> on M-Wave eurohole card OEM UVP 9,90 €	 
<b>122569</b> 20 <b>122693</b> 20	<b>HALTER FÜR NAVIGATIONS-GERÄTE ›AUTO NAVI FIX‹</b> <ul style="list-style-type: none"> <li>• passend für viele <b>Automobil-Navigationsgeräte</b> (z. B. von TomTom, Becker, Magellan, Garmin, Blaupunkt, Navman, Medion, Navigon, Falk, VDO/Dayton, ...)</li> <li>• mit <b>4QuickFix</b>-Aufnahme</li> <li>• für Geräte von <b>59 bis 89 mm Höhe</b></li> <li>• <b>bewegliche Stützstege</b></li> </ul> auf M-Wave Eurolochkarte Montageverpackung	<b>BRACKET FOR NAVIGATION SYSTEMS ›AUTO NAVI FIX‹</b> <ul style="list-style-type: none"> <li>• suitable for many <b>car navigation systems</b> (e.g. by TomTom, Becker, Magellan, Garmin, Blaupunkt, Navman, Medion, Navigon, Falk, VDO/Dayton, ...)</li> <li>• with <b>4QuickFix</b> receiver</li> <li>• for gadgets from <b>59 to 89 mm height</b></li> <li>• <b>movable support rods</b></li> </ul> on M-Wave eurohole card OEM UVP 15,90 €	<div style="border: 1px solid black; padding: 2px; display: inline-block;">AUTO</div>  <div style="display: flex; align-items: center;"> <div style="writing-mode: vertical-rl; transform: rotate(180deg); font-size: 8px; margin-right: 5px;">59 - 89 mm</div>  </div>
<b>122691</b> 60	<b>SMARTPHONE HARTSCHALE ›BIKE MOUNT HC M‹</b> <ul style="list-style-type: none"> <li>• <b>spritzwassergeschützt</b></li> <li>• <b>touch sensitive Folie</b> mit <b>Entspiegelungsfunktion</b></li> <li>• für Smartphones bis <b>145 x 78 x 13,4 mm</b> (z. B. für Galaxy S6, Galaxy S6 Edge, iPhone 6S, P8, iPhone 11 Pro, iPhone SE, Xperia Z, ...)</li> <li>• <b>Kabeldurchführung für Kopfhörer</b> und <b>Ladekabel</b></li> <li>• <b>schlagfestes, witterungsbeständiges</b> und <b>rutschfestes</b> Material</li> <li>• mit <b>4QuickFix</b>-Aufnahme</li> <li>• <b>90° drehbar</b></li> <li>• Montageverpackung</li> </ul>	<b>SMARTPHONE HARD CASE ›BIKE MOUNT HC M‹</b> <ul style="list-style-type: none"> <li>• <b>water protected</b></li> <li>• <b>touch sensitive window</b> with <b>anti-reflection</b> function</li> <li>• For smartphones to <b>145 x 78 x 13.4 mm</b> (e. g. for Galaxy S6, Galaxy S6 Edge, iPhone 6S, P8, iPhone 11 Pro, iPhone SE, Xperia Z, ...)</li> <li>• <b>cable lead through for earphones</b> and <b>charging cables</b></li> <li>• <b>impact resistant, weatherproof</b> and <b>non-slip material</b></li> <li>• with <b>4QuickFix</b> receiver</li> <li>• <b>90° turnable</b></li> <li>• OEM</li> </ul> UVP 16,90 €	<div style="border: 1px solid black; padding: 2px; display: inline-block;">M</div>  
<b>122215</b> 40 <b>NEW</b>	<b>OBERROHRTASCHE ›ROTTERDAM TOP XL SC‹</b> <ul style="list-style-type: none"> <li>• mit <b>Blendschutz für bessere Sichtbarkeit</b> des Smartphonesdisplays</li> <li>• sichere Befestigung mit Klettverschlüssen</li> <li>• Touchdisplay durch <b>wassergeschütztes, transparentes Sichtfenster</b> bedienbar</li> <li>• Reflektoren an den Seiten</li> <li>• zusätzlich mit universeller Regenschutzhaube</li> <li>• Größe: ca. 18,5 x 9,5 x 8,5 mm (L x B x H)</li> </ul>	<b>TOP TUBE BAG ›ROTTERDAM TOP XL SC‹</b> <ul style="list-style-type: none"> <li>• with <b>glare protection for better visibility</b> of the smartphone display</li> <li>• secure mounting with hook and loop fasteners</li> <li>• touchpad usable through <b>water protected, transparent top window pocket</b></li> <li>• reflective stripes on the sides</li> <li>• additionally with universal rain cover</li> <li>• size: approx. 18.5 x 9.5 x 8.5 mm (L x W x H)</li> </ul> UVP 19,90 €	 <div style="border: 1px solid black; padding: 2px; display: inline-block; font-size: 8px;">   water resistant </div> 





ART.-NR. 	BESCHREIBUNG	DESCRIPTION	
<b>122376</b> 50	<b>OBERROHRTASCHE ›ROTTERDAM TOP SB‹</b> <ul style="list-style-type: none"> <li>• sichere Befestigung mit 3 Klettverschlüssen</li> <li>• verstärkter Boden</li> <li>• erschütterungsabsorbierende, weiche <b>Polstereinlage</b></li> <li>• wasserabweisendes Material und Reißverschlüsse</li> <li>• großes Hauptfach, durch Netz unterteilt</li> <li>• <b>zwei ausklappbare, erweiterbare Seitentaschen</b></li> <li>• Toptasche mit zwei Innenfächern für <b>iPhone, Smartphone</b>, GPS-Geräte, ...</li> <li>• Touchdisplay durch <b>wassergeschütztes, transparentes Sichtfenster</b> bedienbar</li> <li>• Größe: ca. 18,5 x 11 x 13 cm (L x B x H), zusätzliche Seitentaschen ausgeklappt ca. 12 x 14 x 3 cm</li> </ul>	<b>TOP TUBE BAG ›ROTTERDAM TOP SB‹</b> <ul style="list-style-type: none"> <li>• secure mounting with 3 hook and loop fasteners</li> <li>• reinforced bottom</li> <li>• shock absorbing soft <b>padding</b></li> <li>• water-repellent material and zipper</li> <li>• large main compartment, separated inside by a net</li> <li>• <b>two foldable, extendable side bags</b></li> <li>• top pocket with two inner pockets for <b>iPhone, smartphone</b>, GPS device, ...</li> <li>• touchpad usable through <b>water protected, transparent top window pocket</b></li> <li>• size: approx. 18.5 x 11 x 13 cm (L x W x H), additional extended side pockets approx. 12 x 14 x 3 cm</li> </ul> <p style="text-align: right;">UVP 14,90 €</p>	<div style="text-align: right;"><b>XXL</b></div> 
<b>122377</b> 50	<b>OBERROHRTASCHE ›ROTTERDAM TOP SOUND‹</b> <ul style="list-style-type: none"> <li>• mit <b>integriertem Lautsprecher</b></li> <li>• Anschluss passend für <b>Smartphones, iPhones, iPods, MP3-Player</b> (3,5 mm Klinkenstecker)</li> <li>• sichere Befestigung mit 3 Klettverschlüssen</li> <li>• verstärkter Boden</li> <li>• erschütterungsabsorbierende, weiche <b>Polstereinlage</b></li> <li>• wasserabweisendes Material und Reißverschlüsse</li> <li>• Touchdisplay durch <b>wassergeschütztes, transparentes Sichtfenster</b> bedienbar</li> <li>• passend für <b>große iPhones und Smartphones</b></li> <li>• Größe: ca. 18 x 9 x 9 cm (L x B x H)</li> </ul>	<b>TOP TUBE BAG ›ROTTERDAM TOP SOUND‹</b> <ul style="list-style-type: none"> <li>• with <b>integrated speaker</b></li> <li>• port suitable for <b>smartphones, iPhones, iPods, MP3 player</b> (3.5 mm stereo jack)</li> <li>• secure mounting with 3 hook and loop fasteners</li> <li>• reinforced bottom</li> <li>• shock absorbing, soft <b>padding</b></li> <li>• water-repellent material and zipper</li> <li>• touchpad usable through <b>water protected, transparent top window pocket</b></li> <li>• suitable for <b>bigger iPhones and smartphones</b></li> <li>• size: approx. 18 x 9 x 9 cm (L x W x H)</li> </ul> <p style="text-align: right;">UVP 15,90 €</p>	<div style="text-align: right;"><b>XL</b></div> 
<b>122372</b>          <b>122210</b> 60	<b>OBERROHRTASCHE ›ROTTERDAM TOP XL‹</b> <ul style="list-style-type: none"> <li>• sichere Befestigung mit 3 Klettverschlüssen</li> <li>• verstärkter Boden</li> <li>• erschütterungsabsorbierende, weiche <b>Polstereinlage</b></li> <li>• wasserabweisendes Material und Reißverschlüsse</li> <li>• Touchdisplay durch <b>wassergeschütztes, transparentes Sichtfenster</b> bedienbar</li> <li>• Reflektoren an den Seiten</li> <li>• passend für große <b>Smartphones</b>, wie z. B. iPhone X</li> <li>• Größe: <b>ca. 18,5 x 9,5 x 8,5 cm</b> (L x B x H)</li> </ul>  schwarz	<b>TOP TUBE BAG ›ROTTERDAM TOP XL‹</b> <ul style="list-style-type: none"> <li>• secure mounting with 3 hook and loop fasteners</li> <li>• reinforced bottom</li> <li>• shock absorbing, soft <b>padding</b></li> <li>• water-repellent material and zipper</li> <li>• touchpad usable through <b>water protected, transparent top window pocket</b></li> <li>• reflective stripes on the sides</li> <li>• suitable for bigger <b>Smartphones</b> like e. g. iPhone X</li> <li>• size: <b>approx. 18.5 x 9.5 x 8.5 cm</b> (L x W x H)</li> </ul>  black	<div style="text-align: right;"><b>XL</b></div>  <p>185 mm 95 mm</p> <p style="text-align: right;">UVP 8,90 €</p> <p style="text-align: right;">UVP 10,90 €</p>

ART.-NR.	BESCHREIBUNG	DESCRIPTION	
<p><b>122375</b></p> <p><b>122552</b></p> <p><b>122553</b></p> <p><b>122554</b></p> <p><b>122555</b></p> <p><b>122556</b></p> <p><b>122557</b></p> <p><b>122558</b></p> <p>60</p>	<p><b>OBERROHRTASCHE</b> ›ROTTERDAM TOP L‹</p> <ul style="list-style-type: none"> <li>• sichere Befestigung mit 3 Klettverschlüssen</li> <li>• verstärkter Boden</li> <li>• erschütterungsabsorbierende, weiche <b>Polstereinlage</b></li> <li>• wasserabweisendes Material und Reißverschlüsse</li> <li>• Touchdisplay durch <b>wassergeschütztes, transparentes Sichtfenster</b> bedienbar</li> <li>• Reflektoren an den Seiten</li> <li>• passend für <b>Smartphones</b></li> <li>• Größe: ca. 17,5 x 8 x 8,5 cm (L x B x H)</li> </ul>	<p><b>TOP TUBE BAG</b> ›ROTTERDAM TOP L‹</p> <ul style="list-style-type: none"> <li>• secure mounting with 3 hook and loop fasteners</li> <li>• reinforced bottom</li> <li>• shock absorbing, soft <b>padding</b></li> <li>• water-repellent material and zipper</li> <li>• touchpad usable through <b>water protected, transparent top window pocket</b></li> <li>• reflective stripes on the sides</li> <li>• suitable for <b>smartphones</b></li> <li>• size: approx. 17.5 x 8 x 8.5 cm (L x W x H)</li> </ul> <p>black</p> <p>white</p> <p>red</p> <p>blue</p> <p>green</p> <p>yellow</p> <p>orange</p> <p>pink</p> <p>UVP 6,90 €</p>	
<p><b>122366</b></p> <p>100</p>	<p><b>DREIECKSTASCHE</b> ›ROTTERDAM TRI‹</p> <ul style="list-style-type: none"> <li>• Befestigung mit 3 Klettverschlüssen</li> <li>• <b>Reflektoren</b> an den Seiten</li> <li>• mit <b>Polsterung</b> zum leichten Tragen des Fahrrads</li> </ul>	<p><b>TRIANGLE BAG</b> ›ROTTERDAM TRI‹</p> <ul style="list-style-type: none"> <li>• fixation with 3 hook and loop fasteners</li> <li>• <b>reflective stripes</b> on the sides</li> <li>• with <b>soft padding</b> for easy carrying the bike</li> </ul> <p>UVP 5,90 €</p>	
<p><b>122830</b></p> <p>100</p>	<p><b>FLASCHENHALTER-TASCHE</b> ›GRONINGEN BC‹</p> <ul style="list-style-type: none"> <li>• inkl. <b>Aluminium-Adapter</b> zur Befestigung an den Flaschenhalterösen (unter dem Flaschenhalter)</li> <li>• <b>wasserdicht</b></li> <li>• mit Innentasche für z. B. Kettenverschlussglieder, ...</li> <li>• Tasche kann leicht (de-)montiert werden</li> <li>• Adapter kann auch nur mit Klettbindern (z. B. Art. 340042) genutzt werden</li> <li>• Größe: ca. 11,0 x 7,5 x 6,5 cm (L x B x H)</li> <li>• auf M-Wave Eurolochkarte</li> </ul>	<p><b>BOTTLE CAGE BAG</b> ›GRONINGEN BC‹</p> <ul style="list-style-type: none"> <li>• incl. <b>aluminium adapter</b> for mounting to the bottle cage eyelets (below the bottle cage)</li> <li>• <b>waterproof</b></li> <li>• with inner bag for e. g. chain links, ...</li> <li>• bag can easily be (de-)mounted</li> <li>• bracket can also be used only with hook and loop straps (e. g. art. 340042)</li> <li>• size: approx. 11.0 x 7.5 x 6.5 cm (L x W x H)</li> <li>• on M-Wave eurohole card</li> </ul> <p>UVP 13,90 €</p>	

ART.-NR.	BESCHREIBUNG	DESCRIPTION	
<b>122831</b> 40	<b>SATTEL TASCH E</b> <b>›AMSTERDAM BOTTLE‹</b> <ul style="list-style-type: none"> <li>• geräumiges Hauptfach mit großer Öffnung</li> <li>• mit <b>Trinkflaschenhalterfach</b></li> <li>• sichere Befestigung mit vier <b>universell anpassbaren</b> Klettverschlüssen</li> <li>• mit <b>Rücklichthalterschlaufe</b></li> <li>• mit <b>Reflexaufdruck</b></li> <li>• Größe ca. 9,5 x 10 x 27 cm (L x B x H)</li> <li>• mit M-Wave Anhänger</li> </ul>	<b>SADDLE BAG</b> <b>›AMSTERDAM BOTTLE‹</b> <ul style="list-style-type: none"> <li>• <b>spacious</b> main compartment with large opening</li> <li>• with <b>bottle holder pocket</b></li> <li>• secure mounting with four <b>universally adjustable</b> hook and loop fasteners</li> <li>• with <b>rear light bracket strap</b></li> <li>• with <b>reflective print</b></li> <li>• size approx. 9.5 x 10 x 27 cm (L x W x H)</li> <li>• with M-Wave tag</li> </ul>	   <p>UVP 13,90 €</p>
<b>122339</b> 60	<b>SATTEL TASCH E</b> <b>›TILBURG L ILLU‹</b> <ul style="list-style-type: none"> <li>• mit <b>integriertem LED-Ringlicht</b>, aufladbar über <b>USB-Kabel</b> (inkl.)</li> <li>• einfache, werkzeuglose Montage mit T-Halter für Sattelgestell und Klettverschluss für Sattelstütze</li> <li>• durch Reißverschluss nach unten <b>erweiterbar</b></li> <li>• mit <b>Haltenetz</b> unten (z. B. für Luftpumpe)</li> <li>• mit Reflexaufdruck</li> <li>• Größe: ca. 180 x 115 mm</li> <li>• Höhe: ca. 105 - 180 mm</li> <li>• auf M-Wave Eurolochkarte</li> </ul> <p>Ohne deutsches Prüfzeichen - Verkauf und Nutzung im Geltungsbereich der StVZO (Deutschland) unzulässig (Abgabe nur an außerdeutsche Kunden).</p>	<b>SADDLE BAG</b> <b>›TILBURG L ILLU‹</b> <ul style="list-style-type: none"> <li>• with <b>integrated LED light</b>, rechargeable by <b>USB cable</b> (incl.)</li> <li>• easy, toolless mounting with T-bar for saddle rail and hook and loop strap for seat post</li> <li>• through zipper <b>expandable</b> at the bottom</li> <li>• with <b>mesh net</b> at the bottom (e. g. for pump)</li> <li>• with reflective print</li> <li>• size: approx. 180 x 115 mm</li> <li>• height: approx. 105 - 180 mm</li> <li>• on M-Wave eurohole card</li> </ul>	    <p>UVP 19,90 €</p>
<b>122360</b> <b>122482</b> <b>122483</b> <b>122484</b> <b>122485</b> <b>122488</b> 40	<b>SATTEL TASCH E</b> <b>›TILBURG L‹</b> <ul style="list-style-type: none"> <li>• mit Clip-on-Halter (Art. 122299)</li> <li>• durch Reißverschluss nach unten <b>erweiterbar</b></li> <li>• mit <b>Rücklichthalter</b> und <b>Klettströmen</b> unten (z. B. für Luftpumpe)</li> <li>• mit Reflexaufdruck</li> <li>• Größe: ca. 180 x 115 mm</li> <li>• Höhe: ca. 105 - 180 mm</li> </ul>	<b>SADDLE BAG</b> <b>›TILBURG L‹</b> <ul style="list-style-type: none"> <li>• with clip-on bracket (art. 122299)</li> <li>• through zipper <b>expandable</b> at the bottom</li> <li>• with <b>light bracket</b> and <b>hook and loop fasteners</b> at the bottom (e. g. for pump)</li> <li>• with reflective print</li> <li>• size: approx. 180 x 115 mm</li> <li>• height: approx. 105 - 180 mm</li> </ul>	      <p>UVP 6,90 €</p>
<b>122357</b> 100	<b>SATTEL TASCH E</b> <b>›TILBURG M‹</b> <ul style="list-style-type: none"> <li>• Größe: ca. 187 x 60 mm</li> <li>• Höhe: ca. 95 - 150 mm</li> </ul>	<b>SADDLE BAG</b> <b>›TILBURG M‹</b> <ul style="list-style-type: none"> <li>• size: approx. 187 x 60 mm</li> <li>• height: approx. 95 - 150 mm</li> </ul>	 <p>UVP 6,90 €</p>
<b>122356</b> 100	<b>SATTEL TASCH E</b> <b>›TILBURG S‹</b> <ul style="list-style-type: none"> <li>• Befestigung mit Riemen und Klettverschlüssen</li> <li>• mit <b>Reflexstreifen</b> (als <b>Lichthalter</b> verwendbar)</li> </ul>	<b>SADDLE BAG</b> <b>›TILBURG S‹</b> <ul style="list-style-type: none"> <li>• attachment with straps and hook and loop fasteners</li> <li>• with <b>reflective stripe</b> (useable as <b>light bracket</b>)</li> </ul>	 <p>UVP 4,90 €</p>





ART.-NR.	BESCHREIBUNG	DESCRIPTION	
122529 10	<b>LAUFRADTASCHE ›ROTTERDAM WSB DOUBLE‹</b> <ul style="list-style-type: none"> <li>für <b>2 Laufräder bis 29"</b></li> <li>Tasche durch Reißverschluss <b>in zwei Einzelaschen unterteilbar</b> (auch einzeln verwendbar)</li> <li>Durchmesser 76 cm</li> <li><b>gepolstert</b></li> <li>inkl. <b>Schutzscheiben</b> für die Naben</li> <li><b>Innentasche</b> für Schnellspanner</li> <li>mit Tragegriff und <b>Schultergurt</b></li> <li>mit beschriftbarem <b>Namensanhänger</b></li> </ul>	<b>WHEEL BAG ›ROTTERDAM WSB DOUBLE‹</b> <ul style="list-style-type: none"> <li>for <b>2 wheels up to 29"</b></li> <li>zippered bag <b>dividable into two single bags</b> (can also be used separately)</li> <li>diameter 76 cm</li> <li><b>padded</b></li> <li>incl. <b>protection discs</b> for the hubs</li> <li><b>inner pocket</b> for the QRs</li> <li>with handle and <b>shoulder strap</b></li> <li>with inscribable <b>name tag</b></li> </ul>	<div style="border: 1px solid black; padding: 2px; display: inline-block;">             ✓ 2x 29" ✓ 4x 700 C           </div> 
122533	<b>LAUFRADTASCHE ›ROTTERDAM WSB‹</b> <ul style="list-style-type: none"> <li><b>gepolstert</b></li> <li>inkl. <b>2 Schutzscheiben</b> für die Naben</li> <li><b>Innentasche</b> für Schnellspanner</li> <li>mit Tragegriff</li> </ul>	<b>WHEEL BAG ›ROTTERDAM WSB‹</b> <ul style="list-style-type: none"> <li><b>padded</b></li> <li>incl. <b>2 protection discs</b> for the hubs</li> <li><b>inner pocket</b> for the QRs</li> <li>with handle</li> </ul>	
122530 20	Durchmesser 83 cm, für Räder <b>bis 29"</b> und besonders breite 26" Laufräder	diameter 83 cm, for wheels <b>up to 29"</b> and extra wide 26" wheels	UVP 26,90 €
122530 20	Durchmesser 76 cm, für Räder <b>bis 28"</b>	diameter 76 cm, for wheels <b>up to 28"</b>	UVP 21,90 €
122400 100	<b>ANTRIEBSSCHUTZTASCHE ›ROTTERDAM PROTECT‹</b> <ul style="list-style-type: none"> <li>optimaler Schutz für die Fahrrad- triebseinheit im <b>Auto, Flugzeug, ...</b></li> <li><b>Schmutzschutz</b> auf dem <b>Fahrrad- träger</b></li> <li>passend für alle gängigen Kombi- nationen von Kettenradgarnituren, Umwerfern, Kassetten, Schaltwerk, ...</li> <li>auf M-Wave Eurolochkarte</li> </ul>	<b>DRIVE UNIT PROTECTION BAG ›ROTTERDAM PROTECT‹</b> <ul style="list-style-type: none"> <li>optimum drive unit protection during transport in <b>cars, aeroplanes, ...</b></li> <li><b>dirt protection</b> during transport on a <b>car bike carrier</b></li> <li>fits for all usual combinations of crank- sets, front derailleurs, cassettes, rear derailleurs, ...</li> <li>on M-Wave eurohole card</li> </ul>	 
122900 150/5 pair	<b>PEDALTASCHE ›ROTTERDAM PEDAL P‹</b> <ul style="list-style-type: none"> <li><b>2 Taschen für 1 Paar Pedale</b></li> <li>aus Neopren</li> <li>als <b>Transporttaschen oder zum Schutz am Rad</b> verwendbar</li> <li>ca. 135 x 145 mm</li> <li>1 Paar auf M-Wave Eurolochkarte</li> </ul>	<b>PEDAL BAG ›ROTTERDAM PEDAL P‹</b> <ul style="list-style-type: none"> <li><b>2 bags for 1 pair of pedals</b></li> <li>made of neoprene</li> <li>suitable as <b>transport bags or as protection on the bike</b></li> <li>approx. 135 x 145 mm</li> <li>1 pair on M-Wave eurohole card</li> </ul>	 
122795 1	<b>FAHRRADKOFFER ›ROTTERDAM BIG BOX‹</b> <ul style="list-style-type: none"> <li>sehr <b>robuste Ausführung</b></li> <li>innen <b>gepolstert</b></li> <li><b>abschließbar</b></li> <li>mit seitlichen Verschlüssen (Art. 122796)</li> <li>mit <b>2 Laufradtaschen</b></li> <li>mit <b>Werkzeugtasche</b></li> <li>Größe: ca. 110/100 x 29 x 79/75 cm (L x B x H)</li> <li>mit 2 integrierten/geschützten Rollen hinten (Art. 122797)</li> <li>mit 2 lenk-/drehbaren Rollen vorne (Art. 122798)</li> <li>inkl. Zieh- und Tragegriff</li> </ul>	<b>BIKE CASE ›ROTTERDAM BIG BOX‹</b> <ul style="list-style-type: none"> <li>pretty <b>robust design</b></li> <li>inner <b>foam padding</b></li> <li><b>lockable</b></li> <li>with replacement lock (art. 122796)</li> <li>with <b>2 wheel bags</b></li> <li>with <b>tool pocket</b></li> <li>size approx. 110/100 x 29 x 79/75 cm (L x W x H)</li> <li>with 2 integrated/protected pulleys at the back (art. 122797)</li> <li>with 2 front pulleys, dirigible and turnable (art. 122798)</li> <li>incl. pulling and carrying handle</li> </ul>	 <div style="border: 1px solid black; padding: 2px; display: inline-block;">             INTEGRATED           </div>
			UVP 439,00 €

ART.-NR.	BESCHREIBUNG	DESCRIPTION	
<p></p> <p><b>BIKER SPEZIAL-RUCKSACK ›BP BACK‹</b></p> <ul style="list-style-type: none"> <li>• <b>gepolsterte, atmungsaktive Schultertragegurte und Beckengurt</b></li> <li>• zusätzlicher, verstellbarer Brustgurt</li> <li>• Tragegestell und anpassbares Rückennetzteil für <b>optimal belüfteten Tragekomfort</b></li> <li>• <b>integrierter Regenüberzug</b></li> <li>• mit <b>Reflexaufdruck</b></li> <li>• <b>inkl. abnehmbarem Helmaufbewahrungsnetz</b></li> <li>• 1 Hauptfach und 4 kleinere Fächer mit Reißverschluss</li> <li>• integriertes, <b>isoliertes</b> Fach für <b>Trinkblase</b></li> <li>• zusätzlich 2 äußere Fächer und 1 großes Innenfach</li> <li>• mit Rücklichthalter</li> <li>• Volumen ca. 15 Liter</li> <li>• ca. 46 x 28 x 12 cm</li> </ul> <p><b>122634</b> schwarz / blau</p> <p><b>122635</b> neongelb, <b>besonders gute Sichtbarkeit durch leuchtende Farbe und Reflexaufdruck</b></p> <p>10</p>	<p><b>BIKER SPECIAL BACKPACK ›BP BACK‹</b></p> <ul style="list-style-type: none"> <li>• <b>padded, breathable shoulder straps and waist belt</b></li> <li>• additional, adjustable chest belt</li> <li>• carrying structure and adaptable back net for <b>optimally ventilated wearing comfort</b></li> <li>• <b>integrated rain cover</b></li> <li>• with <b>reflective print</b></li> <li>• <b>incl. detachable helmet storage net</b></li> <li>• 1 main compartment and 4 smaller pockets with zipper</li> <li>• integrated <b>insulated</b> compartment for <b>water bag</b></li> <li>• additionally 2 outer compartments and 1 big inner compartment</li> <li>• with rear light strap</li> <li>• volume approx. 15 litres</li> <li>• approx. 46 x 28 x 12 cm</li> </ul> <p>black / blue</p> <p>neon yellow, <b>very good visibility due to bright colour and reflective print</b></p> <p>UVP 45,90 €</p>	    	
<p><b>122536</b></p> <p>50</p>	<p><b>FALTRUCKSACK ›DELUXE‹</b></p> <ul style="list-style-type: none"> <li>• nur 287 g</li> <li>• zusammengefaltet nur 16 x 11 x 8 cm (L x B x H), aufgefaltet ca. 49 x 28 x 13 cm</li> <li>• Volumen ca. 20 Liter</li> <li>• <b>3 Fächer</b> mit Reißverschluss: Haupt-, Front- und Innenfach (das gleichzeitig als Tasche für den gefalteten Rucksack dient)</li> <li>• <b>Helmfach</b> mit drei justierbaren Klippverschluss-Gurten</li> <li>• 2 <b>elastische Außennetztaschen</b> (für Trinkflaschen, ...)</li> <li>• leicht gepolstertes Rückenteil</li> <li>• justierbare, leicht gepolsterte Schultergurte mit 2 x 3 Organizer-Laschen</li> <li>• zusätzlicher <b>Brustgurt</b> für perfekten Sitz</li> <li>• mit Befestigungsclips für Rahmen, Sattelgestell, ...</li> </ul>	<p><b>FOLDABLE BACKPACK ›DELUXE‹</b></p> <ul style="list-style-type: none"> <li>• only 287 g</li> <li>• folded size only 16 x 11 x 8 cm (L x W x H), unfolded approx. 49 x 28 x 13 cm</li> <li>• volume approx. 20 litres</li> <li>• <b>3 compartments</b> with zipper: main, front and inner compartment (which is also the storage bag for the folded backpack)</li> <li>• <b>helmet case</b> with 3 adjustable clip belts</li> <li>• 2 <b>elastic outer net pockets</b> (for bottles, ...)</li> <li>• slightly padded back part</li> <li>• adjustable, slightly padded shoulder straps with 2 x 3 organizer clips</li> <li>• additional <b>chest belt</b> for perfect fit</li> <li>• with fixing clips for frames, saddle rails, ...</li> </ul> <p>UVP 23,90 €</p>	  <p><b>FOLDED</b></p> 

ART.-NR. 	BESCHREIBUNG	DESCRIPTION	
<b>122352</b> 100	<b>TASCHEN + KORBÜBERZUG ›MAASTRICHT PROTECT‹</b> <ul style="list-style-type: none"> <li>• <b>universeller</b> Regenschutz für <b>Rucksäcke</b> bis ca. 25 Liter, <b>Körbe</b>, Vorderradtaschen, Gepäcktaschen, ...</li> <li>• mit <b>2 Haltegurten</b> auf der Rückseite</li> <li>• neongelb</li> <li>• <b>3M Scotchlite® Reflexstreifen</b> auf drei Seiten</li> <li>• mit aufgesetzter Netztasche</li> <li>• auf M-Wave Eurolochkarte</li> </ul>	<b>BAG + BASKET COVER ›MAASTRICHT PROTECT‹</b> <ul style="list-style-type: none"> <li>• <b>universal</b> rain protection for <b>backbags</b> up to approx. 25 litres, <b>baskets</b>, front bags, rear bags, ...</li> <li>• with <b>2 fixation straps</b> on back</li> <li>• neon yellow</li> <li>• <b>3M Scotchlite® reflective stripes</b> on three sides</li> <li>• with fitted net pocket</li> <li>• on M-Wave eurohole card</li> </ul> <p style="text-align: right;">UVP 10,90 €</p>	
<b>122500</b> 20  <b>122503</b> 50	<b>TRINKRUCKSACK ›MAASTRICHT H2O‹</b> <ul style="list-style-type: none"> <li>• <b>2-Liter-Wasserblase</b> von <b>SOURCE</b> mit <b>antibakterieller Innenbeschichtung</b> (Art. 122515)</li> <li>• <b>große Reinigungsöffnung</b></li> <li>• Trinkschlauch mit <b>auswechselbarem, drehbarem Clip-on-Mundstück</b> (Art. 122516)</li> <li>• <b>isoliertes</b> Fach</li> <li>• mit Reflexstreifen</li> <li>• mit <b>2 Zusatztaschen</b></li> <li>• Volumen: ca. 6 Liter</li> </ul> <p><b>122503</b> Rucksack ohne Wasserblase und Trinkschlauch</p>	<b>WATER BACKPACK ›MAASTRICHT H2O‹</b> <ul style="list-style-type: none"> <li>• <b>2-litres-water bag</b> from <b>SOURCE</b> with <b>antimicrobial protection inside</b> (art. 122515)</li> <li>• <b>big opening for cleaning</b></li> <li>• drinking tube with <b>exchangeable, turnable clip-on</b> bite valve (Art. 122516)</li> <li>• <b>insulated</b> compartment</li> <li>• with reflective stripes</li> <li>• with <b>2 additional pockets</b></li> <li>• volume: approx. 6 litres</li> </ul> <p>UVP 36,90 €</p> <p>backpack without water bag and drinking tube</p> <p style="text-align: right;">UVP 17,90 €</p>	
<b>122515</b> 110	<b>WASSERBLASE ›SOURCE‹</b> <ul style="list-style-type: none"> <li>• 2-Liter-Wasserblase mit <b>antibakterieller Innenbeschichtung</b></li> <li>• 2.000 % <b>glattere Oberfläche</b> als herkömmliche TPU-Folien beugt Schimmelbildung vor</li> <li>• <b>große Öffnung</b> für schnelles und leichtes Befüllen und Reinigen</li> <li>• <b>geschmacksneutral</b> und <b>frei von BPA und Phthalaten</b></li> <li>• Trinkschlauch mit <b>antibakterieller Innenbeschichtung</b> und <b>auswechselbarem Silikon-Mundstück</b> (Art. 122516)</li> <li>• passend für Trinkrucksäcke, z. B. Art. 122503, 122634</li> </ul>	<b>WATER BAG ›SOURCE‹</b> <ul style="list-style-type: none"> <li>• 2-litres-water bag with <b>antimicrobial protection inside</b></li> <li>• 2,000 % <b>smoother surface</b> than conventional TPU foils prevents mould formation</li> <li>• <b>big opening</b> for fast and easy filling and cleaning</li> <li>• <b>tasteless</b> and <b>free from BPA and phthalates</b></li> <li>• drinking tube with <b>antimicrobial protection inside</b> and <b>exchangeable silicone bite valve</b> (art. 122516)</li> <li>• suitable for water backpacks, e. g. art. 122503, 122634</li> </ul> <p style="text-align: right;">UVP 22,90 €</p>	
<b>122381</b> 150	<b>OBERARMTASCHE ›MAASTRICHT ARM‹</b> <ul style="list-style-type: none"> <li>• <b>universell passend</b> für viele <b>Smartphones</b> (170 x 120 mm)</li> <li>• drei <b>Kopfhörerausgänge</b></li> <li>• mit elastischem Klettverschluss</li> <li>• transparentes Sichtfenster</li> <li>• auf M-Wave Eurolochkarte</li> </ul>	<b>UPPER ARM BAG ›MAASTRICHT ARM‹</b> <ul style="list-style-type: none"> <li>• <b>universally suitable</b> for many <b>smartphones</b> (170 x 120 mm)</li> <li>• <b>3 exits for ear-phones</b></li> <li>• with elastic hook and loop fastener</li> <li>• transparent window</li> <li>• on M-Wave eurohole card</li> </ul> <p style="text-align: right;">UVP 7,90 €</p>	
<b>INFO</b>	Auf Wunsch verpacken wir jede Tasche auf einer <b>M-Wave Eurolochkarte</b> (Art. 083115).	On request, we'll attach any bag to a <b>M-Wave eurohole card</b> (art. 083115).	



ART.-NR. 	BESCHREIBUNG	DESCRIPTION	
<b>122353</b> 200	<b>SATTEL-/SCHLAUCHTASCHE</b> <ul style="list-style-type: none"> <li>• Befestigung mit Klettverschluss an Sattel, Rahmenrohr, ...</li> <li>• zur Aufbewahrung eines Ersatzschlauchs, Reifenhebers und Miniwerkzeug</li> <li>• ca. 140 x 85 x 50 mm</li> <li>• mit <b>Reflex</b>label</li> <li>• mit Ventura Karte</li> </ul>	<b>SADDLE/TUBE BAG</b> <ul style="list-style-type: none"> <li>• fixing with hook and loop fastener at saddle, frame tubes, ...</li> <li>• for keeping a replacement tube, tire lever and mini tool</li> <li>• approx. 140 x 85 x 50 mm</li> <li>• with <b>reflective</b> label</li> <li>• with Ventura tag</li> </ul>	 <p>UVP 3,90 €</p>
<b>122290</b> 50 Set	<b>REPARATUR-SET</b> bestehend aus:  <b>Satteltasche</b> (Art. 122353)  <b>Mini-Faltwerkzeug</b> (Art. 880940) 11 Funktionen <ul style="list-style-type: none"> <li>• 2/2,5/3/4/5/6/8 mm Stahl-Innensechskant</li> <li>• 1 Schlitzschraubendreher</li> <li>• 1 Kreuzschraubendreher</li> <li>• 1 Kettennietdrücker</li> <li>• T 25 Vielzahnschlüssel</li> <li>• mit Nylontasche</li> </ul> <b>Flickzeugset</b> (Art. 880162) <ul style="list-style-type: none"> <li>• 1 Tube Vulkanisierlösung (10 ml / 6,5 g)</li> <li>• 2 Flicker Ø 26 mm</li> <li>• 4 Flicker 25 x 34 mm</li> <li>• 1 Flicker 34 x 51 mm</li> <li>• 1 Sandpapier</li> <li>• 1 Ventilschlauch</li> <li>• Arbeitsanleitung</li> <li>• in Kunststoffbox</li> </ul> <b>Reifenheber</b> (Art. 880018) <ul style="list-style-type: none"> <li>• Kunststoff</li> <li>• 3 Stück im Set</li> </ul> auf Ventura Eurolochkarte	<b>REPAIR KIT</b> consisting of:  <b>saddle bag</b> (art. 122353)  <b>Mini Folding Tool</b> (art. 880940) 11 functions <ul style="list-style-type: none"> <li>• 2/2.5/3/4/5/6/8 mm steel allen key</li> <li>• 1 flat screwdriver</li> <li>• 1 Phillips screwdriver</li> <li>• 1 chain riveting tool</li> <li>• T 25 star screwdriver</li> <li>• with nylon bag</li> </ul> <b>Repair Kit</b> (art. 880162) <ul style="list-style-type: none"> <li>• 1 tube solution (10 ml / 6.5 g)</li> <li>• 2 patches Ø 26 mm</li> <li>• 4 patches 25 x 34 mm</li> <li>• 1 patch 34 x 51 mm</li> <li>• 1 sand paper</li> <li>• 1 valve tube</li> <li>• instruction</li> <li>• in box</li> </ul> <b>Tire Levers</b> (art. 880018) <ul style="list-style-type: none"> <li>• plastic</li> <li>• 3 pieces in a set</li> </ul> on Ventura eurohole card	 <p>UVP 17,90 €</p>



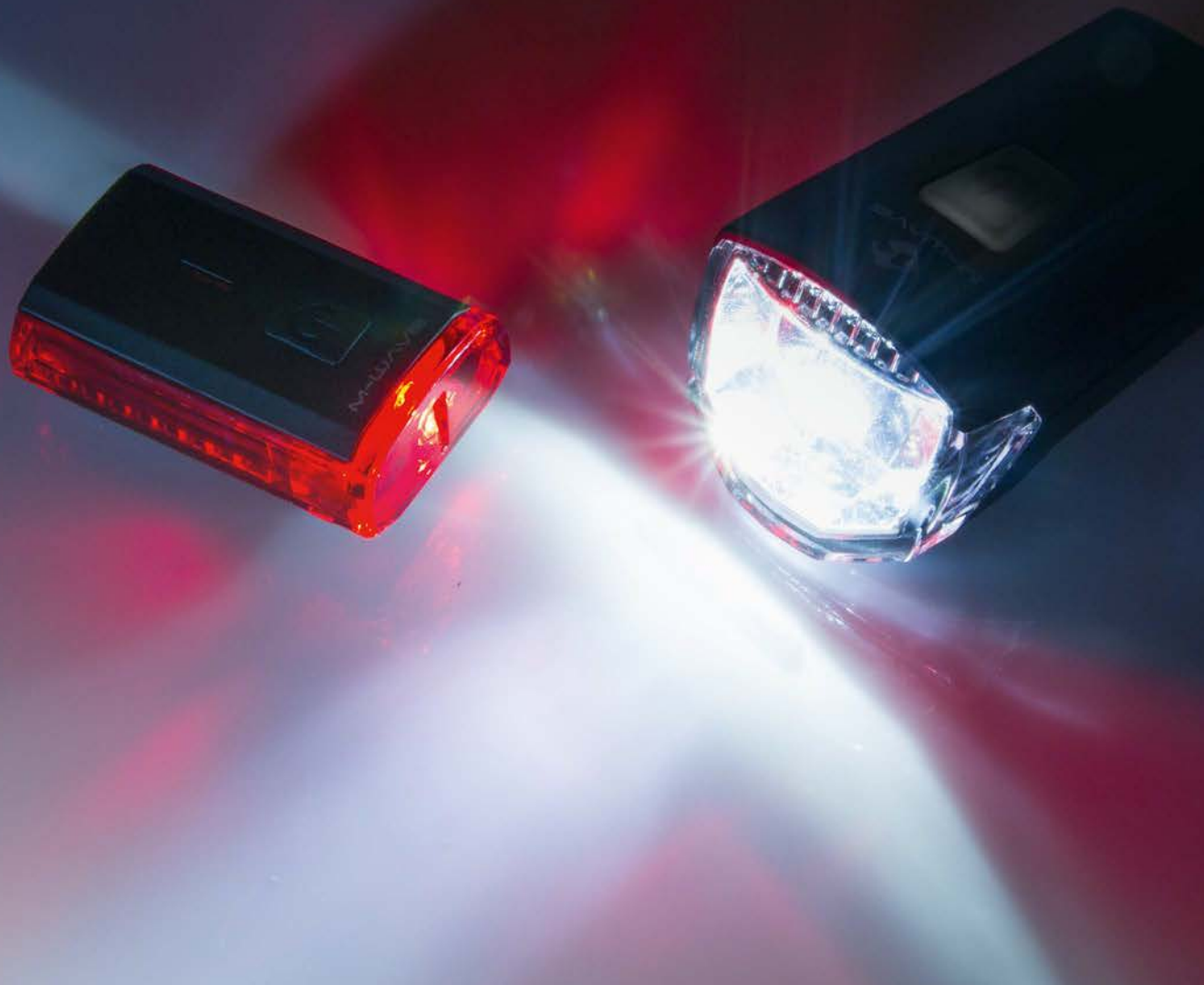

# LAMPS

ART.-NR. 	BESCHREIBUNG	DESCRIPTION	
<b>220732</b> 20/5	<b>AKKULAMPE ›ADJ-1300‹</b> <ul style="list-style-type: none"> <li>hochwertiges, wasserfestes <b>Aluminium-Gehäuse, CNC-gefräst</b></li> <li>2 weiße  <b>XM-L LEDs</b></li> <li>max. Lichtleistung: <b>1.300 Lumen</b></li> <li><b>85 Lux</b> in 10 m Entfernung</li> <li>LEDs einzeln von <b>-19° bis +12° verstellbar</b></li> <li><b>7 Funktionen</b> (4x Dauer- und 3x Blinklicht) inkl. SOS-Modus</li> <li>nur <b>99 g</b></li> <li>externer Lithium Ionen-Akku (3,7 V - 6.400 mAh, 195 g)</li> <li>Batteriezustandsanzeige mit <b>5 LEDs</b>, als <b>Rücklicht</b> verwendbar</li> <li>ca. 2 - 10 Stunden Laufzeit</li> <li>inkl. 220 V Ladegerät</li> <li><b>Auflademöglichkeit für andere USB-Geräte</b></li> <li>mit <b>360° Dreh-Clip-on-Halter</b>, Ø 22,0 - 31,8 mm, werkzeuglose Montage</li> <li>Lenker- und Helmhalter</li> <li>mit <b>Fernbedienung</b> und <b>Verlängerungskabel</b></li> <li>in Moon Softcase</li> </ul>	<b>RECHARGEABLE LAMP ›ADJ-1300‹</b> <ul style="list-style-type: none"> <li>high quality, water resistant <b>aluminium housing, CNC machined</b></li> <li>2 white  <b>XM-L LEDs</b></li> <li>max. light output: <b>1,300 lumen</b></li> <li><b>85 Lux</b> in 10 m distance</li> <li>LEDs separately <b>adjustable</b> from <b>-19° to +12°</b></li> <li><b>7 functions</b> (4x steady and 3x flashing light) incl. SOS mode</li> <li>only <b>99 g</b></li> <li>external rechargeable Lithium Ion battery (3.7 V - 6,400 mAh, 195 g)</li> <li>battery level indicator with <b>5 LEDs</b>, usable as <b>rear light</b></li> <li>approx. 2 - 10 hours run time</li> <li>with 220 V charger</li> <li><b>charging of other USB devices possible</b></li> <li>with <b>360° twist-clip-on bracket</b>, Ø 22.0 - 31.8 mm, toolless mounting</li> <li>handlebar and helmet bracket</li> <li>with <b>remote control</b> and <b>extension cable</b></li> <li>in Moon soft case</li> </ul>	 <p><b>1.300 LUMEN</b></p>  <p><b>LED REAR LIGHT</b></p> 
	<b>AKKULAMPE ›RIGEL‹</b> <ul style="list-style-type: none"> <li>hochwertiges <b>CNC-gefrästes Aluminium-Kunststoff-Gehäuse</b></li> <li>2 LEDs</li> <li><b>180° drehbare Linse</b> für Montage von unten</li> <li><b>Variable Lumen System VLS</b> - Dimmfunktion für <b>längere Akkulaufzeit</b></li> <li>Batterie- und Ladezustandsanzeige</li> <li><b>Modusanzeige mit Memoryfunktion</b></li> <li><b>6 Funktionen</b> (2x Dauer- und 4x Blinklicht) inkl. SOS-Modus</li> <li>mit Gummiband-Universalhalter (Art. 223568) für <b>Ø 22 - 35 mm</b>, passend für <b>Garmin</b> (kein original Garmin Ersatzteil)</li> <li>werkzeuglose Montage</li> <li>inkl. USB-C Ladekabel</li> <li>in Moon Eurolochbox</li> </ul>	<b>RECHARGEABLE LAMP ›RIGEL‹</b> <ul style="list-style-type: none"> <li>high quality <b>CNC machined aluminium plastic housing</b></li> <li>2 LEDs</li> <li><b>180° turnable lens</b> for mounting from below</li> <li><b>variable lumen system VLS</b> - dimming function for <b>longer battery life</b></li> <li>battery level and charge control indicator</li> <li><b>mode display with memory function</b></li> <li><b>6 functions</b> (2x steady and 4x flashing light) incl. SOS mode</li> <li>with rubber strap universal bracket (Art. 223568) for <b>Ø 22 - 35 mm</b>, suitable for <b>Garmin</b> (no original Garmin spare part)</li> <li>toolless mounting</li> <li>incl. USB-C charging cable</li> <li>in Moon eurohole box</li> </ul>	<p><b>1.000 LUMEN</b></p>  <p><b>GARMIN COMPATIBLE</b></p> 
	<b>220746 ›RIGEL PRO‹</b> <ul style="list-style-type: none"> <li>max. Lichtleistung: <b>1.000 Lumen</b></li> <li><b>intelligenter Tag-/Nacht-Modus</b> mit Modus-Anzeige und bis zu <b>450 Stunden Standby</b></li> <li>inkl. Lithium Ionen-Akku (3,7 V - 2.200 mAh)</li> <li>bis zu <b>336 Stunden Laufzeit</b></li> <li>nur <b>103 g</b></li> </ul>	<b>›RIGEL PRO‹</b> <ul style="list-style-type: none"> <li>max. light output: <b>1,000 Lumen</b></li> <li><b>intelligent day/night time mode</b> with mode display and up to <b>450 hours standby</b></li> <li>incl. rechargeable Lithium Ion battery (3.7 V - 2,200 mAh)</li> <li>up to <b>336 hours run time</b></li> <li>only <b>103 g</b></li> </ul>	
	<b>220747 ›RIGEL LITE‹</b> <ul style="list-style-type: none"> <li>max. Lichtleistung: <b>500 Lumen</b></li> <li>inkl. Lithium Ionen-Akku (3,7 V - 1.200 mAh)</li> <li>bis zu <b>160 Stunden Laufzeit</b></li> <li>nur <b>80 g</b></li> </ul>	<b>›RIGEL LITE‹</b> <ul style="list-style-type: none"> <li>max. light output: <b>500 Lumen</b></li> <li>incl. rechargeable Lithium Ion battery (3.7 V - 1,200 mAh)</li> <li>up to <b>160 hours run time</b></li> <li>only <b>80 g</b></li> </ul>	

Ohne deutsches Prüfzeichen - Verkauf und Nutzung im Geltungsbereich der StVZO (Deutschland) unzulässig (Abgabe nur an außerdeutsche Kunden).

UVP 244,00 €

Ohne deutsches Prüfzeichen - Verkauf und Nutzung im Geltungsbereich der StVZO (Deutschland) unzulässig (Abgabe nur an außerdeutsche Kunden).

UVP 48,90 €





ART.-NR.	BESCHREIBUNG	DESCRIPTION	
<b>220743</b> 50	<b>AKKULAMPE ›METEOR‹</b> <ul style="list-style-type: none"> <li>• weiße <b>CREE</b> XP-G Hochleistungs-LED</li> <li>• spritzwassergeschütztes Gehäuse</li> <li>• maximale Lichtleistung: <b>400 Lumen</b></li> <li>• 36 Lux in 10 m Entfernung</li> <li>• nur <b>66 g</b></li> <li>• 8 Funktionen (4x Dauer- und 4x Blinklicht)</li> <li>• mit <b>Memoryfunktion</b></li> <li>• <b>Präzisionslinse</b> für volle Ausleuchtung</li> <li>• inkl. Lithium Polymer-Akku (1.050 mAh)</li> <li>• bis zu <b>80 Stunden Laufzeit</b></li> <li>• aufladbar über <b>USB-Kabel</b> (inklusive)</li> <li>• Batterie- und Ladezustandsanzeige</li> <li>• mit schwenkbarer Gummihalfterung für Lenker (Art. 223550)</li> <li>• werkzeuglose Montage</li> <li>• in Moon Eurolochbox</li> </ul> <p>Ohne deutsches Prüfzeichen - Verkauf und Nutzung im Geltungsbereich der StVZO (Deutschland) unzulässig (Abgabe nur an außerdeutsche Kunden).</p>	<b>RECHARGEABLE LAMP ›METEOR‹</b> <ul style="list-style-type: none"> <li>• white <b>CREE</b> XP-G high power LED</li> <li>• water resistant housing</li> <li>• max. light output: <b>400 lumen</b></li> <li>• 36 Lux in 10 m distance</li> <li>• only <b>66 g</b></li> <li>• 8 functions (4x steady and 4x flashing light)</li> <li>• with <b>memory</b> function</li> <li>• <b>precision lens</b> for full illumination</li> <li>• incl. rechargeable Lithium Polymer battery (1,050 mAh)</li> <li>• up to <b>80 hours run time</b></li> <li>• rechargeable by <b>USB cable</b> (included)</li> <li>• battery level and charge control indicator</li> <li>• with adjustable rubber bracket for handlebars (art. 223550)</li> <li>• toolless mounting</li> <li>• in Moon eurohole box</li> </ul> <p>UVP 44,90 €</p>	
<b>220736</b> 50/20	<b>BATTERIELAMPE ›NOVA 100‹</b> <ul style="list-style-type: none"> <li>• 1 weiße <b>CREE</b> XH-G LED mit <b>100 Lumen</b></li> <li>• <b>klein aber hell</b></li> <li>• 5 Funktionen (3x Dauer- und 2x Blinklicht)</li> <li>• nur <b>54 g</b></li> <li>• bis zu 13 Stunden Laufzeit</li> <li>• Universalhalter passend für Ø 22 - 31,8 mm (Art. 223544)</li> <li>• inkl. <b>Batterie</b> (1x AA)</li> <li>• werkzeuglose Montage</li> <li>• in Moon Eurolochbox</li> </ul> <p>Ohne deutsches Prüfzeichen - Verkauf und Nutzung im Geltungsbereich der StVZO (Deutschland) unzulässig (Abgabe nur an außerdeutsche Kunden).</p>	<b>BATTERY LAMP ›NOVA 100‹</b> <ul style="list-style-type: none"> <li>• 1 white <b>CREE</b> XH-G LED with <b>100 lumen</b></li> <li>• <b>small but bright</b></li> <li>• 5 functions (3x steady and 2x flashing light)</li> <li>• only <b>54 g</b></li> <li>• up to 13 hours run time</li> <li>• universal bracket for Ø 22 - 31.8 mm (art. 223544)</li> <li>• incl. <b>battery</b> (1x AA)</li> <li>• toolless mounting</li> <li>• in Moon eurohole box</li> </ul> <p>UVP 16,90 €</p>	
<b>220748</b> 50	<b>AKKUBLINKLICHT ›HELIX LITE‹</b> <ul style="list-style-type: none"> <li>• hochwertiges <b>CNC-gefrästes Aluminium-Kunststoffgehäuse</b></li> <li>• <b>COB Hochleistungsleuchtband</b> mit <b>27 LED-Chips</b></li> <li>• max. Lichtleistung: <b>100 Lumen</b></li> <li>• <b>5 Funktionen</b> (2x Dauer- und 3x Blinklicht)</li> <li>• <b>Variable Lumen System VLS</b> - Dimmfunktion für <b>längere Akkulaufzeit</b></li> <li>• mit <b>Memoryfunktion</b></li> <li>• inkl. <b>Lithium-Polymer Akku</b> (3,7 V / 500 mAh)</li> <li>• bis zu <b>54 Stunden Laufzeit</b></li> <li>• Batterie- und Ladezustandsanzeige</li> <li>• aufladbar über <b>USB-Kabel</b> (inklusive)</li> <li>• mit Gummiband-Universalhalter (Art. 223569) für Ø 20 - 52 mm und Halter für Sattelgestell</li> <li>• werkzeuglose Montage</li> <li>• nur <b>28g</b></li> <li>• in Moon Eurolochbox</li> </ul> <p>Ohne deutsches Prüfzeichen - Verkauf und Nutzung im Geltungsbereich der StVZO (Deutschland) unzulässig (Abgabe nur an außerdeutsche Kunden).</p>	<b>RECHARGEABLE FLASHING LIGHT ›HELIX LITE‹</b> <ul style="list-style-type: none"> <li>• high quality <b>CNC machined aluminium</b> plastic housing</li> <li>• <b>COB high performance light band</b> with <b>27 LED chips</b></li> <li>• max. light output: <b>100 lumen</b></li> <li>• <b>5 functions</b> (2x steady and 3x flashing light)</li> <li>• <b>variable lumen system VLS</b> - dimming function for <b>longer battery life</b></li> <li>• with <b>memory</b> function</li> <li>• incl. <b>rechargeable Lithium Polymer battery</b> (3.7 V / 500 mAh)</li> <li>• up to <b>54 hours run time</b></li> <li>• battery level and charge control indicator</li> <li>• rechargeable by <b>USB cable</b> (included)</li> <li>• with rubber strap universal bracket (Art. 223569) for Ø 20 - 52 mm and saddle rail bracket</li> <li>• toolless mounting</li> <li>• only <b>28g</b></li> <li>• in Moon eurohole box</li> </ul> <p>UVP 33,90 €</p>	

ART.-NR.	BESCHREIBUNG	DESCRIPTION	
<p><b>220456</b></p> <p>50/10</p>	<p><b>AKKUBLINKLICHT</b></p> <ul style="list-style-type: none"> <li>• zusätzliche seitliche Leuchtwirkung</li> <li>• <b>CNC-gefrästes Aluminiumgehäuse</b></li> <li>• <b>superleicht: nur 24 g!</b></li> <li>• <b>COB Hochleistungsleuchtband mit 30 LED-Chips</b></li> <li>• 7 Funktionen (3x Dauer- und 4x Blinklicht) inkl. Tageslichtblinkfunktion</li> <li>• bis zu <b>20 Stunden</b> Laufzeit</li> <li>• <b>Auto-Save-Funktion:</b> mindestens 1 h verlängerte Leuchtdauer durch automatisches Umschalten in Energiespar-Modus</li> <li>• mit <b>Memoryfunktion</b></li> <li>• inkl. <b>Lithium-Polymer-Akku</b> (300 mAh)</li> <li>• Ladezeit ca. 2 Stunden</li> <li>• aufladbar über <b>USB-Kabel</b> (inkl.)</li> <li>• Batterie- und <b>Ladezustandsanzeige</b></li> <li>• mit Gummiband-Universalhalter für Ø 20 - 52 mm (Art. 223556) und Clip-on-Halter für Trikottasche, Gürtel, ... (Art. 223548), werkzeuglose Montage</li> <li>• 90° drehbar</li> <li>• in Moon Eurolochbox</li> </ul> <p>›COMET-X‹</p> <p>maximale Lichtleistung: <b>50 Lumen</b></p>	<p><b>RECHARGEABLE FLASHING LIGHT</b></p> <ul style="list-style-type: none"> <li>• additional lighting on each side</li> <li>• <b>CNC machined aluminium</b> housing</li> <li>• <b>superlight: only 24 g!</b></li> <li>• <b>COB high performance light band with 30 LED chips</b></li> <li>• 7 functions (3x steady and 4x flashing light) incl. daylight flashing function</li> <li>• up to <b>20 hours</b> run time</li> <li>• <b>auto-save function:</b> at least 1h extended bright life by switching automatically into power safe mode</li> <li>• with <b>memory function</b></li> <li>• incl. <b>rechargeable Lithium Polymer battery</b> (300 mAh)</li> <li>• charging time approx. 2 hours</li> <li>• rechargeable by <b>USB cable</b> (incl.)</li> <li>• battery level and <b>charge control indicator</b></li> <li>• with rubber strap universal bracket for Ø 20 - 52 mm (art. 223556) and clip-on bracket for jersey pocket, belt, ... (art. 223548), toolless mounting</li> <li>• 90° turnable</li> <li>• in Moon eurohole box</li> </ul> <p>›COMET-X‹</p> <p>max. light output: <b>50 lumen</b></p> <p>UVP 33,90 €</p>	<p><b>50 LUMEN</b></p>
<p><b>220727</b></p> <p>100/20</p>	<p>›COMET-X FRONT‹</p> <p>maximale Lichtleistung: <b>120 Lumen</b></p> <p>Ohne deutsches Prüfzeichen - Verkauf und Nutzung im Geltungsbereich der StVZO (Deutschland) unzulässig (Abgabe nur an außerdeutsche Kunden).</p>	<p>›COMET-X FRONT‹</p> <p>max. light output: <b>120 lumen</b></p> <p>UVP 31,90 €</p>	<p><b>120 LUMEN</b></p>
<p><b>220454</b></p> <p>100/20</p>	<p><b>AKKUBLINKLICHT</b></p> <p>›RING‹</p> <ul style="list-style-type: none"> <li>• Ring aus einem <b>COB Hochleistungsleuchtband mit 15 LED-Chips</b></li> <li>• maximale Lichtleistung: 50 Lumen</li> <li>• 7 Funktionen (3x Dauer- und 4x Blinklicht) inkl. Tagesblinklichtfunktion</li> <li>• mit <b>Memoryfunktion</b></li> <li>• <b>Auto-Save-Funktion:</b> mindestens 1 h verlängerte Leuchtdauer durch automatisches Umschalten in Energiespar-Modus</li> <li>• inkl. Lithium-Polymer-Akku (3,7 V - 280 mAh)</li> <li>• bis zu 19,5 Stunden Laufzeit</li> <li>• aufladbar über <b>USB-Kabel</b> (inkl.)</li> <li>• Ladezeit ca. 2 Stunden</li> <li>• mit <b>Gummiband-Universalhalter</b> für Ø 20 - 52 mm (Art. 223556) und Clip-on-Halter für Trikottasche, Gürtel, ... (Art. 223548)</li> <li>• werkzeuglose Montage</li> <li>• nur <b>21 g</b></li> <li>• 90° drehbar</li> <li>• in Moon Eurolochbox</li> </ul> <p>Ohne deutsches Prüfzeichen - Verkauf und Nutzung im Geltungsbereich der StVZO (Deutschland) unzulässig (Abgabe nur an außerdeutsche Kunden).</p>	<p><b>RECHARGEABLE FLASHING LIGHT</b></p> <p>›RING‹</p> <ul style="list-style-type: none"> <li>• ring of one <b>COB high performance light band with 15 LED chips</b></li> <li>• max. light output: 50 lumen</li> <li>• 7 functions (3x steady and 4x flashing light) incl. day flashing function</li> <li>• with <b>memory function</b></li> <li>• <b>auto-save function:</b> at least 1h extended bright life through switching automatically into power safe mode</li> <li>• incl. rechargeable Lithium Polymer battery (3.7 V - 280 mAh)</li> <li>• up to 19.5 hours run time</li> <li>• rechargeable by <b>USB cable</b> (incl.)</li> <li>• charging time approx. 2 hours</li> <li>• with <b>rubber strap universal bracket</b> for Ø 20 - 52 mm (art. 223556) and clip-on bracket for jersey pocket, belt, ... (art. 223548)</li> <li>• toolless mounting</li> <li>• only <b>21 g</b></li> <li>• 90° turnable</li> <li>• in Moon eurohole box</li> </ul> <p>UVP 24,90 €</p>	

ART.-NR. 	BESCHREIBUNG	DESCRIPTION	
<b>220462</b> 100/20	<b>AKKUBLINKLICHT ›ORION‹</b> <ul style="list-style-type: none"> <li>• Ring aus einem <b>COB Hochleistungs-leuchtband</b> mit <b>16 LED-Chips</b></li> <li>• max. Lichtleistung: <b>50 Lumen</b></li> <li>• 5 Funktionen (2x Dauer- und 3x Blinklicht) inkl. Tagesblinklichtfunktion</li> <li>• <b>integrierter Reflektor</b></li> <li>• <b>Auto-Safe-Mode</b></li> <li>• inkl. Lithium-Polymer-Akku (3,7 V - 300 mAh)</li> <li>• bis zu 53 Stunden Laufzeit</li> <li>• mit <b>Memoryfunktion</b></li> <li>• <b>magnetische Halterung</b> (zum einfachen und schnellen Abnehmen) mit Gummiband-Universalhalter für Ø 20-52 mm (Art. 223557), werkzeuglose Montage</li> <li>• Batterie- und Ladezustandsanzeige</li> <li>• aufladbar über <b>Micro-USB Kabel</b> (inkl.)</li> <li>• nur <b>22 g</b></li> <li>• 90° drehbar</li> <li>• in Moon Eurolochbox</li> </ul> <p><small>Ohne deutsches Prüfzeichen - Verkauf und Nutzung im Geltungsbereich der StVZO (Deutschland) unzulässig (Abgabe nur an außerdeutsche Kunden).</small></p>	<b>RECHARGEABLE FLASHING LIGHT ›ORION‹</b> <ul style="list-style-type: none"> <li>• ring of one <b>COB high performance light band</b> with <b>16 LED chips</b></li> <li>• max. light output: <b>50 lumen</b></li> <li>• 5 functions (2x steady and 3x flashing light) incl. day flashing function</li> <li>• <b>integrated reflector</b></li> <li>• <b>auto-safe-mode</b></li> <li>• incl. rechargeable Lithium Polymer battery (3.7 V - 300 mAh)</li> <li>• up to 53 hours run time</li> <li>• with <b>memory function</b></li> <li>• <b>magnetic bracket</b> (for easy and fast dismount) with rubber strap universal bracket for Ø 20-52 mm (art. 223557), toolless mounting</li> <li>• battery level and charge control indicator</li> <li>• rechargeable by <b>micro USB cable</b> (incl.)</li> <li>• only <b>22 g</b></li> <li>• 90° turnable</li> <li>• in Moon eurohole box</li> </ul> <p><small>UVP 24,90 €</small></p>	 <div style="border: 1px solid black; padding: 2px; display: inline-block;">MAGNETIC FIX</div>   
<b>220460</b> 200/40	<b>AKKUBLINKLICHT ›ALCOR‹</b> <ul style="list-style-type: none"> <li>• <b>1 superhelle rote SMD-LED</b></li> <li>• 5 Funktionen (2x Dauer- und 3x Blinklicht) inkl. Tagesblinklichtfunktion</li> <li>• mit <b>Memoryfunktion</b></li> <li>• inkl. <b>Lithium Polymer-Akku</b> (250 mAh)</li> <li>• bis zu <b>70 Stunden</b> Laufzeit</li> <li>• <b>magnetische Halterung</b> (zum einfachen und schnellen Abnehmen) mit Gummiband-Universalhalter für Ø 20-52 mm (Art. 223557), werkzeuglose Montage</li> <li>• aufladbar über <b>USB-Anschluss</b></li> <li>• Batterie- und Ladezustandsanzeige</li> <li>• nur <b>17 g</b></li> <li>• 90° drehbar</li> <li>• in Moon Eurolochbox</li> </ul> <p><small>Ohne deutsches Prüfzeichen - Verkauf und Nutzung im Geltungsbereich der StVZO (Deutschland) unzulässig (Abgabe nur an außerdeutsche Kunden).</small></p>	<b>RECHARGEABLE FLASHING LIGHT ›ALCOR‹</b> <ul style="list-style-type: none"> <li>• <b>1 super bright red SMD-LED</b></li> <li>• 5 functions (2x steady and 3x flashing light) incl. day flashing light</li> <li>• with <b>memory function</b></li> <li>• incl. <b>rechargeable Lithium Polymer battery</b> (250 mAh)</li> <li>• up to <b>70 hours</b> run time</li> <li>• <b>magnetic bracket</b> (for easy and fast dismount) with rubber strap universal bracket for Ø 20-52 mm (art. 223557), toolless mounting</li> <li>• rechargeable by <b>USB plug</b></li> <li>• battery level and charge control indicator</li> <li>• only <b>17 g</b></li> <li>• 90° turnable</li> <li>• in Moon eurohole box</li> </ul> <p><small>UVP 19,90 €</small></p>	 <div style="border: 1px solid black; padding: 2px; display: inline-block;">MAGNETIC FIX</div>   











ART.-NR. 	BESCHREIBUNG	DESCRIPTION		
	<p><b>ERSATZ- ODER ZWEITHALTER</b></p> <ul style="list-style-type: none"> <li>• <b>Gummiband-Universalhalter</b></li> <li>• schnelle, <b>werkzeuglose Montage</b></li> <li>• im Polybeutel mit Moon Eurolochheader</li> </ul>	<p><b>SPARE OR SECOND BRACKET</b></p> <ul style="list-style-type: none"> <li>• <b>rubber strap universal bracket</b></li> <li>• fast, <b>toolless mounting</b></li> <li>• in PE bag with Moon eurohole header</li> </ul>		
<p><b>223569</b> <b>NEW</b> 100</p>	<ul style="list-style-type: none"> <li>• auch geeignet für Art. 220748, ...</li> <li>• <b>Ø 20 - 52 mm</b></li> </ul>	<ul style="list-style-type: none"> <li>• also suitable for art. 220748, ...</li> <li>• <b>Ø 20 - 52 mm</b></li> </ul> <p>UVP 12,90 €</p>	 	
<p><b>223550</b> 100</p>	<ul style="list-style-type: none"> <li>• für Art. 220743, 220744, ...</li> <li>• Ø 19 - 35 mm</li> </ul>	<ul style="list-style-type: none"> <li>• for art. 220743, 220744, ...</li> <li>• Ø 19 - 35 mm</li> </ul> <p>UVP 6,90 €</p>	 	
<p><b>223568</b> <b>NEW</b> 100</p>	<ul style="list-style-type: none"> <li>• auch geeignet für Art. 220746/7, ...</li> <li>• <b>Ø 22 - 35 mm</b></li> <li>• passend für <b>Garmin</b> (kein original Garmin Ersatzteil)</li> </ul>	<ul style="list-style-type: none"> <li>• also suitable for art. 220746/7, ...</li> <li>• <b>Ø 22 - 35 mm</b></li> <li>• suitable for <b>Garmin</b> (no original Garmin spare part)</li> </ul> <p>UVP 6,90 €</p>	 	
<p><b>223546</b> 100</p>	<ul style="list-style-type: none"> <li>• für Art. 220454/6, 220461, 220727, ...</li> <li>• Ø 19 - 33 mm</li> </ul>	<ul style="list-style-type: none"> <li>• for art. 220454/6, 220461, 220727, ...</li> <li>• Ø 19 - 33 mm</li> </ul> <p>UVP 5,90 €</p>	 	
<p><b>223556</b> 100</p>	<ul style="list-style-type: none"> <li>• für Art. 220454/6, 220461, 220727, ...</li> <li>• Ø 19 - 40 mm</li> </ul>	<ul style="list-style-type: none"> <li>• for art. 220454/6, 220461, 220727, ...</li> <li>• Ø 19 - 40 mm</li> </ul> <p>UVP 5,90 €</p>	 	
<p><b>223544</b> 100</p>	<ul style="list-style-type: none"> <li>• für Art. 220736, ...</li> <li>• Ø 19 - 31,8 mm</li> </ul>	<ul style="list-style-type: none"> <li>• for art. 220736, ...</li> <li>• Ø 19 - 31.8 mm</li> </ul> <p>UVP 5,90 €</p>	 	
<p><b>223557</b> 100</p>	<ul style="list-style-type: none"> <li>• <b>magnetisch</b></li> <li>• für Art. 220462/0, ...</li> <li>• Ø 20 - 52 mm</li> </ul>	<ul style="list-style-type: none"> <li>• <b>magnetic</b></li> <li>• for art. 220462/0, ...</li> <li>• Ø 20 - 52 mm</li> </ul>	<p><b>MAGNETIC FIX</b></p>  	
<p><b>223547</b> 100</p>	<ul style="list-style-type: none"> <li>• Klemmhalter für das <b>Sattelgestell</b></li> <li>• für Art. 220454/6, 220461, ...</li> <li>• im Polybeutel mit Moon Eurolochheader</li> </ul>	<ul style="list-style-type: none"> <li>• bracket for <b>saddle rails</b></li> <li>• for art. 220454/6, 220461, ...</li> <li>• in PE bag with Moon eurohole header</li> </ul> <p>UVP 4,90 €</p>	 	
<p><b>223552</b> 100</p>	<ul style="list-style-type: none"> <li>• Adapter für <b>GoPro</b> und <b>QRIR</b> (Art. 390635 ff.) Montage</li> <li>• für Art. 220732, 220744, 220743, ...</li> <li>• im Polybeutel mit Moon Eurolochheader</li> </ul>	<ul style="list-style-type: none"> <li>• bracket for <b>GoPro</b> and <b>QRIR</b> (art. 390635 et seq.) mounting</li> <li>• for art. 220732, 220744, 220743, ...</li> <li>• in PE bag with Moon eurohole header</li> </ul> <p>UVP 3,90 €</p>	 	
<p><b>223567</b> 100/20 <b>NEW</b></p>	<ul style="list-style-type: none"> <li>• <b>Rucksack-/ Gürtel-/ Trikottaschen-Clip</b></li> <li>• für Art. 220748, ...</li> <li>• im Polybeutel mit Moon Eurolochheader</li> </ul>	<ul style="list-style-type: none"> <li>• <b>for backpack/ belt/ jersey pocket clip</b></li> <li>• for art. 220748, ...</li> <li>• in PE bag with Moon eurohole header</li> </ul> <p>UVP 5,90 €</p>	 	
<p><b>223548</b> 100/20</p>	<ul style="list-style-type: none"> <li>• <b>Rucksack-/ Gürtel-/ Trikottaschen-Clip</b></li> <li>• für Art. 220454/6, 220461, 220727, ...</li> <li>• im Polybeutel mit Moon Eurolochheader</li> </ul>	<ul style="list-style-type: none"> <li>• <b>for backpack/ belt/ jersey pocket clip</b></li> <li>• for art. 220454/6, 220461, 220727, ...</li> <li>• in PE bag with Moon eurohole header</li> </ul> <p>UVP 4,90 €</p>	 	

ART.-NR.	BESCHREIBUNG	DESCRIPTION	
<b>220840</b> 20/10	<b>AKKULAMPE</b> <b>›SUBURB 800‹</b> <ul style="list-style-type: none"> <li>• <b>1 Cree Hochleistungs-LED</b></li> <li>• <b>800 Lumen</b></li> <li>• 4 Funktionen (3x Dauer- und 1x Blinklicht)</li> <li>• seitlich abstrahlendes, oranges Sicherheitslicht</li> <li>• stabiler <b>Aluminiumkopf</b></li> <li>• <b>Panasonic</b> Lithium-Ionen-Akku mit 3.350 mAh</li> <li>• Leuchtdauer: 2 - 40 Stunden</li> <li>• <b>wasserdicht</b> gemäß IP66</li> <li>• aufladbar über <b>USB-Kabel</b> (inkl.)</li> <li>• mit Batteriezustandsanzeige</li> <li>• mit universellem Halter bis Ø 31,8 mm</li> <li>• auf Smart Eurolochkarte</li> </ul>	<b>RECHARGEABLE LAMP</b> <b>›SUBURB 800‹</b> <ul style="list-style-type: none"> <li>• <b>1 Cree high power LED</b></li> <li>• <b>800 lumen</b></li> <li>• 4 functions (3x steady and 1x flashing light)</li> <li>• laterally radiating, orange safety light</li> <li>• stable <b>aluminium</b> head</li> <li>• rechargeable <b>Panasonic</b> Lithium Ion battery with 3,350 mAh</li> <li>• run time: 2 - 40 hours</li> <li>• <b>waterproof</b> according to IP66</li> <li>• rechargeable by <b>USB cable</b> (incl.)</li> <li>• with battery level indicator</li> <li>• with universal bracket up to Ø 31.8 mm</li> <li>• on Smart eurohole card</li> </ul>	 <p><b>800 LUMEN</b></p> <p>Ohne deutsches Prüfzeichen - Verkauf und Nutzung im Geltungsbereich der StVZO (Deutschland) unzulässig (Abgabe nur an außerdeutsche Kunden).</p> <p>UVP 75,90 €</p>
<b>220465</b> 60/30	<b>AKKULAMPE</b> <b>›TOURING 25‹</b> <ul style="list-style-type: none"> <li>• <b>3 CREE Hochleistungs-LED</b></li> <li>• 25 Lux</li> <li>• 4 Funktionen (3x Dauer- und 1x Blinklicht) inkl. <b>Tagesfahrlicht</b></li> <li>• Lithium-Polymer-Akku mit 1.000 mAh</li> <li>• Leuchtdauer: 2 - 30 Stunden</li> <li>• <b>wasserabweisend</b></li> <li>• aufladbar über <b>USB-Kabel</b> (inkl.)</li> <li>• mit <b>Batterie- und Ladezustandsanzeige</b></li> <li>• mit QR-Clip-on-Halter bis Ø 31,8 mm</li> <li>• auf Smart Eurolochkarte</li> </ul>	<b>RECHARGEABLE LAMP</b> <b>›TOURING 25‹</b> <ul style="list-style-type: none"> <li>• <b>3 CREE high power LED</b></li> <li>• 25 Lux</li> <li>• 4 functions (3x steady and 1x flashing light) incl. <b>daytime running light</b></li> <li>• rechargeable Lithium Polymer battery with 1,000 mAh</li> <li>• run time: 2 - 30 hours</li> <li>• <b>water resistant</b></li> <li>• rechargeable by <b>USB cable</b> (incl.)</li> <li>• with <b>battery level and charge control indicator</b></li> <li>• with QR clip-on bracket up to Ø 31.8 mm</li> <li>• on Smart eurohole card</li> </ul>	 <p><b>BATTERY LEVEL / CHARGE CONTROL INDICATOR</b></p> <p><b>25 LUX</b></p> <p>Ohne deutsches Prüfzeichen - Verkauf und Nutzung im Geltungsbereich der StVZO (Deutschland) unzulässig (Abgabe nur an außerdeutsche Kunden).</p> <p>UVP 34,90 €</p>
<b>220985</b> 50	<b>AKKULAMPE</b> <b>›POLARIS 200‹</b> <ul style="list-style-type: none"> <li>• <b>2 Watt Hochleistungs-LED</b></li> <li>• <b>200 Lumen</b></li> <li>• seitlich abstrahlendes, oranges Sicherheitslicht</li> <li>• 3 Funktionen (2x Dauer- und 1x Blinklicht)</li> <li>• aufladbar über <b>USB-Kabel</b> (inkl.)</li> <li>• Lithium-Polymer Akku</li> <li>• Leuchtdauer: 2,5 - 40 h</li> <li>• mit universellem Halter bis Ø 31,8 mm (Art. 223508)</li> <li>• auf Smart Eurolochkarte</li> </ul>	<b>RECHARGEABLE LAMP</b> <b>›POLARIS 200‹</b> <ul style="list-style-type: none"> <li>• <b>2 Watt high power LED</b></li> <li>• <b>200 lumen</b></li> <li>• laterally radiating, orange safety light</li> <li>• 3 functions (2x steady and 1x flashing light)</li> <li>• rechargeable by <b>USB cable</b> (incl.)</li> <li>• rechargeable Lithium Polymer battery</li> <li>• run time: 2.5 - 40 hours</li> <li>• with universal bracket up to Ø 31.8 mm (art. 223508)</li> <li>• on Smart eurohole card</li> </ul>	 <p><b>2 WATT 200 LUMEN</b></p> <p>Ohne deutsches Prüfzeichen - Verkauf und Nutzung im Geltungsbereich der StVZO (Deutschland) unzulässig (Abgabe nur an außerdeutsche Kunden).</p> <p>UVP 30,90 €</p>

ART.-NR. 	BESCHREIBUNG	DESCRIPTION	
<b>220841</b> 50/25	<b>AKKULAMPE</b> <b>› RAYS 150‹</b> <ul style="list-style-type: none"> <li>• 1  LED</li> <li>• <b>150 Lumen</b></li> <li>• 27 Lux</li> <li>• mit <b>deutschem Prüfzeichen</b></li> <li>• Leuchtdauer: ca. 2 Stunden</li> <li>• aufladbar über <b>USB-Kabel</b> (inkl.)</li> <li>• mit Batterie- und Ladezustandsanzeige</li> <li>• <b>klein aber fein</b>, nur <b>31 g</b></li> <li>• mit 360° drehbarem, universellem Gummiband-Halter bis Ø 31,8 mm</li> <li>• auf Smart Eurolochkarte</li> </ul>	<b>RECHARGEABLE LAMP</b> <b>› RAYS 150‹</b> <ul style="list-style-type: none"> <li>• 1  LED</li> <li>• <b>150 lumen</b></li> <li>• 27 Lux</li> <li>• with <b>German approval number</b></li> <li>• run time: approx. 2 hours</li> <li>• rechargeable by <b>USB cable</b> (incl.)</li> <li>• with battery level and charge control indicator</li> <li>• <b>small but fine</b>, only <b>31 g</b></li> <li>• with 360° turnable, universal rubber-band bracket up to Ø 31.8 mm</li> <li>• on Smart eurohole card</li> </ul>	        <p>UVP 24,90 €</p>
<b>220980</b> 40/20	<b>BATTERIELAMPE</b> <b>› TOURING 30‹</b> <ul style="list-style-type: none"> <li>• 1 weiße Hochleistungs-LED</li> <li>• mit <b>deutschem Prüfzeichen</b></li> <li>• <b>30 Lux</b></li> <li>• Leuchtdauer: ca. 4 Stunden</li> <li>• Batteriezustandsanzeige</li> <li>• mit universellem Halter bis Ø 31,8 mm (Art. 223508)</li> <li>• inkl. Batterien (3x AAA)</li> <li>• auf Smart Eurolochkarte</li> </ul>	<b>BATTERY LAMP</b> <b>› TOURING 30‹</b> <ul style="list-style-type: none"> <li>• 1 white high power LED</li> <li>• with <b>German approval number</b></li> <li>• <b>30 Lux</b></li> <li>• run time: approx. 4 hours</li> <li>• battery level indicator</li> <li>• with universal bracket up to Ø 31.8 mm (art. 223508)</li> <li>• incl. batteries (3x AAA)</li> <li>• on Smart eurohole card</li> </ul>	     <p>UVP 19,90 €</p>
<b>220201</b> 50/10	<b>BATTERIELAMPE</b> › NINE 80‹ <ul style="list-style-type: none"> <li>• 1 weiße <b>Hochleistungs-LED</b></li> <li>• <b>80 Lumen</b></li> <li>• 15 Lux</li> <li>• 2 Funktionen (Dauer- und Blinklicht)</li> <li>• Laufzeit: bis <b>32 Stunden</b></li> <li>• mit QR-Clip-on-Halter (Art. 220864) bis Ø 31,8 mm</li> <li>• nur <b>27 g</b></li> <li>• inkl. Batterien (2x AAA)</li> <li>• in Smart Blisterverpackung</li> </ul> <p>Ohne deutsches Prüfzeichen - Verkauf und Nutzung im Geltungsbereich der StVZO (Deutschland) unzulässig (Abgabe nur an außerdeutsche Kunden).</p>	<b>BATTERY LAMP</b> › NINE 80‹ <ul style="list-style-type: none"> <li>• 1 white <b>high power LED</b></li> <li>• <b>80 lumen</b></li> <li>• 15 Lux</li> <li>• 2 functions (steady and flashing light)</li> <li>• running time: up to <b>32 hours</b></li> <li>• with QR clip-on bracket (art. 220864) up to Ø 31.8 mm</li> <li>• only <b>27 g</b></li> <li>• incl. batteries (2x AAA)</li> <li>• in Smart blister packaging</li> </ul> <p>UVP 13,90 €</p>	    
<b>220911</b> 50/10 <b>NICE PRICE</b>	<b>BATTERIELAMPE</b> <b>› POLARIS 3‹</b> <ul style="list-style-type: none"> <li>• <b>3 SMD LEDs</b></li> <li>• 2 Funktionen (Dauer- und Blinklicht)</li> <li>• Laufzeit: bis <b>180 Stunden</b></li> <li>• <b>optische Linse</b> für fokussierte Ausleuchtung</li> <li>• mit QR-Clip-on-Halter bis Ø 31,8 mm (Art. 220818)</li> <li>• auch als <b>Mini-Taschenlampe</b> verwendbar</li> <li>• inkl. Batterien (2x AA)</li> <li>• in Smart Blisterverpackung</li> </ul> <p>Ohne deutsches Prüfzeichen - Verkauf und Nutzung im Geltungsbereich der StVZO (Deutschland) unzulässig (Abgabe nur an außerdeutsche Kunden).</p>	<b>BATTERY LAMP</b> <b>› POLARIS 3‹</b> <ul style="list-style-type: none"> <li>• <b>3 SMD LEDs</b></li> <li>• 2 functions (steady and flashing light)</li> <li>• running time: up to <b>180 hours</b></li> <li>• <b>optical lens</b> for focused illumination</li> <li>• with QR clip-on bracket up to Ø 31.8 mm (art. 220818)</li> <li>• can also be used as a <b>mini torch</b></li> <li>• incl. batteries (2x AA)</li> <li>• in Smart blister packaging</li> </ul> <p>UVP 12,90 €</p>	 



ART.-NR. 	BESCHREIBUNG	DESCRIPTION	
<b>221512</b> 100/50	<b>BLINKLICHT ›TWO EYES‹</b> <ul style="list-style-type: none"> <li>• <b>extreme Sichtbarkeit</b> durch <b>2 rote 0,5-Watt Superflash LEDs</b></li> <li>• mit Universalschellen für Sattelstützen und Sitzrohrstreben von Ø 18 bis 31,8 mm (Art. 223502)</li> <li>• mit integriertem Gürtelclip</li> <li>• auf Smart Eurolochkarte</li> </ul> <ul style="list-style-type: none"> <li>• 3 Funktionen (2x Dauerlicht und 1x <b>Soft-Blink-Modus</b>)</li> <li>• Laufzeit: bis <b>60 Stunden</b></li> <li>• inkl. Batterien (2x AAA)</li> </ul>	<b>FLASHING LIGHT ›TWO EYES‹</b> <ul style="list-style-type: none"> <li>• <b>extreme visibility</b> by <b>2 red 0.5 Watt Superflash LEDs</b></li> <li>• with universal clamp for seat pillar and seat stay from Ø 18 up to 31.8 mm (art. 223502)</li> <li>• with integrated belt clip</li> <li>• on Smart eurohole card</li> </ul> <ul style="list-style-type: none"> <li>• 3 functions (2x steady light and 1x <b>soft flashing mode</b>)</li> <li>• running time: up to <b>60 hours</b></li> <li>• incl. batteries (2x AAA)</li> </ul>	 <p>UVP 18,90 €</p>
<b>221515</b> 100/50	<ul style="list-style-type: none"> <li>• mit Lithium-Polymer <b>Akku</b> und <b>Micro-USB-Ladekabel</b></li> <li>• 4 Funktionen (3x Dauer- und 1x Blinklicht)</li> <li>• Laufzeit: bis <b>25 Stunden</b></li> </ul> <p>Ohne deutsches Prüfzeichen - Verkauf und Nutzung im Geltungsbereich der StVZO (Deutschland) unzulässig (Abgabe nur an außerdeutsche Kunden).</p>	<ul style="list-style-type: none"> <li>• with lithium polymer <b>rechargeable battery</b> and <b>micro USB charge cable</b></li> <li>• 4 functions (3x steady and 1x flashing light)</li> <li>• running time: up to <b>25 hours</b></li> </ul> <p>UVP 29,90 €</p>	
<b>221522</b> 100/20	<b>AKKUBLINKLICHT ›ACRUX‹</b> <ul style="list-style-type: none"> <li>• <b>7 superhelle rote LEDs</b></li> <li>• <b>10 Lumen</b></li> <li>• 3 Funktionen (2x Dauer- und 1x Blinklicht)</li> <li>• Lithium-Polymer Akku (3,7 V / 440 mAh)</li> <li>• Batterie- und Ladezustandsanzeige</li> <li>• Universal Clip-On Gummiband-Halter Ø 22 - 31,8 mm</li> <li>• Winkel des Halters einstellbar</li> <li>• werkzeuglose Montage</li> <li>• aufladbar über <b>Micro-USB-Kabel</b> (inkl.)</li> <li>• Laufzeit: bis <b>11 Stunden</b></li> <li>• nur <b>23g</b></li> <li>• in Smart Eurolochbox</li> </ul> <p>Ohne deutsches Prüfzeichen - Verkauf und Nutzung im Geltungsbereich der StVZO (Deutschland) unzulässig (Abgabe nur an außerdeutsche Kunden).</p>	<b>RECHARGEABLE FLASHING LIGHT ›ACRUX‹</b> <ul style="list-style-type: none"> <li>• <b>7 super bright red LEDs</b></li> <li>• <b>10 lumen</b></li> <li>• 3 functions (2x steady and 1x flashing light)</li> <li>• Lithium-Polymer Akku (3.7 V / 440 mAh)</li> <li>• battery level and charge control indicator</li> <li>• universal clip-on rubber bracket for Ø 22 - 31.8 mm</li> <li>• adjustable angle of the bracket</li> <li>• toolless mounting</li> <li>• rechargeable by <b>Micro USB cable</b> (incl.)</li> <li>• running time: up to <b>11 hours</b></li> <li>• only <b>23 g</b></li> <li>• in Smart eurohole box</li> </ul> <p>UVP 22,90 €</p>	
<b>221516</b> 100/50	<b>BATTERIERÜCKLICHT ›LIGHT BAR 28‹</b> <ul style="list-style-type: none"> <li>• <b>COB Hochleistungsleuchtband</b> mit <b>28 LED-Chips</b></li> <li>• mit <b>deutschem Prüfzeichen</b></li> <li>• Laufzeit: bis <b>24 Stunden</b></li> <li>• Batteriezustandsanzeige</li> <li>• Abstrahlwinkel: <b>220 Grad</b></li> <li>• mit Halter Ø 31,8 mm</li> <li>• inkl. Batterien (2x AAA)</li> <li>• mit integriertem Gürtelclip</li> <li>• auf Smart Eurolochkarte</li> </ul>	<b>BATTERY REAR LIGHT ›LIGHT BAR 28‹</b> <ul style="list-style-type: none"> <li>• <b>COB high performance light band</b> with <b>28 LED chips</b></li> <li>• with <b>German approval number</b></li> <li>• running time: up to <b>24 hours</b></li> <li>• battery level indicator</li> <li>• radiation angle: <b>220 degrees</b></li> <li>• with bracket Ø 31.8 mm</li> <li>• incl. batteries (2x AAA)</li> <li>• with integrated belt clip</li> <li>• on Smart eurohole card</li> </ul> <p>UVP 16,90 €</p>	

ART.-NR. 	BESCHREIBUNG	DESCRIPTION	
<b>220533</b> 100	<b>BATTERIEBLINKLICHT ›SUPERFLASH 0,5 WATT‹</b> <ul style="list-style-type: none"> <li>• <b>3 rote LEDs</b>, davon eine <b>0,5-Watt Hochleistungs-LED mit Superflash</b> Funktion für hervorragende <b>Sichtbarkeit bis über 1.000 m</b></li> <li>• 2 Funktionen (Dauer- und Blinklicht)</li> <li>• Laufzeit: bis <b>140 Stunden</b></li> <li>• Schalter im Gehäuse integriert, dadurch <b>wasserdicht</b></li> <li>• mit Universalschellen für Sattelstützen und Sitzrohrstreben von Ø 18 bis 31,8 mm (Art. 223502)</li> <li>• mit integriertem Gürtelclip</li> <li>• inkl. Batterien (2x AAA)</li> <li>• auf Smart Eurolochkarte</li> </ul> <p>Ohne deutsches Prüfzeichen - Verkauf und Nutzung im Geltungsbereich der StVZO (Deutschland) unzulässig (Abgabe nur an außerdeutsche Kunden).</p>	<b>BATTERY FLASHING LIGHT ›SUPERFLASH 0,5 WATT‹</b> <ul style="list-style-type: none"> <li>• <b>3 red LEDs</b>, one with <b>0.5 Watt high power LED with Superflash</b> function for outstanding <b>visibility up to 1,000 metres</b></li> <li>• 2 functions (steady and flashing light)</li> <li>• running time: up to <b>140 hours</b></li> <li>• switch integrated into the housing, thus <b>waterproof</b></li> <li>• with universal clamps for seat pillar and seat stay from Ø 18 up to 31.8 mm (art. 223502)</li> <li>• with integrated belt clip</li> <li>• incl. batteries (2x AAA)</li> <li>• on Smart eurohole card</li> </ul> <p>UVP 16,90 €</p>	 <p>GENUINE NICHIA LED™ U.S. Pat. 5,998,925</p> <p>0,5 WATT</p>
<b>221519</b> 100/50	<b>BATTERIELAMPE ›TRAIL‹</b> <ul style="list-style-type: none"> <li>• <b>1 rote Hochleistungs-LED</b></li> <li>• Laufzeit: bis <b>80 Stunden</b></li> <li>• mit <b>deutschem Prüfzeichen</b></li> <li>• <b>wasserdicht</b> gemäß IP65</li> <li>• mit Halter von Ø 16 bis 31,8 mm</li> <li>• mit integriertem Clip-on-Halter für Trikottasche, Gürtel, ...</li> <li>• inkl. Batterien (2x AAA)</li> <li>• auf Smart Eurolochkarte</li> </ul>	<b>BATTERY LAMP ›TRAIL‹</b> <ul style="list-style-type: none"> <li>• <b>1 red super bright LED</b></li> <li>• running time: up to <b>80 hours</b></li> <li>• with <b>German approval number</b></li> <li>• <b>waterproof</b> according IP65</li> <li>• with bracket from Ø 16 up to 31.8 mm</li> <li>• with integrated clip-on bracket for jersey pocket, belt, ...</li> <li>• incl. batteries (2x AAA)</li> <li>• on Smart eurohole card</li> </ul> <p>UVP 13,90 €</p>	 <p>GENUINE NICHIA LED™ U.S. Pat. 5,998,925</p>
<b>221521</b> 100/50	<b>RÜCKLICHT</b> <ul style="list-style-type: none"> <li>• <b>1 superhelle rote LED</b></li> <li>• <b>Abstrahlwinkel: 220°</b></li> <li>• wasserdicht</li> <li>• mit Batteriezustandsanzeige</li> <li>• mit integriertem Gürtelclip</li> <li>• auf Smart Eurolochkarte</li> </ul> <b>›Star USB‹</b> <ul style="list-style-type: none"> <li>• mit <b>deutschem Prüfzeichen</b></li> <li>• Lithium-Ionen-Akku (3,7V/350 mAh)</li> <li>• mit Universalschellen für Sattelstützen (Ø 23 - 33 mm)</li> <li>• mit Ladezustandsanzeige</li> <li>• aufladbar über <b>Micro-USB Kabel (inkl.)</b></li> </ul>	<b>REAR LIGHT</b> <ul style="list-style-type: none"> <li>• <b>1 super bright red LED</b></li> <li>• <b>radiation angle: 220 degrees</b></li> <li>• waterproof</li> <li>• with battery level indicator</li> <li>• with integrated belt clip</li> <li>• on Smart eurohole card</li> </ul> <b>›Star USB‹</b> <ul style="list-style-type: none"> <li>• with <b>German approval number</b></li> <li>• rechargeable Lithium Ion battery (3.7 V/350 mAh)</li> <li>• with universal clamps for seat pillars (Ø 23 - 33 mm)</li> <li>• with charge control indicator</li> <li>• rechargeable by <b>micro USB cable (incl.)</b></li> </ul> <p>UVP 14,90 €</p>	 <p>GENUINE NICHIA LED™ U.S. Pat. 5,998,925</p>
<b>221504</b> 100/50	<b>›Star‹</b> <ul style="list-style-type: none"> <li>• mit <b>deutschem und dänischem Prüfzeichen</b></li> <li>• mit Universalschellen für Sattelstützen (Ø 23 - 33 mm)</li> <li>• bis <b>80 Stunden</b> Laufzeit</li> <li>• inkl. Batterien (2x AAA)</li> </ul>	<b>›Star‹</b> <ul style="list-style-type: none"> <li>• with <b>German and Danish approval number</b></li> <li>• with universal clamps for seat pillars (Ø 23 - 33 mm)</li> <li>• up to <b>80 hours</b> run time</li> <li>• incl. batteries (2x AAA)</li> </ul> <p>UVP 11,90 €</p>	 <p>GENUINE NICHIA LED™ U.S. Pat. 5,998,925</p>
<b>221520</b> 100/50	<b>BATTERIERÜCKLICHT ›DIAMOND‹</b> <ul style="list-style-type: none"> <li>• <b>extreme Helligkeit durch 3 rote SMD (Surface Mount Device) LEDs</b></li> <li>• ca. <b>15 Lumen</b></li> <li>• gute <b>seitliche Sichtbarkeit</b></li> <li>• 3 Funktionen (1x Dauer- und 2x Blinklicht)</li> <li>• bis zu <b>260 Stunden</b> Laufzeit</li> <li>• mit Universalschellen für Sitzrohrstrebe und Sattelstütze (Ø 23 - 33 mm)</li> <li>• inkl. Batterien (2x AAA)</li> <li>• auf Smart Eurolochkarte</li> </ul> <p>Ohne deutsches Prüfzeichen - Verkauf und Nutzung im Geltungsbereich der StVZO (Deutschland) unzulässig (Abgabe nur an außerdeutsche Kunden).</p>	<b>BATTERY REAR LIGHT ›DIAMOND‹</b> <ul style="list-style-type: none"> <li>• <b>extreme bright trough 3 red SMD (Surface Mount Device) LEDs</b></li> <li>• approx. <b>15 lumen</b></li> <li>• good <b>lateral visibility</b></li> <li>• 3 functions (1x steady and 2x flashing light)</li> <li>• up to <b>260 hours</b> run time</li> <li>• mit universal clamps for seat stay and seat pillar (Ø 23 - 33 mm)</li> <li>• incl. batteries (2x AAA)</li> <li>• on Smart euroholecard</li> </ul> <p>UVP 7,90 €</p>	 <p>GENUINE NICHIA LED™ U.S. Pat. 5,998,925</p>

ART.-NR. 	BESCHREIBUNG	DESCRIPTION	
<b>221500</b> 100/50	<b>BATTERIEBLINKLICHT</b> <ul style="list-style-type: none"> <li>• Leuchtweite <b>600 m</b> durch <b>3 superhelle rote SMD-LEDs</b> mit <b>50 % mehr Leuchtkraft</b></li> <li>• 3 Funktionen (1x Dauer- und 2x Blinklicht)</li> <li>• Laufzeit: bis <b>260 Stunden</b></li> <li>• mit Universalschelle für Sattelstützen Ø 23,0 - 33,0 mm</li> <li>• wasserdicht</li> <li>• inkl. Batterien (2x AAA)</li> <li>• mit integriertem Gürtelclip</li> <li>• auf Smart Eurolochkarte</li> </ul>	<b>BATTERY FLASHING LIGHT</b> <ul style="list-style-type: none"> <li>• <b>600 m</b> lighting-power by <b>3 super bright red SMD LEDs</b> with <b>50 % more brightness</b></li> <li>• 3 functions (1x steady and 2x flashing light)</li> <li>• running time: up to <b>260 hours</b></li> <li>• with universal clamp for seat pillars Ø 23.0 - 33.0 mm</li> <li>• waterproof</li> <li>• incl. batteries (2x AAA)</li> <li>• with integrated belt clip</li> <li>• on Smart eurohole card</li> </ul>	  <p style="text-align: right;">UVP 5,90 €</p>
<b>220500</b> 100/20	<ul style="list-style-type: none"> <li>• <b>1 weiße, extrem helle SMD-LED</b></li> <li>• 15 Lumen</li> <li>• 2 Funktionen (Dauer- und Blinklicht)</li> <li>• Laufzeit: bis <b>140 Stunden</b></li> <li>• mit Clip-on-Halter für Lenker</li> <li>• inkl. Batterien (2x AAA)</li> <li>• mit integriertem Gürtelclip</li> <li>• in Smart Blisterverpackung</li> </ul> <p><small>Ohne deutsches Prüfzeichen - Verkauf und Nutzung im Geltungsbereich der StVZO (Deutschland) unzulässig (Abgabe nur an außerdeutsche Kunden).</small></p>	<ul style="list-style-type: none"> <li>• <b>1 white, super bright SMD LED</b></li> <li>• 15 lumen</li> <li>• 2 functions (steady and flashing light)</li> <li>• running time: up to <b>140 hours</b></li> <li>• with clip-on bracket for handlebar</li> <li>• incl. batteries (2x AAA)</li> <li>• with integrated belt clip</li> <li>• in Smart blister packaging</li> </ul> <p><small>Ohne deutsches Prüfzeichen - Verkauf und Nutzung im Geltungsbereich der StVZO (Deutschland) unzulässig (Abgabe nur an außerdeutsche Kunden).</small></p>	  <p style="text-align: right;">UVP 6,90 €</p>
<b>221507</b> 48/24 set	<b>BATTERIEBLINKLICHT-SET</b> <ul style="list-style-type: none"> <li>• für vorne und hinten</li> <li>• Art. 221500 + Art. 220500</li> <li>• inkl. Batterien (4x AAA)</li> <li>• mit integriertem Gürtelclip</li> <li>• Set in Smart Blisterverpackung</li> </ul> <p><small>Ohne deutsches Prüfzeichen - Verkauf und Nutzung im Geltungsbereich der StVZO (Deutschland) unzulässig (Abgabe nur an außerdeutsche Kunden).</small></p>	<b>BATTERY FLASHING LIGHT SET</b> <ul style="list-style-type: none"> <li>• for front and rear</li> <li>• art. 221500 + art. 220500</li> <li>• incl. batteries (4x AAA)</li> <li>• with integrated belt clip</li> <li>• set in Smart blister packaging</li> </ul> <p><small>Ohne deutsches Prüfzeichen - Verkauf und Nutzung im Geltungsbereich der StVZO (Deutschland) unzulässig (Abgabe nur an außerdeutsche Kunden).</small></p>	  <p style="text-align: right;">UVP 11,90 €</p>

# SHIMANO

SHIMANO  
DEORE



ART.-NR. 	BESCHREIBUNG	DESCRIPTION	
<b>220984</b> 40/20 set	<b>BATTERIELEUCHTEN-SET TOURING 30 SET</b> <ul style="list-style-type: none"> <li>inkl. Batterien (3x AAA / 2x AAA)</li> <li>auf Smart Eurolochkarte</li> </ul> <p>Frontlicht ›Touring 30‹ (Art. 220980)</p> <ul style="list-style-type: none"> <li>1 weiÙe Hochleistungs-LED</li> <li><b>mit deutschem Prfzeichen</b></li> <li><b>30 Lux</b></li> <li>Batteriezustandsanzeige</li> <li>mit universellem Halter bis Ø 31,8 mm (Art. 223508)</li> </ul> <p>Rcklicht ›Star‹ (Art. 221504)</p> <ul style="list-style-type: none"> <li><b>1 superhelle rote LED</b></li> <li>mit <b>deutschem</b> und <b>dnischem Prfzeichen</b></li> <li><b>Abstrahlwinkel: 220°</b></li> <li>mit Universalschellen fr Sattelsttzen Ø 23 bis 33 mm</li> <li>wasserdicht</li> <li>bis <b>80 Stunden</b> Laufzeit</li> <li>mit Batteriezustandsanzeige</li> <li>mit integriertem Grtelclip</li> </ul>	<b>BATTERY LAMP SET TOURING 30 SET</b> <ul style="list-style-type: none"> <li>incl. batteries (3x AAA / 2x AAA)</li> <li>on Smart eurohole card</li> </ul> <p>front light ›Touring 30‹ (art. 220980)</p> <ul style="list-style-type: none"> <li>1 white high performance LED</li> <li><b>with German approval number</b></li> <li><b>30 Lux</b></li> <li>battery level indicator</li> <li>with universal bracket up to Ø 31.8 mm (art. 223508)</li> </ul> <p>rear light ›Star‹ (art. 221504)</p> <ul style="list-style-type: none"> <li><b>1 super bright red LED</b></li> <li>with <b>German and Danish approval number</b></li> <li><b>radiation angle: 220 degrees</b></li> <li>with universal clamp for seat pillar Ø 23 up to 33 mm</li> <li>waterproof</li> <li>up to <b>80 hours</b> run time</li> <li>with battery level indicator</li> <li>with integrated belt clip</li> </ul> <p style="text-align: right;">UVP 30,90 €</p>	 <p><b>30 LUX</b></p>  
<b>220983</b> 50 set	<b>BATTERIELEUCHTEN-SET</b> <ul style="list-style-type: none"> <li>inkl. Batterien (2x AA / 2x AAA)</li> <li>auf Smart Eurolochkarte</li> </ul> <p>Frontlicht (Art. 220990)</p> <ul style="list-style-type: none"> <li>1 weiÙe <b>0,5 Watt Hochleistungs-LED</b></li> <li><b>80 Lumen</b></li> <li>2 Funktionen (Dauer- und Blinklicht)</li> <li>mit universellem Halter bis Ø 31,8 mm</li> </ul> <p>Blinklicht (Art. 220533)</p> <ul style="list-style-type: none"> <li><b>3 rote LEDs</b>, davon eine <b>0,5 Watt Hochleistungs-LED mit Superflash</b> Funktion fr <b>Sichtbarkeit bis ber 1.000 m</b></li> <li>2 Funktionen (Dauer- und Blinklicht)</li> <li>mit Universalschellen fr Sattelsttzen und Sitzrohrstreben von Ø 18 bis 31,8 mm (Art. 223502)</li> <li>mit integriertem Grtelclip</li> </ul> <p><small>Ohne deutsches Prfzeichen - Verkauf und Nutzung im Geltungsbereich der StVZO (Deutschland) unzulssig (Abgabe nur an auÙerdeutsche Kunden).</small></p>	<b>BATTERY LAMP SET</b> <ul style="list-style-type: none"> <li>incl. batteries (2x AA / 2x AAA)</li> <li>on Smart eurohole card</li> </ul> <p>front light (art. 220990)</p> <ul style="list-style-type: none"> <li>1 white <b>0.5 Watt super bright LED</b></li> <li><b>80 lumen</b></li> <li>2 functions (steady and flashing light)</li> <li>with universal bracket up to Ø 31.8 mm</li> </ul> <p>flashing light (art. 220533)</p> <ul style="list-style-type: none"> <li><b>3 red LEDs</b>, one with <b>0.5 Watt high power LED with Superflash</b> function for <b>visibility up to 1,000 m</b></li> <li>2 functions (steady and flashing light)</li> <li>with universal clamp for seat pillar and seat stay from Ø 18 up to 31.8 mm (art. 223502)</li> <li>with integrated belt clip</li> </ul> <p style="text-align: right;">UVP 27,90 €</p>	 <p><b>0,5 WATT</b></p> <p><b>0,5 WATT</b></p>  
<b>220927</b> 50/10 set <b>NICE PRICE</b>	<b>BATTERIELEUCHTEN-SET</b> <ul style="list-style-type: none"> <li>inkl. Batterien (2x AAA / 2x AA)</li> <li>auf Smart Eurolochkarte</li> </ul> <p>Frontlicht (Art. 220912)</p> <ul style="list-style-type: none"> <li><b>5 weiÙe SMD LEDs</b></li> <li>2 Funktionen (Dauer- und Blinklicht)</li> <li>fokussierte Ausleuchtung durch <b>optische Linsen</b></li> <li>QR-Clip-on-Halter bis Ø 31,8 mm (Art. 220818)</li> </ul> <p>Blinklicht (Art. 221500)</p> <ul style="list-style-type: none"> <li>Leuchtweite <b>600 m</b> durch <b>3 superhelle rote SMD-LEDs mit 50 % mehr Leuchtkraft</b></li> <li>3 Funktionen (1x Dauer- und 2x Blinklicht)</li> <li>mit Universalschellen fr Sattelsttzen von Ø 23 bis 33 mm</li> <li>mit integriertem Grtelclip</li> <li>wasserdicht</li> </ul> <p><small>Ohne deutsches Prfzeichen - Verkauf und Nutzung im Geltungsbereich der StVZO (Deutschland) unzulssig (Abgabe nur an auÙerdeutsche Kunden).</small></p>	<b>BATTERY LAMP SET</b> <ul style="list-style-type: none"> <li>incl. batteries (2x AAA / 2x AA)</li> <li>on Smart eurohole card</li> </ul> <p>front lamp (art. 220912)</p> <ul style="list-style-type: none"> <li><b>5 white SMD LEDs</b></li> <li>2 functions (steady and flashing light)</li> <li>focused illumination by <b>optical lenses</b></li> <li>QR clip-on bracket up to Ø 31.8 mm (art. 220818)</li> </ul> <p>flashing light (art. 221500)</p> <ul style="list-style-type: none"> <li><b>600 m</b> headlight range by <b>3 super bright red SMD LEDs with 50 % more brightness</b></li> <li>3 functions (1x steady and 2x flashing light)</li> <li>with universal clamps for seat pillars from Ø 23 up to 33 mm</li> <li>with integrated belt clip</li> <li>waterproof</li> </ul> <p style="text-align: right;">UVP 21,90 €</p>	 

ART.-NR.	BESCHREIBUNG	DESCRIPTION	
<b>220922</b> 50/10 set	<b>BATTERIELEUCHTEN-SET</b> <ul style="list-style-type: none"> <li>inkl. Batterien (2x AAA / 2x AA)</li> <li>auf Smart Eurolochkarte</li> </ul> <p>Frontlicht (Art. 220911)</p> <ul style="list-style-type: none"> <li><b>3 SMD LEDs</b></li> <li>2 Funktionen (Dauer- und Blinklicht)</li> <li>Laufzeit: bis <b>180 Stunden</b></li> <li><b>optische Linse</b> für fokussierte Ausleuchtung</li> <li>mit QR-Clip-on-Halter bis Ø 31,8 mm</li> <li>auch als <b>Mini-Taschenlampe</b> verwendbar</li> </ul> <p>Blinklicht (Art. 221500)</p> <ul style="list-style-type: none"> <li>Leuchtweite <b>600 m</b> durch <b>3 super-helle rote SMD-LEDs</b> mit <b>50 % mehr Leuchtkraft</b></li> <li>3 Funktionen (1x Dauer- und 2x Blinklicht)</li> <li>Laufzeit: bis zu <b>260 Stunden</b></li> <li>mit Universalschellen für Sattelstützen von Ø 23,0 bis 33,0 mm</li> <li>mit integriertem Gürtelclip</li> <li>wasserdicht</li> </ul> <p><small>Ohne deutsches Prüfzeichen - Verkauf und Nutzung im Geltungsbereich der StVZO (Deutschland) unzulässig (Abgabe nur an außerdeutsche Kunden).</small></p>	<b>BATTERY LAMP SET</b> <ul style="list-style-type: none"> <li>incl. batteries (2x AAA / 2x AA)</li> <li>on Smart eurohole card</li> </ul> <p>front lamp (art. 220911)</p> <ul style="list-style-type: none"> <li><b>3 SMD LEDs</b></li> <li>2 functions (steady and flashing light)</li> <li>running time: up to <b>180 hours</b></li> <li><b>optical lens</b> for focused illumination</li> <li>with QR clip-on bracket up to Ø 31.8 mm</li> <li>can also be used as a <b>mini torch</b></li> </ul> <p>flashing light (art. 221500)</p> <ul style="list-style-type: none"> <li><b>600 m</b> lighting-power by <b>3 super bright red SMD LEDs</b> with <b>50 % more brightness</b></li> <li>3 functions (1x steady and 2x flashing light)</li> <li>running time: up to <b>260 hours</b></li> <li>with universal clamps for seat pillars from Ø 23.0 up to 33.0 mm</li> <li>with integrated belt clip</li> <li>waterproof</li> </ul> <p style="text-align: right;">UVP 21,90 €</p>	
	<b>ERSATZ- ODER ZWEITHALTER</b>  zur Montage an integriertem Gürtelclip  <b>220868</b> 500/100 <ul style="list-style-type: none"> <li>für <b>Gepäckträger</b></li> <li>für Art. 220533, 221500/04/12/15/16/19/20/21</li> </ul> <b>223501</b> 250 <ul style="list-style-type: none"> <li>mit <b>Gummiband</b></li> <li>für Art. 220533, 221500/04/12/15/16/19/20/21</li> <li>für Sattelstützen, Sitzrohrstreben, ...</li> <li><b>Ø 16 - 35 mm</b></li> <li><b>schnelle werkzeuglose</b> Montage</li> </ul> <b>223502</b> 500/100 <ul style="list-style-type: none"> <li>für Art. 220533, 221500/04/12/15/16/19/20/21</li> <li>für <b>Ø 25 - 31,8 mm</b> bzw. für <b>Ø 18 mm</b></li> </ul>	<b>SPARE OR SECOND BRACKET</b>  for mounting to integrated belt clip  <ul style="list-style-type: none"> <li>for <b>carrier</b></li> <li>for art. 220533, 221500/04/12/15/16/19/20/21</li> </ul> <p style="text-align: right;">UVP 3,90 €</p> <ul style="list-style-type: none"> <li>with <b>rubber strap</b></li> <li>for art. 220533, 221500/04/12/15/16/19/20/21</li> <li>for seat pillars, seat stays, ...</li> <li><b>Ø 16 - 35 mm</b></li> <li><b>fast toolless</b> mounting</li> </ul> <p style="text-align: right;">UVP 4,90 €</p> <ul style="list-style-type: none"> <li>for art. 220533, 221500/04/12/15/16/19/20/21</li> <li>for <b>Ø 25 - 31.8 mm</b> and for <b>Ø 18 mm</b></li> </ul> <p style="text-align: right;">UVP 4,90 €</p>	
<b>223508</b> 500  <b>220818</b> 100  <b>223500</b> 250  <b>220861</b> 500/100	<ul style="list-style-type: none"> <li>mit <b>Gummiband</b></li> <li>für Art. 220911/80/83/84/85</li> <li>für <b>Ø 22,2 - 31,8 mm</b></li> <li><b>schnelle werkzeuglose</b> Montage</li> </ul> <ul style="list-style-type: none"> <li>mit <b>Rändelschraube</b></li> <li>für Art. 220911/22/27/465</li> <li>für <b>Ø 22,2 - 31,8 mm</b></li> <li><b>schnelle werkzeuglose</b> Montage</li> </ul> <ul style="list-style-type: none"> <li>mit <b>Gummiband</b></li> <li>für Art. 220500</li> <li>für Lenker, ... <b>Ø 16 - 31,8 mm</b></li> <li><b>schnelle werkzeuglose</b> Montage</li> </ul> <ul style="list-style-type: none"> <li>für Art. 220500</li> <li>für <b>Ø 20 - 25,4 mm</b></li> </ul>	<ul style="list-style-type: none"> <li>with <b>rubber strap</b></li> <li>for art. 220911/80/83/84/85</li> <li>for <b>Ø 22.2 - 31.8 mm</b></li> <li><b>fast toolless</b> mounting</li> </ul> <p style="text-align: right;">UVP 4,90 €</p> <ul style="list-style-type: none"> <li>with <b>knurled thumb screw</b></li> <li>for art. 220911/22/27/465</li> <li>for <b>Ø 22.2 - 31.8 mm</b></li> <li><b>fast toolless</b> mounting</li> </ul> <p style="text-align: right;">UVP 4,90 €</p> <ul style="list-style-type: none"> <li>with <b>rubber strap</b></li> <li>for art. 220500</li> <li>for handlebar, ..., <b>Ø 16 - 31.8 mm</b></li> <li><b>fast toolless</b> mounting</li> </ul> <p style="text-align: right;">UVP 4,90 €</p> <ul style="list-style-type: none"> <li>for art. 220500</li> <li>for <b>Ø 20 - 25.4 mm</b></li> </ul> <p style="text-align: right;">UVP 3,90 €</p>	

ART.-NR. 	BESCHREIBUNG	DESCRIPTION	
<b>220405</b> 100/20	<b>AKKULAMPE</b> <b>›APOLLON K 1.1 USB‹</b> <ul style="list-style-type: none"> <li>• 1 weiße  LED</li> <li>• mit <b>deutschem Prüfzeichen</b></li> <li>• <b>wasserfestes Silikongehäuse</b></li> <li>• Helligkeit <b>25 Lux</b></li> <li>• aufladbar über <b>USB-Kabel</b> (inkl.)</li> <li>• nur ca. 86 g</li> <li>• <b>Lithium-Polymer-Schnelllade-Akku</b> (3,7 V / 900 mAh)</li> <li>• Laufzeit: ca. 3 Stunden</li> <li>• mit Batterie- und Ladezustandsanzeige</li> <li>• integrierter <b>universeller Silikonhalter</b></li> <li>• <b>schnelle werkzeuglose</b> Montage, für Ø 22,2 - 32 mm</li> <li>• auf M-Wave Eurolochkarte</li> </ul>	<b>RECHARGEABLE LAMP</b> <b>›APOLLON K 1.1 USB‹</b> <ul style="list-style-type: none"> <li>• 1 white  LED</li> <li>• with <b>German approval number</b></li> <li>• <b>water resistant silicone housing</b></li> <li>• brightness <b>25 Lux</b></li> <li>• rechargeable by <b>USB cable</b> (incl.)</li> <li>• only approx. 86 g</li> <li>• <b>Lithium Polymer quick charge battery</b> (3.7 V / 900 mAh)</li> <li>• running time: approx. 3 hours</li> <li>• with battery level and charge control indicator</li> <li>• integrated <b>universal silicone bracket</b></li> <li>• <b>quick toolless</b> mounting, for Ø 22.2 - 32 mm</li> <li>• on M-Wave eurohole card</li> </ul>	     <p><b>25 LUX</b></p>   <p>UVP 34,90 €</p>
<b>220404</b> 100/20	<b>AKKULAMPE</b> <b>›APOLLON K 30 USB‹</b> <ul style="list-style-type: none"> <li>• 1 weiße <b>LED</b></li> <li>• 2 Funktionen: maximale Beleuchtung, Energiesparmodus</li> <li>• Helligkeit <b>30 / 15 Lux</b></li> <li>• mit <b>deutschem Prüfzeichen</b></li> <li>• 360° drehbarer Halter für Ø 19 - 35 mm (Art. 223559)</li> <li>• schnelle werkzeuglose Montage</li> <li>• mit Batterie- und Ladezustandsanzeige</li> <li>• nur ca. 51 g</li> <li>• <b>Lithium-Akku</b> (3,7 V / 1.200 mAh)</li> <li>• Laufzeit: ca. 3,5 - 7 Stunden</li> <li>• aufladbar über <b>USB-Kabel</b> (inkl.)</li> <li>• in M-Wave Blisterverpackung</li> </ul>	<b>RECHARGEABLE LAMP</b> <b>›APOLLON K 30 USB‹</b> <ul style="list-style-type: none"> <li>• 1 white <b>LED</b></li> <li>• 2 functions: maximum illumination, power saving mode</li> <li>• brightness <b>30 / 15 Lux</b></li> <li>• with <b>German approval number</b></li> <li>• 360° turnable bracket for Ø 19 - 35 mm (art. 223559)</li> <li>• quick toolless mounting</li> <li>• with battery level and charge control indicator</li> <li>• only approx. 51 g</li> <li>• <b>Lithium rechargeable battery</b> (3.7 V / 1,200 mAh)</li> <li>• running time: approx. 3.5 - 7 hours</li> <li>• rechargeable by <b>USB cable</b> (incl.)</li> <li>• in M-Wave blister packaging</li> </ul>	    <p><b>30 / 15 LUX</b></p>   <p>UVP 19,90 €</p>
<b>220421</b> 50/10 <b>NICE PRICE</b>	<b>AKKULAMPE</b> <b>›APOLLON 20 USB‹</b> <ul style="list-style-type: none"> <li>• 1 weiße <b>1 Watt LED</b> mit SST (<b>Soft Start Technology</b>)</li> <li>• hochwertiges <b>Aluminiumgehäuse</b></li> <li>• 3 Funktionen (2x Dauer- und 1x Blinklicht)</li> <li>• <b>Helligkeit bis zu 20 Lux, 95 Lumen</b></li> <li>• mit Batterie- und Ladezustandsanzeige</li> <li>• Lithium-Akku (3,7 V / 600 mAh)</li> <li>• Laufzeit: ca. 2 - 5 Stunden</li> <li>• aufladbar über <b>USB-Kabel</b> (inkl.)</li> <li>• Halter für Ø 22,2 - 35 mm (Art. 223551)</li> <li>• werkzeuglose Montage</li> <li>• nur ca. <b>54 g</b></li> <li>• auf M-Wave Eurolochkarte</li> </ul>	<b>RECHARGEABLE LAMP</b> <b>›APOLLON 20 USB‹</b> <ul style="list-style-type: none"> <li>• 1 white <b>1 Watt LED</b> with SST (<b>Soft Start Technology</b>)</li> <li>• high quality <b>aluminium</b> housing</li> <li>• 3 functions (2x steady and 1x flashing light)</li> <li>• <b>brightness levels up to 20 Lux, 95 Lumen</b></li> <li>• with battery level and charge control indicator</li> <li>• Lithium rechargeable battery (3.7 V / 600 mAh)</li> <li>• running time: approx. 2 - 5 hours</li> <li>• rechargeable by <b>USB cable</b> (incl.)</li> <li>• bracket for Ø 22.2 - 35 mm (art. 223551)</li> <li>• toolless mounting</li> <li>• only approx. <b>54 g</b></li> <li>• on M-Wave eurohole card</li> </ul>	   <p><b>1 WATT</b></p>   <p>UVP 17,90 €</p>

Ohne deutsches Prüfzeichen - Verkauf und Nutzung im Geltungsbereich der StVZO (Deutschland) unzulässig (Abgabe nur an außerdeutsche Kunden).





ART.-NR.	BESCHREIBUNG	DESCRIPTION	
<b>220887</b> 50/10	<b>BATTERIELAMPE</b> <b>›APOLLON A 1.2 3 WATT‹</b> <ul style="list-style-type: none"> <li>• 1 weiße, <b>ultrahelle 3 Watt LED</b></li> <li>• <b>Aluminiumgehäuse</b></li> <li>• 2 Funktionen (Dauer- und Blinklicht)</li> <li>• Laufzeit: ca. 2 Stunden</li> <li>• mit Dreh-Clip-on-Halter von Ø 22,2 - 31,8 mm (Art. 223541), werkzeuglose Montage</li> <li>• auch als Minitaschenlampe verwendbar</li> <li>• inkl. Batterien (4x AAA)</li> <li>• in M-Wave Kunststoffbox</li> </ul> <p>Ohne deutsches Prüfzeichen - Verkauf und Nutzung im Geltungsbereich der StVZO (Deutschland) unzulässig (Abgabe nur an außerdeutsche Kunden).</p>	<b>BATTERY LAMP</b> <b>›APOLLON A 1.2 3 WATT‹</b> <ul style="list-style-type: none"> <li>• 1 white, <b>ultra bright 3 Watt LED</b></li> <li>• <b>aluminium housing</b></li> <li>• 2 functions (steady and flashing light)</li> <li>• running time: approx. 2 hours</li> <li>• with twist clip-on bracket from Ø 22.2 - 31.8 mm (art. 223541), toolless mounting</li> <li>• can also be used as a mini torch</li> <li>• incl. batteries (4x AAA)</li> <li>• in M-Wave plastic box</li> </ul> <p>UVP 11,90 €</p>	   
<b>220998</b> 50	<b>BATTERIELAMPE</b> <b>›APOLLON A 1.3 3 WATT‹</b> <ul style="list-style-type: none"> <li>• 1 weiße  <b>3 Watt Hochleistungs-LED</b></li> <li>• <b>Zoomfunktion: Ausleuchtungsbereich bis zu 2000-fach stufenlos verstellbar</b></li> <li>• 3 Funktionen (2x Dauer- und 1x Blinklicht)</li> <li>• hochwertiges, gedichtetes <b>Aluminiumgehäuse</b></li> <li>• universeller QR-Clip-on-Halter Ø 20 - 28,6 mm (Art. 223514), werkzeuglose Montage</li> <li>• auch als Minitaschenlampe verwendbar</li> <li>• inkl. Batterien (3x AAA)</li> <li>• in M-Wave Blisterverpackung</li> </ul> <p>Ohne deutsches Prüfzeichen - Verkauf und Nutzung im Geltungsbereich der StVZO (Deutschland) unzulässig (Abgabe nur an außerdeutsche Kunden).</p>	<b>BATTERY LAMP</b> <b>›APOLLON A 1.3 3 WATT‹</b> <ul style="list-style-type: none"> <li>• 1 white  <b>3 Watt high power LED</b></li> <li>• <b>zoom function: illumination area seamlessly adjustable up to 2000 times</b></li> <li>• 3 functions (2x steady and 1x flashing light)</li> <li>• high quality sealed <b>aluminium housing</b></li> <li>• universal QR clip-on bracket Ø 20 - 28.6 mm (art. 223514), toolless mounting</li> <li>• also usable as mini torch</li> <li>• incl. batteries (3x AAA)</li> <li>• in M-Wave blister packaging</li> </ul> <p>UVP 11,90 €</p>	     
<b>220447</b> 100	<b>BATTERIELAMPE</b> <b>›APOLLON K 1.2‹</b> <ul style="list-style-type: none"> <li>• 1 weiße <b>Hochleistungs-LED</b></li> <li>• <b>Klartglasscheinwerfer</b></li> <li>• mit <b>deutschem Prüfzeichen</b></li> <li>• 2 Helligkeitsstufen: <b>30/15 Lux</b></li> <li>• Laufzeit: ca. 2 - 4 Stunden</li> <li>• nur 49 g (ohne Batterien)</li> <li>• mit Batteriezustandsanzeige</li> <li>• mit QR-Clip-on-Halter (Art. 223515) von Ø 22,2 - 31,8 mm, werkzeuglose Montage</li> <li>• inkl. Batterien (4x AAA)</li> <li>• in M-Wave Blisterverpackung</li> </ul> <p>Ohne deutsches Prüfzeichen - Verkauf und Nutzung im Geltungsbereich der StVZO (Deutschland) unzulässig (Abgabe nur an außerdeutsche Kunden).</p>	<b>BATTERY LAMP</b> <b>›APOLLON K 1.2‹</b> <ul style="list-style-type: none"> <li>• 1 white <b>super bright LED</b></li> <li>• <b>clear lens beam</b></li> <li>• with <b>German approval number</b></li> <li>• 2 brightness levels: <b>30/15 Lux</b></li> <li>• running time: approx. 2 - 4 hours</li> <li>• only 49 g (w/o batteries)</li> <li>• with battery level indicator</li> <li>• with QR clip-on bracket (art. 223515) from Ø 22.2 - 31.8 mm, toolless mounting</li> <li>• incl. batteries (4x AAA)</li> <li>• in M-Wave blister packaging</li> </ul> <p>UVP 10,90 €</p>	    
<b>220401</b> 100/20	<b>BATTERIELAMPE</b> ›APOLLON 2‹ <ul style="list-style-type: none"> <li>• 1 weiße <b>1 Watt LED</b></li> <li>• <b>60 Lumen</b></li> <li>• 3 Funktionen (1x Dauer- und 2x Blinklicht)</li> <li>• Laufzeit: ca. 10 - 20 Stunden</li> <li>• mit QR-Clip-On Halter bis Ø 31,8 mm</li> <li>• werkzeuglose Montage</li> <li>• inkl. Batterien (3x AAA)</li> <li>• auch als Minitaschenlampe verwendbar</li> <li>• in M-Wave Blisterverpackung</li> </ul> <p>Ohne deutsches Prüfzeichen - Verkauf und Nutzung im Geltungsbereich der StVZO (Deutschland) unzulässig (Abgabe nur an außerdeutsche Kunden).</p>	<b>BATTERY LAMP</b> ›APOLLON 2‹ <ul style="list-style-type: none"> <li>• 1 white <b>1 Watt LED</b></li> <li>• <b>60 Lumen</b></li> <li>• 3 functions (1x steady and 2x flashing light)</li> <li>• running time: approx. 10 - 20 hours</li> <li>• with QR clip-on bracket up to Ø 31.8 mm</li> <li>• toolless mounting</li> <li>• incl. batteries (3x AAA)</li> <li>• also useable as mini torch</li> <li>• in M-Wave blister packaging</li> </ul> <p>UVP 8,90 €</p>	   

ART.-NR. 	BESCHREIBUNG	DESCRIPTION	
<b>220957</b> 50/10	<b>BATTERIELAMPE</b> <b>›APOLLON 5.3‹</b> <ul style="list-style-type: none"> <li>• <b>5 weiße Hochleistungs-LEDs</b></li> <li>• 3 Funktionen (1x Dauer- und 2x Blinklicht)</li> <li>• extrem lange Leuchtdauer</li> <li>• fokussierte Ausleuchtung durch <b>optische Linsen</b></li> <li>• mit QR-Clip-on-Halter von Ø 22,2 - 31,8 mm, werkzeuglose Montage</li> <li>• auch als <b>Minitaschenlampe</b> verwendbar</li> <li>• inkl. Batterien (3x AAA)</li> <li>• in M-Wave Blisterverpackung</li> </ul> <p>Ohne deutsches Prüfzeichen - Verkauf und Nutzung im Geltungsbereich der StVZO (Deutschland) unzulässig (Abgabe nur an außerdeutsche Kunden).</p>	<b>BATTERY LAMP</b> <b>›APOLLON 5.3‹</b> <ul style="list-style-type: none"> <li>• <b>5 white super bright LEDs</b></li> <li>• 3 functions (1x steady and 2x flashing light)</li> <li>• extremely long run time</li> <li>• focused illumination by <b>optical lenses</b></li> <li>• with QR clip-on bracket from Ø 22.2 - 31.8 mm, toolless mounting</li> <li>• also useable as mini torch</li> <li>• incl. batteries (3x AAA)</li> <li>• in M-Wave blister packaging</li> </ul> <p>UVP 8,90 €</p>	  
<b>220941</b> 60/20	<b>BATTERIELAMPE</b> <b>›APOLLON A 9.1‹</b> <ul style="list-style-type: none"> <li>• <b>9 weiße LEDs</b></li> <li>• hochwertiges, <b>gedichtetes Aluminiumgehäuse</b></li> <li>• mit Universal-Clip-on-Halter Ø 22,2 - 28 mm</li> <li>• auch als <b>Minitaschenlampe</b> verwendbar</li> <li>• inkl. Batterien (3x AAA)</li> <li>• in M-Wave Blisterverpackung</li> </ul> <p>Ohne deutsches Prüfzeichen - Verkauf und Nutzung im Geltungsbereich der StVZO (Deutschland) unzulässig (Abgabe nur an außerdeutsche Kunden).</p>	<b>BATTERY LAMP</b> <b>›APOLLON A 9.1‹</b> <ul style="list-style-type: none"> <li>• <b>9 white LEDs</b></li> <li>• high-quality, <b>sealed aluminium housing</b></li> <li>• with universal clip-on bracket Ø 22.2 - 28 mm</li> <li>• also usable as <b>mini torch</b></li> <li>• incl. batteries (3x AAA)</li> <li>• in M-Wave blister packaging</li> </ul> <p>UVP 6,90 €</p>	 
<b>220942</b> 100/10	<b>BATTERIELAMPE</b> <b>›APOLLON 4.3‹</b> <ul style="list-style-type: none"> <li>• <b>4 weiße LEDs</b></li> <li>• 3 Funktionen (1x Dauer- und 2x Blinklicht)</li> <li>• Universalhalter passend für Ø 22,2 bis 31,8 mm</li> <li>• mit Ersatzgummi für Halter</li> <li>• werkzeuglose Montage</li> <li>• auch als <b>Minitaschenlampe</b> verwendbar</li> <li>• inkl. Batterien (3x AAA)</li> <li>• in M-Wave Blisterverpackung</li> </ul> <p>Ohne deutsches Prüfzeichen - Verkauf und Nutzung im Geltungsbereich der StVZO (Deutschland) unzulässig (Abgabe nur an außerdeutsche Kunden).</p>	<b>BATTERY LAMP</b> <b>›APOLLON 4.3‹</b> <ul style="list-style-type: none"> <li>• <b>4 white LEDs</b></li> <li>• 3 functions (1x steady and 2x flashing light)</li> <li>• universal bracket suitable for Ø 22.2 up to 31.8 mm</li> <li>• with replacement rubber for bracket</li> <li>• toolless mounting</li> <li>• also usable as <b>mini torch</b></li> <li>• incl. batteries (3x AAA)</li> <li>• in M-Wave blister packaging</li> </ul> <p>UVP 7,90 €</p>	  
<b>220545</b> 50/10	<b>AKKULAMPE</b> <b>›APOLLON DUAL 3.8 USB‹</b> <ul style="list-style-type: none"> <li>• <b>Front- und Rücklicht in einem: 2 weiße LEDs</b> vorne und <b>eine superhelle rote LED</b> hinten</li> <li>• maximale Lichtleistung vorne: 60 Lumen</li> <li>• <b>8 Funktionen</b> (5x Blinklicht und 3x Helligkeitsstufen der weißen LEDs)</li> <li>• mit Memoryfunktion</li> <li>• Lithium-Polymer Akku (3,7 V / 240 mAh)</li> <li>• Laufzeit: ca. 1,5 - 6 Stunden</li> <li>• nur <b>18 g</b></li> <li>• aufladbar über <b>USB-Kabel</b> (inkl.)</li> <li>• Batterie- und Ladezustandsanzeige</li> <li>• auch um <b>90° gedreht</b> montierbar</li> <li>• universeller Klettverschlusshalter für Helm, Lenker, Rahmen, Sattelstütze, ...</li> <li>• werkzeuglose Montage</li> <li>• in M-Wave Blisterverpackung</li> </ul> <p>Ohne deutsches Prüfzeichen - Verkauf und Nutzung im Geltungsbereich der StVZO (Deutschland) unzulässig (Abgabe nur an außerdeutsche Kunden).</p>	<b>RECHARGEABLE LAMP</b> <b>›APOLLON DUAL 3.8 USB‹</b> <ul style="list-style-type: none"> <li>• <b>front and rear light in one: 2 white LEDs</b> at the front and <b>one super bright red LED</b> at the back</li> <li>• maximum light output at the front: 60 lumen</li> <li>• <b>8 functions</b> (5x flashing light and 3x brightness levels of the white LEDs)</li> <li>• with memory function</li> <li>• rechargeable Lithium Polymer battery (3.7 V / 240 mAh)</li> <li>• running time: approx. 1.5 - 6 hours</li> <li>• only <b>18 g</b></li> <li>• rechargeable by <b>USB cable</b> (incl.)</li> <li>• battery level and charge control indicator</li> <li>• also mountable <b>turned by 90°</b></li> <li>• universal hook and loop fastener for helmet, handlebar, frame, seat tube, ...</li> <li>• toolless mounting</li> <li>• in M-Wave blister packaging</li> </ul> <p>UVP 16,90 €</p>	       

ART.-NR. 	BESCHREIBUNG	DESCRIPTION							
<b>220572</b> 100/20	<b>AKKURÜCKLICHT &gt;HELIOS K 1.1 USB&lt;</b> <ul style="list-style-type: none"> <li>• 1 rote <b>Hochleistungs-LED</b></li> <li>• mit <b>deutschem Prüfzeichen</b></li> <li>• schwarzes <b>Silikongehäuse</b></li> <li>• aufladbar über <b>USB-Kabel</b> (inkl.)</li> <li>• integrierter <b>universeller Silikonhalter</b></li> <li>• <b>schnelle werkzeuglose</b> Montage</li> <li>• mit Lithium-Ionen Akku (3,7 V / 160 mAh)</li> <li>• mit Batterie- und Ladezustandsanzeige</li> <li>• in M-Wave Blisterverpackung</li> </ul>	<b>RECHARGEABLE REAR LIGHT &gt;HELIOS K 1.1 USB&lt;</b> <ul style="list-style-type: none"> <li>• 1 red <b>high power LED</b></li> <li>• with <b>German approval number</b></li> <li>• black <b>silicone housing</b></li> <li>• rechargeable by <b>USB cable</b> (incl.)</li> <li>• integrated <b>universal silicone bracket</b></li> <li>• <b>quick toolless</b> mounting</li> <li>• with rechargeable Lithium Ion battery (3.7V / 160mAh)</li> <li>• with battery level and charge control indicator</li> <li>• in M-Wave blister packaging</li> </ul> <p style="text-align: right;">UVP 18,90 €</p>	<b>SILICONE</b>      						
<b>220559</b> 100 <b>NICE PRICE</b>	<b>AKKURÜCKLICHT &gt;HELIOS K 1.1 USB SL&lt;</b> <ul style="list-style-type: none"> <li>• 1 rote <b>LED</b></li> <li>• mit <b>deutschem Prüfzeichen</b></li> <li>• Halter für Ø 19 - 35 mm (Art. 223561)</li> <li>• Winkel des Halters einstellbar</li> <li>• <b>240°</b> Abstrahlwinkel</li> <li>• <b>klein</b> aber <b>fein</b>, nur <b>11 g</b> (ohne Halter)</li> <li>• schnelle werkzeuglose Montage</li> <li>• mit Batterie- und Ladezustandsanzeige</li> <li>• aufladbar über <b>USB-Kabel</b> (inkl.)</li> <li>• <b>Lithium-Polymer Akku</b> (3,7 V / 240 mAh)</li> <li>• Laufzeit: ca. 4 Stunden</li> <li>• in M-Wave Blisterverpackung</li> </ul>	<b>RECHARGEABLE REAR LIGHT &gt;HELIOS K 1.1 USB SL&lt;</b> <ul style="list-style-type: none"> <li>• 1 red <b>LED</b></li> <li>• with <b>German approval number</b></li> <li>• bracket for Ø 19 - 35 mm (art. 223561)</li> <li>• adjustable angle of the bracket</li> <li>• <b>240°</b> illumination angle</li> <li>• <b>small but mighty</b>, only <b>11 g</b> (without bracket)</li> <li>• quick toolless mounting</li> <li>• with battery level and charge control indicator</li> <li>• rechargeable by <b>USB cable</b> (incl.)</li> <li>• <b>rechargeable Lithium Polymer battery</b> (3.7 V / 240 mAh)</li> <li>• running time: approx. 4 hours</li> <li>• in M-Wave blister packaging</li> </ul> <p style="text-align: right;">UVP 10,90 €</p>	      						
<b>221037</b> 100/20	<b>BATTERIEBLINKLICHT &gt;HELIOS 2.3&lt;</b> <ul style="list-style-type: none"> <li>• <b>2x 0,5-Watt ultrahelle Superflash-LEDs</b></li> <li>• 3 Funktionen (1x Dauer- und 2x Blinklicht)</li> <li>• mit Universalschelle für Sattelstützen von Ø 25,4 - 31,8 mm</li> <li>• <b>90° drehbar</b></li> <li>• werkzeuglose Montage</li> <li>• inkl. Batterien (2x AAA)</li> <li>• in M-Wave Blisterverpackung</li> </ul> <p><small>Ohne deutsches Prüfzeichen - Verkauf und Nutzung im Geltungsbereich der StVZO (Deutschland) unzulässig (Abgabe nur an außerdeutsche Kunden).</small></p>	<b>BATTERY FLASHING LIGHT &gt;HELIOS 2.3&lt;</b> <ul style="list-style-type: none"> <li>• <b>2x 0.5-Watt superbright flash LEDs</b></li> <li>• 3 functions (1x steady and 2x flashing light)</li> <li>• with universal bracket for seat posts from Ø 25.4 - 31.8 mm</li> <li>• <b>90° turnable</b></li> <li>• toolless mounting</li> <li>• incl. batteries (2x AAA)</li> <li>• in M-Wave blister packaging</li> </ul> <p style="text-align: right;">UVP 8,90 €</p>	    						
<b>220513</b> 100/20	<b>BATTERIEBREMSLICHT &gt;HELIOS BRAKE&lt;</b> <ul style="list-style-type: none"> <li>• 1 superhelle rote LED</li> <li>• <b>leuchtet beim Zug des Bremshebels auf</b></li> <li>• 3 Funktionen (Blink-, Dauer- und Bremslicht)</li> <li>• für <b>Rennrad- und V-Bremse</b> geeignet</li> <li>• <b>werkzeuglose Montage</b></li> <li>• inkl. Batterie (CR 2032)</li> <li>• in M-Wave Blisterverpackung</li> </ul> <p><small>Ohne deutsches Prüfzeichen - Verkauf und Nutzung im Geltungsbereich der StVZO (Deutschland) unzulässig (Abgabe nur an außerdeutsche Kunden).</small></p>	<b>BATTERY BRAKE LIGHT &gt;HELIOS BRAKE&lt;</b> <ul style="list-style-type: none"> <li>• 1 super bright red LED</li> <li>• <b>lights up by the pull of the brake lever</b></li> <li>• 3 functions (flashing, steady and brake light)</li> <li>• suitable for <b>road and V-brake</b></li> <li>• <b>toolless mounting</b></li> <li>• incl. battery (CR 2032)</li> <li>• in M-Wave blister packaging</li> </ul> <p style="text-align: right;">UVP 6,90 €</p>	  <table border="1" style="width: 100%; text-align: center;"> <tr> <td><b>ROAD</b></td> <td><b>V-BRAKE</b></td> <td><b>MECHANICAL DISC</b></td> </tr> <tr> <td></td> <td></td> <td></td> </tr> </table> 	<b>ROAD</b>	<b>V-BRAKE</b>	<b>MECHANICAL DISC</b>			
<b>ROAD</b>	<b>V-BRAKE</b>	<b>MECHANICAL DISC</b>							



ART.-NR. 	BESCHREIBUNG	DESCRIPTION	
<b>221041</b> 100/20	<b>BATTERIEBLINKLICHT ›HELIOS 3.2 S‹</b> <ul style="list-style-type: none"> <li>• <b>3 rote LEDs, davon eine 0,5 Watt Hochleistungs-LED mit Superflash-Funktion</b> für exzellente Sichtbarkeit</li> <li>• 2 Funktionen (Dauer- und Blinklicht)</li> <li>• universeller, <b>90° drehbarer und winkelverstellbarer</b> Halter für Sattelstütze von Ø 25,4 - 31,8 mm</li> <li>• werkzeuglose Montage</li> <li>• inkl. Batterien (2x AAA)</li> <li>• in M-Wave Blisterverpackung</li> </ul> <p>Ohne deutsches Prüfzeichen - Verkauf und Nutzung im Geltungsbereich der StVZO (Deutschland) unzulässig (Abgabe nur an außerdeutsche Kunden).</p>	<b>BATTERY FLASHING LIGHT ›HELIOS 3.2 S‹</b> <ul style="list-style-type: none"> <li>• <b>3 red LEDs, thereof one 0.5 Watt high power LED with superflash function</b> for excellent visibility</li> <li>• 2 functions (steady and flashing light)</li> <li>• universal, <b>90° turnable and angle adjustable</b> bracket for seat post from Ø 25.4 - 31.8 mm</li> <li>• toolless mounting</li> <li>• incl. batteries (2x AAA)</li> <li>• in M-Wave blister packaging</li> </ul> <p>UVP 6,90 €</p>	  <p>0,5 WATT</p> <p>90°</p>
<b>220569</b> 100/20	<b>BATTERIERÜCKLICHT ›HELIOS K 1.1‹</b> <ul style="list-style-type: none"> <li>• 1 rote <b>Hochleistungs-SMD-LED</b></li> <li>• Universalhalter passend für Ø 25,4 - 31,8 mm (Art. 223516)</li> <li>• mit <b>deutschem Prüfzeichen</b></li> <li>• Laufzeit: bis zu 9,5 Stunden</li> <li>• inkl. Batterien (2x AAA)</li> <li>• mit Batteriezustandsanzeige</li> <li>• in M-Wave Blisterverpackung</li> </ul>	<b>BATTERY REAR LIGHT ›HELIOS K 1.1‹</b> <ul style="list-style-type: none"> <li>• 1 red <b>high power SMD LED</b></li> <li>• universal bracket suitable for Ø 25.4 - 31.8 mm (art. 223516)</li> <li>• with <b>German approval number</b></li> <li>• running time: up to 9.5 hours</li> <li>• incl. batteries (2x AAA)</li> <li>• with battery level indicator</li> <li>• in M-Wave blister packaging</li> </ul> <p>UVP 6,90 €</p>	  <p>geprüft DIN EN 60598-2</p>
<p><b>NICE PRICE</b></p> <b>221055</b> 100/10 • <b>221054</b> 200	<b>BATTERIERÜCKLICHT ›HELIOS K 1.1 RS‹</b> <ul style="list-style-type: none"> <li>• innovatives Design</li> <li>• mit <b>deutschem Prüfzeichen</b></li> <li>• nur <b>30 g</b></li> <li>• <b>230° sichtbar</b> durch transparentes Gehäuse</li> <li>• universeller Gummihalter Ø 22,2 - 30 mm</li> <li>• <b>werkzeuglose</b> Montage an der <b>Sattelstütze, Sitzrohr- oder Kettenstrebe</b> möglich</li> <li>• inkl. Batterien (2x CR 2032)</li> </ul> <p>auf M-Wave Eurolochkarte</p> <p>Montageverpackung</p>	<b>BATTERY REAR LIGHT ›HELIOS K 1.1 RS‹</b> <ul style="list-style-type: none"> <li>• innovative design</li> <li>• with <b>German approval number</b></li> <li>• only <b>30 g</b></li> <li>• <b>230° visible</b> because of transparent housing</li> <li>• universal rubber bracket Ø 22.2 - 30 mm</li> <li>• <b>toolless</b> mounting at the <b>seat post, seat tube or chain stay</b> possible</li> <li>• incl. batteries (2x CR 2032)</li> </ul> <p>on M-Wave eurohole card</p> <p>OEM</p> <p>UVP 4,90 €</p>	  <p>geprüft DIN EN 60598-2</p> <p>30 g</p>
<b>221040</b> 100/20	<b>BATTERIEBLINKLICHT ›ATLAS L.R‹</b> <ul style="list-style-type: none"> <li>• <b>3 rote LEDs</b></li> <li>• 3 Funktionen (1x Dauer- und 2x Blinklicht)</li> <li>• mit Halter (Art. 220824) für Sattelstütze und Gürtelclip</li> <li>• inkl. <b>Batterien</b> (2x AAA)</li> <li>• in M-Wave Blisterverpackung</li> </ul> <p>Ohne deutsches Prüfzeichen - Verkauf und Nutzung im Geltungsbereich der StVZO (Deutschland) unzulässig (Abgabe nur an außerdeutsche Kunden).</p>	<b>BATTERY FLASHING LIGHT ›ATLAS L.R‹</b> <ul style="list-style-type: none"> <li>• <b>3 red LEDs</b></li> <li>• 3 functions (1x steady and 2x flashing light)</li> <li>• with bracket (art. 220824) for seat post and belt clip</li> <li>• incl. <b>batteries</b> (2x AAA)</li> <li>• in M-Wave blister packaging</li> </ul> <p>UVP 3,90 €</p>	 

ART.-NR.	BESCHREIBUNG	DESCRIPTION	
<b>221034</b> 100/20	<b>BATTERIEBLINKLICHT</b> <b>›HELIOS 5.3‹</b> <ul style="list-style-type: none"> <li>• <b>5 ultrahelle SMD-LEDs</b></li> <li>• 3 Funktionen (1x Dauer- und 2x Blinklicht)</li> <li>• mit winkelverstellbarem Clip-on Gummibandhalter passend für Ø 25,4 - 31,8 mm</li> <li>• Licht <b>90° drehbar</b></li> <li>• inkl. Batterien (2x AAA)</li> <li>• in M-Wave Blisterverpackung</li> </ul>	<b>BATTERY FLASHING LIGHT</b> <b>›HELIOS 5.3‹</b> <ul style="list-style-type: none"> <li>• <b>5 superbright SMD LEDs</b></li> <li>• 3 functions (1x steady and 2x flashing light)</li> <li>• with angle-adjustable clip-on rubber bracket suitable for Ø 25.4 - 31.8 mm</li> <li>• light <b>90° turnable</b></li> <li>• incl. batteries (2x AAA)</li> <li>• in M-Wave blister packaging</li> </ul>	  
<b>220627</b> 100/20 <b>NICE PRICE</b>	<b>AKKU-BLINKLICHT</b> <b>›APOLLON MINI A USB‹</b> <ul style="list-style-type: none"> <li>• <b>hochwertiges Aluminiumgehäuse</b></li> <li>• 1 rote <b>0,5 Watt LED</b></li> <li>• 10 Lumen</li> <li>• aufladbar über <b>USB-Kabel</b> (inkl.)</li> <li>• Lithium-Akku (3,7 V / 220 mAh)</li> <li>• mit Batteriezustands- und Ladestandsanzeige</li> <li>• bis zu <b>30 Stunden Laufzeit</b></li> <li>• 3 Funktionen (1x Dauer- und 2x Blinklicht)</li> <li>• nur <b>26 g</b></li> <li>• universelle, werkzeuglose Montage durch elastisches Gummiband Ø 22,2 - 31,8 mm</li> <li>• in M-Wave Blisterverpackung</li> </ul>	<b>RECHARGEABLE FLASHING LIGHT</b> <b>›APOLLON MINI A USB‹</b> <ul style="list-style-type: none"> <li>• <b>high quality aluminium</b> housing</li> <li>• 1 red <b>0.5 Watt LED</b></li> <li>• 10 Lumen</li> <li>• rechargeable by <b>USB cable</b> (incl.)</li> <li>• rechargeable Lithium battery (3.7 V / 220 mAh)</li> <li>• with battery level and charge control indicator</li> <li>• up to <b>30 hours run time</b></li> <li>• 3 functions (1x steady and 2x flashing light)</li> <li>• only <b>26 g</b></li> <li>• universal, toolless mounting with elastic rubber strap Ø 22.2 - 31.8 mm</li> <li>• in M-Wave blister packaging</li> </ul>	   <b>0,5 WATT</b>  
<b>220628</b> 50/10 set	wie Art. 220627, Set für <b>vorne und hinten</b>	like art. 220627, set for <b>front and rear</b>	 
<b>220565</b> 100/10 set	<b>BATTERIEBLINKLICHT-SET</b> <b>›APOLLON MINI A‹</b> <ul style="list-style-type: none"> <li>• <b>hochwertiges Aluminiumgehäuse</b></li> <li>• Set mit <b>einer weißen und einer roten LED</b></li> <li>• <b>240° Abstrahlwinkel</b></li> <li>• 3 Funktionen (1x Dauer- und 2x Blinklicht)</li> <li>• nur <b>25 g/Stück</b></li> <li>• universelle, werkzeuglose Montage durch elastische Gummibänder Ø 22,2 - 31,8 mm</li> <li>• inkl. Batterien (je 2x CR 2032)</li> <li>• in M-Wave Blisterverpackung</li> </ul>	<b>BATTERY FLASHING LIGHT SET</b> <b>›APOLLON MINI A‹</b> <ul style="list-style-type: none"> <li>• <b>high quality aluminium</b> housing</li> <li>• set with <b>one white and one red LED</b></li> <li>• <b>240° radiation angle</b></li> <li>• 3 functions (1x steady and 2x flashing light)</li> <li>• only <b>25 g/piece</b></li> <li>• universal, toolless mounting with elastic rubber straps Ø 22.2 - 31.8 mm</li> <li>• incl. batteries (2x CR 2032 each)</li> <li>• in M-Wave blister packaging</li> </ul>	  <b>240°</b> 

Ohne deutsches Prüfzeichen - Verkauf und Nutzung im Geltungsbereich der StVZO (Deutschland) unzulässig (Abgabe nur an außerdeutsche Kunden).

UVP 3,90 €

Ohne deutsches Prüfzeichen - Verkauf und Nutzung im Geltungsbereich der StVZO (Deutschland) unzulässig (Abgabe nur an außerdeutsche Kunden).







UVP 19,90 €

Ohne deutsches Prüfzeichen - Verkauf und Nutzung im Geltungsbereich der StVZO (Deutschland) unzulässig (Abgabe nur an außerdeutsche Kunden).

UVP 8,90 €

ART.-NR. 	BESCHREIBUNG	DESCRIPTION	
<b>220608</b> 100/20 set	<b>BATTERIEBLINKLICHT-SET ›HUNTER‹</b> <ul style="list-style-type: none"> <li>• innovatives <b>Design</b></li> <li>• Set mit je <b>2 weißen</b> bzw. <b>2 roten LEDs</b></li> <li>• 3 Funktionen (1x Dauer- und 2x Blinklicht)</li> <li>• universelle Befestigung durch elastische Silikonbänder</li> <li>• werkzeuglose Montage</li> <li>• inkl. Batterien (je 2x CR 2032)</li> <li>• in M-Wave Blisterverpackung</li> </ul> <p>Ohne deutsches Prüfzeichen - Verkauf und Nutzung im Geltungsbereich der StVZO (Deutschland) unzulässig (Abgabe nur an außerdeutsche Kunden).</p>	<b>BATTERY FLASHING LIGHT SET ›HUNTER‹</b> <ul style="list-style-type: none"> <li>• innovative <b>design</b></li> <li>• set with <b>2 white</b> and <b>2 red LEDs</b></li> <li>• 3 functions (1x steady and 2x flashing light)</li> <li>• universal fixation with elastic silicone straps</li> <li>• toolless mounting</li> <li>• incl. batteries (each 2x CR 2032)</li> <li>• in M-Wave blister packaging</li> </ul> <p>UVP 7,90 €</p>	  
<b>220582</b> 100/50  <b>220583</b> 100	<b>BATTERIEBLINKLICHT ›COBRA‹</b> <ul style="list-style-type: none"> <li>• innovatives Design</li> <li>• 2 Funktionen (Dauer- und Blinklicht)</li> <li>• nur <b>18 g</b></li> <li>• universeller Gummihalter</li> <li>• <b>werkzeuglose</b> Schnellmontage</li> <li>• inkl. Schraubendreher für Batterie-wechsel</li> <li>• inkl. Batterien (2x CR 2025)</li> <li>• farbig sortiert</li> <li>• in M-Wave Blisterverpackung</li> </ul> <b>weiße LED</b>  <b>rote LED</b>	<b>BATTERY FLASHING LIGHT ›COBRA‹</b> <ul style="list-style-type: none"> <li>• innovative design</li> <li>• 2 functions (steady and flashing light)</li> <li>• only <b>18 g</b></li> <li>• universal rubber bracket</li> <li>• <b>toolless</b> quick mounting</li> <li>• incl. screw driver for changing batteries</li> <li>• incl. batteries (2x CR 2025)</li> <li>• assorted colours</li> <li>• in M-Wave blister packaging</li> </ul> <p>UVP 4,90 €</p>	<p><b>SILICONE</b></p>     <p>18 g</p>     
<b>220584</b> 100/50 set	<b>BATTERIEBLINKLICHT-SET ›COBRA‹</b> <ul style="list-style-type: none"> <li>• Set mit je einer <b>weißen</b> (Art. 220582) und <b>roten</b> (Art. 220583) <b>LED</b></li> <li>• farbig sortiert</li> <li>• in M-Wave Blisterverpackung</li> </ul> <p>Ohne deutsches Prüfzeichen - Verkauf und Nutzung im Geltungsbereich der StVZO (Deutschland) unzulässig (Abgabe nur an außerdeutsche Kunden).</p>	<b>BATTERY FLASHING LIGHT SET ›COBRA‹</b> <ul style="list-style-type: none"> <li>• set with one <b>white</b> (art. 220582) and one <b>red</b> (art. 220583) <b>LED</b></li> <li>• assorted colours</li> <li>• in M-Wave blister packaging</li> </ul> <p>UVP 7,90 €</p>	 
<b>220599</b> 100/50 set	<b>BATTERIEBLINKLICHT-SET ›COBRA II‹</b> <ul style="list-style-type: none"> <li>• Set mit je <b>2 weißen</b> bzw. <b>2 roten LEDs</b></li> <li>• 3 Funktionen (1x Dauer- und 2x Blinklicht)</li> <li>• nur 24 g</li> <li>• universelle Befestigung durch elastische Silikonbänder</li> <li>• werkzeuglose Montage</li> <li>• inkl. Batterien (je 2x CR 2032)</li> <li>• in M-Wave Blisterverpackung</li> </ul> <p>Ohne deutsches Prüfzeichen - Verkauf und Nutzung im Geltungsbereich der StVZO (Deutschland) unzulässig (Abgabe nur an außerdeutsche Kunden).</p>	<b>BATTERY FLASHING LIGHT SET ›COBRA II‹</b> <ul style="list-style-type: none"> <li>• set with <b>2 white</b> and <b>2 red LEDs</b></li> <li>• 3 functions (1x steady and 2x flashing light)</li> <li>• only 24 g</li> <li>• universal fixation with elastic silicone straps</li> <li>• toolless mounting</li> <li>• incl. batteries (each 2x CR 2032)</li> <li>• in M-Wave blister packaging</li> </ul> <p>UVP 6,90 €</p>	<p><b>SILICONE</b></p>     



ART.-NR.	BESCHREIBUNG	DESCRIPTION	
<b>221063</b> 100 set	<b>BATTERIEBLINKLICHT-SET ›COBRA III‹</b> <ul style="list-style-type: none"> <li>• Set mit je <b>2 weißen</b> bzw. <b>2 roten LEDs</b></li> <li>• 2 Funktionen (Dauer- und Blinklicht)</li> <li>• nur <b>19 g</b></li> <li>• universeller Gummihalter Ø 22,2 - 31,8 mm</li> <li>• werkzeuglose Montage</li> <li>• inkl. Batterien (je 2x CR 2032)</li> <li>• in M-Wave Blisterverpackung</li> </ul>	<b>BATTERY FLASHING LIGHT SET ›COBRA III‹</b> <ul style="list-style-type: none"> <li>• set with <b>2 white</b> and <b>2 red LEDs</b></li> <li>• 2 functions (steady and flashing light)</li> <li>• only <b>19 g</b></li> <li>• universal rubber bracket Ø 22.2 - 31.8 mm</li> <li>• toolless mounting</li> <li>• incl. batteries (each 2x CR 2032)</li> <li>• in M-Wave blister packaging</li> </ul>	  
<b>NICE PRICE</b>	<b>BATTERIEBLINKLICHT-SET ›COBRA IV‹</b> <ul style="list-style-type: none"> <li>• Set mit je <b>2 weißen</b> und <b>2 roten LEDs</b></li> <li>• 3 Funktionen (1x Dauer- und 2x Blinklicht)</li> <li>• nur 24 g pro Licht</li> <li>• universeller Silikonhalter</li> <li>• werkzeuglose Montage</li> <li>• inkl. Batterien (je 2x CR 2032)</li> <li>• in M-Wave Blisterverpackung</li> </ul>	<b>BATTERY FLASHING LIGHT SET ›COBRA IV‹</b> <ul style="list-style-type: none"> <li>• set with <b>2 white</b> and <b>2 red LEDs</b></li> <li>• 3 functions (1x steady and 2x flashing light)</li> <li>• only 24 g per lamp</li> <li>• universal silicone bracket</li> <li>• toolless mounting</li> <li>• incl. batteries (each 2x CR 2032)</li> <li>• in M-Wave blister packaging</li> </ul>	<b>SILICONE</b>    
<b>220640</b>	schwarz	black	
<b>220632</b>	weiß	white	
<b>220633</b>	rot	red	
<b>220634</b>	blau	blue	
<b>220635</b>	grün	green	
<b>220636</b>	gelb	yellow	
<b>220637</b>	orange	orange	
<b>220638</b>	pink	pink	
<b>220639</b> 100/20 set	lila	purple	
	Ohne deutsches Prüfzeichen - Verkauf und Nutzung im Geltungsbereich der StVZO (Deutschland) unzulässig (Abgabe nur an außerdeutsche Kunden).	UVP 6,90 €	

ART.-NR. 	BESCHREIBUNG	DESCRIPTION	
<b>221058</b> 40/10 set	<b>AKKULAMPEN-SET ›ATLAS K10 USB‹</b> <ul style="list-style-type: none"> <li>mit <b>deutschem Prüfzeichen</b></li> <li><b>wasserfestes Silikongehäuse</b></li> <li>integrierter <b>universeller Silikonhalter</b></li> <li><b>schnelle</b> werkzeuglose Montage</li> <li>mit Batterie- und Ladezustandsanzeige</li> <li>aufladbar über <b>USB-Kabel</b> (inkl.)</li> <li>in M-Wave Eurolochkarte</li> </ul> <p><b>Frontlicht</b> (Art. 220405):</p> <ul style="list-style-type: none"> <li>1 weiße <b>CREE LED</b></li> <li>Helligkeit <b>25 Lux</b></li> <li>nur ca. 86 g</li> <li>Lithium-Polymer Schnellladeakku</li> <li>Halter für Ø 22,2 - 32 mm</li> </ul> <p><b>Rücklicht</b> (Art. 220572):</p> <ul style="list-style-type: none"> <li>1 rote <b>Hochleistungs-LED</b></li> <li><b>Lithium-Akku</b></li> </ul>	<b>RECHARGEABLE LAMP SET ›ATLAS K10 USB‹</b> <ul style="list-style-type: none"> <li>with <b>German approval number</b></li> <li><b>water resistant silicone housing</b></li> <li>integrated <b>universal silicone bracket</b></li> <li><b>quick</b> toolless mounting</li> <li>with battery level and charge control indicator</li> <li>rechargeable by <b>USB cable</b> (incl.)</li> <li>in M-Wave eurohole card</li> </ul> <p><b>front light</b> (art. 220405):</p> <ul style="list-style-type: none"> <li>1 white <b>CREE LED</b></li> <li>brightness <b>25 Lux</b></li> <li>only approx. 86 g</li> <li>Lithium Polymer quick charge battery</li> <li>bracket for Ø 22.2 - 32 mm</li> </ul> <p><b>rear light</b> (art. 220572):</p> <ul style="list-style-type: none"> <li>1 red <b>high power LED</b></li> <li><b>Lithium rechargeable battery</b></li> </ul> <p>UVP 49,90 €</p>	 <p><b>CREE</b> Genuine Cree XHP Power LED</p> <p><b>SILICONE</b></p> <p><b>25 LUX</b></p> <p><b>german approval</b></p>
<b>221090</b> 50/10 set	<b>AKKULAMPEN-SET ›ATLAS K 11 USB‹</b> <ul style="list-style-type: none"> <li>mit <b>deutschem Prüfzeichen</b></li> <li>schnelle werkzeuglose Montage</li> <li>mit <b>Batterie- und Ladezustandsanzeige</b></li> <li>aufladbar über <b>USB-Kabel</b> (inkl.)</li> <li><b>Lithium-Akku</b></li> <li>in M-Wave Blisterverpackung</li> </ul> <p><b>Frontlicht:</b></p> <ul style="list-style-type: none"> <li>1 weiße <b>Osram LED</b></li> <li><b>2 Funktionen</b> (2x Dauerlicht)</li> <li>Helligkeit <b>28 / 15 Lux</b></li> <li>bis zu <b>70 Lumen</b></li> <li>Halter für Ø 22,2 - 31,8 mm (Art. 223553)</li> <li>nur ca. <b>55 g</b></li> </ul> <p><b>Rücklicht:</b></p> <ul style="list-style-type: none"> <li>3 rote <b>LEDs</b></li> <li>nur ca. <b>23 g</b></li> <li>Halter für Ø 25,4 - 33 mm (Art. 223554)</li> </ul>	<b>RECHARGEABLE LAMP SET ›ATLAS K 11 USB‹</b> <ul style="list-style-type: none"> <li>with <b>German approval number</b></li> <li>quick toolless mounting</li> <li>with <b>battery level and charge control indicator</b></li> <li>rechargeable by <b>USB cable</b> (incl.)</li> <li><b>rechargeable Lithium battery</b></li> <li>in M-Wave blister packaging</li> </ul> <p><b>front light:</b></p> <ul style="list-style-type: none"> <li>1 white <b>Osram LED</b></li> <li><b>2 functions</b> (2x steady light)</li> <li>brightness <b>28 / 15 Lux</b></li> <li>up to <b>70 Lumen</b></li> <li>bracket for Ø 22.2 - 31.8 mm (art. 223553)</li> <li>only approx. <b>55 g</b></li> </ul> <p><b>rear light:</b></p> <ul style="list-style-type: none"> <li>3 red <b>LEDs</b></li> <li>only approx. <b>23 g</b></li> <li>bracket for Ø 25.4 - 33 mm (art. 223554)</li> </ul> <p>UVP 19,90 €</p>	 <p><b>28 / 15 LUX</b></p> <p><b>german approval</b></p>
<b>221091</b> 40/10 set <b>NICE PRICE</b>	<b>AKKULAMPEN-SET ›ATLAS K 15 USB‹</b> <ul style="list-style-type: none"> <li>mit <b>deutschem Prüfzeichen</b></li> <li>schnelle werkzeuglose Montage</li> <li>mit Batterie- und Ladezustandsanzeige</li> <li>aufladbar über <b>USB-Kabel</b> (inkl.)</li> <li>in M-Wave Blisterverpackung</li> </ul> <p><b>Frontlicht</b> Art. 220404:</p> <ul style="list-style-type: none"> <li>1 weiße <b>LED</b></li> <li>2 Funktionen (maximale Beleuchtung, Energiesparmodus)</li> <li>Helligkeit <b>30 / 15 Lux</b></li> <li>360° drehbarer Halter für Ø 19 - 31,8 mm (Art. 223559)</li> <li>nur ca. 51 g</li> <li><b>Lithium-Akku</b> (3,7 V / 1.200 mAh)</li> </ul> <p><b>Rücklicht</b> Art. 220559:</p> <ul style="list-style-type: none"> <li>1 rote <b>LED</b></li> <li>Halter für Ø 19 - 31,8 mm (Art. 223561)</li> <li><b>240 Grad</b> Abstrahlwinkel</li> <li><b>Lithium-Polymer Akku</b></li> </ul>	<b>RECHARGEABLE LAMP SET ›ATLAS K 15 USB‹</b> <ul style="list-style-type: none"> <li>with <b>German approval number</b></li> <li>quick toolless mounting</li> <li>with battery level and charge control indicator</li> <li>rechargeable by <b>USB cable</b> (incl.)</li> <li>in M-Wave blister packaging</li> </ul> <p><b>front light</b> art. 220404:</p> <ul style="list-style-type: none"> <li>1 white <b>LED</b></li> <li>2 functions (maximum illumination, power saving mode)</li> <li>brightness <b>30 / 15 Lux</b></li> <li>360° turnable bracket for Ø 19 - 31.8 mm (Art. 223559)</li> <li>only approx. 51 g</li> <li><b>rechargeable Lithium battery</b> (3.7 V / 1,200 mAh)</li> </ul> <p><b>rear light</b> art. 220559:</p> <ul style="list-style-type: none"> <li>1 red <b>LED</b></li> <li>bracket for Ø 19 - 31.8 mm (Art. 223561)</li> <li><b>240 degrees</b> illumination angle</li> <li><b>rechargeable Lithium Polymer battery</b></li> </ul> <p>UVP 29,90 €</p>	 <p><b>30 / 15 LUX</b></p> <p><b>german approval</b></p>

ART.-NR.	BESCHREIBUNG	DESCRIPTION	
<b>221092</b> 50/10 set	<b>AKKULAMPEN-SET &gt;ATLAS 20 USB&lt;</b> <ul style="list-style-type: none"> <li>mit Batterie- und Ladezustandsanzeige</li> <li>aufladbar über <b>USB-Kabel</b> (inkl.)</li> <li>Lithium-Akku</li> <li>auf M-Wave Eurolochkarte</li> </ul> <p><b>Frontlicht</b> Art. 220421:</p> <ul style="list-style-type: none"> <li>1 weiße <b>1 Watt</b> LED mit SST (<b>Soft Start Technology</b>)</li> <li>hochwertiges <b>Aluminiumgehäuse</b></li> <li><b>3 Funktionen:</b> 2x Dauer- und 1x Blinklicht</li> <li>Helligkeit bis zu 20 Lux, 95 Lumen</li> <li>Halter für Ø 22,2 - 35 mm (Art. 223551)</li> <li>nur ca. <b>54 g</b></li> </ul> <p><b>Rücklicht:</b></p> <ul style="list-style-type: none"> <li>1x <b>0,5 Watt</b> LED mit rotem Glas</li> <li>3 Funktionen: 2x Dauer- und 1x Blinklicht</li> <li>schnelle werkzeuglose Montage</li> <li>winkelverstellbarer Halter für Ø 25,4 - 35 mm</li> <li>nur ca. <b>17 g</b></li> </ul> <p><small>Ohne deutsches Prüfzeichen - Verkauf und Nutzung im Geltungsbereich der StVZO (Deutschland) unzulässig (Abgabe nur an außerdeutsche Kunden).</small></p>	<b>RECHARGEABLE LAMP SET &gt;ATLAS 20 USB&lt;</b> <ul style="list-style-type: none"> <li>with battery level and charge control indicator</li> <li>rechargeable by <b>USB cable</b> (incl.)</li> <li>rechargeable Lithium battery</li> <li>on M-Wave eurohole card</li> </ul> <p><b>front light</b> art. 220421:</p> <ul style="list-style-type: none"> <li>1 white <b>1 Watt</b> LED with SST (<b>Soft Start Technology</b>)</li> <li>high quality <b>aluminium</b> housing</li> <li><b>3 functions:</b> 2x steady and 1x flashing light</li> <li>brightness levels up to 20 Lux, 95 Lumen</li> <li>bracket for Ø 22.2 - 35 mm (art. 223551)</li> <li>only approx. <b>54 g</b></li> </ul> <p><b>rear light:</b></p> <ul style="list-style-type: none"> <li>1x <b>0.5 Watt</b> LED with red glas</li> <li>3 functions: 2x steady and 1x flashing light</li> <li>quick toolless mounting</li> <li>angle-adjustable bracket for Ø 25.4 - 35 mm</li> <li>only approx. <b>17 g</b></li> </ul> <p><small>Ohne deutsches Prüfzeichen - Verkauf und Nutzung im Geltungsbereich der StVZO (Deutschland) unzulässig (Abgabe nur an außerdeutsche Kunden).</small></p>	   <p><b>1 WATT</b></p>  <p><b>0,5 WATT</b></p>  
<b>221064</b> 40/10 set	<b>BATTERIELEUCHTEN-SET &gt;ATLAS 22&lt;</b> <ul style="list-style-type: none"> <li>inkl. Batterien (6x AAA)</li> <li>in M-Wave Eurolochkarte</li> </ul> <p><b>Frontlicht</b> (Art. 220887):</p> <ul style="list-style-type: none"> <li><b>Aluminiumgehäuse</b></li> <li>weiße, <b>ultrahelle 3 Watt LED</b></li> <li>2 Funktionen: Dauer- und Blinklicht</li> <li>mit Dreh-Clip-on-Halter für Ø 22,2 - 31,8 mm (Art. 223541), werkzeuglose Montage</li> </ul> <p><b>Blinklicht</b> (Art. 221040):</p> <ul style="list-style-type: none"> <li>3 rote LEDs</li> <li>3 Funktionen: 1x Dauer- und 2x Blinklicht</li> <li>mit Halter (Art. 220824) für Sattelstütze und Gürtelclip</li> </ul> <p><small>Ohne deutsches Prüfzeichen - Verkauf und Nutzung im Geltungsbereich der StVZO (Deutschland) unzulässig (Abgabe nur an außerdeutsche Kunden).</small></p>	<b>BATTERY LAMP SET &gt;ATLAS 22&lt;</b> <ul style="list-style-type: none"> <li>incl. batteries (6x AAA)</li> <li>in M-Wave eurohole card</li> </ul> <p><b>front light</b> (art. 220887):</p> <ul style="list-style-type: none"> <li><b>aluminium</b> housing</li> <li>white, <b>ultra bright 3 Watt LED</b></li> <li>2 functions: steady and flashing light</li> <li>with twist clip-on bracket for Ø 22.2 - 31.8 mm (art. 223541), toolless mounting</li> </ul> <p><b>flashing light</b> (art. 221040):</p> <ul style="list-style-type: none"> <li>3 red LEDs</li> <li>3 functions: 1x steady and 2x flashing light</li> <li>with bracket (art. 220824) for seat post and belt clip</li> </ul> <p><small>Ohne deutsches Prüfzeichen - Verkauf und Nutzung im Geltungsbereich der StVZO (Deutschland) unzulässig (Abgabe nur an außerdeutsche Kunden).</small></p>	  <p><b>3 WATT</b></p>  





**160 kg  
MAX**



TREKKING/GRAVEL  
160 kg



[www.messingschlagler.com/en/partfinder](http://www.messingschlagler.com/en/partfinder)



ART.-NR. 	BESCHREIBUNG	DESCRIPTION	
<b>221057</b> 40/10 set	<b>BATTERIELEUCHTEN-SET ›ATLAS K50‹</b> <ul style="list-style-type: none"> <li>mit <b>deutschem Prüfzeichen</b></li> <li>mit Batteriezustandsanzeige</li> <li>inkl. Batterien (4x AAA / 2x AAA)</li> <li>in M-Wave Blisterverpackung</li> </ul> <p><b>Frontlicht</b> (Art. 220447):</p> <ul style="list-style-type: none"> <li>1 weiße <b>Hochleistungs-LED</b></li> <li><b>Klarglasscheinwerfer</b> mit <b>Freiform-reflektor</b></li> <li>2 Helligkeitsstufen: <b>30/15 Lux</b></li> <li>nur <b>49 g</b> (ohne Batterien)</li> <li>mit QR-Clip-on-Halter für <b>Ø 22,2 - 31,8 mm</b> (Art. 223515), werkzeuglose Montage</li> </ul> <p><b>Rücklicht</b> (Art. 220569):</p> <ul style="list-style-type: none"> <li>1 rote <b>Hochleistungs-SMD-LED</b></li> <li>Universalhalter passend für <b>Ø 25,4 - 31,8 mm</b> (Art. 223516)</li> </ul>	<b>BATTERY LAMP SET ›ATLAS K50‹</b> <ul style="list-style-type: none"> <li>with <b>German approval number</b></li> <li>with battery level indicator</li> <li>incl. batteries (4x AAA / 2x AAA)</li> <li>in M-Wave blister packaging</li> </ul> <p><b>front light</b> (art. 220447):</p> <ul style="list-style-type: none"> <li>1 white <b>high power/performance LED</b></li> <li><b>clear lense beam with special reflector</b></li> <li>2 brightness levels: <b>30/15 Lux</b></li> <li>only <b>49 g</b> (w/o batteries)</li> <li>with QR clip-on bracket for <b>Ø 22.2 - 31.8 mm</b> (art. 223515), toolless mounting</li> </ul> <p><b>rear light</b> (art. 220569):</p> <ul style="list-style-type: none"> <li>1 red <b>high power SMD LED</b></li> <li>universal bracket for <b>Ø 25.4 - 31.8 mm</b> (art. 223516)</li> </ul> <p style="text-align: right;">UVP 16,90 €</p>	  <p><b>30 / 15 LUX</b></p> 
<b>220423</b> 144/72	<b>STIRNLAMPE ›HELIOS RUNNER 140‹</b> <ul style="list-style-type: none"> <li><b>Cree XP-G2 R5 LED, 5 Watt</b></li> <li>leichtes, wasserdichtes (IPX5) Kunststoffgehäuse</li> <li>4 Funktionen: 3x Helligkeitsstufen und zusätzliche <b>SOS-Funktion</b></li> <li><b>Sensorfunktion:</b> an/aus über Handbewegung zu steuern</li> <li>justierbarer und flexibler Kopfgurt mit <b>Anti-Rutsch-Silikon-Beschichtung</b></li> <li>Helligkeit bis zu 140 Lumen</li> <li>Abstrahlwinkel bis zu 60° einstellbar</li> <li>Lithium-Polymer Akku, 1.200 mAh</li> <li>Laufzeit: bis zu 15 Stunden</li> <li>inkl. Micro <b>USB</b>-Kabel</li> <li>mit Batterie- und Ladezustandsanzeige</li> <li>nur 52 g (ohne Kopfgurt)</li> <li>in M-Wave Eurolochbox</li> </ul> <p>Ohne deutsches Prüfzeichen - Verkauf und Nutzung im Geltungsbereich der StVZO (Deutschland) unzulässig (Abgabe nur an außerdeutsche Kunden).</p>	<b>HEAD LIGHT ›HELIOS RUNNER 140‹</b> <ul style="list-style-type: none"> <li><b>Cree XP-G2 R5 LED, 5 Watt</b></li> <li>light and waterproof (IPX5) plastic housing</li> <li>4 functions: 3x brightness levels and additional <b>SOS function</b></li> <li><b>sensor function:</b> control on/off by hand movement</li> <li>adjustable and flexible head belt with <b>non-slip silicone coating</b></li> <li>brightness up to 140 Lumen</li> <li>adjustable beam angle up to 60°</li> <li>rechargeable lithium polymer battery, 1,200 mAh</li> <li>running time: up to 15 hours</li> <li>incl. Micro <b>USB</b> cable</li> <li>with battery level and charge control indicator</li> <li>only 52 g (without head strap)</li> <li>in M-Wave eurohole box</li> </ul> <p style="text-align: right;">UVP 18,90 €</p>	     <p><b>52 g</b></p> <p><b>SENSOR FUNCTION</b></p>  <p><b>ON / OFF</b></p> <p><b>5 WATT</b></p>
<b>223570</b> 100	<b>KONVERTER ›POWER BASE‹</b> <ul style="list-style-type: none"> <li>von Wechselstrom- auf <b>USB</b>-Anschluss</li> <li><b>Eingangsleistung:</b> 100-240 V Wechselstrom, 0,15 A, 50/60 Hz</li> <li><b>Ausgangsleistung:</b> 5 V Gleichstrom, max. 1 A</li> <li>Schutzklasse II, IP 20</li> <li>mit <b>Lade-Kontrolleuchte</b></li> <li>auf M-Wave Eurolochkarte</li> </ul>	<b>CONVERTER ›POWER BASE‹</b> <ul style="list-style-type: none"> <li>AC to <b>USB</b></li> <li><b>Input:</b> AC 100-240 V, 0.15 A, 50/60 Hz</li> <li><b>Output:</b> DC 5 V, max. 1 A</li> <li>protection class II, IP 20</li> <li>with <b>battery indicator light</b></li> <li>on M-Wave eurohole card</li> </ul> <p style="text-align: right;">UVP 5,90 €</p>	  

ART.-NR. 	BESCHREIBUNG	DESCRIPTION	
<b>220753</b> 120/20	<b>LENKERCOCKPIT ›COCKPIT PLUS‹</b> <ul style="list-style-type: none"> <li>• passend für Lenker mit <b>Ø 22,2 - 31,8 mm</b></li> <li>• Rohrdurchmesser 22,2 mm</li> <li>• Breite 90 mm</li> <li>• <b>verschiebbar</b></li> <li>• auf M-Wave Eurolochkarte</li> </ul>	<b>HANDLEBAR ORGANIZER ›COCKPIT PLUS‹</b> <ul style="list-style-type: none"> <li>• for handlebar with <b>Ø 22.2 - 31.8 mm</b></li> <li>• tube diameter 22.2 mm</li> <li>• width 90 mm</li> <li>• <b>slidable</b></li> <li>• on M-Wave eurohole card</li> </ul>	 <p>UVP 9,90 €</p> 
<b>220972</b> 200/50	<b>GABELHALTER ›FORK COCKPIT‹</b> <ul style="list-style-type: none"> <li>• passend für <b>Gabelbrücke</b> und <b>Gabelkopf</b></li> <li>• runde Aufnahme mit Ø 22,2 mm</li> <li>• <b>ausziehbar</b></li> <li>• universell geeignet für fast alle Batterielampen, Computer, ...</li> <li>• auf M-Wave Eurolochkarte</li> </ul>	<b>FORK BRACKET ›FORK COCKPIT‹</b> <ul style="list-style-type: none"> <li>• suitable for <b>fork arch</b> and <b>crown</b></li> <li>• round fixing point with Ø 22.2 mm</li> <li>• <b>extendable</b></li> <li>• universally suitable for almost all battery lamps, computers, ...</li> <li>• on M-Wave eurohole card</li> </ul>	 <p>UVP 4,90 €</p> 
<b>223560</b> 200/20	<b>SCHNELLSPANNER- LAMPENHALTER ›AXLE MOUNT‹</b> <ul style="list-style-type: none"> <li>• zur Befestigung <b>am Schnellspanner</b> (5 mm, nicht inklusive)</li> <li>• <b>CNC-gefrästes Aluminium</b></li> <li>• Länge: 57 mm, Ø 26 mm</li> <li>• Gewicht: 19 g</li> <li>• auf M-Wave Eurolochkarte</li> </ul>	<b>QUICK RELEASE LAMP HOLDER ›AXLE MOUNT‹</b> <ul style="list-style-type: none"> <li>• for mounting <b>at QR</b> (5 mm, not included)</li> <li>• <b>CNC machined aluminium</b></li> <li>• length: 57 mm, Ø 26 mm</li> <li>• weight: 19 g</li> <li>• on M-Wave eurohole card</li> </ul>	   <p>UVP 8,90 €</p> 
<b>223523</b> 200	<b>UNIVERSALHALTER</b> <ul style="list-style-type: none"> <li>• passend z. B. für <b>iPod, Mobiltelefone, Lampen, Luftpumpen, Schlösser, Powerbanks, ...</b></li> <li>• <b>360°</b> drehbar</li> <li>• <b>werkzeuglose Schnellmontage</b></li> <li>• Ersatzgummi oben Art. 223517</li> <li>• Ersatzgummi unten Art. 223518</li> </ul>	<b>UNIVERSAL BRACKET</b> <ul style="list-style-type: none"> <li>• suitable e.g. for <b>iPod, mobile phones, lamps, pumps, locks, powerbanks, ...</b></li> <li>• <b>360°</b> turnable</li> <li>• <b>toolless quick mounting</b></li> <li>• replacement rubber top art. 223517</li> <li>• replacement rubber down art. 223518</li> </ul>	 <p>Art. 223517 →</p> <p>Art. 223518 →</p>  <p>UVP 1,50 €</p>









ART.-NR.	BESCHREIBUNG	DESCRIPTION	
<p><b>221030</b></p> <p>40/10</p>	<p><b>AKKURÜCK- UND ABBIEGELICHT</b></p> <p>mit <b>Blinkern</b> zur <b>Fahrtrichtungsanzeige</b> und <b>Rücklicht</b></p> <ul style="list-style-type: none"> <li>• Abbiegelicht: <b>12 gelbe LEDs / Seite</b></li> <li>• Rücklicht: <b>5 rote LEDs</b>, mit 2 Funktionen (Dauer- und Blinklicht)</li> <li>• Lithium-Polymer Akku (3,7 V / 800 mAh)</li> <li>• aufladbar über <b>USB-Kabel</b> (inkl.)</li> <li>• mit Batterie- und Ladezustandsanzeige</li> <li>• universeller Gummihalter Ø 19 - 31,8 mm, 90° drehbar und in der Neigung verstellbar</li> <li>• werkzeuglose Montage an der Sattelstütze oder an Sitzrohrstreben</li> </ul> <p><b>Funk-Lenker-Fernbedienung</b> für Blinker und Rücklicht</p> <ul style="list-style-type: none"> <li>• mit <b>Funktionsanzeige</b></li> <li>• werkzeuglose Montage</li> <li>• für Lenker Ø 22,2 - 25,4 mm</li> <li>• inkl. Batterie (CR 2032)</li> </ul> <ul style="list-style-type: none"> <li>• in Ventura Blisterverpackung</li> </ul>	<p><b>RECHARGEABLE REAR AND TURNING LIGHT</b></p> <p>with <b>turn signals</b> for <b>direction indication</b> and <b>rear light</b></p> <ul style="list-style-type: none"> <li>• turning light: <b>12 yellow LEDs / side</b></li> <li>• rear light: <b>5 red LEDs</b>, with 2 functions (steady and flashing light)</li> <li>• rechargeable Lithium Polymer battery (3.7 V / 800 mAh)</li> <li>• rechargeable by <b>USB cable</b> (incl.)</li> <li>• with battery level and charge control indicator</li> <li>• universal rubber bracket Ø 19-31.8 mm, turnable by 90° and adjustable inclination</li> <li>• toolless mounting at the seat post or seat stays</li> </ul> <p><b>wireless handlebar controller</b> for turn signals and rear light</p> <ul style="list-style-type: none"> <li>• with <b>function display</b></li> <li>• toolless mounting</li> <li>• for handlebar Ø 22.2 - 25.4 mm</li> <li>• incl. battery (CR 2032)</li> </ul> <ul style="list-style-type: none"> <li>• in Ventura blister packaging</li> </ul>	    <p><b>TURN</b></p>  <p><b>REAR</b></p>  
<p>Ohne deutsches Prüfzeichen - Verkauf und Nutzung im Geltungsbereich der StVZO (Deutschland) unzulässig (Abgabe nur an außerdeutsche Kunden).</p>		<p>UVP 19,90 €</p>	



ART.-NR. 	BESCHREIBUNG	DESCRIPTION	 <b>E-BIKE BATTERY → GLEICHSTROM/DC</b>
<b>461652</b> 48/12	<b>E-BIKE SCHEINWERFER ›ELITE 100‹</b> <ul style="list-style-type: none"> <li>• <b>350 Lumen</b></li> <li>• 6 - 15 V DC/4,8 W</li> <li>• <b>100 Lux</b></li> <li>• Leuchtmittel: <b>Osram LED</b></li> <li>• hochwertiges <b>Aluminium-Gehäuse</b></li> <li>• mit <b>deutschem Prüfzeichen</b></li> <li>• mit Doppelkabel, 120 cm</li> <li>• mit verstellbarem Halter</li> <li>• mit <b>abnehmbarem Reflektor</b></li> <li>• mit Adapter zur Montage ohne Reflektor</li> <li>• in Smart Eurolochbox</li> </ul>	<b>E-BIKE HEAD LAMP ›ELITE 100‹</b> <ul style="list-style-type: none"> <li>• <b>350 lumen</b></li> <li>• 6 - 15 V DC/4.8 W</li> <li>• <b>100 Lux</b></li> <li>• illuminant: <b>Osram LED</b></li> <li>• high-quality <b>aluminium</b> housing</li> <li>• with <b>German approval number</b></li> <li>• with double cable, 120 cm</li> <li>• with adjustable bracket</li> <li>• with <b>removable reflector</b></li> <li>• with adapter for mounting without reflector</li> <li>• in Smart eurohole box</li> </ul> <p style="text-align: right;">UVP 37,90 €</p>	<div style="display: flex; justify-content: space-between;"> <span><b>350 LUMEN</b></span> <span><b>SMART®</b></span> </div>  <p style="text-align: right;"><b>100 LUX</b></p>
<b>461651</b> 50/10	<b>E-BIKE-SCHEINWERFER ›D&amp;E‹</b> <ul style="list-style-type: none"> <li>• 6 - 48 V DC/2,1 W</li> <li>• mit <b>Reflektor</b></li> <li>• 1 weiße <b>LED</b></li> <li>• <b>30 Lux</b></li> <li>• mit <b>deutschem Prüfzeichen</b></li> <li>• mit verstellbarem Halter</li> <li>• 2 im Gehäuse integrierte Flachsteckanschlüsse</li> <li>• auf Smart Eurolochkarte</li> </ul>	<b>E-BIKE HEAD LAMP ›D&amp;E‹</b> <ul style="list-style-type: none"> <li>• 6 - 48 V DC/2.1 W</li> <li>• <b>with reflector</b></li> <li>• 1 white <b>LED</b></li> <li>• <b>30 Lux</b></li> <li>• with <b>German approval number</b></li> <li>• with adjustable bracket</li> <li>• 2 flat plugs integrated in the housing</li> <li>• on Smart eurohole card</li> </ul> <p style="text-align: right;">UVP 16,90 €</p>	<div style="display: flex; justify-content: space-between;"> <span></span> <span><b>SMART®</b></span> </div> 
<b>466142</b> 50/10	<b>E-BIKE-SCHEINWERFER ›APOLLON E 100‹</b> <ul style="list-style-type: none"> <li>• <b>100 Lux</b></li> <li>• 6 - 48 V DC/1,4 W</li> <li>• hochwertiges <b>Aluminium-/Kunststoffgehäuse</b></li> <li>• mit <b>deutschem Prüfzeichen</b></li> <li>• <b>abnehmbarer Reflektor</b></li> <li>• mit <b>2-fach verstellbarem Halter</b></li> <li>• mit Doppelkabel, 10 cm, mit Flachstecker</li> <li>• auf M-Wave Eurolochkarte</li> </ul>	<b>E-BIKE HEAD LAMP ›APOLLON E 100‹</b> <ul style="list-style-type: none"> <li>• <b>100 Lux</b></li> <li>• 6 - 48 V DC/1.4 W</li> <li>• high quality <b>aluminium/plastic</b> housing</li> <li>• with <b>German approval number</b></li> <li>• <b>removable reflector</b></li> <li>• with <b>double adjustable bracket</b></li> <li>• with double cable, 10 cm, with flat plug</li> <li>• on M-Wave eurohole card</li> </ul> <p style="text-align: right;">UVP 34,90 €</p>	<div style="display: flex; justify-content: space-between;"> <span></span> <span><b>M-WAVE</b></span> </div>  <p style="text-align: right;"><b>100 LUX</b></p>
<b>466141</b> 50/10	<b>E-BIKE-SCHEINWERFER ›APOLLON E 80‹</b> <ul style="list-style-type: none"> <li>• <b>80 Lux</b></li> <li>• 6 - 48 V DC/2,4 W</li> <li>• mit <b>deutschem Prüfzeichen</b></li> <li>• <b>abnehmbarer Reflektor</b></li> <li>• mit <b>2-fach verstellbarem Halter</b></li> <li>• mit Doppelkabel, 10 cm, mit Flachstecker</li> <li>• auf M-Wave Eurolochkarte</li> </ul>	<b>E-BIKE HEAD LAMP ›APOLLON E 80‹</b> <ul style="list-style-type: none"> <li>• <b>80 Lux</b></li> <li>• 6 - 48 V DC/2.4 W</li> <li>• with <b>German approval number</b></li> <li>• <b>removable reflector</b></li> <li>• with <b>double adjustable bracket</b></li> <li>• with double cable, 10 cm, with flat plug</li> <li>• on M-Wave eurohole card</li> </ul> <p style="text-align: right;">UVP 21,90 €</p>	<div style="display: flex; justify-content: space-between;"> <span></span> <span><b>M-WAVE</b></span> </div>  <p style="text-align: right;"><b>80 LUX</b></p>













ART.-NR.	BESCHREIBUNG	DESCRIPTION	 <b>E-BIKE BATTERY</b> → GLEICHSTROM/DC
<b>466143</b> 100	<b>E-BIKE-SCHEINWERFER</b> <b>›APOLLON E 30‹</b> <ul style="list-style-type: none"> <li>• <b>30 Lux</b></li> <li>• 6 - 48 V DC/1,3 W</li> <li>• mit <b>deutschem Prüfzeichen</b></li> <li>• Reflektor mit deutschem Prüfzeichen</li> <li>• mit Edelstahlhalter</li> <li>• mit Doppelkabel, 10 cm, mit Flachstecker</li> <li>• Montageverpackung</li> </ul>	<b>E-BIKE HEAD LAMP</b> <b>›APOLLON E 30‹</b> <ul style="list-style-type: none"> <li>• <b>30 Lux</b></li> <li>• 6 - 48 V DC/1.3 W</li> <li>• with <b>German approval number</b></li> <li>• reflector with German approval number</li> <li>• with stainless steel bracket</li> <li>• with double cable, 10 cm, with flat plug</li> <li>• OEM</li> </ul>	 <p>30 LUX</p> <p>STAINLESS</p> <p>UVP 11,90 €</p>

UNSERE LITEMOVE-SCHEINWERFER FINDEN SIE AB SEITE 646. | YOU WILL FIND OUR LITEMOVE HEADLIGHTS AT PAGE 646.

DYNAMO		DYNAMO	
<b>461606</b> Montageverpackung	<b>LED-DYNAMOSCHEINWERFER</b> <b>›APOLLON D 50‹</b> <ul style="list-style-type: none"> <li>• <b>50 Lux</b></li> <li>• 6 V/2,2 W</li> <li>• mit <b>Ein-/Ausschalter</b></li> <li>• mit <b>Standlichtfunktion</b></li> <li>• mit <b>deutschem Prüfzeichen</b></li> <li>• <b>abnehmbarer</b> Reflektor</li> <li>• mit Edelstahlhalter</li> <li>• mit Doppelkabel</li> </ul>	<b>LED DYNAMO HEAD LAMP</b> <b>›APOLLON D 50‹</b> <ul style="list-style-type: none"> <li>• <b>50 Lux</b></li> <li>• 6 V/2.2 W</li> <li>• with <b>on/off switch</b></li> <li>• with <b>standlight function</b></li> <li>• with <b>German approval number</b></li> <li>• <b>removable</b> reflector</li> <li>• with stainless steel bracket</li> <li>• with double cable</li> </ul>	<p>STANDLIGHT</p>  <p>50 LUX</p> <p>ON/OFF</p> <p>STAINLESS</p> <p>UVP 13,90 €</p>
<b>461607</b> auf M-Wave Eurolochkarte 50/10	auf M-Wave Eurolochkarte	on M-Wave eurohole card	

<ul style="list-style-type: none"> <li>• <b>466944</b>                100</li> <li>• <b>466945</b>                100/20</li> </ul>	<b>LED-DYNAMOSCHEINWERFER</b> <b>›APOLLON D 30‹</b> <ul style="list-style-type: none"> <li>• <b>30 Lux</b></li> <li>• 6 V/2,4 W</li> <li>• mit <b>Ein-/Ausschalter</b> (für Vorder- und Rücklicht)</li> <li>• mit <b>Standlichtfunktion</b></li> <li>• mit <b>deutschem Prüfzeichen</b></li> <li>• <b>abnehmbarer</b> Reflektor</li> <li>• mit Edelstahlhalter</li> <li>• mit 2 Doppelkabeln, 100 cm</li> <li>• 2 im Gehäuse integrierte Flachsteckanschlüsse</li> </ul>	<b>LED DYNAMO HEAD LAMP</b> <b>›APOLLON D 30‹</b> <ul style="list-style-type: none"> <li>• <b>30 Lux</b></li> <li>• 6 V/2.4 W</li> <li>• with <b>on/off switch</b> (for front and rear light)</li> <li>• with <b>standlight function</b></li> <li>• with <b>German approval number</b></li> <li>• <b>removable</b> reflector</li> <li>• with stainless steel bracket</li> <li>• with 2 double cables, 100 cm</li> <li>• 2 flat plugs integrated in the housing</li> </ul>	<p>STANDLIGHT</p>  <p>30 LUX</p> <p>ON/OFF</p> <p>STAINLESS</p> <p>UVP 12,90 €</p>
---	---	--	--



ART.-NR. 	BESCHREIBUNG	DESCRIPTION	
<b>461688</b> 50/10	<b>LED-DYNAMOSCHEINWERFER</b> <ul style="list-style-type: none"> <li>weiße, <b>superhelle LED</b></li> <li>Stahlhalter, Schraube und Mutter</li> <li><b>10 Lux</b></li> <li>mit <b>deutschem Prüfzeichen</b></li> <li>mit integriertem Reflektor</li> <li>mit <b>Ein-/Ausschalter</b> (für Front- und Rücklicht)</li> <li>2 im Gehäuse <b>integrierte Flachsteckanschlüsse</b></li> <li>mit <b>Doppelkabel</b>, 100 cm</li> <li>Montageverpackung</li> </ul>	<b>LED DYNAMO HEAD LAMP</b> <ul style="list-style-type: none"> <li>white, <b>super bright LED</b></li> <li>steel bracket, screw and nut</li> <li><b>10 Lux</b></li> <li>with <b>German approval number</b></li> <li>with integrated reflector</li> <li>with <b>on/off switch</b> (for front and rear light)</li> <li>2 <b>flat plugs integrated</b> in the housing</li> <li>with <b>double cable</b>, 100 cm</li> <li>OEM</li> </ul> <p style="text-align: right;">UVP 9,90 €</p>	 <p>10 LUX</p> <p>ON/OFF</p> 
<b>461689</b> 50/10	<b>LED-DYNAMOSCHEINWERFER</b> <ul style="list-style-type: none"> <li>weiße, <b>superhelle LED</b></li> <li>mit <b>Halter</b></li> <li><b>14 Lux</b></li> <li>mit <b>deutschem Prüfzeichen</b></li> <li>mit integriertem Reflektor</li> <li>mit <b>Ein-/Ausschalter</b> (für Front- und Rücklicht)</li> <li>2 im Gehäuse <b>integrierte Flachsteckanschlüsse</b></li> <li>mit <b>Doppelkabel</b>, 100 cm</li> <li>Montageverpackung</li> </ul>	<b>LED DYNAMO HEAD LAMP</b> <ul style="list-style-type: none"> <li>white, <b>super bright LED</b></li> <li>with <b>bracket</b></li> <li><b>14 Lux</b></li> <li>with <b>German approval number</b></li> <li>with integrated reflector</li> <li>with <b>on/off switch</b> (for front and rear light)</li> <li>2 <b>flat plugs integrated</b> in the housing</li> <li>with <b>double cable</b>, 100 cm</li> <li>OEM</li> </ul> <p style="text-align: right;">UVP 8,90 €</p>	 <p>14 LUX</p> <p>ON/OFF</p> 
<b>460046</b> 60 <b>460041</b> 50	<b>HALOGEN-DYNAMOSCHEINWERFER</b> <ul style="list-style-type: none"> <li>6 V/2,4 W</li> <li>mit <b>deutschem Prüfzeichen</b></li> <li>mit <b>integriertem Reflektor</b></li> <li><b>10 Lux</b></li> <li>2 im Gehäuse <b>integrierte Flachsteckanschlüsse</b></li> <li>mit <b>Doppelkabel</b>, 60 cm</li> <li>mit <b>Ein-/Ausschalter</b> (für Front- und Rücklicht)</li> <li>mit <b>Halter</b></li> </ul> <p>Montageverpackung</p> <p>auf Smart Eurolochkarte</p>	<b>HALOGEN DYNAMO HEAD LAMP</b> <ul style="list-style-type: none"> <li>6 V/2,4 W</li> <li>with <b>German approval number</b></li> <li>with <b>integrated reflector</b></li> <li><b>10 Lux</b></li> <li>2 <b>flat plugs integrated</b> in the housing</li> <li>with <b>double cable</b>, 60 cm</li> <li>with <b>on/off switch</b> (for front and rear light)</li> <li>with <b>bracket</b></li> </ul> <p>OEM</p> <p>on Smart eurohole card</p> <p style="text-align: right;">UVP 13,90 €</p>	 <p>10 LUX</p> <p>ON/OFF</p>   
<b>461602</b>  <b>461603</b> 100	<b>HALOGEN-DYNAMOSCHEINWERFER</b> <ul style="list-style-type: none"> <li>6 V/2,4 W</li> <li><b>10 Lux</b></li> <li>mit <b>deutschem Prüfzeichen</b></li> <li>mit <b>integriertem Reflektor</b></li> <li>zwei im Gehäuse <b>integrierte Flachsteckanschlüsse</b></li> <li>mit <b>Doppelkabel</b>, 100 cm</li> <li>mit <b>Ein-/Ausschalter</b> (für Front- und Rücklicht)</li> </ul> <p>Montageverpackung</p> <p>Anlun Eurolochbox</p>	<b>HALOGEN DYNAMO HEAD LAMP</b> <ul style="list-style-type: none"> <li>6 V/2,4 W</li> <li><b>10 Lux</b></li> <li>with <b>German approval number</b></li> <li>with <b>integrated reflector</b></li> <li>two <b>flat plugs integrated</b> in the housing</li> <li>with <b>double cable</b>, 100 cm</li> <li>with <b>on/off switch</b> (for front and rear light)</li> </ul> <p>OEM</p> <p>Anlun eurohole box</p> <p style="text-align: right;">UVP 7,90 €</p>	 <p>10 LUX</p> <p>ON/OFF</p>   

ART.-NR.	BESCHREIBUNG	DESCRIPTION	
	<b>HALOGEN-DYNAMO-SCHEINWERFER</b> <ul style="list-style-type: none"> <li>• 6 V/2,4 W</li> <li>• <b>10 Lux</b></li> <li>• mit <b>deutschem Prüfzeichen</b></li> <li>• mit <b>integriertem Reflektor</b></li> <li>• zwei im Gehäuse <b>integrierte Flachsteckanschlüsse</b></li> </ul>	<b>HALOGEN DYNAMO HEAD LAMP</b> <ul style="list-style-type: none"> <li>• 6 V/2.4 W</li> <li>• <b>10 Lux</b></li> <li>• with <b>German approval number</b></li> <li>• with <b>integrated reflector</b></li> <li>• two <b>flat plugs integrated</b> in the housing</li> </ul>	
<b>461636</b>	Montageverpackung	OEM	
<b>461637</b> 100	Anlun Eurolochbox	Anlun eurohole box	UVP 6,90 €
	<b>SCHEINWERFER</b> <ul style="list-style-type: none"> <li>• 6 V/2,4 W</li> <li>• Gehäuse aus schwarzem Kunststoff</li> <li>• mit <b>integriertem Reflektor</b></li> <li>• mit Kabel, 50 cm</li> <li>• mit Einfach-Flachsteckanschluss</li> </ul>	<b>HEAD LAMP</b> <ul style="list-style-type: none"> <li>• 6 V/2.4 W</li> <li>• housing made of black plastic</li> <li>• with <b>integrated reflector</b></li> <li>• with cable, 50 cm</li> <li>• with single flat plug</li> </ul>	
<b>461535</b> 200	Montageverpackung	OEM	
<b>461530</b> 100	Anlun Eurolochbox	Anlun eurohole box	UVP 3,90 €
	Ohne deutsches Prüfzeichen - Verkauf und Nutzung im Geltungsbereich der StVZO (Deutschland) unzulässig (Abgabe nur an außerdeutsche Kunden).		
	<b>SCHEINWERFER</b> <ul style="list-style-type: none"> <li>• 6 V/2,4 W</li> <li>• verchromt</li> <li>• mit Kabel, 100 cm</li> <li>• mit <b>Außenanschluss</b></li> </ul>	<b>HEAD LAMP</b> <ul style="list-style-type: none"> <li>• 6 V/2.4 W</li> <li>• c. p.</li> <li>• with cable, 100 cm</li> <li>• with <b>outside pole</b></li> </ul>	
	Gehäuse aus <b>Stahl</b>	housing made of <b>steel</b>	
<b>461317</b>	Montageverpackung	OEM	
<b>461312</b> 100	Anlun Eurolochbox	Anlun eurohole box	UVP 3,90 €
<b>460267</b> 100	<ul style="list-style-type: none"> <li>• Gehäuse aus Kunststoff</li> <li>• mit Kabel, 100 cm</li> <li>• mit Innenanschluss</li> <li>• Anlun Eurolochbox</li> </ul>	<ul style="list-style-type: none"> <li>• housing made of plastic</li> <li>• with cable, 100 cm</li> <li>• with inner pole</li> <li>• Anlun eurohole box</li> </ul>	
	Ohne deutsches Prüfzeichen - Verkauf und Nutzung im Geltungsbereich der StVZO (Deutschland) unzulässig (Abgabe nur an außerdeutsche Kunden).		

**BATTERY**
**BATTERY**

	<b>BATTERIESCHEINWERFER &gt;REFLEX LIGHT&lt;</b> <ul style="list-style-type: none"> <li>• weiße <b>Hochleistungs-LED</b></li> <li>• <b>integrierter Reflektor</b></li> <li>• mit optischer Linse für fokussierte Ausleuchtung</li> <li>• <b>Niro-Stahlhalter</b></li> <li>• inkl. <b>Batterien</b> (2 x AA)</li> </ul>	<b>BATTERY LAMP &gt;REFLEX LIGHT&lt;</b> <ul style="list-style-type: none"> <li>• white <b>super bright LED</b></li> <li>• <b>integrated reflector</b></li> <li>• with optical lens for focused illumination</li> <li>• <b>stainless steel bracket</b></li> <li>• incl. <b>batteries</b> (2 x AA)</li> </ul>	
<b>460073</b> 80/40	Montageverpackung	OEM	
<b>460074</b> 48	auf Smart Eurolochkarte	on Smart eurohole card	UVP 16,90 €
	Ohne deutsches Prüfzeichen - Verkauf und Nutzung im Geltungsbereich der StVZO (Deutschland) unzulässig (Abgabe nur an außerdeutsche Kunden).		

ART.-NR. 	BESCHREIBUNG	DESCRIPTION	
<b>460072</b> 50/10	<b>BATTERIESCHEINWERFER</b> <b>&gt;LUXMAX 15&lt;</b> <ul style="list-style-type: none"> <li>• 1 weiße Nichia <b>Hochleistungs-LED</b></li> <li>• <b>ansprechendes, modernes Design</b></li> <li>• <b>2 Funktionen (Dauer- und Blinklicht)</b></li> <li>• <b>15 LUX</b></li> <li>• <b>integrierter Reflektor</b></li> <li>• mit Halter</li> <li>• inkl. <b>Batterien</b> (2 x AAA)</li> <li>• auf Smart Eurolochkarte</li> </ul> <p>Ohne deutsches Prüfzeichen - Verkauf und Nutzung im Geltungsbereich der StVZO (Deutschland) unzulässig (Abgabe nur an außerdeutsche Kunden).</p>	<b>BATTERY LAMP</b> <b>&gt;LUXMAX 15&lt;</b> <ul style="list-style-type: none"> <li>• 1 white Nichia <b>high performance LED</b></li> <li>• <b>attractive, modern design</b></li> <li>• <b>2 functions (steady and flashing light)</b></li> <li>• <b>15 LUX</b></li> <li>• <b>integrated reflector</b></li> <li>• with bracket</li> <li>• incl. <b>batteries</b> (2 x AAA)</li> <li>• on Smart eurohole card</li> </ul> <p>UVP 11,90 €</p>	
<b>461630</b> Montageverpackung  <b>461631</b> auf Anlun Eurolochkarte 50/10	<b>BATTERIESCHEINWERFER</b> <ul style="list-style-type: none"> <li>• 1 weiße <b>1 Watt LED</b></li> <li>• <b>2 Funktionen: 20 / 10 Lux</b></li> <li>• mit integriertem Reflektor</li> <li>• mit <b>deutschem Prüfzeichen</b></li> <li>• mit <b>Niro-Stahlhalter</b></li> <li>• inkl. <b>Batterien</b> (2 x AA)</li> <li>• mit Batteriezustandsanzeige</li> </ul>	<b>BATTERY LAMP</b> <ul style="list-style-type: none"> <li>• 1 white <b>1 Watt LED</b></li> <li>• <b>2 functions: 20 / 10 Lux</b></li> <li>• with integrated reflector</li> <li>• with <b>German approval number</b></li> <li>• with <b>stainless steel</b> bracket</li> <li>• incl. <b>batteries</b> (2 x AA)</li> <li>• with battery level indicator</li> </ul> <p>OEM on Anlun eurohole card</p> <p>UVP 14,90 €</p>	
<b>461692</b> 50/10	<b>BATTERIESCHEINWERFER</b> <ul style="list-style-type: none"> <li>• 1 weiße <b>LED</b></li> <li>• <b>2 Funktionen</b> (Dauer- und Blinklicht)</li> <li>• mit integriertem Reflektor</li> <li>• mit Halter</li> <li>• inkl. <b>Batterien</b> (2 x AAA)</li> <li>• auf Anlun Eurolochkarte</li> </ul>	<b>BATTERY LAMP</b> <ul style="list-style-type: none"> <li>• 1 white <b>LED</b></li> <li>• <b>2 functions</b> (steady and flashing light)</li> <li>• with integrated reflector</li> <li>• with bracket</li> <li>• incl. <b>batteries</b> (2 x AAA)</li> <li>• on Anlun eurohole card</li> </ul> <p>UVP 6,90 €</p>	
<b>461694</b> 100	<ul style="list-style-type: none"> <li>• mit <b>2 LEDs</b></li> <li>• im Einzelkarton</li> </ul> <p>Ohne deutsches Prüfzeichen - Verkauf und Nutzung im Geltungsbereich der StVZO (Deutschland) unzulässig (Abgabe nur an außerdeutsche Kunden).</p>	<ul style="list-style-type: none"> <li>• with <b>2 LEDs</b></li> <li>• in box</li> </ul> <p>UVP 5,90 €</p>	
<b>460085</b> 200	<b>BATTERIESCHEINWERFER</b> <ul style="list-style-type: none"> <li>• 3 weiße <b>LEDs</b></li> <li>• mit integriertem Reflektor</li> <li>• inkl. <b>Batterien</b> (3 x AAA)</li> <li>• Montageverpackung</li> </ul> <p>Ohne deutsches Prüfzeichen - Verkauf und Nutzung im Geltungsbereich der StVZO (Deutschland) unzulässig (Abgabe nur an außerdeutsche Kunden).</p>	<b>BATTERY LAMP</b> <ul style="list-style-type: none"> <li>• 3 white <b>LEDs</b></li> <li>• with integrated reflector</li> <li>• incl. <b>batteries</b> (3 x AAA)</li> <li>• OEM</li> </ul> <p>UVP 4,90 €</p>	
<b>460088</b> schwarz / verchromt  <b>460089</b> verchromt 100	<b>BATTERIESCHEINWERFER</b> <ul style="list-style-type: none"> <li>• 3 weiße <b>LEDs</b></li> <li>• inkl. <b>Batterien</b> (3 x AAA)</li> <li>• Montageverpackung</li> </ul>	<b>BATTERY LAMP</b> <ul style="list-style-type: none"> <li>• 3 white <b>LEDs</b></li> <li>• incl. <b>batteries</b> (3 x AAA)</li> <li>• OEM</li> </ul> <p>black / c. p. c.p.</p> <p>UVP 5,90 €</p>	



**ART.-NR.    BESCHREIBUNG    DESCRIPTION**

# RÜCKLICHTER / REAR LIGHTS

**DYNAMO**
**DYNAMO**
**DYNAMORÜCKLICHT  
>STANDING LIGHT<**

- mit **Standlichtfunktion**
- mit **einer superhellen LED**
- mit **deutschem Prüfzeichen**
- mit **Doppelanschluss** (+ und -)
- für Schutzblechmontage
- inkl. Mutter und Federring

**466933** Montageverpackung  
100/25

**466934** auf Smart Eurolochkarte  
120/30

**DYNAMO REAR LIGHT  
>STANDING LIGHT<**

- with **standlight function**
- with **one super bright LED**
- with **German approval number**
- with **double connection** (+ and -)
- for mudguard installation
- incl. nut and springwasher

OEM

on Smart eurohole card

UVP 9,90 €

**STANDLIGHT**
**SMART®**

**LED** →

**• 466929 DYNAMORÜCKLICHT**

- mit **Standlichtfunktion**
- mit **3 LEDs**
- mit **deutschem Prüfzeichen**
- mit **Doppelanschluss** (+ und -)
- für Schutzblechmontage
- inkl. Mutter und Federring
- Montageverpackung

250

**DYNAMO REAR LIGHT**

- with **standlight function**
- with **3 LEDs**
- with **German approval number**
- with **double connection** (+ and -)
- for mudguard installation
- incl. nut and springwasher
- OEM

UVP 8,90 €

**LED** →

**NICE  
PRICE**
**DYNAMORÜCKLICHT**

- Mutter und Federring montiert
- für Schutzblechmontage
- Montageverpackung

**• 466913** mit **LED**  
250

**DYNAMO REAR LIGHT**

- nut and springwasher mounted
- for mudguard installation
- OEM

 with **LED**

UVP 1,90 €

**LED** →

**466911** mit Birne 6 V/0,6 W  
250

Ohne deutsches Prüfzeichen - Verkauf und Nutzung im Geltungsbereich der StVZO (Deutschland) unzulässig (Abgabe nur an außerdeutsche Kunden).

UVP 1,90 €

with bulb 6 V/0.6 W

**466940 RETRO-RÜCKLICHT**

- mit 6 V/0,5 W Birne
- mit Befestigungsschelle für Hinterradstrebe
- mit 160 cm langem Kabel
- mit roter Linse

500/10

**RETRO REAR LIGHT**

- with 6 V/0.5 W bulb
- with clip for fitting to seat stay
- with 160 cm long cable
- with red lens

Ohne deutsches Prüfzeichen - Verkauf und Nutzung im Geltungsbereich der StVZO (Deutschland) unzulässig (Abgabe nur an außerdeutsche Kunden).

UVP 1,90 €



ART.-NR.	BESCHREIBUNG	DESCRIPTION	
<b>BATTERY</b>		<b>BATTERY</b>	
	<b>LED-BATTERIERÜCKLICHT</b> <ul style="list-style-type: none"> <li>für Schutzblechmontage</li> <li>transparent</li> <li>roter Reflektor</li> <li>inkl. <b>Batterien</b> (2 x AAA)</li> </ul> <p>mit 3 <b>LEDs</b></p> <p><b>466935</b> Montageverpackung <b>466936</b> auf Anlun Eurolochkarte</p> <p>100</p>	<b>LED BATTERY REAR LIGHT</b> <ul style="list-style-type: none"> <li>for mudguard installation</li> <li>transparent</li> <li>red reflector</li> <li>inkl. <b>batteries</b> (2 x AAA)</li> </ul> <p>with 3 <b>LEDs</b></p> <p>OEM on Anlun eurohole card</p> <p>UVP 4,90 €</p>	
	<p>mit <b>superheller</b> LED</p> <ul style="list-style-type: none"> <li><b>466942</b> Montageverpackung <b>466943</b> auf Anlun Eurolochkarte</li> </ul> <p>100</p> <p>Ohne deutsches Prüfzeichen - Verkauf und Nutzung im Geltungsbereich der StVZO (Deutschland) unzulässig (Abgabe nur an außerdeutsche Kunden).</p>	<p>with <b>super bright</b> LED</p> <p>OEM on Anlun eurohole card</p> <p>UVP 5,90 €</p>	
<b>E-BIKE</b>		<b>E-BIKE</b>	
<p><b>466151</b> 100/20</p>	<b>E-BIKE-GEPÄCKTRÄGER-RÜCKLICHT ›HELIOS E BRAKE‹</b> <ul style="list-style-type: none"> <li>6 - 48 V DC/0,6 W</li> <li><b>2 superhelle, rote LEDs an den Seiten</b></li> <li><b>COB LED</b> (21 Chips)</li> <li>mit <b>deutschem Prüfzeichen</b></li> <li>mit <b>Bremslichtfunktion</b></li> <li>integrierter Z-Reflektor</li> <li>für Lochabstand 80 mm</li> <li>2 im Gehäuse integrierte Flachsteckanschlüsse</li> <li>auf M-Wave Eurolochkarte</li> </ul>	<b>E-BIKE CARRIER REAR LIGHT ›HELIOS E BRAKE‹</b> <ul style="list-style-type: none"> <li>6 - 48 V DC/0,6 W</li> <li><b>2 super bright, red LEDs at the sides</b></li> <li><b>COB LED</b> (21 chips)</li> <li>with <b>German approval number</b></li> <li>with <b>brake light function</b></li> <li>integrierter Z-reflektor</li> <li>for hole distance 80 mm</li> <li>2 flat plugs integrated in the housing</li> <li>on M-Wave eurohole card</li> </ul> <p>UVP 14,90 €</p>	
<p><b>466460</b> 80/20</p>	<b>E-BIKE GEPÄCKTRÄGER-RÜCKLICHT ›VULCAN DUE‹</b> <ul style="list-style-type: none"> <li>6 - 15 V DC/1,3 W</li> <li>mit <b>5 roten LEDs</b></li> <li><b>20 Lumen</b></li> <li>Abstrahlwinkel 220°</li> <li>mit <b>deutschem Prüfzeichen</b></li> <li>für Lochabstand 50 mm</li> <li>nur ca. <b>63 x 20 mm</b></li> <li>Kabellänge: 120 cm</li> <li>inkl. Befestigungsteilen</li> <li>auf Smart Eurolochkarte</li> </ul>	<b>E-BIKE CARRIER REAR LIGHT ›VULCAN DUE‹</b> <ul style="list-style-type: none"> <li>6 - 15 V DC/1,3 W</li> <li>with <b>5 red LEDs</b></li> <li><b>20 Lumen</b></li> <li>radiation angle 220°</li> <li>with <b>German approval number</b></li> <li>for hole distance 50 mm</li> <li>only approx. <b>63 x 20 mm</b></li> <li>cable length: 120 cm</li> <li>incl. mounting parts</li> <li>on Smart eurohole card</li> </ul> <p>UVP 11,90 €</p>	
<p><b>466997</b> 200/20</p>	<b>E-BIKE-GEPÄCKTRÄGER-RÜCKLICHT ›REFO MINI‹</b> <ul style="list-style-type: none"> <li>6 - 60 V DC</li> <li><b>1 superhelle, rote Osram LED</b></li> <li>mit <b>deutschem Prüfzeichen</b></li> <li>integrierter <b>Z-Reflektor</b></li> <li>für Lochabstand 80 mm</li> <li>inkl. Zahnscheiben, Schrauben und Muttern</li> <li>2 im Gehäuse integrierte Flachsteckanschlüsse</li> <li>Montageverpackung</li> </ul>	<b>E-BIKE CARRIER REAR LIGHT ›REFO MINI‹</b> <ul style="list-style-type: none"> <li>6 - 60 V DC</li> <li><b>1 super bright, red Osram LED</b></li> <li>with <b>German approval number</b></li> <li>integrierter <b>Z-reflector</b></li> <li>for hole distance 80 mm</li> <li>incl. lock washers, screws and nuts</li> <li>2 flat plugs integrated in the housing</li> <li>OEM</li> </ul> <p>UVP 11,90 €</p>	

ART.-NR.	BESCHREIBUNG	DESCRIPTION	
• 466150 100	<b>E-BIKE-GEPÄCKTRÄGER-RÜCKLICHT ›HELIOS E‹</b> <ul style="list-style-type: none"> <li>• 6 - 48 V DC/0,6 W</li> <li>• 3 superhelle, rote <b>LEDs</b></li> <li>• mit <b>deutschem Prüfzeichen</b></li> <li>• integrierter Z-Reflektor</li> <li>• für Lochabstand 80 mm</li> <li>• 2 im Gehäuse integrierte Flachsteckanschlüsse</li> <li>• Montageverpackung</li> </ul>	<b>E-BIKE CARRIER REAR LIGHT ›HELIOS E‹</b> <ul style="list-style-type: none"> <li>• 6 - 48 V DC/0,6 W</li> <li>• 3 super bright, red <b>LEDs</b></li> <li>• with <b>German approval number</b></li> <li>• integrated Z-reflector</li> <li>• for hole distance 80 mm</li> <li>• 2 flat plugs integrated in the housing</li> <li>• OEM</li> </ul>	    <p>UVP 6,90 €</p>
<b>NEW</b> 466154 100	<b>E-BIKE-GEPÄCKTRÄGER-RÜCKLICHT ›HELIOS E-F‹</b> <ul style="list-style-type: none"> <li>• 6 - 48 V DC/0,5 W</li> <li>• 2 superhelle, rote <b>LEDs</b></li> <li>• mit <b>deutschem Prüfzeichen</b></li> <li>• integrierter Z-Reflektor</li> <li>• für Schutzblechmontage</li> <li>• inkl. Mutter</li> <li>• Montageverpackung</li> </ul>	<b>E-BIKE CARRIER REAR LIGHT ›HELIOS E-F‹</b> <ul style="list-style-type: none"> <li>• 6 - 48 V DC/0,5 W</li> <li>• 2 super bright, red <b>LEDs</b></li> <li>• with <b>German approval number</b></li> <li>• integrated Z-reflector</li> <li>• for mudguard installation</li> <li>• incl. nut</li> <li>• OEM</li> </ul>	    <p>UVP 5,90 €</p>







UNSERE LITEMOVE-RÜCKLICHTER FINDEN SIE AB SEITE 646. | YOU WILL FIND OUR LITEMOVE REAR LIGHTS AT PAGE 646.

DYNAMO

DYNAMO

466980 50/10	<b>DYNAMO-GEPÄCKTRÄGER-RÜCKLICHT ›STANDLIGHT‹</b> <ul style="list-style-type: none"> <li>• mit superheller <b>LED</b></li> <li>• mit <b>Standlichtfunktion</b></li> <li>• 220° Abstrahlwinkel</li> <li>• mit <b>deutschem Prüfzeichen</b></li> <li>• je 2 <b>Doppelanschlüsse</b> (für Kabelschuh, bzw. abisoliertes Kabelende)</li> <li>• integrierter Z-Reflektor</li> <li>• für Lochabstand 80 mm</li> <li>• inkl. Zahnscheiben und Muttern</li> <li>• auf Smart Eurolochkarte</li> </ul>	<b>DYNAMO CARRIER REAR LIGHT ›STANDLIGHT‹</b> <ul style="list-style-type: none"> <li>• with super bright <b>LED</b></li> <li>• with <b>standlight function</b></li> <li>• 220° beam angle</li> <li>• with <b>German approval number</b></li> <li>• each 2 <b>double connections</b> (for cable shoe/removed cable insulation)</li> <li>• integrated Z-reflector</li> <li>• for hole distance 80 mm</li> <li>• incl. lock washers and nuts</li> <li>• on Smart eurohole card</li> </ul>	     <p>UVP 12,90 €</p>
• 466905 100	<b>DYNAMO-GEPÄCKTRÄGER-RÜCKLICHT ›HELIOS D‹</b> <ul style="list-style-type: none"> <li>• 1 <b>superhelle, rote LED</b></li> <li>• 6 V/0,5 W</li> <li>• mit <b>Standlichtfunktion</b></li> <li>• mit <b>deutschem Prüfzeichen</b></li> <li>• integrierter Z-Reflektor</li> <li>• Stecker für <b>Doppelanschluss</b> (+ und -)</li> <li>• für Lochabstand <b>50 und 80 mm</b></li> <li>• inkl. Befestigungsschrauben und Muttern</li> <li>• Montageverpackung</li> </ul>	<b>DYNAMO CARRIER REAR LIGHT ›HELIOS D‹</b> <ul style="list-style-type: none"> <li>• 1 <b>super bright, red LED</b></li> <li>• 6 V/0,5 W</li> <li>• with <b>standlight function</b></li> <li>• with <b>German approval number</b></li> <li>• integrated Z-reflector</li> <li>• plug for <b>double connection</b> (+ and -)</li> <li>• for hole distance <b>50 and 80 mm</b></li> <li>• incl. fastening screws and nuts</li> <li>• OEM</li> </ul>	    <p>UVP 6,90 €</p>
• 466979 100	<b>DYNAMO-GEPÄCKTRÄGER-RÜCKLICHT</b> <ul style="list-style-type: none"> <li>• rote LED erzeugt <b>Leuchtband</b></li> <li>• Doppelanschluss (+ und -)</li> <li>• integrierter Z-Reflektor</li> <li>• mit <b>deutschem Prüfzeichen</b></li> <li>• für Lochabstand 80 mm</li> <li>• inkl. Befestigungsmuttern</li> <li>• Montageverpackung</li> </ul>	<b>DYNAMO CARRIER REAR LIGHT</b> <ul style="list-style-type: none"> <li>• rote LED generates <b>luminous row</b></li> <li>• double connection (+ and -)</li> <li>• integrated Z-reflector</li> <li>• mit <b>German approval number</b></li> <li>• for hole distance 80 mm</li> <li>• incl. fastening nuts</li> <li>• OEM</li> </ul>	  <p>UVP 4,90 €</p>















ART.-NR. 	BESCHREIBUNG	DESCRIPTION	
<p>• <b>466955</b> 200</p>	<p><b>DYNAMO-GEPAECKTRÄGER-RÜCKLICHT</b></p> <ul style="list-style-type: none"> <li>• mit <b>2 roten LEDs</b></li> <li>• mit Kabel 160 cm</li> <li>• für Lochabstand 80 mm</li> <li>• inkl. Befestigungsbolzen, Muttern und Beilagscheiben</li> <li>• Montageverpackung</li> </ul> <p>Ohne deutsches Prüfzeichen - Verkauf und Nutzung im Geltungsbereich der StVZO (Deutschland) unzulässig (Abgabe nur an außerdeutsche Kunden).</p>	<p><b>DYNAMO CARRIER REAR LIGHT</b></p> <ul style="list-style-type: none"> <li>• with <b>2 red LEDs</b></li> <li>• with cable 160 cm</li> <li>• for hole distance 80 mm</li> <li>• incl. fastening bolts, nuts and washers</li> <li>• OEM</li> </ul> <p>UVP 3,90 €</p>	
<p><b>BATTERY</b> <span style="margin-left: 300px;"><b>LED</b></span> <span style="float: right;"><b>BATTERY</b></span></p>			
<p><b>466983</b> 100</p>	<p><b>BATTERIE-GEPAECKTRÄGER-RÜCKLICHT ›TAIL LIGHT‹</b></p> <ul style="list-style-type: none"> <li>• mit <b>roter LED</b></li> <li>• mit Befestigungsmuttern</li> <li>• mit <b>deutschem Prüfzeichen</b></li> <li>• integrierter Z-Reflektor</li> <li>• mit Batteriezustandsanzeige</li> <li>• für Lochabstand 80 mm</li> <li>• für 2x AA Batterien (nicht inkl.)</li> <li>• auf Smart Eurolochkarte</li> </ul>	<p><b>BATTERY CARRIER REAR LIGHT ›TAIL LIGHT‹</b></p> <ul style="list-style-type: none"> <li>• with <b>red LED</b></li> <li>• with fastening nuts</li> <li>• with <b>German approval number</b></li> <li>• integrated Z-reflector</li> <li>• with battery level indicator</li> <li>• for hole distance 80 mm</li> <li>• for 2x AA batteries (not incl.)</li> <li>• on Smart eurohole card</li> </ul> <p>UVP 14,90 €</p>	
<p><b>466987</b> 100/20</p>	<p><b>BATTERIE-GEPAECKTRÄGER-RÜCKLICHT ›TUNNEL‹</b></p> <ul style="list-style-type: none"> <li>• rote <b>Osram LED</b> erzeugt <b>Leuchtband mit 220° Sichtbarkeit</b></li> <li>• Batteriezustandsanzeige</li> <li>• integrierter Z-Reflektor</li> <li>• mit Befestigungsmuttern</li> <li>• mit <b>deutschem Prüfzeichen</b></li> <li>• für Lochabstand 80 mm</li> <li>• inkl. Batterien (2x AAA)</li> <li>• auf Smart Eurolochkarte</li> </ul>	<p><b>BATTERY CARRIER REAR LIGHT ›TUNNEL‹</b></p> <ul style="list-style-type: none"> <li>• red <b>Osram LED</b> generates <b>luminous row with 220° visibility</b></li> <li>• battery level indicator</li> <li>• integrated Z-reflector</li> <li>• with fastening nuts</li> <li>• mit <b>German approval number</b></li> <li>• for hole distance 80 mm</li> <li>• incl. batteries (2x AAA)</li> <li>• auf Smart Eurolochkarte</li> </ul> <p>UVP 11,90 €</p>	
<p>• <b>466950</b> 100/20</p>	<p><b>AKKU-GEPAECKTRÄGER-RÜCKLICHT ›HELIOS USB‹</b></p> <ul style="list-style-type: none"> <li>• <b>1 superhelle, rote LED</b></li> <li>• 3,7 V/300 mAh</li> <li>• mit <b>Lithium-Polymer Akku</b></li> <li>• mit <b>deutschem Prüfzeichen</b></li> <li>• integrierter Z-Reflektor</li> <li>• mit <b>Ladezustandsanzeige</b></li> <li>• für Lochabstand 50 und 80 mm</li> <li>• <b>2 in 1:</b> Gummihalter (Art. 223561) für Sattelstützmontage und Befestigungsschrauben für Gepäckträgermontage</li> <li>• <b>inkl. USB-Kabel</b></li> <li>• auf M-Wave Eurolochkarte</li> </ul>	<p><b>RECHARGEABLE CARRIER REAR LIGHT ›HELIOS USB‹</b></p> <ul style="list-style-type: none"> <li>• <b>1 super bright, red LED</b></li> <li>• 3.7 V/300 mAh</li> <li>• with <b>lithium polymer rechargeable battery</b></li> <li>• with <b>German approval number</b></li> <li>• integrated Z-reflector</li> <li>• with <b>charge control indicator</b></li> <li>• for hole distance 50 and 80 mm</li> <li>• <b>2 in 1:</b> rubber bracket (art. 223561) for seat post mounting and fastening screws for carrier mounting</li> <li>• <b>incl. USB cable</b></li> <li>• on M-Wave eurohole card</li> </ul> <p>UVP 11,90 €</p>	
<p><b>466995</b> 100/20</p>	<p><b>BATTERIE-GEPAECKTRÄGER-RÜCKLICHT</b></p> <ul style="list-style-type: none"> <li>• mit <b>roter LED</b></li> <li>• mit Befestigungsschrauben</li> <li>• mit integriertem Reflektor</li> <li>• für Lochabstand 80 mm</li> <li>• inkl. <b>Batterien</b> (2 x AAA)</li> <li>• Montageverpackung</li> </ul> <p>Ohne deutsches Prüfzeichen - Verkauf und Nutzung im Geltungsbereich der StVZO (Deutschland) unzulässig (Abgabe nur an außerdeutsche Kunden).</p>	<p><b>BATTERY CARRIER REAR LIGHT</b></p> <ul style="list-style-type: none"> <li>• with <b>red LED</b></li> <li>• with fastening screws</li> <li>• with integrated reflector</li> <li>• for hole distance 80 mm</li> <li>• incl. <b>batteries</b> (2 x AAA)</li> <li>• OEM</li> </ul> <p>UVP 8,90 €</p>	

ART.-NR.	BESCHREIBUNG	DESCRIPTION	
<p><b>466925</b> 100</p> <p><b>466926</b> 100/20</p>	<p><b>BATTERIE-GE PÄCKTRÄGER-RÜCKLICHT ›HELIOS B‹</b></p> <ul style="list-style-type: none"> <li>• 2 superhelle, rote LEDs</li> <li>• mit deutschem Prüfzeichen</li> <li>• integrierter Z-Reflektor</li> <li>• mit Batteriezustandsanzeige</li> <li>• inkl. Batterien (2x AAA)</li> <li>• für Lochabstand 50 und 80 mm</li> <li>• inkl. Befestigungsschrauben und Muttern</li> </ul> <p>Montageverpackung</p> <p>auf M-Wave Eurolochkarte</p>	<p><b>BATTERY CARRIER REAR LIGHT ›HELIOS B‹</b></p> <ul style="list-style-type: none"> <li>• 2 super bright, red LEDs</li> <li>• with German approval number</li> <li>• integrated Z-reflector</li> <li>• with battery level indicator</li> <li>• incl. Batteries (2x AAA)</li> <li>• for hole distance 50 and 80 mm</li> <li>• incl. fastening screws und nuts</li> </ul> <p>OEM</p> <p>on M-Wave eurohole card</p> <p>UVP 8,90 €</p>	<p>2 LEDs</p>
<p>• <b>466990</b> 100</p>	<p><b>BATTERIE-GE PÄCKTRÄGER-RÜCKLICHT</b></p> <ul style="list-style-type: none"> <li>• mit 3 LEDs</li> <li>• mit deutschem Prüfzeichen</li> <li>• mit Batteriezustandsanzeige</li> <li>• mit integriertem Z-Reflektor</li> <li>• für Lochabstand 80 mm</li> <li>• inkl. Batterien (2x AA)</li> <li>• Montageverpackung</li> </ul>	<p><b>BATTERY CARRIER REAR LIGHT</b></p> <ul style="list-style-type: none"> <li>• with 3 LEDs</li> <li>• with German approval number</li> <li>• with battery level indicator</li> <li>• with integrated Z-reflector</li> <li>• for hole distance 80 mm</li> <li>• incl. batteries (2x AA)</li> <li>• OEM</li> </ul> <p>UVP 7,90 €</p>	
<p>• <b>466902</b> <b>466903</b> 100</p>	<p><b>BATTERIE-GE PÄCKTRÄGER-RÜCKLICHT</b></p> <ul style="list-style-type: none"> <li>• rote LED erzeugt Leuchtband</li> <li>• mit integriertem Reflektor</li> <li>• inkl. Batterien (2x AA)</li> <li>• inkl. Befestigungsschrauben, Beilagscheiben und Muttern</li> <li>• für Lochabstand 80 mm</li> </ul> <p>Montageverpackung</p> <p>auf Anlun Eurolochkarte</p> <p>Ohne deutsches Prüfzeichen - Verkauf und Nutzung im Geltungsbereich der StVZO (Deutschland) unzulässig (Abgabe nur an außerdeutsche Kunden).</p>	<p><b>BATTERY CARRIER REAR LIGHT</b></p> <ul style="list-style-type: none"> <li>• red LED generates luminous row</li> <li>• with integrated reflector</li> <li>• incl. batteries (2x AA)</li> <li>• incl. fastening screws, washers and nuts</li> <li>• for hole distance 80 mm</li> </ul> <p>OEM</p> <p>on Anlun eurohole card</p> <p>UVP 6,90 €</p>	
<p>• <b>466960</b> 100</p>	<p><b>BATTERIE-GE PÄCKTRÄGER-RÜCKLICHT</b></p> <ul style="list-style-type: none"> <li>• mit 3 LEDs</li> <li>• mit Befestigungsschrauben</li> <li>• mit integriertem Reflektor</li> <li>• für Lochabstand 80 mm</li> <li>• inkl. Batterien (2x AA)</li> <li>• Montageverpackung</li> </ul> <p>Ohne deutsches Prüfzeichen - Verkauf und Nutzung im Geltungsbereich der StVZO (Deutschland) unzulässig (Abgabe nur an außerdeutsche Kunden).</p>	<p><b>BATTERY CARRIER REAR LIGHT</b></p> <ul style="list-style-type: none"> <li>• with 3 LEDs</li> <li>• with fastening screws</li> <li>• with integrated reflector</li> <li>• for hole distance 80 mm</li> <li>• incl. batteries (2x AA)</li> <li>• OEM</li> </ul> <p>UVP 4,90 €</p>	
<p>• <b>466918</b> 200</p>	<p><b>RÜCKLICHTSCHUTZ</b></p> <ul style="list-style-type: none"> <li>• schwarzer Metallrahmen</li> <li>• variable Befestigungsmöglichkeiten</li> </ul> <p>für Gepäckträger-Rücklichter</p>	<p><b>REAR LIGHT PROTECTOR</b></p> <ul style="list-style-type: none"> <li>• black metal frame</li> <li>• variable opportunities for fixing</li> </ul> <p>for carrier rear lights</p> <p>UVP 0,99 €</p>	
<p><b>466919</b> 330</p>	<p>für Schutzblech-Rücklichter</p>	<p>for mudguard rear lights</p> <p>UVP 1,90 €</p>	
<p><b>460742</b> 250</p>	<p><b>HALTER FÜR LAMPEN</b></p> <ul style="list-style-type: none"> <li>• für Lenker, Sattelstützen, ...</li> <li>• Kunststoff</li> <li>• passend für Ø 25,4 - 31,8 mm</li> <li>• Montageverpackung</li> </ul>	<p><b>HEAD LAMP BRACKET</b></p> <ul style="list-style-type: none"> <li>• for handlebars, seat posts, ...</li> <li>• plastic</li> <li>• suitable for Ø 25.4 - 31.8 mm</li> <li>• OEM</li> </ul> <p>UVP 1,99 €</p>	

# BELEUCHTUNGSZUBEHÖR LIGHTING ACCESSORIES

ART.-NR. 	BESCHREIBUNG	DESCRIPTION	
<b>460741</b> 250	<b>HALTER FÜR FRONTLICHT</b> <ul style="list-style-type: none"> <li>• passend für <b>Suntour (NEX, NEX-E25, NCX, CR)</b>, entsprechenden <b>Zoom Federgabeln</b>, ...</li> <li>• Kunststoff, 45 mm</li> <li>• Montageverpackung</li> </ul>	<b>HEAD LAMP BRACKET</b> <ul style="list-style-type: none"> <li>• suitable for <b>Suntour (NEX, NEX-E25, NCX, CR)</b>, appropriate <b>Zoom suspension forks</b>, ...</li> <li>• plastic, 45 mm</li> <li>• OEM</li> </ul>	 UVP 1,49 €
<b>460736</b> 500/10	<b>LAMPENHALTER</b> <ul style="list-style-type: none"> <li>• <b>Nirosta</b></li> <li>• <b>hochwertige, stabile</b> Ausführung</li> <li>• mit Innensechskant-<b>Nirosta</b>-Schraube, <b>selbstsichernder</b> Mutter und 2 Beilagscheiben</li> </ul>	<b>LAMP BRACKET</b> <ul style="list-style-type: none"> <li>• <b>stainless steel</b></li> <li>• <b>high quality, robust</b> model</li> <li>• with allen screw, <b>stainless steel</b>, <b>self-locking</b> nut and 2 washers</li> </ul>	 UVP 1,49 €
<b>460731</b> 500/100	<b>460731</b> <ul style="list-style-type: none"> <li>• Stahl</li> <li>• <b>extra lang, 70 mm</b></li> <li>• Schraube montiert</li> <li>• auch geeignet für <b>Montage an Vorderradkörben</b> (Art. 431510, ...)</li> </ul>	<b>460731</b> <ul style="list-style-type: none"> <li>• steel</li> <li>• <b>super long, 70 mm</b></li> <li>• incl. bolt mounted</li> <li>• also for <b>mounting on front baskets</b> (art. 431510, ...)</li> </ul>	 UVP 0,99 €
<b>460739</b> 500/100	<b>460739</b> <ul style="list-style-type: none"> <li>• Stahl</li> <li>• <b>low profile</b></li> <li>• mit Schlitz für Reflektor-Montage</li> </ul>	<b>460739</b> <ul style="list-style-type: none"> <li>• steel</li> <li>• <b>low profile</b></li> <li>• with slit for reflector assembling</li> </ul>	 UVP 0,99 €
<b>460866</b> 250/50	<b>DYNAMOHALTER</b> zur Befestigung an der <b>Vorderradgabel</b> , schwarz	<b>DYNAMO BRACKET</b> for fastening on <b>front fork</b> , black	 UVP 0,90 €
<b>460880</b> 500	<b>460880</b> zur Befestigung an der <b>Hinterradstrebe</b>	<b>460880</b> for fastening on <b>rear stay</b>	 UVP 1,50 €
<b>468003</b> 500	<b>DYNAMOKABEL</b> <b>Doppelkabel</b> <ul style="list-style-type: none"> <li>• 2.200 mm gerollt</li> <li>• ein Ende: beide Kabel mit <b>Kabelschuh</b></li> <li>• anderes Ende: <b>1 x Kabelschuh, 1 x Ringöse</b></li> <li>• beide Enden mit Schrumpfschlauch</li> <li>• schwarz/grau</li> </ul>	<b>DYNAMO CABLE</b> <b>double cable</b> <ul style="list-style-type: none"> <li>• 2,200 mm rolled</li> <li>• one end: both cables with <b>cable shoe</b></li> <li>• other end: <b>1 x cable shoe, 1 x ring loop</b></li> <li>• both ends with heat shrink cover</li> <li>• black/grey</li> </ul>	 UVP 1,90 €
<b>468004</b> 2.000/ 200 metres	<b>468004</b> <ul style="list-style-type: none"> <li>• auf 200 m Rolle</li> <li>• schwarz/grau</li> </ul>	<b>468004</b> <ul style="list-style-type: none"> <li>• 200 m on roll</li> <li>• black/grey</li> </ul>	 UVP 0,90 € / m
<b>468005</b> 2.000	<b>Einfachkabel</b> <b>468005</b> 900 mm, gerollt	<b>single cable</b> <b>468005</b> 900 mm, rolled	 UVP 0,49 €
<b>468008</b> 1.000	<b>468008</b> 1.900 mm, gerollt	<b>468008</b> 1,900 mm, rolled	 UVP 0,90 €
<b>461628</b> 100/50	<b>DOPPEL-KABELVERBINDER</b> <ul style="list-style-type: none"> <li>• <b>kein Abisolieren nötig</b></li> <li>• werkzeuglose Montage</li> <li>• inklusive <b>Polfett zur Abdichtung</b></li> <li>• transparenter Kunststoff</li> </ul>	<b>DOUBLE SELF-SEALING CABLE CONNECTOR</b> <ul style="list-style-type: none"> <li>• <b>no stripping necessary</b></li> <li>• toolless mounting</li> <li>• <b>grease filled</b></li> <li>• transparent plastic</li> </ul>	 UVP 0,79 €
<b>461629</b> 1.000	<b>461629</b> 1.000 Stück im Polybeutel	<b>461629</b> 1,000 pcs in PE bag	 UVP 0,79 €













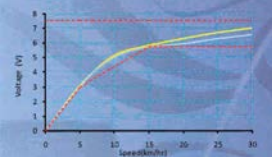
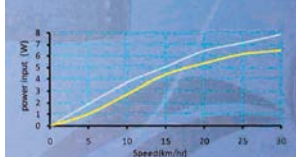
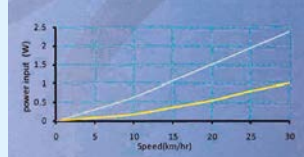

ART.-NR.	BESCHREIBUNG	DESCRIPTION	
<p><b>466670</b> 250 set</p> <p>• <b>466671</b> 7.560/360</p>	<p><b>3M™ SCOTCHLITE SPEICHENREFLEKTOR</b></p> <ul style="list-style-type: none"> <li>• 3M Scotchlite® Reflexmaterial</li> <li>• <b>360° Sichtbarkeit</b></li> <li>• Länge: 70 mm</li> <li>• einfache Montage ohne Werkzeug</li> <li>• mit <b>deutschem Prüfzeichen</b> (gültig bei Anbringung an 36 Speichen in einem Laufrad)</li> </ul> <p>1 Set = 18 Stück in M-Wave Blisterverpackung</p> <p>Montageverpackung</p>	<p><b>3M™ SCOTCHLITE SPOKE REFLECTOR</b></p> <ul style="list-style-type: none"> <li>• 3M Scotchlite® reflective material</li> <li>• <b>360° visibility</b></li> <li>• length: 70 mm</li> <li>• easy mounting without tools</li> <li>• with <b>German approval number</b> (only applies when mounted on 36 spokes in one wheel)</li> </ul> <p>1 set = 18 pcs in M-Wave blister packaging</p> <p>OEM</p>	     <p>UVP 9,90 €</p> <p>UVP 0,59 €</p>
<p>• <b>466603</b> 1.000/20</p> <p><b>466606</b> 100 set</p>	<p><b>SPEICHENREFLEKTOR</b></p> <ul style="list-style-type: none"> <li>• mit <b>deutschem Prüfzeichen</b></li> <li>• 60 mm Klemmweite</li> <li>• <b>Nirosta</b>-Klammern</li> </ul> <p>Montageverpackung</p> <p><b>Setverpackung, 4 Stück</b></p>	<p><b>SPOKE REFLECTOR</b></p> <ul style="list-style-type: none"> <li>• with <b>German approval number</b></li> <li>• 60 mm clamping width</li> <li>• <b>stainless steel</b> clamps</li> </ul> <p>OEM</p> <p><b>set packaging, 4 pcs</b></p>	  <p>UVP 0,59 €</p> <p>UVP 2,90 €</p>
<p>• <b>466612</b> 1.600/40</p>	<ul style="list-style-type: none"> <li>• ohne deutsches Prüfzeichen</li> <li>• Montageverpackung</li> </ul> <p>Ohne deutsches Prüfzeichen - Verkauf und Nutzung im Geltungsbereich der StVZO (Deutschland) unzulässig (Abgabe nur an außerdeutsche Kunden).</p>	<ul style="list-style-type: none"> <li>• without German approval number</li> <li>• OEM</li> </ul> <p>UVP 0,39 €</p>	
<p><b>460800</b> 480</p> <p>• <b>466008</b> 1.000/50</p>	<p><b>REFLEKTOR - VORNE</b></p> <ul style="list-style-type: none"> <li>• Winkel <b>verstellbar</b></li> <li>• mit <b>deutschem Prüfzeichen</b></li> </ul> <ul style="list-style-type: none"> <li>• mit Bolzen, Scheibe und Mutter</li> <li>• ohne deutsches Prüfzeichen</li> </ul> <p>Ohne deutsches Prüfzeichen - Verkauf und Nutzung im Geltungsbereich der StVZO (Deutschland) unzulässig (Abgabe nur an außerdeutsche Kunden).</p>	<p><b>REFLECTOR - FRONT</b></p> <ul style="list-style-type: none"> <li>• angle <b>adjustable</b></li> <li>• with <b>German approval number</b></li> </ul> <p>UVP 0,99 €</p> <ul style="list-style-type: none"> <li>• with bolt, washer and nut</li> <li>• without German approval number</li> </ul> <p>UVP 0,50 €</p>	 
<p><b>460801</b> 480</p> <p>• <b>466308</b> 1.000/50</p>	<p><b>REFLEKTOR - HINTEN</b></p> <ul style="list-style-type: none"> <li>• Winkel <b>verstellbar</b></li> <li>• mit <b>deutschem Prüfzeichen</b></li> </ul> <ul style="list-style-type: none"> <li>• mit Bolzen, Scheibe und Mutter</li> <li>• ohne deutsches Prüfzeichen</li> </ul> <p>Ohne deutsches Prüfzeichen - Verkauf und Nutzung im Geltungsbereich der StVZO (Deutschland) unzulässig (Abgabe nur an außerdeutsche Kunden).</p>	<p><b>REFLECTOR - REAR</b></p> <ul style="list-style-type: none"> <li>• angle <b>adjustable</b></li> <li>• with <b>German approval number</b></li> </ul> <p>UVP 0,99 €</p> <ul style="list-style-type: none"> <li>• with bolt, washer and nut</li> <li>• without German approval number</li> </ul> <p>UVP 0,50 €</p>	 

# REFLEKTOREN REFLECTORS

ART.-NR. 	BESCHREIBUNG	DESCRIPTION	
<b>466451</b> 300	<b>GROSSFLÄCHENREFLEKTOR</b> <ul style="list-style-type: none"> <li>für <b>Gepäckträger</b></li> <li>Trapezform</li> <li>aus extrem <b>schlag-/stoßfestem</b> und <b>recyclbarem</b> Kunststoff</li> <li>integrierter Z-Reflektor</li> <li>für Lochabstand 80 mm</li> <li>inkl. Befestigungsschrauben</li> <li>mit <b>deutschem Prüfzeichen</b></li> </ul>	<b>Z-REFLEKTOR</b> <ul style="list-style-type: none"> <li>for <b>carrier</b></li> <li>trapezium shape</li> <li>made of <b> durable, shockproof</b> and <b>recyclable</b> plastic</li> <li>integrated Z-reflector</li> <li>for hole distance 80 mm</li> <li>incl. fastening screws</li> <li>with <b>German approval number</b></li> </ul>	  <p>UVP 1,50 €</p>
<b>466455</b> 600/100	<ul style="list-style-type: none"> <li>für <b>Gepäckträger</b></li> <li>für Lochabstand <b>50 und 80 mm</b></li> <li>zusätzliche Befestigungsmöglichkeit in der Mitte</li> <li>nur ca. <b>40 x 100 mm</b></li> <li>inkl. Befestigungsschrauben</li> </ul> <p>Ohne deutsches Prüfzeichen - Verkauf und Nutzung im Geltungsbereich der StVZO (Deutschland) unzulässig (Abgabe nur an außerdeutsche Kunden).</p>	<ul style="list-style-type: none"> <li>for <b>carrier</b></li> <li>for hole distance <b>50 and 80 mm</b></li> <li>additional fixing possibility in the middle</li> <li>only approx. <b>40 x 100 mm</b></li> <li>incl. fastening screws</li> </ul>	  <p>UVP 0,99 €</p>
<b>466409</b> 500 <b>NEW</b>	<ul style="list-style-type: none"> <li>für <b>werkzeuglose Montage</b> an der Sattelstütze</li> <li><b>winkelverstellbarer Gummiband-Universalhalter</b></li> <li>für Ø 22,2 - 31,8 mm</li> <li>Z-Reflektor</li> <li>mit <b>deutschem Prüfzeichen</b></li> <li>Montageverpackung</li> </ul>	<ul style="list-style-type: none"> <li><b>toolless mounting</b> on seat post</li> <li><b>angle adjustable rubber strap universal bracket</b></li> <li>for Ø 22.2 - 31.8 mm</li> <li>Z-reflector</li> <li>with <b>German approval number</b></li> <li>OEM</li> </ul>	 <p>UVP 0,99 €</p>
<b>466400</b> 800	<ul style="list-style-type: none"> <li>für <b>Schutzblechmontage</b></li> <li>mit <b>deutschem Prüfzeichen</b></li> <li>Ø 41 mm</li> <li>mit Befestigungsschraube</li> </ul>	<ul style="list-style-type: none"> <li>for <b>mudguard installation</b></li> <li>with <b>German approval number</b></li> <li>Ø 41 mm</li> <li>with fastening screw</li> </ul>	 <p>UVP 0,99 €</p>
<b>466619</b> 100 Set	<ul style="list-style-type: none"> <li>mit <b>deutschem Prüfzeichen</b></li> <li>im PE-Beutel, bestehend aus</li> <li>- <b>4 Speichenreflektoren</b> (Art. 466603): 60 mm Klemmweite, Nirosta-Klammern</li> <li>- <b>1 Reflektor vorne</b> (Art. 460800): Winkel verstellbar</li> <li>- <b>1 Reflektor hinten</b> (Art. 460801): Winkel verstellbar</li> </ul>	<ul style="list-style-type: none"> <li>with <b>German approval number</b></li> <li>in closed PE-bag, includes</li> <li>- <b>4 spoke reflectors</b> (art. 466603): 60 mm clamping width, stainless steel clamps</li> <li>- <b>1 reflector front</b> (art. 460800): angle adjustable</li> <li>- <b>1 reflector rear</b> (art. 460801): angle adjustable</li> </ul>	 <p>UVP 4,90 €</p>
<b>466100</b> 1.000/10 <b>466101</b> <b>466095</b> 1.000/5	<b>REFLEKTORHALTER</b> <ul style="list-style-type: none"> <li>für Montage an der Sattelstütze, Sitzrohr, Vorbau, ...</li> <li>Lochabstand: 20 mm</li> <li>Montageverpackung</li> </ul>	<b>REFLECTOR BRACKET</b> <ul style="list-style-type: none"> <li>for mounting at seat post, seat tube, stem, ...</li> <li>hole distance: 20 mm</li> <li>OEM</li> </ul>	 <p>UVP 0,50 €</p>
<b>460745</b> 500	Low-profile-Halter, verzinkt	low profile bracket, zinc-plated	 <p>UVP 0,50 €</p>

# NABENDYNAMOS HUB DYNAMOS

ART.-NR.	BESCHREIBUNG	DESCRIPTION	DYNAMO → WECHSELSTROM/AC
	<p><b>NABENDYNAMO ›SHUTTER‹</b></p> <ul style="list-style-type: none"> <li>Aluminium</li> <li>schwarz eloxiert</li> <li><b>klein und leicht, nur 390 g</b></li> <li>sehr <b>leicht laufend</b></li> <li><b>Wirkungsgrad 72 %</b> bei 15 km/h</li> <li>mit <b>2 Industriekugellagern</b></li> <li>Einbaumaß: 100 mm</li> <li>32 Loch (andere Lochzahl auf Anfrage)</li> <li>6 V/3 W</li> <li>mit Hohlachse für <b>Schnellspanner</b></li> <li>mit <b>deutschem Prüfzeichen</b></li> <li>geeignet für 26" - 28"</li> <li>mit <b>Flachstecker</b> für Dynamokabel</li> <li>Montageverpackung</li> </ul>	<p><b>HUB DYNAMO ›SHUTTER‹</b></p> <ul style="list-style-type: none"> <li>aluminium</li> <li>black anodized</li> <li><b>small and light, only 390 g</b></li> <li>very <b>smooth running</b></li> <li><b>efficiency 72 %</b> at 15 km/h</li> <li>with <b>2 sealed bearings</b></li> <li>OLD: 100 mm</li> <li>32 hole (other number of holes on request)</li> <li>6 V/3 W</li> <li>with hollow axle for <b>QR</b></li> <li>with <b>German approval number</b></li> <li>suitable for 26" - 28"</li> <li>with <b>flat plug</b> for dynamo cable</li> <li>OEM</li> </ul>	<p><b>390 g</b></p>     <p>für Scheibenbremsaufnahme/ for disc brake mounting</p>  
<p><b>460020</b> 25</p>	<p>für <b>V-Bremse</b></p>	<p>for <b>V-brake</b> UVP 129,90 €</p>	
<p><b>460025</b> 36</p>	<p>für <b>Scheibenbremse</b></p>	<p>for <b>disc brake</b> UVP 156,00 €</p>	
 <p>700C wheel StVZO voltage output test</p>	 <p>additional pedal power input when light on</p>	 <p>additional pedal power input when light off</p> <p>— 460020/25 — DH-3N80 - - - StVZO</p>	
<p><b>NABENDYNAMO</b></p> <ul style="list-style-type: none"> <li>Aluminium</li> <li>Einbaumaß: 100 mm</li> <li>36 Loch</li> <li>6 V/3 W</li> <li>mit <b>deutschem Prüfzeichen</b></li> <li>mit Verbindungsstecker (Art. 460036), passend auch für Shimano (kein original Shimano Ersatzteil)</li> <li>geeignet für 16" - 28"</li> </ul> <p>mit Festachse</p> <ul style="list-style-type: none"> <li><b>460063</b> schwarz</li> <li><b>460055</b> silber</li> <li><b>460056</b> silber, mit Schnellspanner</li> <li><b>460057</b> silber, für <b>Scheibenbremse</b>, mit Festachse</li> </ul>	<p><b>HUB DYNAMO</b></p> <ul style="list-style-type: none"> <li>aluminium</li> <li>OLD: 100 mm</li> <li>36 hole</li> <li>6 V/3 W</li> <li>with <b>German approval number</b></li> <li>with connector (art. 460036), also suitable for Shimano (no original Shimano spare part)</li> <li>suitable for 16" - 28"</li> </ul> <p>with solid axle</p> <ul style="list-style-type: none"> <li>black</li> <li>silver</li> <li>silver, with quick release</li> <li>silver, for <b>disc brake</b>, with solid axle</li> </ul>	   <p><b>DISC BRAKE</b></p>  	
<p><b>NEW</b></p>		<p>UVP 39,90 €</p> <p>UVP 39,90 €</p> <p>UVP 41,90 €</p>	
<p>12</p>		<p>UVP 43,90 €</p>	
<p><b>460036</b> 500/100</p>	<p><b>Stecker</b> für Nabendynamos, z. B. für Art. 460055,6,7 <b>Shimano</b> (kein original Shimano Ersatzteil), ...</p>	<p><b>connector</b> for hub dynamos, e. g. art. 460055,6,7 <b>Shimano</b> (no original Shimano spare part), ...</p> <p>UVP 0,99 €</p>	





ART.-NR.	BESCHREIBUNG	DESCRIPTION	
  <b>461046</b>  <b>461047</b>	<b>ALUMINIUM-DYNAMO</b> <ul style="list-style-type: none"> <li>• 6V/3W</li> <li>• Gehäuse aus <b>Aluminium</b></li> <li>• mit <b>Metallreibrolle</b></li> </ul> rechts, Montageverpackung  links, Montageverpackung	<b>ALUMINIUM DYNAMO</b> <ul style="list-style-type: none"> <li>• 6V/3W</li> <li>• body made of <b>aluminium</b></li> <li>• with <b>metal roll</b></li> </ul> right, OEM  left, OEM	
<b>461044</b>  <b>461045</b> 100	rechts, im Anlun Einzelkarton  links, im Anlun Einzelkarton  <small>Ohne deutsches Prüfzeichen - Verkauf und Nutzung im Geltungsbereich der StVZO (Deutschland) unzulässig (Abgabe nur an außerdeutsche Kunden).</small>	right, in Anlun box  left, in Anlun box  UVP 5,90 €	
<b>460240</b>  <b>460241</b> 100	<b>AERO-DYNAMO</b> <ul style="list-style-type: none"> <li>• 6V/3W</li> <li>• Gehäuse aus fast <b>unzerbrechlichem Spezialnylon</b></li> <li>• mit <b>Doppelanschluss (+ und -)</b></li> <li>• <b>leichter Lauf</b> und <b>längere Lebensdauer</b> durch <b>verbesserte Lagerung</b></li> <li>• mit <b>Überspannungsschutz</b></li> <li>• mit <b>deutschem Prüfzeichen</b></li> <li>• im Anlun Einzelkarton</li> </ul> rechts  links	<b>AERO DYNAMO</b> <ul style="list-style-type: none"> <li>• 6V/3W</li> <li>• body made of almost <b>unbreakable special nylon</b></li> <li>• with <b>double connection (+ and -)</b></li> <li>• <b>smooth running</b> and <b>longer duration of life</b> because of <b>improved pushing</b></li> <li>• with <b>overvoltage protection</b></li> <li>• with <b>German approval number</b></li> <li>• in Anlun box</li> </ul> right  left	 <div data-bbox="1002 1303 1177 1355" style="border: 1px solid blue; padding: 2px; display: inline-block;">DOUBLE-CONNECTION</div>
<b>460854</b> 500/100	Ersatz-Dynamoreibrolle	replacement dynamo roll cover  UVP 0,90 €	
<b>461027</b>  <b>461028</b> 100	<b>DYNAMO</b> <ul style="list-style-type: none"> <li>• 6V/3W</li> <li>• Gehäuse aus <b>schwarzem Kunststoff</b></li> <li>• mit <b>deutschem Prüfzeichen</b></li> <li>• mit <b>Überspannungsschutz</b></li> <li>• mit <b>Doppelanschluss (+ und -)</b></li> <li>• Montageverpackung</li> </ul> rechts  links	<b>DYNAMO</b> <ul style="list-style-type: none"> <li>• 6V/3W</li> <li>• body made of <b>black plastic</b></li> <li>• with <b>German approval number</b></li> <li>• with <b>overvoltage protection</b></li> <li>• with <b>double connection (+ and -)</b></li> <li>• OEM</li> </ul> right  left	 <div data-bbox="1002 2056 1177 2107" style="border: 1px solid blue; padding: 2px; display: inline-block;">DOUBLE-CONNECTION</div>

# BIRNCHEN / BATTERIEN BULBS / BATTERIES

ART.-NR. 	BESCHREIBUNG	DESCRIPTION	
<p><b>630070</b> 1.000/200/10</p> <p><b>630075</b> 6.000/50</p>	<p><b>BIRNCHEN</b> für <b>Fahrrad-Rücklicht</b></p> <ul style="list-style-type: none"> <li>• <b>6 Volt / 0,6 Watt</b> (0,1 A)</li> <li>• mit Schraubsockel E 10</li> <li>• mit <b>deutschem Prüfzeichen</b></li> </ul> <p>10er Packung</p> <p>50er Packung, ohne Prüfnummer</p>	<p><b>BULBS</b> for <b>bicycle rear light</b></p> <ul style="list-style-type: none"> <li>• <b>6 Volt / 0.6 Watt</b> (0.1 A)</li> <li>• with screw base E10</li> <li>• with <b>German approval number</b></li> </ul> <p>10 pcs in a box UVP 49,90 €/100</p> <p>50 pcs in a box, w/o approval number UVP 39,90 €/100</p>	
<p><b>630085</b> 4.000/100</p>	<p>für <b>Fahrradscheinwerfer</b></p> <ul style="list-style-type: none"> <li>• <b>6 Volt / 2,4 Watt</b> (0,4 A)</li> <li>• mit Schraubsockel EP 10</li> <li>• 50er Packung, ohne Prüfnummer</li> </ul>	<p>for <b>bicycle head lamps</b></p> <ul style="list-style-type: none"> <li>• <b>6 Volt / 2.4 Watt</b> (0.4 A)</li> <li>• with screw base EP 10</li> <li>• 50 pcs in a box, w/o approval number UVP 39,90 €/100</li> </ul>	
<p><b>636411</b> 1.000/200/10</p>	<p><b>BIRNCHEN ›HALOGEN‹</b></p> <ul style="list-style-type: none"> <li>• für <b>Fahrradscheinwerfer</b></li> <li>• <b>Halogen</b></li> <li>• <b>6 Volt / 2,4 Watt</b> (0,4 A)</li> <li>• mit Schraubsockel PX 13,5 S</li> <li>• mit <b>deutschem Prüfzeichen</b></li> <li>• 10er Packung</li> </ul>	<p><b>BULBS ›HALOGEN‹</b></p> <ul style="list-style-type: none"> <li>• for <b>bicycle head lamps</b></li> <li>• <b>Halogen</b></li> <li>• <b>6 Volt / 2.4 Watt</b> (0.4 A)</li> <li>• with plug base PX 13.5 S</li> <li>• with <b>German approval number</b></li> <li>• 10 pcs in a box UVP 3,90 €</li> </ul>	
<p><b>640825</b> 50/10 set</p>	<p><b>X-POWER BATTERIEN</b></p> <ul style="list-style-type: none"> <li>• Micro, AM-4, AAA, LR-3</li> <li>• <b>sehr hochwertige</b> Alkaline-Batterien</li> <li>• 0 % Kadmium, 0 % Quecksilber</li> <li>• 4 Stück in Blisterverpackung</li> </ul>	<p><b>X-POWER BATTERIES</b></p> <ul style="list-style-type: none"> <li>• Micro, AM-4, AAA, LR-3</li> <li>• <b>very high quality</b> alkaline batteries</li> <li>• 0 % cadmium, 0 % mercury</li> <li>• 4 pcs in blister packaging</li> </ul> <p>UVP 2,90 € / set</p>	<p><b>ALKALINE</b> <b>TOP QUALITY</b></p> 
<p><b>640821</b> 100 set</p> <p><b>640822</b> 100 set</p>	<p><b>ALKALINE-BATTERIEN</b></p> <ul style="list-style-type: none"> <li>• Micro, AM-4, AAA, LR3</li> <li>• 4 Stück in Blisterverpackung</li> </ul> <p>• Mignon, AM-3, AA, LR6</p> <ul style="list-style-type: none"> <li>• 4 Stück in Blisterverpackung</li> </ul>	<p><b>ALKALINE BATTERIES</b></p> <ul style="list-style-type: none"> <li>• Micro, AM-4, AAA, LR3</li> <li>• 4 pcs in blister packaging</li> </ul> <p>• Mignon, AM-3, AA, LR6</p> <ul style="list-style-type: none"> <li>• 4 pcs in blister packaging</li> </ul> <p>UVP 2,50 € / set</p> <p>UVP 2,90 € / set</p>	<p><b>ALKALINE</b></p> 
<p><b>640814</b> 20 set</p> <p><b>640816</b> 400/20 set</p>	<p><b>BATTERIEN FÜR COMPUTER, BLINKLICHTER, ...</b></p> <ul style="list-style-type: none"> <li>• hochwertige <b>Lithium</b>-Batterie <b>CR2032</b></li> <li>• 3 V / 220 mAh</li> <li>• made in Japan</li> <li>• 5 Stück auf <b>Abreiß-Eurolochkarte</b></li> </ul> <p>• <b>Lithium</b>-Batterie <b>CR2032</b></p> <ul style="list-style-type: none"> <li>• 3 V / 210 mAh</li> <li>• 5 Stück auf Ventura <b>Abreiß-Eurolochkarte</b></li> </ul>	<p><b>BATTERIES FOR COMPUTER, FLASHLIGHTS, ...</b></p> <ul style="list-style-type: none"> <li>• high quality <b>Lithium</b> battery <b>CR2032</b></li> <li>• 3 V / 220 mAh</li> <li>• made in Japan</li> <li>• 5 pcs on <b>breakaway eurohole card</b></li> </ul> <p>UVP 7,90 € / set</p> <p>• <b>Lithium</b> battery <b>CR2032</b></p> <ul style="list-style-type: none"> <li>• 3 V / 210 mAh</li> <li>• 5 pcs on Ventura <b>breakaway eurohole card</b></li> </ul> <p>UVP 3,90 € / set</p>	<p><b>MAXELL</b> <b>MADE IN JAPAN</b></p> 
<p><b>640828</b> 360/20 set</p>	<p>• <b>Alkaline</b>-Batterie <b>LR44</b></p> <ul style="list-style-type: none"> <li>• 1,5 V / 110 mAh</li> <li>• 10 Stück in perforierter Blisterverpackung</li> </ul>	<p>• <b>Alkaline</b> battery <b>LR44</b></p> <ul style="list-style-type: none"> <li>• 1.5 V / 110 mAh</li> <li>• 10 pieces in perforated blister packaging</li> </ul> <p>UVP 12,90 € / set</p>	<p><b>MAXELL</b> <b>ALKALINE</b></p> 





# LOCKS

ART.-NR.	BESCHREIBUNG	DESCRIPTION	
	<p><b>SEIEN SIE SICH SICHER, BEI DIESER SICHERHEIT!</b></p> <p>Unsere <b>neuen, hochwertigen Schlösser</b> punkten sowohl mit <b>extra</b> starken und gehärteten Stahlkernen, als auch mit <b>top-verarbeiteten Schließköpfen</b>. Hier schreckt nicht nur die Optik jeden Dieb ab!</p>	<p><b>BE SURE, WITH THIS SAFETY!</b></p> <p>Our <b>new high-class locks</b> score with <b>extra</b> strong and hardened steel cores as well as <b>highly processed lock heads</b>. Not only the visual appearance will frighten off every potential thief!</p>	
<p><b>230950</b></p> <p>10</p>	<p><b>KETTENSCHLOSS ›C 10.9-360‹</b></p> <ul style="list-style-type: none"> <li>• 10 x 10 x 900 mm</li> <li>• <b>besonders widerstandsfähig</b> durch <b>gehärtete quadratische Kettenglieder</b> und <b>robusten Schließzylinder</b></li> <li>• viele verschiedene <b>computer-designte</b> Schlüsselvarianten</li> <li>• <b>360° drehbarer Verschlusskopf</b></li> <li>• mit Staubschutzkappe</li> <li>• mit Textilüberzug</li> <li>• mit M-Wave Banderole</li> </ul>	<p><b>CHAIN LOCK ›C 10.9-360‹</b></p> <ul style="list-style-type: none"> <li>• 10 x 10 x 900 mm</li> <li>• <b>very robust</b> because of <b>hardened square chain links</b> and <b>robust cylinder lock</b></li> <li>• many different <b>computer-designed</b> key variants</li> <li>• <b>360° turnable lock head</b></li> <li>• with dust cap</li> <li>• with textile cover</li> <li>• with M-Wave banderole</li> </ul>	<p><b>10 x 10 x 900</b></p>     <p>UVP 49,90 €</p>
<p><b>230920</b></p> <p>10/5</p>	<p><b>SPIRALKABELSCHLOSS ›S 20.18‹</b></p> <ul style="list-style-type: none"> <li>• Ø 20 x 1.800 mm</li> <li>• <b>extra dickes</b>, geflochtenes Kabel</li> <li>• <b>360° drehbarer Verschlusskopf</b></li> <li>• dunkel-transparenter Überzug</li> <li>• viele verschiedene <b>computer-designte</b> Schlüsselvarianten</li> <li>• universeller Clip-on-Halter für Sattelstütze und Rahmenrohr Ø 22,2 - 43 mm</li> <li>• mit Staubschutzkappe</li> <li>• auf M-Wave Eurolochkarte</li> </ul>	<p><b>SPIRAL CABLE LOCK ›S 20.18‹</b></p> <ul style="list-style-type: none"> <li>• Ø 20 x 1,800 mm</li> <li>• <b>extra thick</b>, braided cable</li> <li>• <b>360° turnable lock head</b></li> <li>• dark transparent cover</li> <li>• many different <b>computer-designed</b> key variants</li> <li>• universal clip-on bracket for seat post and frame tube Ø 22.2 - 43 mm</li> <li>• with dust cap</li> <li>• on M-Wave eurohole card</li> </ul>	<p><b>20 x 1.800</b></p>   <p>UVP 30,90 €</p>
<p><b>230910</b></p> <p>10/5</p>	<p><b>SPIRALKABELSCHLOSS ›DS 20.18‹</b></p> <ul style="list-style-type: none"> <li>• Ø 20 x 1.800 mm</li> <li>• <b>extra dickes</b>, geflochtenes Kabel</li> <li>• dunkel-transparenter Überzug</li> <li>• <b>verstellbarer, persönlicher Sicherheitscode</b> aus <b>5 Zahlen</b></li> <li>• auf M-Wave Eurolochkarte</li> </ul>	<p><b>SPIRAL CABLE LOCK ›DS 20.18‹</b></p> <ul style="list-style-type: none"> <li>• Ø 20 x 1,800 mm</li> <li>• <b>extra thick</b>, braided cable</li> <li>• dark transparent cover</li> <li>• <b>changeable, individual security code</b> with <b>5 digits</b></li> <li>• on M-Wave eurohole card</li> </ul>	<p><b>5x</b></p>   <p>UVP 34,90 €</p>

ART.-NR.	BESCHREIBUNG	DESCRIPTION	
<b>REFLEX</b>		<b>REFLEX</b>	
<b>REFLEX</b>		<b>REFLEX</b>	
<b>230961</b> 40/10	<b>SPIRALKABELSCHLOSS ›S 10.18 ILLU‹</b> <ul style="list-style-type: none"> <li>• Ø 10 x 1.800 mm</li> <li>• mit <b>Reflexstreifen</b></li> <li>• dunkel-transparenter Überzug</li> <li>• Clip-on-Halter (Art. 233849) für Sattelstütze und Rahmenrohr, beidseitig einführbar</li> <li>• mit <b>Staubschutzkappe</b></li> <li>• <b>automatische Verriegelung</b></li> <li>• auf M-Wave Eurolochkarte</li> </ul>	<b>SPIRAL CABLE LOCK ›S 10.18 ILLU‹</b> <ul style="list-style-type: none"> <li>• Ø 10 x 1,800 mm</li> <li>• with <b>reflective stripe</b></li> <li>• dark transparent cover</li> <li>• clip-on bracket (art. 233849) for seat post and frame tube, clip-on possibility from both sides</li> <li>• with <b>dust cap</b></li> <li>• <b>automatic locking</b></li> <li>• on M-Wave eurohole card</li> </ul>	<b>10 x 1.800</b> 
<b>230962</b> 40/20	<b>SPIRALKABELSCHLOSS ›DS 10.18 ILLU‹</b> <ul style="list-style-type: none"> <li>• Ø 10 x 1.800 mm</li> <li>• mit <b>Reflexstreifen</b></li> <li>• dunkel-transparenter Überzug</li> <li>• <b>verstellbarer</b>, persönlicher Sicherheitscode</li> <li>• Clip-on-Halter (Art. 233849) für Sattelstütze oder Rahmenrohr, beidseitig einführbar</li> <li>• auf M-Wave Eurolochkarte</li> </ul>	<b>SPIRAL CABLE LOCK ›DS 10.18 ILLU‹</b> <ul style="list-style-type: none"> <li>• Ø 10 x 1,800 mm</li> <li>• with <b>reflective stripe</b></li> <li>• dark transparent cover</li> <li>• <b>changeable</b>, individual security code</li> <li>• clip-on bracket (art. 233849) for seat post or frame tube, clip-on possibility from both sides</li> <li>• on M-Wave eurohole card</li> </ul>	<b>10 x 1.800</b> 
<b>230960</b> 60/10	<b>KABELSCHLOSS ›C 15.8 ILLU‹</b> <ul style="list-style-type: none"> <li>• Ø 15 x 800 mm</li> <li>• geflochtenes Kabel</li> <li>• mit <b>Reflexstreifen</b></li> <li>• dunkel-transparenter Überzug</li> <li>• <b>automatische Verriegelung</b></li> <li>• auf M-Wave Eurolochkarte</li> </ul>	<b>CABLE LOCK ›C 15.8 ILLU‹</b> <ul style="list-style-type: none"> <li>• Ø 15 x 800 mm</li> <li>• braided cable</li> <li>• with <b>reflective stripe</b></li> <li>• dark transparent cover</li> <li>• <b>automatic locking</b></li> <li>• on M-Wave eurohole card</li> </ul>	<b>15 x 800</b> 
<b>230963</b> 12/6	<b>KETTENSCHLOSS ›C 6.8,5 ILLU‹</b> <ul style="list-style-type: none"> <li>• Ø 6 x 850 mm</li> <li>• Textilüberzug mit <b>Reflexstreifen</b></li> <li>• <b>automatische Verriegelung</b></li> <li>• mit Staubschutzkappe</li> <li>• <b>computer-designte</b> Schlüssel</li> <li>• mit M-Wave Banderole</li> </ul>	<b>CHAIN LOCK ›C 6.8,5 ILLU‹</b> <ul style="list-style-type: none"> <li>• Ø 6 x 850 mm</li> <li>• textile cover with <b>reflective stripe</b></li> <li>• <b>automatic locking</b></li> <li>• with dust cap</li> <li>• <b>computer-designed</b> keys</li> <li>• with M-Wave banderole</li> </ul>	<b>6 x 850</b> 
<b>230964</b> 12/6	<b>ZAHLEN-KETTENSCHLOSS ›D 6.8,5 ILLU‹</b> <ul style="list-style-type: none"> <li>• Ø 6 x 850 mm</li> <li>• Textilüberzug mit <b>Reflexstreifen</b></li> <li>• mit <b>5 Zahlenscheiben</b></li> <li>• mit <b>verstellbarem</b>, persönlichem Sicherheitscode</li> <li>• mit M-Wave Banderole</li> </ul>	<b>COMBINATION CHAIN LOCK ›D 6.8,5 ILLU‹</b> <ul style="list-style-type: none"> <li>• Ø 6 x 850 mm</li> <li>• textile cover with <b>reflective stripe</b></li> <li>• with <b>5 digits</b></li> <li>• with <b>changeable</b>, individual security codes</li> <li>• with M-Wave banderole</li> </ul>	<b>6 x 850</b> 

UVP 8,90 €

UVP 8,90 €

UVP 6,90 €





















UVP 14,90 €

UVP 14,90 €



ART.-NR.	BESCHREIBUNG	DESCRIPTION	
<b>HEXAGONALSCHLÖSSER</b>		<b>HEXAGONAL LOCKS</b>	
<b>233853</b> 24	<b>SPIRALKABELSCHLOSS ›DS 12.18‹</b> <ul style="list-style-type: none"> <li>• Ø 12 x 1.800 mm</li> <li>• mattschwarz transparenter, <b>hexagonaler</b> Überzug</li> <li>• <b>verstellbarer, persönlicher Sicherheitscode</b></li> <li>• universeller Clip-on-Halter für Sattelstütze, Rahmenrohr und für Sattelklemmbolzen</li> <li>• auf M-Wave Eurolochkarte</li> </ul>	<b>SPIRAL CABLE LOCK ›DS 12.18‹</b> <ul style="list-style-type: none"> <li>• Ø 12 x 1,800 mm</li> <li>• matt black transparent, <b>hexagonal</b> cover</li> <li>• <b>changeable, individual security code</b></li> <li>• universal clip-on bracket for seat post, frame tube and for seat pin</li> <li>• on M-Wave eurohole card</li> </ul>	<div style="text-align: right;"><b>12 x 1.800</b></div>  <p style="text-align: right;">UVP 13,90 €</p>
<b>233817</b> 24/12	<b>SPIRALKABELSCHLOSS ›S 12.18‹</b> <ul style="list-style-type: none"> <li>• Ø 12 x 1.800 mm</li> <li>• mattschwarz transparenter, <b>hexagonaler</b> Überzug</li> <li>• viele verschiedene <b>computer-designte</b> Schlüsselvarianten</li> <li>• Clip-on-Halter für Sattelstütze und Rahmenrohr zur direkten Befestigung am Schlosskopf</li> <li>• auf M-Wave Eurolochkarte</li> </ul>	<b>SPIRAL CABLE LOCK ›S 12.18‹</b> <ul style="list-style-type: none"> <li>• Ø 12 x 1,800 mm</li> <li>• matt black transparent, <b>hexagonal</b> cover</li> <li>• many different <b>computer-designed</b> key variants</li> <li>• clip-on bracket for seat post and frame tube for direct mounting at the lock head</li> <li>• on M-Wave eurohole card</li> </ul>	<div style="text-align: right;"><b>12 x 1.800</b></div>  <p style="text-align: right;">UVP 11,90 €</p>
<b>SPIRALKABELSCHLÖSSER</b>		<b>SPIRAL CABLE LOCKS</b>	
	<b>SPIRALKABELSCHLOSS ›DS 12.10 S‹</b> <ul style="list-style-type: none"> <li>• Ø 12 x 1.000 mm</li> <li>• mit <b>Silikonüberzug</b></li> <li>• <b>verstellbarer, persönlicher Sicherheitscode</b></li> <li>• auf M-Wave Eurolochkarte</li> </ul>	<b>SPIRAL CABLE LOCK ›DS 12.10 S‹</b> <ul style="list-style-type: none"> <li>• Ø 12 x 1,000 mm</li> <li>• with <b>silicone cover</b></li> <li>• <b>changeable, individual security code</b></li> <li>• on M-Wave eurohole card</li> </ul>	<div style="text-align: right;"><b>SILICONE</b></div> <div style="text-align: right;"><b>12 x 1.000</b></div>  <p style="text-align: right;">UVP 10,90 €</p>
<b>231060</b>	schwarz	black	
<b>231065</b>	grün	green	
<b>231067</b>	orange	orange	
<b>231068</b>	pink	pink	
<b>231069</b> 60/10	lila	purple	
<b>233855</b> 40/10	<b>SPIRALKABELSCHLOSS ›DS 10.18 L‹</b> <ul style="list-style-type: none"> <li>• Ø 10 x 1.800 mm</li> <li>• dunkel-transparenter Überzug</li> <li>• <b>1 blaue LED zur Beleuchtung der Ziffern</b></li> <li>• wahlweise zu öffnen durch <b>verstellbaren, persönlichen Sicherheitscode</b> oder durch <b>computer-designte Schlüssel</b></li> <li>• universeller Clip-on-Halter</li> <li>• inkl. Batterien (2 x CR 1220)</li> <li>• auf M-Wave Eurolochkarte</li> </ul>	<b>SPIRAL CABLE LOCK ›DS 10.18 L‹</b> <ul style="list-style-type: none"> <li>• Ø 10 x 1,800 mm</li> <li>• dark transparent cover</li> <li>• <b>1 blue LED for illumination of the digits</b></li> <li>• can be opened by <b>changeable, individual security code</b> or by <b>computer-designed keys</b></li> <li>• universal clip-on bracket</li> <li>• incl. batteries (2 x CR 1220)</li> <li>• on M-Wave eurohole card</li> </ul>	<div style="text-align: right;"><b>10 x 1.800</b></div>  <p style="text-align: right;">UVP 14,90 €</p>

ART.-NR.	BESCHREIBUNG	DESCRIPTION	
	<b>SPIRALKABELSCHLOSS ›S 10.18‹</b>	<b>SPIRAL CABLE LOCK ›S 10.18‹</b>	<b>10 x 1.800</b>
	<ul style="list-style-type: none"> <li>• Ø 10 x 1.800 mm</li> <li>• Clip-on-Halter (Art. 233849) für Sattelstütze und Rahmenrohr, beidseitig einführbar</li> <li>• mit <b>Staubschutzkappe</b></li> <li>• auf M-Wave Eurolochkarte</li> </ul>	<ul style="list-style-type: none"> <li>• Ø 10 x 1,800 mm</li> <li>• clip-on bracket (art. 233849) for seat post and frame tube, clip-on possibility from both sides</li> <li>• with <b>dust cap</b></li> <li>• on M-Wave eurohole card</li> </ul>	
<b>230961</b> 40/10	dunkel-transparenter Überzug, mit <b>Reflexstreifen</b>	dark transparent cover, with <b>reflective stripe</b>	UVP 8,90 €
<b>233840</b>	dunkel-transparent	dark transparent	
<b>233862</b>	weiß	white	
<b>233863</b>	rot	red	
<b>233864</b>	blau	blue	
<b>233865</b>	grün	green	
<b>233866</b>	gelb	yellow	
<b>233867</b>	orange	orange	
<b>233868</b> 40/10	pink	pink	
<b>233704</b> 60/10	<b>SPIRALKABELSCHLOSS</b>	<b>SPIRAL CABLE LOCK</b>	
	<ul style="list-style-type: none"> <li>• Ø 10 x 1.800 mm</li> <li>• mit <b>2 Haltern</b>: Universalhalter für Sattelstütze oder Rahmenrohr und für Sattelklemmbolzen</li> <li>• schwarzer Überzug</li> <li>• Montageverpackung</li> </ul>	<ul style="list-style-type: none"> <li>• Ø 10 x 1,800 mm</li> <li>• with <b>2 brackets</b>: universal bracket for seat post or frame tube and for seat pin</li> <li>• black cover</li> <li>• OEM</li> </ul>	
			UVP 6,90 €
	<b>SPIRALKABELSCHLOSS ›S 8.15 S‹</b>	<b>SPIRAL CABLE LOCK ›S 8.15 S‹</b>	<b>SILICONE</b> <b>8 x 1.500</b>
	<ul style="list-style-type: none"> <li>• Ø 8 x 1.500 mm</li> <li>• mit <b>Silikonüberzug</b></li> <li>• viele verschiedene <b>computer-designte</b> Schlüsselvarianten</li> <li>• auf M-Wave Eurolochkarte</li> </ul>	<ul style="list-style-type: none"> <li>• Ø 8 x 1,500 mm</li> <li>• with <b>silicone cover</b></li> <li>• many different <b>computer-designed</b> key variants</li> <li>• on M-Wave eurohole card</li> </ul>	
<b>231010</b>	schwarz	black	UVP 9,90 €
<b>231015</b>	grün	green	
<b>231017</b>	orange	orange	
<b>231018</b>	pink	pink	
<b>231019</b> 60/10	lila	purple	
	<b>SPIRALKABELSCHLOSS</b>	<b>SPIRAL CABLE LOCK</b>	<b>10 x 1.800</b>
	<ul style="list-style-type: none"> <li>• dunkel-transparenter Überzug</li> <li>• <b>verstellbarer</b>, persönlicher Sicherheitscode</li> <li>• Clip-on-Halter (Art. 233849) für Sattelstütze oder Rahmenrohr, beidseitig einführbar</li> <li>• auf M-Wave Eurolochkarte</li> </ul>	<ul style="list-style-type: none"> <li>• dark transparent cover</li> <li>• <b>changeable</b>, individual security code</li> <li>• clip-on bracket (art. 233849) for seat post or frame tube, clip-on possibility from both sides</li> <li>• on M-Wave eurohole card</li> </ul>	
<b>230962</b> 40/20	›DS 10.18 ILLU‹	›DS 10.18 ILLU‹	UVP 8,90 €
	<ul style="list-style-type: none"> <li>• Ø 10 x 1.800 mm</li> <li>• mit <b>Reflexstreifen</b></li> </ul>	<ul style="list-style-type: none"> <li>• Ø 10 x 1,800 mm</li> <li>• with <b>reflective stripe</b></li> </ul>	
	<b>›DS 8.15‹</b>	<b>›DS 8.15‹</b>	<b>8 x 1.500</b>
<b>230170</b> 60/10	Ø 8 x 1.500 mm	Ø 8 x 1,500 mm	UVP 7,90 €

ART.-NR. 	BESCHREIBUNG	DESCRIPTION	
<b>233830</b> 60/10	<b>SPIRALKABELSCHLOSS ›S 8.15‹</b> <ul style="list-style-type: none"> <li>• Ø 8 x 1.500 mm</li> <li>• dunkel-transparenter Überzug</li> <li>• Clip-on-Halter (Art. 233849) für Sattelstütze und Rahmenrohr, beidseitig einführbar</li> <li>• mit <b>Staubschutzkappe</b></li> <li>• auf M-Wave Eurolochkarte</li> </ul>	<b>SPIRAL CABLE LOCK ›S 8.15‹</b> <ul style="list-style-type: none"> <li>• Ø 8 x 1,500 mm</li> <li>• dark transparent cover</li> <li>• clip-on bracket (art. 233849) for seat post and frame tube, clip-on possibility from both sides</li> <li>• with <b>dust cap</b></li> <li>• on M-Wave eurohole card</li> </ul> <p style="text-align: right;">UVP 5,90 €</p>	<div style="text-align: right; border: 1px solid black; padding: 2px; width: fit-content; margin: 0 auto;"><b>8 x 1.500</b></div>  
<b>233775</b> 60/10  <b>233778</b> 60/12	<b>SPIRALKABELSCHLOSS</b> <ul style="list-style-type: none"> <li>• Ø 8 x 1.500 mm</li> <li>• mit Halter für Sattelklemmbolzen</li> <li>• Montageverpackung</li> </ul> <p>schwarz</p> <p>farbig sortiert</p>	<b>SPIRAL CABLE LOCK</b> <ul style="list-style-type: none"> <li>• Ø 8 x 1,500 mm</li> <li>• with bracket for seat pin</li> <li>• OEM</li> </ul> <p>black</p> <p>assorted colours</p> <p style="text-align: right;">UVP 3,90 €</p>	 <div style="display: flex; flex-wrap: wrap; justify-content: space-around;">        </div>
<b>233822</b> 60/10	<b>SPIRALKABELSCHLOSS ›S 6.10‹</b> <ul style="list-style-type: none"> <li>• Ø 6 x 1.000 mm</li> <li>• dunkel-transparenter Überzug</li> <li>• Clip-on-Halter (Art. 233849) für Sattelstütze und Rahmenrohr, beidseitig einführbar</li> <li>• auf M-Wave Eurolochkarte</li> </ul>	<b>SPIRAL CABLE LOCK ›S 6.10‹</b> <ul style="list-style-type: none"> <li>• Ø 6 x 1,000 mm</li> <li>• dark transparent cover</li> <li>• clip-on bracket (art. 233849) for seat post and frame tube, clip-on possibility from both sides</li> <li>• on M-Wave eurohole card</li> </ul> <p style="text-align: right;">UVP 3,90 €</p>	<div style="text-align: right; border: 1px solid black; padding: 2px; width: fit-content; margin: 0 auto;"><b>6 x 1.000</b></div>  
<b>233825</b>  <b>233828</b> 120/12	<b>SPIRALKABELSCHLOSS</b> <ul style="list-style-type: none"> <li>• Ø 6 x 1.000 mm</li> <li>• mit Halter für Sattelklemmbolzen</li> <li>• Montageverpackung</li> </ul> <p>schwarz</p> <p>farbig sortiert</p>	<b>SPIRAL CABLE LOCK</b> <ul style="list-style-type: none"> <li>• Ø 6 x 1,000 mm</li> <li>• with bracket for seat pin</li> <li>• OEM</li> </ul> <p>black</p> <p>assorted colours</p> <p style="text-align: right;">UVP 2,90 €</p>	 <div style="display: flex; flex-wrap: wrap; justify-content: space-around;">       </div>



ART.-NR.	BESCHREIBUNG	DESCRIPTION	
<b>ZAHLENKABELSCHLÖSSER</b>			
<b>DIGIT CABLE LOCKS</b>			
	<b>KABELSCHLOSS ›D 12.9 MEM‹</b>	<b>CABLE LOCK ›D 12.9 MEM‹</b>	<b>SHAPE MEMORY</b> <b>12 x 900</b>
	<ul style="list-style-type: none"> <li>• Ø 12 x 900 mm</li> <li>• flexibles TPE-Kabel – lässt sich in beliebige Formen biegen und hält die Form</li> <li>• verstellbarer, persönlicher Sicherheitscode</li> <li>• auf M-Wave Eurolochkarte</li> </ul>	<ul style="list-style-type: none"> <li>• Ø 12 x 900 mm</li> <li>• flexible TPE cable – can be put into any shape and keeps the shape</li> <li>• changeable, individual security code</li> <li>• on M-Wave eurohole card</li> </ul>	    
<b>231127</b>	orange	orange	
<b>231125</b>	grün	green	
<b>231128</b>	pink	pink	
20			UVP 9,90 €
	<b>KABELSCHLOSS ›DS 12.6,5 S‹</b>	<b>CABLE LOCK ›DS 12.6,5 S‹</b>	<b>SILICONE TOUCH</b> <b>12 x 650</b>
	<ul style="list-style-type: none"> <li>• Ø 12 x 650 mm</li> <li>• mit silikonähnlichem Überzug</li> <li>• verstellbarer, persönlicher Sicherheitscode</li> <li>• auf M-Wave Eurolochkarte</li> </ul>	<ul style="list-style-type: none"> <li>• Ø 12 x 650 mm</li> <li>• with silicone like cover</li> <li>• changeable, individual security code</li> <li>• on M-Wave eurohole card</li> </ul>	         
<b>231050</b>	schwarz	black	
<b>231052</b>	weiß	white	
<b>231053</b>	rot	red	
<b>231054</b>	blau	blue	
<b>231055</b>	grün	green	
<b>231057</b>	orange	orange	
<b>231058</b>	pink	pink	
<b>231059</b>	lila	purple	
60/10			UVP 7,90 €
<b>230180</b>	<b>KABELSCHLOSS ›D 12.6‹</b>	<b>CABLE LOCK ›D 12.6‹</b>	<b>12 x 600</b>
60/10	<ul style="list-style-type: none"> <li>• Ø 12 x 600 mm</li> <li>• geflochtenes Kabel</li> <li>• dunkel-transparenter Überzug</li> <li>• verstellbarer, persönlicher Sicherheitscode</li> <li>• mit Clip-on-Halter für Sattelstütze oder Rahmenrohr</li> <li>• beidseitig einführbar</li> <li>• auf M-Wave Eurolochkarte</li> </ul>	<ul style="list-style-type: none"> <li>• Ø 12 x 600 mm</li> <li>• braided cable</li> <li>• dark transparent cover</li> <li>• changeable, individual security code</li> <li>• with clip-on bracket for seat post or frame tube</li> <li>• clip-on possibility from both sides</li> <li>• on M-Wave eurohole card</li> </ul>	  
			UVP 6,90 €
<b>230101</b>	<b>KABELSCHLOSS</b>	<b>CABLE LOCK</b>	<b>8 x 600</b>
120/12	<ul style="list-style-type: none"> <li>• Ø 8 x 600 mm</li> <li>• dunkel-transparenter Überzug</li> <li>• mit 4 Zahlenscheiben</li> <li>• Montageverpackung</li> </ul>	<ul style="list-style-type: none"> <li>• Ø 8 x 600 mm</li> <li>• dark transparent cover</li> <li>• with 4 digits</li> <li>• OEM</li> </ul>	
			UVP 3,90 €
<b>230106</b>	<b>KABELSCHLOSS</b>	<b>CABLE LOCK</b>	<b>12 x 500</b>
	<ul style="list-style-type: none"> <li>• Ø 12 x 500 mm</li> <li>• verchromter Schließkopf</li> <li>• Stahlseil mit Plastiküberzug</li> </ul>	<ul style="list-style-type: none"> <li>• Ø 12 x 500 mm</li> <li>• chromium closing head</li> <li>• steel rope with plastic cover</li> </ul>	      
<b>230108</b>	farbig sortiert	assorted colours	
120/12			UVP 2,90 €

ART.-NR.	BESCHREIBUNG	DESCRIPTION	
<b>KABELSCHLÖSSER</b> <span style="float: right;"><b>CABLE LOCKS</b></span>			
<b>230061</b> 20/10	<b>KABELSCHLOSS ›STYLE 23.10‹</b> <ul style="list-style-type: none"> <li>• (24 x 12) x 1.000 mm</li> <li>• <b>automatische Verriegelung</b></li> <li>• <b>hohe Sicherheit</b> durch geflochtenes Doppelkabel und Einschub-Bolzen-technik</li> <li>• transparenter Überzug</li> <li>• mit <b>Reflexstreifen</b></li> <li>• viele verschiedene computer-designte Schlüsselvarianten</li> <li>• <b>erweiterbar</b> durch Anhängen mehrerer Schlösser</li> <li>• auf M-Wave Eurolochkarte</li> </ul>	<b>CABLE LOCK ›STYLE 23.10‹</b> <ul style="list-style-type: none"> <li>• (24 x 12) x 1,000 mm</li> <li>• <b>automatic locking</b></li> <li>• <b>high security</b> through braided dual wire innercable and special safety pin technology</li> <li>• transparent cover</li> <li>• with <b>reflective stripe</b></li> <li>• many different computer-designed key variants</li> <li>• <b>expandable</b> through adding more locks</li> <li>• on M-Wave eurohole card</li> </ul>	<div style="text-align: right;"><b>(24 x 12) x 1.000</b></div>      <div style="text-align: right;">UVP 25,90 €</div>
<b>230164</b> 60	<b>KABELSCHLOSS MIT REFLEX-ÜBERZUG ›C15-8 ILLU C‹</b> <ul style="list-style-type: none"> <li>• <b>Kabelschloss</b> (Art. 230161)</li> <li>• Ø 15 x 800 mm</li> <li>• <b>geflochtenes Kabel</b></li> <li>• automatische Verriegelung</li> <li>• mit <b>Schlossüberzug</b> (Art. 120999)</li> <li>• <b>360° reflektierend</b></li> <li>• auf M-Wave Eurolochkarte</li> </ul>	<b>CABLE LOCK WITH REFLECTIVE COVER ›C15-8 ILLU C‹</b> <ul style="list-style-type: none"> <li>• <b>cable lock</b> (art. 230161)</li> <li>• Ø 15 x 800 mm</li> <li>• <b>braided design</b></li> <li>• automatic locking</li> <li>• with <b>lock cover</b> (art. 120999)</li> <li>• <b>360° reflective</b></li> <li>• on M-Wave eurohole card</li> </ul>	<div style="text-align: right;"><b>15 x 800</b></div>   <div style="text-align: right;">UVP 8,90 €</div>
<b>231040</b> <b>231045</b> <b>231047</b> <b>231048</b> <b>231049</b> 60/10	<b>KABELSCHLOSS ›S 12.6 S‹</b> <ul style="list-style-type: none"> <li>• Ø 12 x 600 mm</li> <li>• mit <b>Silikonüberzug</b></li> <li>• viele verschiedene <b>computer-designte</b> Schlüsselvarianten</li> <li>• auf M-Wave Eurolochkarte</li> </ul>	<b>CABLE LOCK ›S 12.6 S‹</b> <ul style="list-style-type: none"> <li>• Ø 12 x 600 mm</li> <li>• with <b>silicone cover</b></li> <li>• many different <b>computer-designed</b> key variants</li> <li>• on M-Wave eurohole card</li> </ul>	<div style="text-align: right;"><b>SILICONE</b> <span style="float: right;"><b>12 x 600</b></span></div>    <div style="text-align: right;">UVP 7,90 €</div>
<b>230150</b> 50/10	<b>KABELSCHLOSS ›TWIST LOCK‹</b> <ul style="list-style-type: none"> <li>• Ø 12 x 650 mm</li> <li>• mit <b>drehbarem</b> Schließkopf</li> <li>• <b>automatische Verriegelung</b></li> <li>• dunkel-transparenter Überzug</li> <li>• <b>geflochtenes Kabel</b></li> <li>• mit Staubschutzkappe</li> <li>• Montageverpackung</li> </ul>	<b>CABLE LOCK ›TWIST LOCK‹</b> <ul style="list-style-type: none"> <li>• Ø 12 x 650 mm</li> <li>• with <b>turnable</b> closing head</li> <li>• <b>automatic locking</b></li> <li>• dark transparent cover</li> <li>• <b>braided cable</b></li> <li>• with dust cap</li> <li>• OEM</li> </ul>	<div style="text-align: right;"><b>12 x 650</b></div>  <div style="text-align: right;">UVP 5,90 €</div>

ART.-NR.	BESCHREIBUNG	DESCRIPTION	
 <b>230960</b> 60/10	<b>KABELSCHLOSS</b> <ul style="list-style-type: none"> <li>• geflochtenes Kabel</li> <li>• dunkel-transparenter Überzug</li> <li>• automatische Verriegelung</li> </ul> ›C 15.8 Illu‹ • Ø 15 x 800 mm • mit <b>Reflexstreifen</b> • auf M-Wave Eurolochkarte	<b>CABLE LOCK</b> <ul style="list-style-type: none"> <li>• braided cable</li> <li>• dark transparent cover</li> <li>• automatic locking</li> </ul> ›C 15.8 Illu‹ • Ø 15 x 800 mm • with <b>reflective stripe</b> • on M-Wave eurohole card	 <p>15 x 800</p> <p>REFLEX</p> <p>UVP 6,90 €</p>
<b>230161</b> 60/10	Montageverpackung ›C 15.8‹ Ø 15 x 800 mm	OEM ›C 15.8‹ Ø 15 x 800 mm	 <p>15 x 800</p> <p>UVP 6,90 €</p>
<b>230140</b> 100/10	›C 12.6‹ Ø 12 x 600 mm	›C 12.6‹ Ø 12 x 600 mm	 <p>12 x 600</p> <p>UVP 4,90 €</p>
<b>233700</b> NICE PRICE 200	Halter für Art. 230140, ...	bracket for art. 230140, ...	 <p>UVP 0,69 €</p>
<b>230086</b> 120/12	<b>KABELSCHLOSS</b> <ul style="list-style-type: none"> <li>• Ø 10 x 600 mm</li> <li>• automatische Verriegelung</li> <li>• großer Schließkopf</li> </ul> schwarz	<b>CABLE LOCK</b> <ul style="list-style-type: none"> <li>• Ø 10 x 600 mm</li> <li>• automatic locking</li> <li>• big closing head</li> </ul> black	 <p>10 x 600</p>
<b>230080</b>	farbig sortiert	assorted colours	 <p>UVP 2,90 €</p>

## PANZERGLIEDERSCHLÖSSER

## JOINT ARMORED LOCKS



<b>230815</b> 12	<b>PANZERGLIEDERSCHLOSS</b> ›H 24.10‹ <ul style="list-style-type: none"> <li>• Ø 24 x 1.000 mm</li> <li>• <b>starke Ausführung</b></li> <li>• dunkel-transparenter Überzug</li> <li>• viele verschiedene <b>computer-designte</b> Schlüsselvarianten</li> <li>• auf M-Wave Eurolochkarte</li> </ul>	<b>JOINT ARMORED LOCK</b> ›H 24.10‹ <ul style="list-style-type: none"> <li>• Ø 24 x 1,000 mm</li> <li>• <b>heavy duty</b></li> <li>• dark transparent cover</li> <li>• many different <b>computer-designed</b> key variants</li> <li>• on M-Wave eurohole card</li> </ul>	 <p>24 x 1.000</p> <p>UVP 14,90 €</p>
<b>230186</b> 30/10	<b>PANZERGLIEDERSCHLOSS</b> ›HD 18.8‹ <ul style="list-style-type: none"> <li>• Ø 18 x 800 mm</li> <li>• starke Ausführung</li> <li>• dunkel-transparenter Überzug</li> <li>• <b>5 Zahlenscheiben</b></li> <li>• <b>verstellbarer</b>, persönlicher Sicherheitscode</li> <li>• auf M-Wave Eurolochkarte</li> </ul>	<b>JOINT ARMORED LOCK</b> ›HD 18.8‹ <ul style="list-style-type: none"> <li>• Ø 18 x 800 mm</li> <li>• heavy duty</li> <li>• dark transparent cover</li> <li>• <b>5 digits</b></li> <li>• <b>changeable</b>, individual security code</li> <li>• on M-Wave eurohole card</li> </ul>	 <p>18 x 800</p> <p>5x</p> <p>UVP 11,90 €</p>





ART.-NR.	BESCHREIBUNG	DESCRIPTION	
230810 24	<b>PANZERGLIEDERSCHLOSS ›H 18.8‹</b> <ul style="list-style-type: none"> <li>• Ø 18 x 800 mm</li> <li>• mit <b>Staubschutzkappe</b></li> <li>• dunkel-transparenter Überzug</li> <li>• auf M-Wave Eurolochkarte</li> </ul>	<b>JOINT ARMORED LOCK ›H 18.8‹</b> <ul style="list-style-type: none"> <li>• Ø 18 x 800 mm</li> <li>• with <b>dust cap</b></li> <li>• dark transparent cover</li> <li>• on M-Wave eurohole card</li> </ul>	<b>18 x 800</b>  UVP 7,90 €

## KETTENSCHLÖSSER

## CHAIN LOCKS

230950 10	<b>KETTENSCHLOSS ›C 10.9-360‹</b> <ul style="list-style-type: none"> <li>• 10 x 10 x 900 mm</li> <li>• <b>besonders widerstandsfähig</b> durch <b>gehärtete quadratische Kettenglieder</b> und <b>robusten Schließzylinder</b></li> <li>• viele verschiedene <b>computer-designte</b> Schlüsselvarianten</li> <li>• <b>360° drehbarer Verschlusskopf</b></li> <li>• mit Staubschutzkappe</li> <li>• mit Textilüberzug</li> <li>• mit M-Wave Banderole</li> </ul>	<b>CHAIN LOCK ›C 10.9-360‹</b> <ul style="list-style-type: none"> <li>• 10 x 10 x 900 mm</li> <li>• <b>very robust</b> because of <b>hardened square chain links</b> and <b>robust cylinder lock</b></li> <li>• many different <b>computer-designed</b> key variants</li> <li>• <b>360° turnable lock head</b></li> <li>• with dust cap</li> <li>• with textile cover</li> <li>• with M-Wave banderole</li> </ul>	<b>10 x 10 x 900</b>  UVP 49,90 € 
--------------	--	---	---

230313 6	<b>KETTENSCHLOSS ›C 10.11‹</b> <ul style="list-style-type: none"> <li>• 10 x 10 x 1.100 mm</li> <li>• <b>besonders widerstandsfähig</b> durch <b>quadratische Kettenglieder</b></li> <li>• <b>automatische Verriegelung</b></li> <li>• viele verschiedene <b>computer-designte</b> Schlüsselvarianten</li> <li>• mit Textilüberzug</li> <li>• mit <b>Staubschutzkappe</b></li> <li>• mit M-Wave Banderole</li> </ul>	<b>CHAIN LOCK ›C 10.11‹</b> <ul style="list-style-type: none"> <li>• 10 x 10 x 1,100 mm</li> <li>• <b>very robust</b> because of <b>square chain links</b></li> <li>• <b>automatic locking</b></li> <li>• many different <b>computer-designed</b> key variants</li> <li>• with textile cover</li> <li>• with <b>dust cap</b></li> <li>• with M-Wave banderole</li> </ul>	<b>10 x 10 x 1.100</b>  UVP 24,90 €
-------------	--	--	--



230963 12/6	<b>KETTENSCHLOSS ›C 6.8,5 ILLU‹</b> mit <b>Reflexstreifen</b> <ul style="list-style-type: none"> <li>• Ø 6 x 850 mm</li> <li>• <b>automatische Verriegelung</b></li> <li>• mit Staubschutzkappe</li> <li>• viele verschiedene <b>computer-designte</b> Schlüsselvarianten</li> <li>• mit Textilüberzug</li> <li>• mit M-Wave Banderole</li> </ul>	<b>CHAIN LOCK ›C 6.8,5 ILLU‹</b> with <b>reflective stripe</b> <ul style="list-style-type: none"> <li>• Ø 6 x 850 mm</li> <li>• <b>automatic locking</b></li> <li>• with dust cap</li> <li>• many different <b>computer-designed</b> key varieties</li> <li>• with textile cover</li> <li>• with M-Wave banderole</li> </ul>	<b>6 x 850</b>  UVP 14,90 € 
----------------	--	---	---



















230315 12/6	<b>›C 6.8,5‹</b> ohne Reflexstreifen	<b>›C 6.8,5‹</b> without reflective stripe	 UVP 13,90 €
----------------	---	---	--

ART.-NR.	BESCHREIBUNG	DESCRIPTION	
230964 12/6	<b>ZAHLEN-KETTENSCHLOSS</b> <ul style="list-style-type: none"> <li>• Ø 6 x 850 mm</li> <li>• mit <b>5 Zahlenscheiben</b></li> <li>• mit <b>verstellbarem</b>, persönlichem Sicherheitscode</li> <li>• mit Textilüberzug</li> <li>• mit M-Wave Banderole</li> </ul> <b>›D 6,8,5 ILLU‹</b> mit Reflexstreifen	<b>COMBINATION CHAIN LOCK</b> <ul style="list-style-type: none"> <li>• Ø 6 x 850 mm</li> <li>• with <b>5 digits</b></li> <li>• with <b>changeable</b>, individual security codes</li> <li>• with textile cover</li> <li>• with M-Wave banderole</li> </ul> <b>›D 6,8,5 ILLU‹</b> with reflective stripe	<b>6 x 850</b> 
230316 12/6	<b>›D 6,8,5‹</b> ohne Reflexstreifen	<b>›D 6,8,5‹</b> without reflective stripe	
230317 20/10	<b>ZAHLEN-KETTENSCHLOSS</b> <b>›D 3,5,9‹</b> <ul style="list-style-type: none"> <li>• Ø 3,5 x 900 mm</li> <li>• mit <b>verstellbarem</b>, persönlichem Sicherheitscode</li> <li>• mit Textilüberzug</li> <li>• mit M-Wave Banderole</li> </ul>	<b>COMBINATION CHAIN LOCK</b> <b>›D 3,5,9‹</b> <ul style="list-style-type: none"> <li>• Ø 3.5 x 900 mm</li> <li>• with <b>changeable</b>, individual security code</li> <li>• with textile cover</li> <li>• with M-Wave banderole</li> </ul>	<b>3,5 x 900</b> 
230308 120/10	<b>ZAHLEN-KETTENSCHLOSS</b> <ul style="list-style-type: none"> <li>• Ø 2,2 x 500 mm</li> <li>• mit <b>4 Zahlenscheiben</b></li> <li>• transparenter Überzug</li> <li>• farbig sortiert</li> <li>• <b>verchromter</b> Schließkopf</li> <li>• Montageverpackung</li> </ul>	<b>COMBINATION CHAIN LOCK</b> <ul style="list-style-type: none"> <li>• Ø 2.2 x 500 mm</li> <li>• with <b>4 digits</b></li> <li>• transparent cover</li> <li>• assorted colours</li> <li>• <b>chromium closing</b> head</li> <li>• OEM</li> </ul>	<b>2,2 x 500</b> 

## FALTSCHLÖSSER

## FOLDING LOCKS

230196 16/4	<b>FALT-DISC-SCHLOSS ›F 600 D‹</b> <ul style="list-style-type: none"> <li>• 14 <b>starke</b>, halbrunde <b>Stahlglieder</b> mit Kunststoffüberzug</li> <li>• Länge 600 mm</li> <li>• <b>kompaktes Faltmaß</b>, ca. 7 cm x 5 cm</li> <li>• mit 2 Schlüsseln</li> <li>• mit Clip-on-Halter</li> <li>• Schloss <b>diebstahlsicher</b> am Halter fixierbar</li> <li>• in M-Wave Blisterverpackung</li> </ul>	<b>FOLDING DISC LOCK ›F 600 D‹</b> <ul style="list-style-type: none"> <li>• 14 <b>strong</b>, half-rounded <b>steel links</b> with plastic cover</li> <li>• length 600 mm</li> <li>• <b>compact folding size</b>, approx. 7 cm x 5 cm</li> <li>• with 2 keys</li> <li>• with clip-on bracket</li> <li>• <b>anti-theft-secured</b> fixing at the bracket</li> <li>• in M-Wave blister packaging</li> </ul>	<b>600 mm</b>  
----------------	---	--	--

ART.-NR.	BESCHREIBUNG	DESCRIPTION	
<p><b>230187</b></p> <p>6</p>	<p><b>FALTSCHLOSS ›F 1240/8‹</b></p> <ul style="list-style-type: none"> <li>• <b>XL: Länge 1.240 mm</b></li> <li>• <b>8 Glieder aus gehärtetem Stahl</b> mit Kunststoffummantelung, 8 x 25 x 165 mm</li> <li>• kompaktes Faltmaß: 210 x 92 x 50 mm</li> <li>• mit <b>Halterung</b> und Klettverschlüssen zur flexiblen Rahmenbefestigung oder zur Montage an den Flaschenhalterösen</li> <li>• 2 Schlüssel, davon <b>eine mit LED-Beleuchtung</b>, inkl. Batterien (1x CR 1220)</li> <li>• in M-Wave Blisterverpackung</li> </ul>	<p><b>FOLDING LOCK ›F 1240/8‹</b></p> <ul style="list-style-type: none"> <li>• <b>XL: length 1,240 mm</b></li> <li>• <b>8 hardened steel links</b> with plastic cover, 8 x 25 x 165 mm</li> <li>• folded size: 210 x 92 x 50 mm</li> <li>• with <b>bracket</b> and hook and loop fasteners for flexible frame attachment or mounting to the bottle cage eyelets</li> <li>• 2 keys, <b>one with LED light</b>, incl. batteries (1x CR 1220)</li> <li>• in M-Wave blister packaging</li> </ul> <p style="text-align: right;">UVP 48,90 €</p>	<div style="display: flex; justify-content: space-between;"> <div style="text-align: center;">  <p>SECURITY LEVEL</p> </div> <div style="text-align: center;"> <p><b>1.240 mm</b></p> <p><b>XL</b></p> </div> </div>   
<p><b>230194</b></p> <p>12/6</p>	<p><b>FALTSCHLOSS</b></p> <ul style="list-style-type: none"> <li>• Länge <b>875 mm</b></li> <li>• <b>6 Glieder aus gehärtetem Stahl</b> mit Kunststoffummantelung, 8 x 25 x 152 mm</li> <li>• kompaktes Faltmaß: 195 x 72 x 50 mm</li> <li>• mit <b>Halterung</b> und Klettverschlüssen zur Rahmenbefestigung oder zur Montage an den Flaschenhalterösen</li> <li>• 2 Schlüssel</li> </ul> <p><b>›F 875/6‹</b></p> <p>1 Schloss in M-Wave Blisterverpackung</p>	<p><b>FOLDING LOCK</b></p> <ul style="list-style-type: none"> <li>• length <b>875 mm</b></li> <li>• <b>6 hardened steel links</b> with plastic cover, 8 x 25 x 152 mm</li> <li>• folded size: 195 x 72 x 50 mm</li> <li>• with <b>bracket</b> and velcros for frame mounting or mounting to the bottle cage eyelets</li> <li>• 2 keys</li> </ul> <p><b>›F 875/6‹</b></p> <p>1 lock in M-Wave blister packaging</p> <p style="text-align: right;">UVP 34,90 €</p>	<div style="display: flex; justify-content: space-between;"> <div style="text-align: center;">  <p>SECURITY LEVEL</p> </div> <div style="text-align: center;"> <p><b>875 mm</b></p> </div> </div>   
<p><b>230197</b></p> <p>6 set</p>	<p><b>›F 875/6 TWIN‹</b></p> <ul style="list-style-type: none"> <li>• <b>Set aus zwei Schlössern</b> mit je <b>2 identischen Schlüsseln</b>, die je in beide Schließzylinder passen</li> <li>• 2 Schlösser in M-Wave Blisterverpackung</li> </ul>	<p><b>›F 875/6 TWIN‹</b></p> <ul style="list-style-type: none"> <li>• <b>set of two locks</b>, each with <b>2 identical keys</b>, which fit in both key cylinders</li> <li>• 2 locks in M-Wave blister packaging</li> </ul> <p style="text-align: right;">UVP 58,90 €</p>	<div style="display: flex; justify-content: space-between;"> <div style="text-align: center;"> <p><b>2x</b></p> </div> <div style="text-align: center;">  </div> <div style="text-align: center;">  </div> </div>
<p><b>230001</b></p> <p>25</p>	<p><b>MULTIFUNKTIONSSCHLOSS</b></p> <ul style="list-style-type: none"> <li>• super <b>klein</b> (Ø = 7,5 cm)</li> <li>• super <b>leicht</b> (nur 129 g)</li> <li>• <b>multifunktional</b> einsetzbar</li> <li>• <b>2 Schlaufen</b> für vielfältige Befestigungsmöglichkeiten</li> <li>• bedruckbare Werbefläche</li> <li>• 100 % <b>rostfrei</b></li> <li>• <b>variabel einstellbares</b> (bis 75 cm), bis <b>1.200 kg reißfestes Edelstahlseil</b></li> <li>• Verschluss ohne Schlüssel möglich</li> <li>• farbig sortiert</li> <li>• in Blisterverpackung</li> </ul>	<p><b>MULTIFUNCTION LOCK</b></p> <ul style="list-style-type: none"> <li>• super <b>compact</b> (Ø = 7.5 cm)</li> <li>• super <b>light</b> (only 129 g)</li> <li>• <b>multifunctionally</b> useable</li> <li>• <b>2 loops</b> give a lot of locking possibilities</li> <li>• individual ad space</li> <li>• 100 % <b>rust free</b></li> <li>• <b>variable length</b> (until 75 cm), up to <b>1,200 kg tensile strength stainless steel cable</b></li> <li>• closing possible without key</li> <li>• assorted colours</li> <li>• in blister packaging</li> </ul> <p style="text-align: right;">UVP 27,90 €</p>	  <div style="display: flex; justify-content: space-around; margin-top: 10px;">   </div>
<div style="display: flex; justify-content: space-around;"> <div style="text-align: center;"> <p>SKI</p>  </div> <div style="text-align: center;"> <p>SNOWBOARD</p>  </div> <div style="text-align: center;"> <p>BIKE</p>  </div> <div style="text-align: center;"> <p>BUGGY</p>  </div> <div style="text-align: center;"> <p>KOFFER</p>  </div> <div style="text-align: center;"> <p>SKATES .....</p>  </div> </div>			



ART.-NR.	BESCHREIBUNG	DESCRIPTION	
  <b>231820</b> <b>231821</b> <b>231822</b> 40	<b>KABELBINDER-SCHLOSS</b> <ul style="list-style-type: none"> <li>wiederverwendbar</li> <li>zur <b>einfachen</b> und <b>schnellen Kurzzeitsicherung</b></li> <li><b>vielseitig einsetzbar</b></li> <li>mit <b>Edelstahlkern</b></li> <li>passt in jede (Trikot-) Tasche</li> </ul> <b>›Z-LOK COMBO‹</b> <ul style="list-style-type: none"> <li>mit <b>Zahlenkombination</b></li> <li>430 mm lang</li> <li>mit <b>verstellbarem</b>, persönlichem Sicherheitscode</li> <li>auf Eurolochkarte</li> </ul> schwarz türkis gelb	<b>CABLE TIE LOCK</b> <ul style="list-style-type: none"> <li>reusable</li> <li>for an <b>easy</b> and <b>fast short time security</b></li> <li><b>universally useable</b></li> <li>with <b>stainless steel core</b></li> <li>fits into any (jersey) pocket</li> </ul> <b>›Z-LOK COMBO‹</b> <ul style="list-style-type: none"> <li>with <b>security code</b></li> <li>430 mm long</li> <li>with <b>changeable</b>, individual security codes</li> <li>on eurohole card</li> </ul> black turquoise yellow  UVP 22,90 €	    
<b>231800</b> <b>231801</b> <b>231802</b> 40 <b>231803</b> 20	<b>›Z-LOK‹</b> <ul style="list-style-type: none"> <li>mit <b>Schlüssel</b></li> <li>420 mm lang</li> </ul> auf Eurolochkarte schwarz blau orange	<b>›Z-LOK‹</b> <ul style="list-style-type: none"> <li>with <b>key</b></li> <li>420 mm long</li> </ul> on eurohole card black blue orange  in <b>display packaging</b> , 20 pcs. assorted colours (10 x schwarz, 5 x blau, 5 x orange)  UVP 10,90 €	  
<b>234000</b> 40/20	<b>ALARMANLAGE ›WATCH DOG‹</b> <ul style="list-style-type: none"> <li>automatische Alarmierung durch <b>Bewegungssensor</b></li> <li>Sensibilität <b>einstellbar</b></li> <li>Lautstärke <b>120 db</b></li> <li>Codierung mit 3 Zahlen persönlich <b>einstellbar</b></li> <li>Halter für Rohr-Ø 25 - 30 mm</li> <li>inkl. Batterie (9 V)</li> <li>in M-Wave Eurolochkarte</li> </ul>	<b>ALARM SYSTEM ›WATCH DOG‹</b> <ul style="list-style-type: none"> <li>automatic alarm by <b>movement sensor</b></li> <li><b>adjustable</b> sensitivity</li> <li>loudness <b>120 db</b></li> <li><b>adjustable</b> encoding by 3 numbers</li> <li>bracket for tubes with Ø 25 - 30 mm</li> <li>incl. battery (9 V)</li> <li>in M-Wave eurohole card</li> </ul> UVP 16,90 €	  
<b>230054</b> 128/16	<b>ALARMSCHLOSS ›LOCK'N'ROLL ALARM‹</b> Kleines, leichtes Aufrollschloss mit Alarmfunktion! <ul style="list-style-type: none"> <li><b>Alarm</b> bei <b>Bewegung</b> oder <b>Durchtrennen</b> des Kabels</li> <li><b>Empfindlichkeit einstellbar</b></li> <li>Lautstärke <b>90 db</b></li> <li>nur 84 g (o. Batterien)</li> <li>mit <b>4 Zahlenscheiben</b></li> <li>mit <b>verstellbarem</b>, persönlichem <b>Sicherheitscode</b></li> <li>Kabel <b>1,6 x 730 mm</b></li> <li>schwarzes Gehäuse</li> <li>inkl. Batterien</li> <li>in M-Wave Blisterverpackung</li> </ul>	<b>ALARM LOCK ›LOCK'N'ROLL ALARM‹</b> Small, light roll-up lock with alarm function! <ul style="list-style-type: none"> <li><b>alarm</b> when lock is <b>moved</b> or cable is <b>cut</b></li> <li><b>adjustable sensitivity</b></li> <li>loudness <b>90 db</b></li> <li>only 84 g (w/o batteries)</li> <li>with <b>4 digits</b></li> <li>with <b>changeable</b>, individual <b>security code</b></li> <li>cable <b>1.6 x 730 mm</b></li> <li>black housing</li> <li>incl. batteries</li> <li>in M-Wave blister packaging</li> </ul> UVP 29,90 €	   

ART.-NR.	BESCHREIBUNG	DESCRIPTION	
<b>230051</b> 96/12	<b>AUFROLL-KABELSCHLOSS</b> <b>›LOCK'N'ROLL D 24.9‹</b> Klein, leicht und praktisch! Durch Knopfdruck rollt sich das Kabel selbst auf. • mit <b>4 Zahlenscheiben</b> • mit <b>verstellbarem</b> , persönlichem Sicherheitscode • Kabel <b>2,4 x 900 mm</b> • Gehäuse dunkel-transparent • auf M-Wave Eurolochkarte	<b>ROLL UP CABLE LOCK</b> <b>›LOCK'N'ROLL D 24.9‹</b> Small, light and handy! By pressing the button the cable rolls up automatically. • with <b>4 digits</b> • with <b>changeable</b> , individual security code • cable <b>2.4 x 900 mm</b> • dark transparent housing • on M-Wave eurohole card	 <p><b>2.4 x 900</b></p>  <p>UVP 9,90 €</p>
<b>230340</b> 10	<b>ABSPERRKABEL</b> • mit <b>2 Schlaufenenden</b> • zur <b>Verlängerung des Absperrradius</b> • ideal um mehrere Räder zu sichern • ideal auch in Verbindung mit kleinen Bügelschlössern z. B. Art. 230121, ... • auf M-Wave Eurolochkarte <b>›S 10.50 L‹</b> 10 x 5.000 mm	<b>LOCK CABLE</b> • with <b>2 loopends</b> • for <b>extending the locking range</b> • protection of multiple bicycles • ideal in conjunction with small u-locks e. g. art. 230121, ... • on M-Wave eurohole card <b>›S 10.50 L‹</b> 10 x 5,000 mm	 <p><b>10 x 5.000</b></p>  <p>UVP 14,90 €</p>
<b>230130</b> 60/10	<b>›S 8.18 L‹</b> 8 x 1.800 mm	<b>›S 8.18 L‹</b> 8 x 1,800 mm	 <p><b>8 x 1.800</b></p>  <p>UVP 4,90 €</p>
<b>230121</b>  <b>230120</b> 72/8	<b>VORHÄNGESCHLOSS ›PD 5‹</b> • mit <b>5 Zahlenscheiben</b> • mit <b>verstellbarem</b> , persönlichem Sicherheitscode • Bügel aus <b>gehärtetem Stahl</b> • <b>7 mm</b> Bügelstärke auf M-Wave Eurolochkarte Montageverpackung	<b>PADLOCK ›PD 5‹</b> • with <b>5 digits</b> • with <b>changeable</b> , individual security code • <b>hardened steel</b> shackle • <b>7 mm</b> shackle thickness on M-Wave eurohole card OEM	 <p><b>5x</b></p> <p>40 mm, 30 mm, 64 mm</p>  <p>UVP 8,90 €</p>
<b>230124</b> 200/40	<b>VORHÄNGESCHLOSS ›PD 3 L‹</b> • mit <b>3 Zahlenscheiben</b> • mit Mini-Spiralkabel <b>3 x 1200 mm</b> • Überzug transparent smoke • mit <b>verstellbarem</b> , persönlichem Sicherheitscode • auch geeignet zum Sichern von Taschen, Helmen am Fahrrad, ... • auf M-Wave-Eurolochkarte	<b>PADLOCK ›PD 3 L‹</b> • with <b>3 digits</b> • with mini spiral cable <b>3 x 1200 mm</b> • cover transparent smoke • with <b>changeable</b> , individual security code • also suitable to secure bags, helmets on the bike, ... • on M-Wave eurohole card	  <p>UVP 4,90 €</p>

ART.-NR. BESCHREIBUNG

DESCRIPTION

## BÜGELSCHLÖSSER

## U-LOCKS

### 234022 ZAHLEN-BÜGELSCHLOSS ›BD 260‹

10/5

TIP

- mit Halter
- mit **4 Zahlenscheiben**
- mit **verstellbarem**, persönlichem Sicherheitscode
- Ø 14 mm Bügelstärke
- Außenmaß: 124 x 260 mm
- Innenmaß: 76 x 200 mm
- mit M-Wave Banderole

### DIGIT U-LOCK ›BD 260‹

- with bracket
- with **4 digits**
- with **changeable**, individual security code
- Ø 14 mm shackle thickness
- outer size: 124 x 260 mm
- inner size: 76 x 200 mm
- with M-Wave banderole

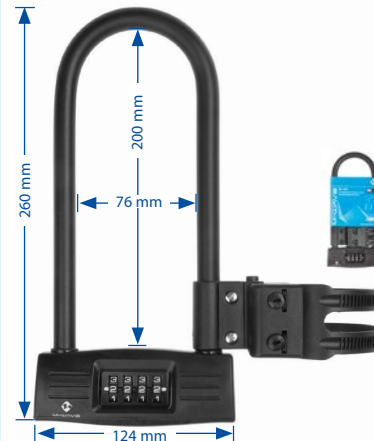

UVP 21,90 €

### 234025 BÜGELSCHLOSS MIT SPIRALKABEL ›B & S‹

20 set

- Set aus **Bügel Schloss** und **Spiralkabel**
- zur optimalen Sicherung des Fahrrads
- mit M-Wave Banderole

- Spiralkabel mit Schlaufen** (Art. 230130)
- **8 x 1.800 mm**
  - mit 2 unterschiedlich großen **Schlaufenenden**
  - zur **Verlängerung des Absperrradius**

- Bügel Schloss** (Art. 234012)
- mit Halter und Staubschutzkappe
  - **erhöhte Sicherheit** durch quadratische Form
  - Ø 15 mm Bügelstärke
  - Außenmaß: 165 x 247 mm
  - Innenmaß: 106 x 188 mm
  - viele verschiedene **computer-designte** Schlüsselvarianten

### U-LOCK WITH SPIRAL CABLE ›B & S‹

- set of **u-lock** and **spiral cable**
- for optimum protection of the bicycle
- with M-Wave banderole

- loop spiral cable** (art. 230130)
- **8 x 1,800 mm**
  - with **2 loopends** of different size
  - for **extending the locking range**

- u-lock** (art. 234012)
- with bracket and dust cap
  - **increased security** through square shape
  - Ø 15 mm shackle thickness
  - outer size: 165 x 247 mm
  - inner size: 106 x 188 mm
  - many different **computer-designed** key variants

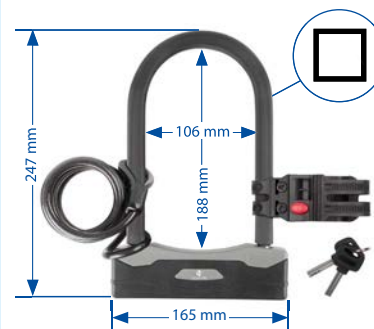

UVP 19,90 €

### 234012 BÜGELSCHLOSS ›B 247‹

20/5

- mit Halter und Staubschutzkappe
- **erhöhte Sicherheit** durch quadratische Form
- **Ø 15 mm** Bügelstärke
- Außenmaß: 165 x 247 mm
- Innenmaß: 106 x 188 mm
- viele verschiedene **computer-designte** Schlüsselvarianten
- mit M-Wave Banderole

### U-LOCK ›B 247‹

- with bracket and dust cap
- **increased security** through square shape
- **Ø 15 mm** shackle thickness
- outer size: 165 x 247 mm
- inner size: 106 x 188 mm
- many different **computer-designed** key variants
- with M-Wave banderole

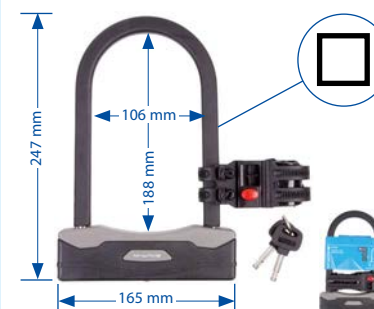

UVP 14,90 €

### 234010 BÜGELSCHLOSS ›B 245‹

20/5

- mit Halter und Staubschutzkappe
- **Ø 14 mm** Bügelstärke
- Außenmaß: 197 x 245 mm
- Innenmaß: 105 x 205 mm
- viele verschiedene **computer-designte** Schlüsselvarianten
- mit M-Wave Eurolochkarte

### U-LOCK ›B 245‹

- with bracket and dust cap
- **Ø 14 mm** shackle thickness
- outer size: 197 x 245 mm
- inner size: 105 x 205 mm
- many different **computer-designed** key variants
- with M-Wave eurohole card

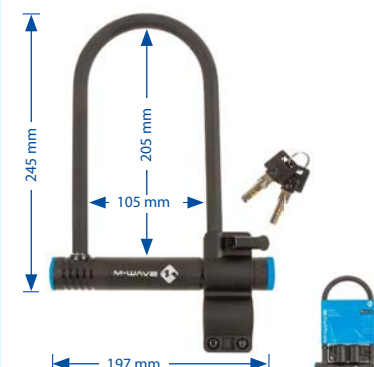

UVP 12,90 €







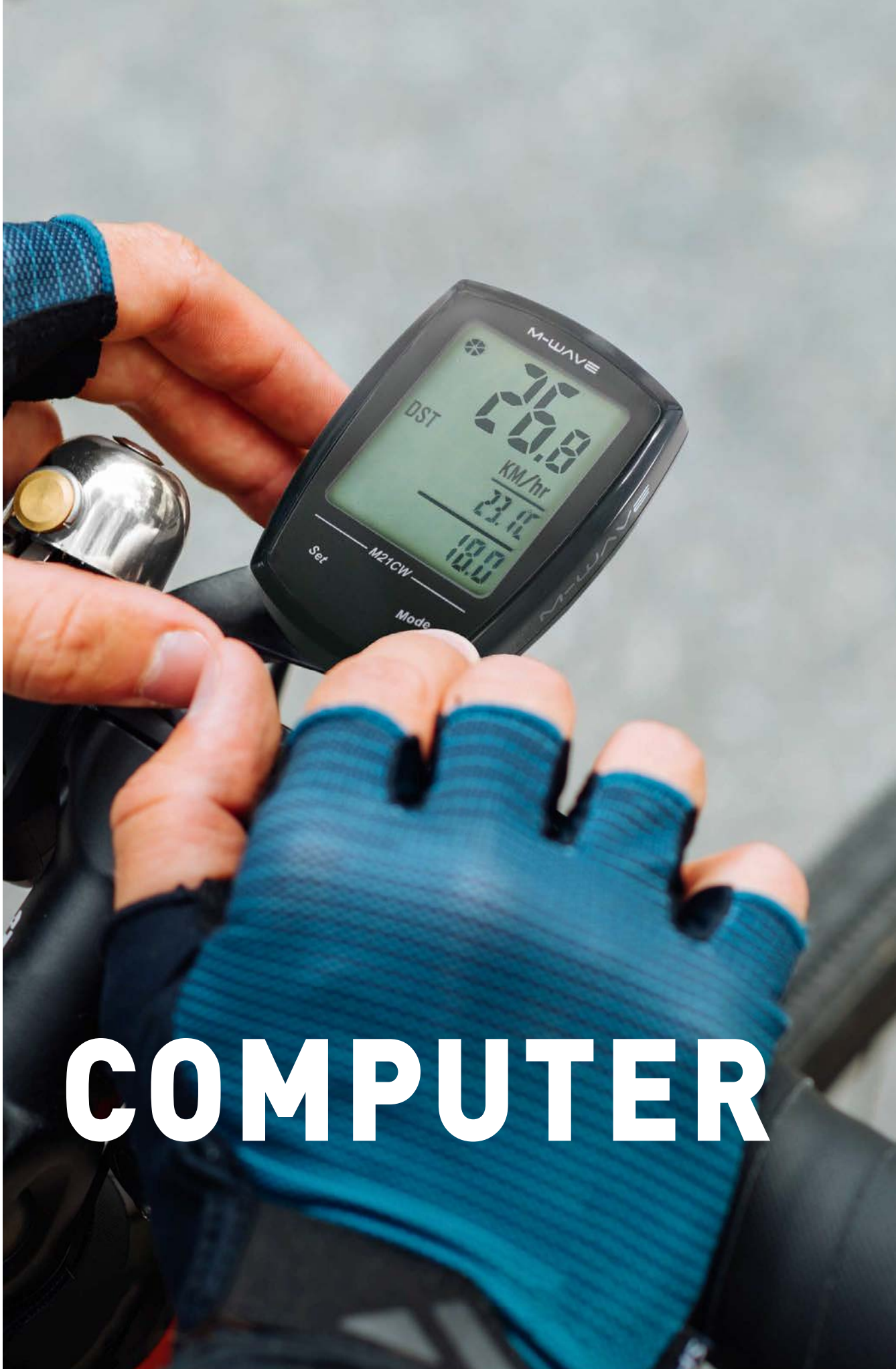

















ART.-NR.	BESCHREIBUNG	DESCRIPTION	
			
RAHMENSCHLÖSSER		FRAME LOCKS	
	<b>RAHMENSCHLOSS ›BOOSTER‹</b> <ul style="list-style-type: none"> <li>• <b>Fahrradschloss und Brake-Booster</b></li> <li>• kann sowohl bei <b>gedeferten, als auch ungefederten</b> Rädern an den Brems-Pivots der <b>Vorderradgabel und des Hinterbaus</b> montiert werden</li> <li>• zusätzliche Befestigungsmöglichkeit <b>an der Platte zw. den Sitzrohrstreben</b></li> <li>• auf M-Wave Eurolochkarte</li> </ul>	<b>FRAME LOCK ›BOOSTER‹</b> <ul style="list-style-type: none"> <li>• <b>bicycle lock and brake booster</b></li> <li>• can be mounted on bikes <b>with suspension</b> or bikes <b>w/o suspension</b> on the brake-pivots of <b>front fork and seat stays</b></li> <li>• also possible to fasten <b>on the seat stay plate</b></li> <li>• on M-Wave eurohole card</li> </ul>	
231440	silber	silver	
231441	schwarz	black	
40/10			UVP 29,90 €
231451	<b>RAHMENSCHLOSS MIT KETTE ›RINGCHAIN XL‹</b> <ul style="list-style-type: none"> <li>• <b>70 mm Durchlaufbreite für besonders breite Reifen</b></li> <li>• für Montage an der Pletscherplatte oder den Sitzrohrstreben</li> <li>• mit <b>quadratischen Kettengliedern, 5,5 x 5,5 x 1.000 mm</b> (Art. 231452) zur <b>Verlängerung des Absperrradius</b>, mit schwarzem Textilüberzug</li> <li>• Kette mit Klettriemen zum Aufrollen und Fixieren</li> <li>• mit Befestigungsmaterial</li> <li>• auf M-Wave Eurolochkarte</li> </ul>	<b>FRAME LOCK WITH CHAIN ›RINGCHAIN XL‹</b> <ul style="list-style-type: none"> <li>• <b>70 mm inner width for very wide tires</b></li> <li>• for mounting on the Pletscher plate or seat stays</li> <li>• with <b>square chain links, 5.5 x 5.5 x 1,000 mm</b> (art. 231452) for <b>extending the locking range</b>, with black textile cover</li> <li>• chain with hook and loop straps for rolling up and fixing</li> <li>• with mounting material</li> <li>• on M-Wave eurohole card</li> </ul>	
10			UVP 24,90 €
	<b>SCHLOSSKETTE</b> <ul style="list-style-type: none"> <li>• <b>Ersatz-/Verlängerungskette</b> für Rahmenschloss Art. 231451 und <b>andere Rahmenschlösser</b></li> <li>• zur Verlängerung des Absperrradius</li> <li>• mit schwarzem Textilüberzug</li> <li>• Kette mit Klettriemen zum Aufrollen und Fixieren</li> <li>• Montageverpackung</li> </ul>	<b>LOCK CHAIN</b> <ul style="list-style-type: none"> <li>• <b>replacement and extension chain</b> for frame lock art. 231451 and <b>other frame locks</b></li> <li>• for extending the locking range</li> <li>• with black textile cover</li> <li>• chain with hook and loop straps for rolling up and fixing</li> <li>• OEM</li> </ul>	
231452	›C 5,5,10‹ 5,5 x 5,5 x 1.000 mm	›C 5,5,10‹ 5,5 x 5,5 x 1,000 mm	UVP 9,90 €
231453	›C 5,5,14‹ 5,5 x 5,5 x 1.400 mm	›C 5,5,14‹ 5,5 x 5,5 x 1,400 mm	UVP 11,90 €
20			
122357	<b>AUFBEWAHRUNGSTASCHE FÜR SCHLOSSKETTEN ›TILBURG M‹</b> <ul style="list-style-type: none"> <li>• mit Clip-on-Halter (Art. 122299)</li> <li>• durch Reißverschluss nach unten <b>erweiterbar</b></li> <li>• mit <b>Rücklichthalter</b> und 3 <b>Klett-riemen</b> unten (z. B. für Luftpumpe)</li> <li>• mit Reflexstreifen</li> <li>• Größe: ca. 160 x 80 mm</li> <li>• Höhe: ca. 80 - 150 mm</li> </ul>	<b>STORAGE BAG FOR LOCK CHAINS ›TILBURG M‹</b> <ul style="list-style-type: none"> <li>• with clip-on bracket (art. 122299)</li> <li>• through zipper <b>expandable</b> at the bottom</li> <li>• with <b>light bracket</b> and 3 <b>hook and loop fasteners</b> at the bottom (e. g. for pump)</li> <li>• with reflective stripes</li> <li>• size: approx. 160 x 80 mm</li> <li>• height: approx. 80 - 150 mm</li> </ul>	
100			UVP 6,90 €







# COMPUTER









ART.-NR.	BESCHREIBUNG	DESCRIPTION	
<b>244631</b> 100/10    	<b>FAHRRADCOMPUTER ›U10W‹</b> <b>10 Funktionen mit Funkübertragung der Geschwindigkeit:</b> <ul style="list-style-type: none"> <li>• Geschwindigkeit: akt./Ø</li> <li>• Kilometer: Tag/Gesamt</li> <li>• Fahrzeit</li> <li>• perm. Vergleich akt. Geschwindigkeit/Ø-Geschwindigkeit</li> <li>• Uhrzeit (12/24 Stunden Anzeige)</li> <li>• autom. Anzeigenwechsel</li> <li>• <b>CO<sub>2</sub>-Ersparnis</b></li> <li>• Temperatur</li> <li>• Kilometer-/Meilenauswahl</li> <li>• Raddurchmesser einstellbar</li> <li>• inkl. Batterien (CR 2032, Art. 640814)</li> <li>• wassergeschützt</li> </ul>	<b>BICYCLE COMPUTER ›U10W‹</b> <b>10 functions with wireless speed transmission:</b> <ul style="list-style-type: none"> <li>• speed: current/Ø</li> <li>• distance: trip/total</li> <li>• riding time</li> <li>• speed pacer</li> <li>• 12/24 hour clock</li> <li>• auto scan</li> <li>• <b>CO<sub>2</sub> saving</b></li> <li>• temperature</li> <li>• kilometres/miles selection</li> <li>• wheel diameter adjustable</li> <li>• incl. batteries (CR 2032, art. 640814)</li> <li>• water-protected</li> </ul> <p style="text-align: right;">UVP 33,90 €</p>	   
<b>244622</b> 100  	<b>FAHRRADCOMPUTER ›U12‹</b> <b>12 Funktionen:</b> <ul style="list-style-type: none"> <li>• Geschwindigkeit: akt./Ø/max.</li> <li>• Kilometer: Tag/Gesamt</li> <li>• Fahrzeit: Tag/Gesamt</li> <li>• perm. Vergleich akt. Geschwindigkeit/Ø-Geschwindigkeit</li> <li>• Uhrzeit (12/24 Stunden Anzeige)</li> <li>• autom. Anzeigenwechsel</li> <li>• <b>CO<sub>2</sub>-Ersparnis:</b> akt./Gesamt</li> <li>• Kilometer-/Meilenauswahl</li> <li>• Raddurchmesser einstellbar</li> <li>• inkl. Batterie (CR 2032, Art. 640814)</li> <li>• wassergeschützt</li> </ul>	<b>BICYCLE COMPUTER ›U12‹</b> <b>12 functions:</b> <ul style="list-style-type: none"> <li>• speed: current/Ø/max.</li> <li>• distance: trip/total</li> <li>• riding time: trip/total</li> <li>• speed pacer</li> <li>• 12/24 hour clock</li> <li>• auto scan</li> <li>• <b>CO<sub>2</sub> saving:</b> current/total</li> <li>• kilometres/miles selection</li> <li>• wheel diameter adjustable</li> <li>• incl. battery (CR 2032, art. 640814)</li> <li>• water-protected</li> </ul> <p style="text-align: right;">UVP 17,90 €</p>	  
<b>244621</b> 100  	<b>FAHRRADCOMPUTER ›U9‹</b> <b>9 Funktionen:</b> <ul style="list-style-type: none"> <li>• Geschwindigkeit: akt./Ø</li> <li>• Kilometer: Tag/Gesamt</li> <li>• Fahrzeit</li> <li>• perm. Vergleich akt. Geschwindigkeit/Ø-Geschwindigkeit</li> <li>• Uhrzeit (12/24 Stunden Anzeige)</li> <li>• autom. Anzeigenwechsel</li> <li>• <b>CO<sub>2</sub>-Ersparnis</b></li> <li>• Kilometer-/Meilenauswahl</li> <li>• Raddurchmesser einstellbar</li> <li>• inkl. Batterie (CR 2032, Art. 640814)</li> <li>• wassergeschützt</li> </ul>	<b>BICYCLE COMPUTER ›U9‹</b> <b>9 functions:</b> <ul style="list-style-type: none"> <li>• speed: current/Ø</li> <li>• distance: trip/total</li> <li>• riding time</li> <li>• speed pacer</li> <li>• 12/24 hour clock</li> <li>• auto scan</li> <li>• <b>CO<sub>2</sub> saving</b></li> <li>• kilometres/miles selection</li> <li>• wheel diameter adjustable</li> <li>• incl. battery (CR 2032, art. 640814)</li> <li>• water-protected</li> </ul> <p style="text-align: right;">UVP 16,90 €</p>	  
<b>244620</b> 100 	<b>FAHRRADCOMPUTER ›U4‹</b> <b>4 Funktionen mit 3-fach Anzeige:</b> <ul style="list-style-type: none"> <li>• Geschwindigkeit: akt./Ø</li> <li>• Kilometer: Tag/Gesamt</li> <li>• autom. Anzeigenwechsel</li> <li>• Kilometer-/Meilenauswahl</li> <li>• Raddurchmesser einstellbar</li> <li>• inkl. Batterien (CR 2032, Art. 640814)</li> <li>• wassergeschützt</li> </ul>	<b>BICYCLE COMPUTER ›U4‹</b> <b>4 functions with three line display:</b> <ul style="list-style-type: none"> <li>• speed: current/Ø</li> <li>• distance: trip/total</li> <li>• auto scan</li> <li>• kilometres/miles selection</li> <li>• wheel diameter adjustable</li> <li>• incl. batteries (CR 2032, art. 640814)</li> <li>• water-protected</li> </ul> <p style="text-align: right;">UVP 13,90 €</p>	  

ART.-NR. 	BESCHREIBUNG	DESCRIPTION	
<b>244608</b> 100/10	<b>SERVICE SETUP TOOL 'ECHOPAD'</b> zur <b>leichten und schnellen</b> Einstellung der <b>wichtigsten Daten</b> wie Radumfang, Uhr, ...	<b>SERVICE SETUP TOOL 'ECHOPAD'</b> for <b>quick and easy</b> setup of the most <b>important data</b> like wheel circumference, clock, ....	 <p style="text-align: right;">UVP 34,90 €</p>
<b>244605</b> 10	<b>DISPLAY</b> <ul style="list-style-type: none"> <li>für vier Fahrradcomputer</li> <li>mit Testrad zum Drehen</li> <li><b>individuelle</b> Beschriftungsmöglichkeit</li> <li><b>universell</b> passend für alle Echowell-Computer</li> </ul>	<b>DISPLAY</b> <ul style="list-style-type: none"> <li>for four bicycle computers</li> <li>with test wheel for turning</li> <li><b>individual</b> labelling opportunity</li> <li><b>universally</b> suitable for all Echowell computers</li> </ul>	 <p style="text-align: right;">UVP 29,90 €</p>
<b>244600</b> 100/10 set	<b>ERSATZ-/ZUSATZHALTER-SETS</b> <ul style="list-style-type: none"> <li>jeweils mit Unterleggummis, Befestigungsringen und Kabelbindern</li> <li>in Echowell Eurolochbox</li> </ul> <b>244600</b> <ul style="list-style-type: none"> <li>passend für Art. 244620 (U4), Art. 244621 (U9), Art. 244622 (U12)</li> <li>Halter mit Sensor und <b>extra langem 120 cm Kabel</b> (auch geeignet für Montage an der Kettenstrebe bei Benutzung auf Rollentrainer)</li> </ul>	<b>REPLACEMENT/ADDITIONAL BRACKET SETS</b> <ul style="list-style-type: none"> <li>with rubber strips, mounting rings and cable ties</li> <li>in Echowell eurohole box</li> </ul> <b>244600</b> <ul style="list-style-type: none"> <li>suitable for art. 244620 (U4), art. 244621 (U9), art. 244622 (U12)</li> <li>bracket with sensor and <b>extra long 120 cm cable</b> (also suitable for mounting at the chainstay when using a resistance trainer)</li> </ul>	 <p style="text-align: right;">UVP 9,90 €</p>
<b>244601</b> 100 set	<b>244601</b> <ul style="list-style-type: none"> <li>passend für <b>kabellose</b> Computer, z. B. Art. 244631 (U10W)</li> <li>Halter</li> </ul>	<b>244601</b> <ul style="list-style-type: none"> <li>suitable for <b>wireless</b> computers, e. g. art. 244631 (U10W)</li> <li>bracket</li> </ul>	 <p style="text-align: right;">UVP 5,90 €</p>
<b>244603</b> 100 set	<b>244603</b> <b>ERSATZ-/ZUSATZSENDER</b> <ul style="list-style-type: none"> <li>für <b>kabellose</b> Fahrradcomputer</li> <li>für <b>Geschwindigkeitsfunktionen</b></li> <li>passend für Art. 244631 (U10W)</li> <li>Sensor mit Batterie</li> <li>Halter</li> </ul>	<b>244603</b> <b>REPLACEMENT/ADDITIONAL TRANSMITTER</b> <ul style="list-style-type: none"> <li>for <b>wireless</b> bicycle computers</li> <li>for <b>speed modes</b></li> <li>suitable for art. 244631 (U10W)</li> <li>sensor with battery</li> <li>bracket</li> </ul>	 <p style="text-align: right;">UVP 12,90 €</p>
<b>640814</b> 20/5 set	<b>640814</b> <b>BATTERIEN FÜR COMPUTER</b> <ul style="list-style-type: none"> <li>hochwertige <b>Maxell</b> Lithiumbatterie CR 2032</li> <li>passend auch für Lampen, Computer, ...</li> <li>5 Stück auf <b>Abreißkarte</b></li> </ul>	<b>640814</b> <b>BATTERIES FOR COMPUTER</b> <ul style="list-style-type: none"> <li>high quality <b>Maxell</b> lithium battery CR 2032</li> <li>also suitable for lamps, computers, ...</li> <li>5 pcs on <b>breakaway card</b></li> </ul>	<b>LITHIUM</b>  <p style="text-align: right;">UVP 7,90 €</p>

ART.-NR.	BESCHREIBUNG	DESCRIPTION	
	<p><b>M-WAVE COMPUTER – KLEINER PREIS – GROSSE LEISTUNG</b></p> <ul style="list-style-type: none"> <li>• <b>gut lesbares</b> und temperaturbeständiges Display</li> <li>• <b>japanische Batterien</b></li> <li>• doppelte <b>Qualitätskontrolle</b></li> <li>• super Preis-Leistungsverhältnis</li> </ul>	<p><b>M-WAVE COMPUTER – LOW PRICE – BIG PERFORMANCE</b></p> <ul style="list-style-type: none"> <li>• <b>easy-to-read</b> and temperature-resistant display</li> <li>• <b>Japanese batteries</b></li> <li>• double <b>quality check</b></li> <li>• super price-performance ratio</li> </ul>	
<p><b>244750</b></p> <p>100/10</p>      	<p><b>FAHRRADCOMPUTER ›M21W‹</b></p> <p><b>21 Funktionen mit Touchscreen und Funkübertragung:</b></p> <ul style="list-style-type: none"> <li>• Geschwindigkeit: akt. / Ø / max.</li> <li>• Geschwindigkeitsvergleich</li> <li>• Gesamt- / Tageskilometer</li> <li>• Kilometerstand speichern</li> <li>• automatischer Fahrzeitmesser</li> <li>• automatischer Anzeigenwechsel</li> <li>• Digitaluhr</li> <li>• Stoppuhr</li> <li>• Kalorienzähler</li> <li>• Temperaturanzeige</li> <li>• Auto Start / Stopp</li> <li>• Kilometer- / Meilenauswahl</li> <li>• Displaybeleuchtung</li> <li>• Service Programm</li> <li>• Screenshot-Funktion</li> <li>• Batteriezustandsanzeige</li> <li>• inkl. Batterien (CR 2032, Art. 640814)</li> <li>• Montage am <b>Lenker oder Vorbau</b></li> <li>• Ersatz-/Zusatzhalter-Set Art. 244797</li> </ul>	<p><b>BICYCLE COMPUTER ›M21W‹</b></p> <p><b>21 functions with touchscreen and wireless transmission:</b></p> <ul style="list-style-type: none"> <li>• speed: current / Ø / max.</li> <li>• speed comparator</li> <li>• total distance / trip distance</li> <li>• odometer save function</li> <li>• auto trip timer</li> <li>• auto scan</li> <li>• digital clock</li> <li>• stopwatch</li> <li>• calorie consumption</li> <li>• temperature</li> <li>• auto start / stop</li> <li>• kilometres / miles selection</li> <li>• display backlight</li> <li>• service program</li> <li>• freeze frame function</li> <li>• battery level indicator</li> <li>• incl. batteries (CR 2032, art. 640814)</li> <li>• mounting at the <b>handlebar or stem</b></li> <li>• additional replacement bracket set art. 244797</li> </ul>	 <p>SENSO TOUCH TECHNOLOGIE</p>   <p>UVP 26,90 €</p>
<p><b>244732</b></p> <p>20</p>    	<p><b>FAHRRADCOMPUTER ›M14W‹</b></p> <p><b>14 Funktionen mit digitaler Funkübertragung:</b></p> <ul style="list-style-type: none"> <li>• Geschwindigkeit: akt. / Ø / max.</li> <li>• Geschwindigkeitstendenz / -vergleich</li> <li>• Gesamt- / Tageskilometer</li> <li>• Kilometerstand speichern</li> <li>• automatischer Fahrzeitmesser</li> <li>• automatischer Anzeigenwechsel</li> <li>• Screenshot-Funktion</li> <li>• Digitaluhr</li> <li>• Auto Start / Stopp</li> <li>• Auto An / Aus</li> <li>• Kilometer- / Meilenauswahl</li> <li>• Raddurchmesser einstellbar</li> <li>• wassergeschützt (IP 44)</li> <li>• inkl. Batterien (CR 2032, Art. 640814)</li> <li>• <b>werkzeuglose Montage</b> am Lenker oder Vorbau (Ersatz-/Zusatzhalter-Set Art. 244796)</li> <li>• Anleitungen in CS, DE, EN, FR, HU, IT, NL, PL</li> </ul>	<p><b>BICYCLE COMPUTER ›M14W‹</b></p> <p><b>14 functions with digital wireless transmission:</b></p> <ul style="list-style-type: none"> <li>• speed: current / Ø / max.</li> <li>• speed tendency / speed comparator</li> <li>• total distance / trip distance</li> <li>• odometer save function</li> <li>• auto trip timer</li> <li>• auto scan</li> <li>• freeze frame function</li> <li>• digital clock</li> <li>• auto start / stop</li> <li>• auto power on / off</li> <li>• kilometres / miles selection</li> <li>• adjustable wheel size</li> <li>• water protected (IP 44)</li> <li>• incl. batteries (CR 2032, art. 640814)</li> <li>• <b>toolless mounting</b> at the handlebar or stem (additional replacement bracket set art. 244796)</li> <li>• manuals in CS, DE, EN, FR, HU, IT, NL, PL</li> </ul>	   <p>UVP 28,90 €</p>



ART.-NR.	BESCHREIBUNG	DESCRIPTION	
<p><b>244733</b></p> <p>20</p>    	<p><b>FAHRRADCOMPUTER ›M16‹</b></p> <p><b>16 Funktionen:</b></p> <ul style="list-style-type: none"> <li>• Geschwindigkeit: akt. / Ø / max.</li> <li>• Geschwindigkeitstendenz / -vergleich</li> <li>• Gesamt- / Tageskilometer</li> <li>• Kilometerstand speichern</li> <li>• automatischer Fahrzeitmesser</li> <li>• automatischer Anzeigenwechsel</li> <li>• Service Programm</li> <li>• Screenshot-Funktion</li> <li>• Digitaluhr</li> <li>• Temperaturanzeige: °C / °F wählbar</li> <li>• Auto Start / Stopp</li> <li>• Auto An / Aus</li> <li>• Kilometer- / Meilenauswahl</li> <li>• Raddurchmesser einstellbar</li> <li>• wassergeschützt (IP 44)</li> <li>• inkl. Batterie (CR 2032, Art. 640814)</li> <li>• <b>werkzeuglose Montage</b> am Lenker oder Vorbau (Ersatz- / Zusatzhalter-Set Art. 244795)</li> <li>• Anleitungen in CS, DE, EN, FR, HU, IT, NL, PL</li> </ul>	<p><b>BICYCLE COMPUTER ›M16‹</b></p> <p><b>16 functions:</b></p> <ul style="list-style-type: none"> <li>• speed: current / Ø / max.</li> <li>• speed tendency / speed comparator</li> <li>• total distance / trip distance</li> <li>• odometer save function</li> <li>• auto trip timer</li> <li>• auto scan</li> <li>• service program</li> <li>• freeze frame function</li> <li>• digital clock</li> <li>• temperature: °C / °F selectable</li> <li>• auto start / stop</li> <li>• auto power on / off</li> <li>• kilometres / miles selection</li> <li>• adjustable wheel size</li> <li>• water protected (IP 44)</li> <li>• incl. batteries (CR 2032, art. 640814)</li> <li>• <b>toolless mounting</b> at the handlebar or stem (additional replacement bracket set art. 244795)</li> <li>• manuals in CS, DE, EN, FR, HU, IT, NL, PL</li> </ul> <p>UVP 16,90 €</p>	 
<p><b>244734</b></p> <p>20</p>   	<p><b>FAHRRADCOMPUTER ›M12‹</b></p> <p><b>12 Funktionen:</b></p> <ul style="list-style-type: none"> <li>• Geschwindigkeit: akt. / Ø / max.</li> <li>• Geschwindigkeitstendenz / -vergleich</li> <li>• Gesamt- / Tageskilometer</li> <li>• automatischer Fahrzeitmesser</li> <li>• automatischer Anzeigenwechsel</li> <li>• Digitaluhr</li> <li>• Auto Start / Stopp</li> <li>• Auto An / Aus</li> <li>• Kilometer- / Meilenauswahl</li> <li>• Raddurchmesser einstellbar</li> <li>• wassergeschützt (IP 44)</li> <li>• inkl. Batterie (CR 2032, Art. 640814)</li> <li>• <b>werkzeuglose Montage</b> am Lenker oder Vorbau (Ersatz- / Zusatzhalter-Set Art. 244795)</li> <li>• Anleitungen in CS, DE, EN, FR, HU, IT, NL, PL</li> </ul>	<p><b>BICYCLE COMPUTER ›M12‹</b></p> <p><b>12 functions:</b></p> <ul style="list-style-type: none"> <li>• speed: current / Ø / max.</li> <li>• speed tendency / comparator</li> <li>• total distance / trip distance</li> <li>• auto trip timer</li> <li>• auto scan</li> <li>• digital clock</li> <li>• auto start / stop</li> <li>• auto power on / off</li> <li>• kilometres / miles selection</li> <li>• adjustable wheel size</li> <li>• water protected (IP 44)</li> <li>• incl. batteries (CR 2032, art. 640814)</li> <li>• <b>toolless mounting</b> at the handlebar or stem (additional replacement bracket set art. 244795)</li> <li>• manuals in CS, DE, EN, FR, HU, IT, NL, PL</li> </ul> <p>UVP 15,90 €</p>	  <div style="border: 1px solid black; padding: 2px; text-align: center;"> <p><b>aktiv Radfahren</b></p> <p><b>EMPFEHLUNG</b></p> <p><b>SEHR GUT</b></p> <p>6/2018</p> </div>
<p><b>244710</b></p> <p><b>244714</b></p> <p><b>244715</b></p> <p><b>244718</b></p> <p>100/10</p>    	<p><b>FAHRRADCOMPUTER ›XIV SILICONE‹</b></p> <p><b>Mit farbigen, austauschbaren Silikonhüllen</b></p> <p><b>14 Funktionen:</b></p> <ul style="list-style-type: none"> <li>• <b>digitale Funkübertragung</b></li> <li>• Geschwindigkeit: akt. / Ø / max.</li> <li>• Geschwindigkeitstendenz / -vergleich</li> <li>• Gesamt- / Tageskilometer</li> <li>• automatischer Anzeigenwechsel</li> <li>• Uhrzeit</li> <li>• CO<sup>2</sup>-Ersparnis</li> <li>• Kalorienzähler</li> <li>• Temperaturanzeige: °C / °F wählbar</li> <li>• Auto Start / Stopp</li> <li>• Kilometer- / Meilenauswahl</li> <li>• Raddurchmesser einstellbar</li> <li>• inkl. Batterie (L1154F, Art. 640828)</li> <li>• wassergeschützt</li> <li>• <b>werkzeuglose Montage</b> am Lenker oder Vorbau und um <b>90° drehbar</b></li> <li>• Anleitungen in CS, DE, EN, FR, HU, IT, NL, PL</li> </ul>	<p><b>BICYCLE COMPUTER ›XIV SILICONE‹</b></p> <p><b>With coloured, exchangeable silicone covers</b></p> <p><b>14 functions:</b></p> <ul style="list-style-type: none"> <li>• <b>digital wireless transmission</b></li> <li>• speed: current / Ø / max.</li> <li>• speed tendency / comparator</li> <li>• total distance / trip distance</li> <li>• auto scan</li> <li>• clock</li> <li>• CO<sup>2</sup> emission reduction</li> <li>• calorie consumption</li> <li>• temperature: °C / °F selectable</li> <li>• auto start / stop</li> <li>• kilometres / miles selection</li> <li>• adjustable wheel size</li> <li>• incl. battery (L1154F, art. 640828)</li> <li>• water protected</li> <li>• <b>toolless mounting</b> at the handlebar or stem and <b>90° rotatable</b></li> <li>• manuals in CS, DE, EN, FR, HU, IT, NL, PL</li> </ul> <p><b>black</b> silicone cover UVP 31,90 €</p> <p><b>yellow</b> silicone cover UVP 26,90 €</p> <p><b>rose</b> silicone cover UVP 26,90 €</p> <p><b>orange</b> silicone cover UVP 26,90 €</p>	  

ART.-NR.	BESCHREIBUNG	DESCRIPTION	
<b>244799</b> 20 set	<b>ERSATZTEILE FÜR M-WAVE COMPUTER</b> Ersatz- / Zusatzsender • <b>Geschwindigkeitssensor</b> und <b>Trittfrequenzsensor</b> • für <b>kabellose</b> Fahrradcomputer Art. 244730 und 244731 • inkl. Batterien • inkl. Montagematerial • Montageverpackung	<b>SPARE PARTS FOR M-WAVE COMPUTER</b> Replacement / additional transmitters • <b>sensor for speed and cadence</b> • for <b>wireless</b> bicycle computers art. 244730 and 244731 • incl. batteries • incl. mounting material • OEM UVP 29,90 €	
<b>244796</b> 10 set	Ersatz- / Zusatzhalter-Set • für <b>kabellose</b> Fahrradcomputer Art. 244730, 244731 und 244732 • im Polybeutel mit M-Wave Header	Replacement / additional bracket set • for <b>wireless</b> bicycle computers art. 244730, 244731 and 244732 • in PE bag with M-Wave header UVP 4,90 €	
<b>244795</b> 10 set	Ersatz- / Zusatzhalter-Set • für Fahrradcomputer Art. 244733 und 244734 • im Polybeutel mit M-Wave Header	Replacement / additional bracket set • for bicycle computers art. 244733 and 244734 • in PE bag with M-Wave header UVP 5,90 €	
<b>244361</b> 100/20 	<b>FAHRRADCOMPUTER &gt;XIV W&lt;</b> <b>14 Funktionen mit 3-fach Anzeige</b> • <b>drahtlose Funkübertragung</b> • Geschwindigkeit • Durchschnittsgeschwindigkeit • maximale Geschwindigkeit • Geschwindigkeitsvergleich • Gesamtkilometer • Tageskilometer • Fahrzeit • Uhrzeit • Kalorienverbrauchsanzeige • Umdrehungsfrequenz pro Min. • autom. Anzeigenwechsel • Kilometer- / Meilenauswahl • Raddurchmesser einstellbar • Auto Stopp • inkl. Batterie (CR 2026) • wassergeschützt • mit 90° drehbarem Universalhalter • Bedienungsanleitung in CS, DE, EN, ES, FR, HU, IT, NL, PL • in Ventura Eurolochbox	<b>BICYCLE COMPUTER &gt;XIV W&lt;</b> <b>14 functions with three line display</b> • <b>wireless transmission</b> • current speed • average speed • maximum speed • speed comparator • total trip distance • trip distance • auto trip timer • clock • calorie consumption • round frequency per min. • auto scan • kilometres / miles selection • wheel diameter adjustable • auto stop • incl. battery (CR 2026) • water-protected • with 90° turnable universal bracket • manual in CS, DE, EN, ES, FR, HU, IT, NL, PL • in Ventura eurohole box UVP 21,90 €	 <p>3-fach 3-line Display</p> 
<b>244527</b> 120/24	<b>FAHRRADCOMPUTER &gt;XI&lt;</b> <b>11 Funktionen mit 3-fach Anzeige:</b> • Geschwindigkeit • maximale Geschwindigkeit • Durchschnittsgeschwindigkeit • Gesamtkilometer • Tageskilometer • autom. Anzeigenwechsel • Uhrzeit • Auto Start / Stopp • Fahrzeit • Kilometer- / Meilenauswahl • Raddurchmesser einstellbar • inkl. Batterie (CR 2032, Art. 640814/6) • wassergeschützt • mit 90° drehbarem Universalhalter • Bedienungsanleitung in CS, DE, EN, ES, FR, HU, IT, NL, PL • in Ventura Eurolochbox	<b>BICYCLE COMPUTER &gt;XI&lt;</b> <b>11 functions with three line display:</b> • current speed • maximum speed • average speed • total trip distance • trip distance • auto scan • clock • auto start / stop • riding time • kilometres / miles selection • wheel diameter adjustable • incl. battery (CR 2032, art. 640814/6) • water-protected • with 90° turnable universal bracket • manual in CS, DE, EN, ES, FR, HU, IT, NL, PL • in Ventura eurohole box UVP 11,90 €	 <p>3-fach 3-line Display</p> 

ART.-NR. 	BESCHREIBUNG	DESCRIPTION	
<p><b>244550</b></p> <p><b>244554</b></p> <p><b>244555</b></p> <p><b>244553</b></p> <p>120/24</p>	<p><b>FAHRRADCOMPUTER ›VENTURA X‹</b></p> <p><b>10 Funktionen mit Doppelanzeige:</b></p> <ul style="list-style-type: none"> <li>• Geschwindigkeit</li> <li>• maximale Geschwindigkeit</li> <li>• Durchschnittsgeschwindigkeit</li> <li>• Gesamtkilometer</li> <li>• Tageskilometer</li> <li>• autom. Anzeigenwechsel</li> <li>• Stoppuhr</li> <li>• Uhrzeit</li> <li>• Auto Start / Stopp</li> <li>• Kilometer- / Meilenauswahl</li> <li>• Raddurchmesser einstellbar</li> <li>• inkl. Batterie (LR44, Art. 640828)</li> <li>• wassergeschützt</li> <li>• Bedienungsanleitung in CS, DE, EN, FR, HU, IT, NL, PL</li> <li>• in Ventura Eurolochbox</li> </ul>	<p><b>BICYCLE COMPUTER ›VENTURA X‹</b></p> <p><b>10 functions with double display:</b></p> <ul style="list-style-type: none"> <li>• speed</li> <li>• maximum speed</li> <li>• average speed</li> <li>• total distance</li> <li>• trip distance</li> <li>• auto scan</li> <li>• stop watch</li> <li>• clock</li> <li>• auto start / stop</li> <li>• kilometres / miles selection</li> <li>• wheel diameter adjustable</li> <li>• incl. battery (LR44, art. 640828)</li> <li>• water-protected</li> <li>• manual in CS, DE, EN, FR, HU, IT, NL, PL</li> <li>• in Ventura eurohole box</li> </ul>	     <p style="text-align: right;">UVP 9,90 €</p>
<p><b>244530</b></p> <p>120/24</p>	<p><b>FAHRRADCOMPUTER ›VENTURA VI‹</b></p> <p><b>mit Doppelanzeige 6 Funktionen:</b></p> <ul style="list-style-type: none"> <li>• Geschwindigkeit</li> <li>• Gesamtkilometer</li> <li>• Tageskilometer</li> <li>• autom. Anzeigenwechsel</li> <li>• Stoppuhr</li> <li>• Uhrzeit</li> <li>• Auto Start / Stop</li> <li>• inkl. Batterie LR44, Art. 640828</li> <li>• wassergeschützt</li> <li>• Bedienungsanleitung in CS, DE, EN, FR, HU, IT, NL, PL</li> <li>• in Ventura Eurolochbox</li> </ul>	<p><b>BICYCLE COMPUTER ›VENTURA VI‹</b></p> <p><b>with double display 6 functions:</b></p> <ul style="list-style-type: none"> <li>• speed</li> <li>• total distance</li> <li>• trip distance</li> <li>• auto scan</li> <li>• stop watch</li> <li>• clock</li> <li>• auto start / stop</li> <li>• incl. battery LR44, art. 640828</li> <li>• water-protected</li> <li>• manual in CS, DE, EN, FR, HU, IT, NL, PL</li> <li>• in Ventura eurohole box</li> </ul>	  <p style="text-align: right;">UVP 8,90 €</p>
<p><b>244265</b></p> <p>100</p>	<p><b>ERSATZTEILE FÜR VENTURA COMPUTER</b></p> <p>Magnet</p> <ul style="list-style-type: none"> <li>• universell passend auch für <b>Messerspeichen</b></li> </ul>	<p><b>SPARE PARTS FOR VENTURA COMPUTER</b></p> <p>magnet</p> <ul style="list-style-type: none"> <li>• universally fitting also for <b>aero spokes</b></li> </ul>	 <p style="text-align: right;">UVP 2,90 €</p>
<p><b>244273</b></p> <p>300</p>	<p>Halter mit <b>extra langem Kabel</b> (140 cm), daher auch für Hinterradmontage geeignet</p> <ul style="list-style-type: none"> <li>• auch zur Benutzung auf <b>Rollentrainer</b></li> <li>• für Art. 244530/244550/3-5, 244527</li> <li>• um <b>90° drehbar</b>: Vorbau- und Lenkermontage möglich</li> <li>• für Ø 22,2 - 35,0 mm</li> <li>• werkzeuglose Montage</li> <li>• mit <b>Sensor</b> und <b>Magnet</b></li> <li>• inkl. versch. Befestigungsmaterialien</li> </ul>	<p>bracket with <b>extra long cable</b> (140 cm), therefore also usable for rear wheel mounting</p> <ul style="list-style-type: none"> <li>• for using on <b>roll trainer</b></li> <li>• for art. 244530/244550/3-5, 244527</li> <li>• <b>90° turnable</b>: mounting on stem or handlebar possible</li> <li>• from Ø 22.2 - 35.0 mm</li> <li>• toolless mounting</li> <li>• with <b>sensor</b> and <b>magnet</b></li> <li>• incl. various fixation materials</li> </ul>	 <p style="text-align: right;">UVP 3,90 €</p>



ART.-NR.	BESCHREIBUNG	DESCRIPTION	
<b>NEW</b>	<b>HALTER FÜR AIRTAG &gt;AIRBELL&lt;</b>	<b>BRACKET FOR AIRTAG &gt;AIRBELL&lt;</b>	
	<ul style="list-style-type: none"> <li>• unauffälliger Halter für den Apple AirTag Sender in Glockenform</li> <li>• schwarz</li> </ul>	<ul style="list-style-type: none"> <li>• unobtrusively bell-shaped holder for the Apple AirTag transmitter</li> <li>• black</li> </ul>	
<b>420651</b>	Lenkerklemmung Ø 22 mm auf AirBell Eurolochkarte	handlebar clamp Ø 22 mm on AirBell eurohole card	
50			
<b>420650</b>	Montageverpackung	OEM	UVP 19,90 €
200			
<b>420654</b>	Lenkerklemmung Ø 31,8 mm auf AirBell Eurolochkarte	handlebar clamp Ø 31.8 mm on AirBell eurohole card	
100			
<b>420653</b>	Montageverpackung	OEM	UVP 22,90 €
200			

## SICHERHEIT FÜR DEIN BIKE



**SICHER**  
**UNAUFFÄLLIG**  
**EINZIGARTIG**



• Apple AirTag\* einfach einsetzen



\*Apple AirTag nicht enthalten

empfohlen von:



eBikeNews

ct magazin für  
computer  
technik

GIGA

Computer  
Bild

<b>NEW</b>	<b>HALTER FÜR AIRTAG &gt;AIRCASE BC&lt;</b>	<b>BRACKET FOR AIRTAG &gt;AIRCASE BC&lt;</b>	
	<ul style="list-style-type: none"> <li>• ermöglicht die unauffällige Anbringung des Apple AirTag Senders unter dem Flaschenhalter</li> <li>• inkl. längerer Schrauben</li> </ul>	<ul style="list-style-type: none"> <li>• enables the Apple AirTag transmitter to be unobtrusively attached under the bottle cage</li> <li>• incl. extra long screws</li> </ul>	
<b>245026</b>	auf M-Wave Eurolochkarte	on M-Wave eurohole card	
200			
<b>245025</b>	Montageverpackung	OEM	UVP 14,90 €
400			

ART.-NR. 	BESCHREIBUNG	DESCRIPTION	
	<p><b>MODULARES HALTERSYSTEM ›QRIR‹</b></p> <ul style="list-style-type: none"> <li>• <b>vielseitige Kombinationsmöglichkeiten</b> von Haltern und Adaptern für Lampen, Trinkflaschen, Fahrrad-computer, Action-Kameras, ...</li> <li>• optimale Anpassung an die <b>individuellen Bedürfnisse</b> jedes Rad-fahrers</li> <li>• <b>CNC-gefrästes Aluminium</b></li> <li>• Verbindungs-Konstruktion auch für GoPro geeignet (keine original GoPro Ersatzteile)</li> <li>• auf M-Wave Eurolochkarte</li> </ul> <p><b>ADAPTER</b></p> <ul style="list-style-type: none"> <li>• für Ahead Steuersatz</li> <li>• 1½" und verjüngt</li> <li>• für Flaschenhalter-Adapter (Art. 390636), Lenkercockpit (Art. 390637) oder Lampenhalter (Art. 390638)</li> </ul>	<p><b>MODULAR BRACKET SYSTEM ›QRIR‹</b></p> <ul style="list-style-type: none"> <li>• <b>versatile combinations</b> of brackets and adapters for lamps, water bottles, cycle computers, action cams, ...</li> <li>• optimal adaptation to the <b>individual needs</b> of every cyclist</li> <li>• <b>CNC machined aluminium</b></li> <li>• connection construction also suitable for GoPro (no original GoPro spare parts)</li> <li>• on M-Wave eurohole card</li> </ul> <p><b>ADAPTER</b></p> <ul style="list-style-type: none"> <li>• for ahead head set</li> <li>• 1½" and tapered</li> <li>• for bottle cage adapter (art. 390636), handlebar cockpit (art. 390637) or lamp bracket (art. 390638)</li> </ul>	
<p><b>390650</b> 100</p>	<p><b>Distanzring ›QRIR Spacer‹</b> Höhe: 10 mm</p>	<p><b>Spacer ›QRIR Spacer‹</b> height: 10 mm</p>	 <p>UVP 7,90 €</p>
<p><b>390635</b> 500</p>	<p><b>Ahead-Kappe ›QRIR Top‹</b></p>	<p><b>Ahead cap ›QRIR Top‹</b></p>	 <p>UVP 8,90 €</p>
<p><b>390637</b> 120</p>	<p><b>HALTER</b> für Distanzring (Art. 390650) und Ahead-Kappe (Art. 390635)</p> <p><b>Lenkercockpit ›QRIR Cockpit‹</b></p> <ul style="list-style-type: none"> <li>• universelle Montage von Lampen, Fahrradcomputern, E-Bike Displays, ...</li> <li>• Klemmdurchmesser: 22,2 mm</li> <li>• Rohr: 90 x 22,2 mm</li> <li>• <b>Zusatzfunktion:</b> Bei Entnahme des "Cockpit-Rohres" ist eine umgekehrte Montage am Lenker möglich. So können die Halter Art. 390636/8, Scheinwerfer, ... problemlos im <b>Ø 22,2 mm-Klemmbereich des Lenkers</b> montiert werden.</li> </ul>	<p><b>BRACKET</b> for spacer (art. 390650) and ahead cap (art. 390635)</p> <p><b>Handlebar cockpit ›QRIR Cockpit‹</b></p> <ul style="list-style-type: none"> <li>• universal mounting of lamps, bicycle computers, e-bike displays ...</li> <li>• clamp diameter: 22.2 mm</li> <li>• tube: 90 x 22.2 mm</li> <li>• <b>additional function:</b> When removing the "cockpit tube" a reverse mounting on the handlebar is possible. Thus, the brackets art. 390636/8, head lights, ... can be easily mounted at the <b>Ø 22.2 mm clamp area of the handlebar.</b></li> </ul>	 <div style="display: flex; justify-content: space-around;"> <div data-bbox="1181 1321 1372 1500"> <p><b>FUNCTION 1</b></p>  </div> <div data-bbox="1380 1321 1532 1500"> <p><b>FUNCTION 2</b></p>  </div> </div> <p>UVP 12,90 €</p>
<p><b>390636</b></p>	<p><b>Flaschenhalter ›QRIR Bottle‹</b></p> <ul style="list-style-type: none"> <li>• zur Montage eines Flaschenhalters</li> <li>• Winkel stufenlos einstellbar</li> </ul>	<p><b>Bottle cage ›QRIR Bottle‹</b></p> <ul style="list-style-type: none"> <li>• for mounting of a bottle cage</li> <li>• steplessly adjustable angle</li> </ul>	 <p>UVP 7,90 €</p>
<p><b>390638</b> 100</p>	<p><b>Lampenhalter ›QRIR Extender‹</b></p> <ul style="list-style-type: none"> <li>• zur Montage eines Scheinwerfers</li> <li>• auch in Kombination mit der Klemme des Lenkercockpits (Art. 390637) im <b>Ø 22,2 mm-Klemmbereich des Lenkers</b> montierbar</li> </ul>	<p><b>Lamp bracket ›QRIR Extender‹</b></p> <ul style="list-style-type: none"> <li>• for mounting of a head light</li> <li>• can also be used in combination with the clamp of the handlebar cockpit (art. 390637) for mounting at the <b>Ø 22.2 mm clamp area of the handlebar</b></li> </ul>	 <div style="display: flex; justify-content: space-around;"> <div data-bbox="1189 1892 1356 2027">  </div> <div data-bbox="1189 2038 1356 2139"> <p>Art. 390637 + 390638</p>  </div> </div> <p>UVP 7,90 €</p>

ART.-NR. 	BESCHREIBUNG	DESCRIPTION	
<b>244698</b> 50	<b>LENKERHALTER ›DAVENPORT ARM‹</b> <ul style="list-style-type: none"> <li>• Positionierung vor dem Lenker für <b>bessere Ablesbarkeit</b> und <b>zusätzlichen Platz</b> am Lenker</li> <li>• universell passend für <b>Garmin Edge</b> Serie und <b>Garmin Forerunner</b> Serie (Schnellwechselkit nicht enthalten, kein original Garmin Ersatzteil)</li> <li>• sehr <b>stabil</b> und <b>passgenau</b> durch <b>CNC-gefrästes Aluminium</b></li> <li>• für Lenkerdurchmesser <b>22,2 - 31,8 mm</b></li> <li>• Länge einstellbar</li> <li>• auf M-Wave Eurolochkarte</li> </ul>	<b>HANDLEBAR BRACKET ›DAVENPORT ARM‹</b> <ul style="list-style-type: none"> <li>• positioning in front of the handlebar for better <b>readability</b> and <b>more space</b> at the handlebar</li> <li>• universally suitable for <b>Garmin Edge</b> series and <b>Garmin Forerunner</b> series (quick change kit not included, no original Garmin spare part)</li> <li>• very <b>stable</b> and <b>accurately fitting</b> by <b>CNC machined aluminium</b></li> <li>• for <b>22.2 - 31.8 mm</b> handlebar diameter</li> <li>• length adjustable</li> <li>• on M-Wave eurohole card</li> </ul>	 <p style="text-align: right;">UVP 40,90 €</p>
<b>244691</b> 100/20	<b>AHEADKAPPEN-HALTERUNG ›DAVENPORT AHEAD‹</b> <ul style="list-style-type: none"> <li>• zur <b>Gabelschaft- / Ahead-Montage</b> (1½")</li> <li>• universell passend für Garmin, ... (kein original Garmin, ... Ersatzteil)</li> <li>• auf M-Wave Eurolochkarte</li> </ul>	<b>AHEAD CAP BRACKET ›DAVENPORT AHEAD‹</b> <ul style="list-style-type: none"> <li>• for <b>steerer / ahead-cap mount</b> (1½")</li> <li>• universally suitable for Garmin, ... (no original Garmin, ... spare part)</li> <li>• on M-Wave eurohole card</li> </ul>	 <p style="text-align: right;">UVP 10,90 €</p>
<b>244690</b> 100/20	<b>UNIVERSELLE ADAPTERPLATTE ›DAVENPORT PLUG‹</b> <ul style="list-style-type: none"> <li>• zur <b>Befestigung von Mobiltelefonen, Navigationsgeräten, ... auf Garmin-Halterungen</b> (kein original Garmin Ersatzteil)</li> <li>• mit <b>3M</b> Klebepad und Sicherheits-schrauben</li> <li>• <b>Hand- und Sicherheitsschlaufe</b> verhindert unbeabsichtigtes Herunterfallen des Gerätes</li> <li>• auf M-Wave Eurolochkarte</li> </ul>	<b>UNIVERSAL ADAPTER PLATE ›DAVENPORT PLUG‹</b> <ul style="list-style-type: none"> <li>• for <b>mounting of mobile phones, navigation devices, ... to Garmin mounts</b> (no original Garmin spare part)</li> <li>• with <b>3M</b> glue pad and safety screws</li> <li>• <b>hand and safety sling</b> prevents the device from accidentally falling</li> <li>• on M-Wave eurohole card</li> </ul>	 <p style="text-align: right;">UVP 6,90 €</p>





Das Leben ist wie eine Radtour, es ist voll von Höhen und Tiefen, Bergen und Kurven. Auf dieser Fahrt ist es gut zu wissen, dass man sich auf einige Dinge verlassen kann. Seit über 40 Jahren ergänzt, vervollständigt und optimiert Velo Ihre Radtour, weil die Sättel von Velo für hohe Funktionalität, maximale Qualität & Komfort, einen attraktiven Preis und einen, dem Zeitgeist angepassten, Look stehen.

Life is like a bike ride, full of ups and downs, bumps and curves. And in this ride it is good to know that you can rely on certain things. For more than 40 years Velo amends, completes and optimises your bicycle tour. The reason is that Velo stands for high functionality, maximum quality & comfort, an attractive price and a look which is aligned with the zeitgeist.

## WE ARE TECHNOLOGY

Über 15 Millionen Sättel werden Jahr für Jahr an Fahrrädern montiert, die Velo für seine eigenen Marken "Velo" und "Prologo" und für andere namhafte Sattelmarken produziert. Zahlreiche Patente, die heute an diesen zig Millionen Sätteln Einsatz finden, gehen zurück auf Velo.

Over 15 million saddles are mounted every year, which Velo has produced for its own brands "Velo" and "Prologo" and for other renowned saddle brands. Numerous patents, which are used for all the millions of saddles today, originate from Velo.

## OUR TECHNOLOGY

<b>TOP</b>	Leder Leather	wasserdicht waterproof	Vakuump- technologie Vacuum technology	Spezial- Schaum special foam	„Memory“- Schaum „Memory“ foam				
<b>INLAY</b>	Luftpolster Air pads	Geleinlage Gel insert	Waben- Geleinlage Honeycomb gel	D2-Schale Double density base	O-Zone- Ausschnitt O-Zone full cut	Druck- entlastung Channel	Spezial- Schaum special foam	„Memory“- Schaum „Memory“ foam	SOFT TOUGH Air Form air form
<b>BASE</b>	O-Zone-Schalen- ausschnitt O-Zone base cut	Druck- entlastung „ProPortion“	Luftstrom- kühlung Airthru Cool	Netz-Druck- entlastung NetTech suspension	Abriebschutz X-tra protection	E-Bike Griff E-Bike grip	Sattel Erhöhung Saddle rise		
<b>RAIL</b>	Gestell- federung ArcTech- suspension	Gestell- federung CrossBow suspension	Elastomer- Federung Elastomer suspension	Spiralfederung Coil Spring	Netzfederung WebSpring	besonderes Gestellmaterial special rail material			

# VELO-FIT



Finden Sie Ihren Weg in die Velo Comfort Zone  
Find your way to the Velo Comfort Zone

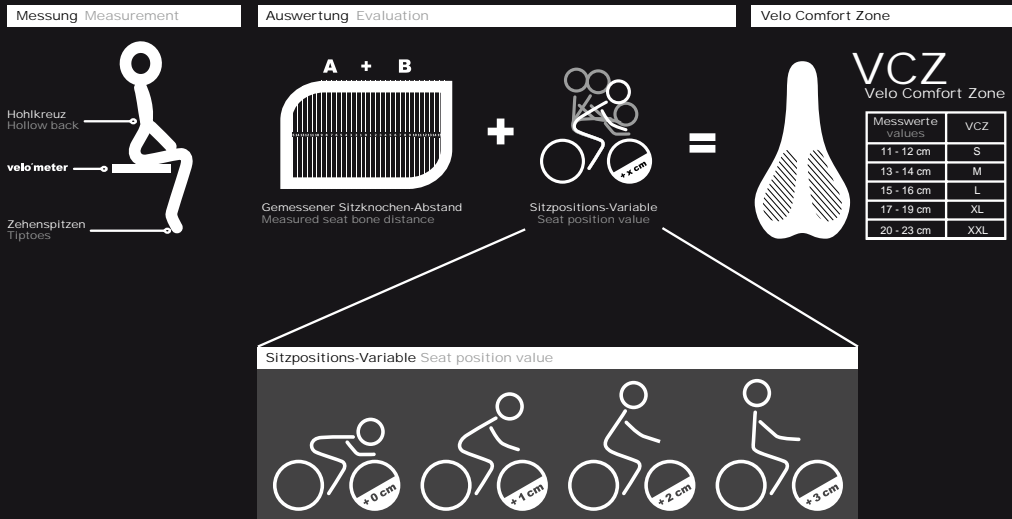

## Die richtige Sattelbreite - ganz einfach ermitteln mit unserem VELO-FIT System

Durch das Sitzgel im Velometer (Art. 250599) kann anhand eines Sitzabdrucks bestimmt werden, wie groß der Sitzknochenabstand ist. Je nach der favorisierten Sitzposition werden 0 bis 3 cm addiert. So erhalten Sie die beste, auf den Kunden zugeschnittene, Sattelbreite und die dazu passende VCZ (Velo Comfort Zone). Suchen Sie sich dann einfach Ihren individuellen Sattel mit der passenden VCZ aus unseren VELO-FIT Sätteln aus.

## The right saddle width - easily chosen by our VELO-FIT System

Through the sit-on gel of the Velometer (art. 250599) a visible print of the seat hump can be made, so it gets measurable. Depending on the riding position you add 0 - 3 cm as shown on the Velometer. With this you get the best confection size on saddles and the matching VCZ (Velo Comfort Zone). Pick out easily your individual saddle from our VELO-FIT saddle range.



ART.-NR. 	BESCHREIBUNG	DESCRIPTION	VCZ = Velo Comfort Zone
<b>250599</b> 10	<b>MESSSYSTEM ›VELOMETER‹</b> <ul style="list-style-type: none"> <li>• Gel Pad zur Bestimmung des <b>Sitzknochen-Abstands</b></li> <li>• hochwertiger Kunststoff mit schwarzem <b>Gel Pad</b></li> <li>• mit <b>Skala</b></li> <li>• Gebrauchsanweisung auf der Rückseite</li> <li>• Montageverpackung</li> </ul>	<b>MEASURE SYSTEM ›VELOMETER‹</b> <ul style="list-style-type: none"> <li>• gel pad for definition of <b>seat bone distance</b></li> <li>• high quality plastic with black <b>gel pad</b></li> <li>• with <b>scale</b></li> <li>• manual on back</li> <li>• OEM</li> </ul>	
UVP 49,90 €			
	<b>E-BIKE-SATTEL ›VELO-FIT E1‹</b> <p>Immer die richtige Sattelbreite finden dank unseres Velo-Fit-Systems. Die neue „E1“-Serie bietet jetzt auch <b>spezielle Details für den Einsatz auf E-Bikes:</b></p> <ul style="list-style-type: none"> <li>• Abstützung durch <b>Sattelerhöhung</b> hinten mit <b>Non-Slip</b>-Einlage</li> <li>• <b>Griffmulde „I-Carry“</b> hinten für besseres Handling</li> <li>• <b>Atmos Shape:</b> wasserdichter und sauberer Übergang durch Verklebung des Obermaterials mit der Unterschale</li> <li>• <b>Air Form:</b> Das Material ist im oberen Bereich weicher, unten härter und dichter. Dadurch besserer Langzeit-Sitzkomfort</li> <li>• „Arc-Tech“ <b>gedfederter</b> Stützpunkt</li> <li>• <b>CroMo</b>-Gestell mit Skala</li> <li>• auf Velo Eurolochkarte</li> </ul> <b>250550 Größe M:</b> <ul style="list-style-type: none"> <li>• L = 270 x B = 145 mm</li> <li>• optimal für VCZ <b>M</b> (130 - 140 mm)</li> </ul> <b>250551 Größe L:</b> <ul style="list-style-type: none"> <li>• L = 270 x B = 160 mm</li> <li>• optimal für VCZ <b>L</b> (150 - 160 mm)</li> </ul> <b>250552 Größe XL:</b> <ul style="list-style-type: none"> <li>• L = 270 x B = 176 mm</li> <li>• optimal für VCZ <b>XL</b> (170 - 190 mm)</li> </ul> <b>250553 Größe XXL:</b> <ul style="list-style-type: none"> <li>• L = 270 x B = 190 mm</li> <li>• optimal für VCZ <b>XXL</b> (200 - 230 mm)</li> </ul>	<b>E-BIKE SADDLE ›VELO-FIT E1‹</b> <p>Always find the right saddle width thanks to our Velo-Fit system. The new “E1” series now also offers <b>special details for use on e-bikes:</b></p> <ul style="list-style-type: none"> <li>• support by <b>saddle rise</b> with <b>non-slip</b> insert</li> <li>• <b>recessed grip “I-Carry”</b> for better handling</li> <li>• <b>Atmos Shape:</b> waterproof and clean cross-over by gluing the upper material to the base shell</li> <li>• <b>Air Form:</b> the material is softer at the top, harder and denser at the bottom. This gives better long-term seating comfort</li> <li>• „Arc-Tech“ <b>suspension</b></li> <li>• <b>CroMo</b> rails with scale</li> <li>• on Velo eurohole card</li> </ul> <b>size M:</b> <ul style="list-style-type: none"> <li>• L = 270 x W = 145 mm</li> <li>• optimal for VCZ <b>M</b> (130 - 140 mm)</li> </ul> <b>size L:</b> <ul style="list-style-type: none"> <li>• L = 270 x W = 160 mm</li> <li>• optimal for VCZ <b>L</b> (150 - 160 mm)</li> </ul> <b>size XL:</b> <ul style="list-style-type: none"> <li>• L = 270 x W = 176 mm</li> <li>• optimal for VCZ <b>XL</b> (170 - 190 mm)</li> </ul> <b>size XXL:</b> <ul style="list-style-type: none"> <li>• L = 270 x W = 190 mm</li> <li>• optimal for VCZ <b>XXL</b> (200 - 230 mm)</li> </ul>	
UVP 55,90 €			





ART.-NR.	BESCHREIBUNG	DESCRIPTION	VCZ = Velo Comfort Zone
 	<b>RENNSATTEL</b> <b>›VELO-FIT ATHLETE BC‹</b> <ul style="list-style-type: none"> <li>• "Arc-Tech" <b>gefederter</b> Stützpunkt</li> <li>• <b>"O-Zone Base Cut"</b></li> <li>• sehr <b>leichter Komfortschaum</b></li> <li>• nahtlose Oberfläche</li> <li>• auf Velo Eurolochkarte</li> </ul>	<b>RACING SADDLE</b> <b>›VELO-FIT ATHLETE BC‹</b> <ul style="list-style-type: none"> <li>• "Arc-Tech" <b>suspension</b></li> <li>• <b>"O-Zone Base Cut"</b></li> <li>• very <b>light comfort foam</b></li> <li>• seamless surface</li> <li>• on Velo eurohole card</li> </ul>	 244 g    
250520	<b>Größe S:</b> <ul style="list-style-type: none"> <li>• L = 286 x B = 134 mm</li> <li>• optimal für VCZ <b>S</b> (110 - 120 mm)</li> <li>• <b>glasfaserverstärkte</b> Schale</li> <li>• <b>CrMo</b>-Gestell mit <b>Skala</b></li> <li>• nur 244 g</li> </ul>	<b>size S:</b> <ul style="list-style-type: none"> <li>• L = 286 x W = 134 mm</li> <li>• optimal for VCZ <b>S</b> (110 - 120 mm)</li> <li>• <b>glass fiber reinforced shell</b></li> <li>• <b>CrMo</b> rails with <b>scale</b></li> <li>• only 244 g</li> </ul>	
250521	<b>Größe M:</b> <ul style="list-style-type: none"> <li>• L = 280 x B = 147 mm</li> <li>• optimal für VCZ <b>M</b> (130 - 140 mm)</li> <li>• nur 301 g</li> </ul>	<b>size M:</b> <ul style="list-style-type: none"> <li>• L = 280 x W = 147 mm</li> <li>• optimal for VCZ <b>M</b> (130 - 140 mm)</li> <li>• only 301 g</li> </ul>	
250522	<b>Größe L:</b> <ul style="list-style-type: none"> <li>• L = 277 x B = 155 mm</li> <li>• optimal für VCZ <b>L</b> (150 - 160 mm)</li> <li>• nur 317 g</li> </ul>	<b>size L:</b> <ul style="list-style-type: none"> <li>• L = 277 x W = 155 mm</li> <li>• optimal for VCZ <b>L</b> (150 - 160 mm)</li> <li>• only 317 g</li> </ul>	
250523	<b>Größe XL:</b> <ul style="list-style-type: none"> <li>• L = 275 x B = 163 mm</li> <li>• optimal für VCZ <b>XL</b> (170 - 190 mm)</li> <li>• nur 344 g</li> </ul>	<b>size XL:</b> <ul style="list-style-type: none"> <li>• L = 275 x W = 163 mm</li> <li>• optimal for VCZ <b>XL</b> (170 - 190 mm)</li> <li>• only 344 g</li> </ul>	
20			UVP 45,90 €
 	<b>RENNSATTEL</b> <b>›VELO-FIT ATHLETE FC‹</b> <ul style="list-style-type: none"> <li>• "Arc-Tech" <b>gefederter</b> Stützpunkt</li> <li>• <b>"O-Zone Full Cut"</b></li> <li>• sehr <b>leichter Komfortschaum</b></li> <li>• nahezu nahtlose Oberfläche</li> <li>• auf Velo Eurolochkarte</li> </ul>	<b>RACING SADDLE</b> <b>›VELO-FIT ATHLETE FC‹</b> <ul style="list-style-type: none"> <li>• "Arc-Tech" <b>suspension</b></li> <li>• <b>"O-Zone Full Cut"</b></li> <li>• very <b>light comfort foam</b></li> <li>• almost seamless surface</li> <li>• on Velo eurohole card</li> </ul>	 248 g    
250524	<b>Größe S:</b> <ul style="list-style-type: none"> <li>• L = 286 x B = 134 mm</li> <li>• optimal für VCZ <b>S</b> (110 - 120 mm)</li> <li>• <b>glasfaserverstärkte</b> Schale</li> <li>• <b>CrMo</b>-Gestell mit <b>Skala</b></li> <li>• nur 248 g</li> </ul>	<b>size S:</b> <ul style="list-style-type: none"> <li>• L = 286 x W = 134 mm</li> <li>• optimal for VCZ <b>S</b> (110 - 120 mm)</li> <li>• <b>glass fiber reinforced shell</b></li> <li>• <b>CrMo</b> rails with <b>scale</b></li> <li>• only 248 g</li> </ul>	
250525	<b>Größe M:</b> <ul style="list-style-type: none"> <li>• L = 276 x B = 145 mm</li> <li>• optimal für VCZ <b>M</b> (130 - 140 mm)</li> <li>• nur 290 g</li> </ul>	<b>size M:</b> <ul style="list-style-type: none"> <li>• L = 276 x W = 145 mm</li> <li>• optimal for VCZ <b>M</b> (130 - 140 mm)</li> <li>• only 290 g</li> </ul>	
250526	<b>Größe L:</b> <ul style="list-style-type: none"> <li>• L = 276 x B = 152 mm</li> <li>• optimal für VCZ <b>L</b> (150 - 160 mm)</li> <li>• nur 317 g</li> </ul>	<b>size L:</b> <ul style="list-style-type: none"> <li>• L = 276 x W = 152 mm</li> <li>• optimal for VCZ <b>L</b> (150 - 160 mm)</li> <li>• only 317 g</li> </ul>	
250527	<b>Größe XL:</b> <ul style="list-style-type: none"> <li>• L = 277 x B = 163 mm</li> <li>• optimal für VCZ <b>XL</b> (170 - 190 mm)</li> <li>• nur 335 g</li> </ul>	<b>size XL:</b> <ul style="list-style-type: none"> <li>• L = 277 x W = 163 mm</li> <li>• optimal for VCZ <b>XL</b> (170 - 190 mm)</li> <li>• only 335 g</li> </ul>	
20			UVP 53,90 €

ART.-NR.	BESCHREIBUNG	DESCRIPTION	VCZ = Velo Comfort Zone
   <b>250362</b> 	<b>TREKKING-SATTEL ›VELO-FIT TRAVELLER‹</b> <ul style="list-style-type: none"> <li>• "D2"-Konstruktion</li> <li>• "Arc-Tech" <b>gefederter</b> Stützpunkt</li> <li>• "O-Zone Base Cut"</li> <li>• sehr <b>leichter Komfortschaum</b></li> <li>• nahtlose Oberfläche</li> <li>• auf Velo Eurolochkarte</li> </ul> <p><b>Größe S:</b></p> <ul style="list-style-type: none"> <li>• L = 235 x B = 143 mm</li> <li>• optimal für VCZ <b>S</b> (110 - 120 mm)</li> <li>• ohne "D2"-Konstruktion und "O-Zone Base Cut"</li> <li>• nur 282 g</li> </ul> <p><b>Größe M:</b></p> <ul style="list-style-type: none"> <li>• L = 267 x B = 152 mm</li> <li>• optimal für VCZ <b>M</b> (130 - 140 mm)</li> <li>• nur 363 g</li> </ul> <p><b>Größe L:</b></p> <ul style="list-style-type: none"> <li>• L = 284 x B = 172 mm</li> <li>• optimal für VCZ <b>L</b> (150 - 160 mm)</li> <li>• nur 408 g</li> </ul> <p><b>Größe XL:</b></p> <ul style="list-style-type: none"> <li>• L = 260 x B = 191 mm</li> <li>• optimal für VCZ <b>XL</b> (170 - 190 mm)</li> <li>• nur 428 g</li> </ul> <p><b>Größe XXL:</b></p> <ul style="list-style-type: none"> <li>• L = 263 x B = 205 mm</li> <li>• optimal für VCZ <b>XXL</b> (200 - 230 mm)</li> <li>• nur 451 g</li> </ul>	<b>TREKKING SADDLE ›VELO-FIT TRAVELLER‹</b> <ul style="list-style-type: none"> <li>• "D2" construction</li> <li>• "Arc-Tech" <b>suspension</b></li> <li>• "O-Zone Base Cut"</li> <li>• very <b>light comfort foam</b></li> <li>• seamless surface</li> <li>• on Velo eurohole card</li> </ul> <p><b>size S:</b></p> <ul style="list-style-type: none"> <li>• L = 235 x W = 143 mm</li> <li>• optimal for VCZ <b>S</b> (110 - 120 mm)</li> <li>• without "D2" construction and "O-Zone Base Cut"</li> <li>• only 282 g</li> </ul> <p><b>size M:</b></p> <ul style="list-style-type: none"> <li>• L = 267 x W = 152 mm</li> <li>• optimal for VCZ <b>M</b> (130 - 140 mm)</li> <li>• only 363 g</li> </ul> <p><b>size L:</b></p> <ul style="list-style-type: none"> <li>• L = 284 x W = 172 mm</li> <li>• optimal for VCZ <b>L</b> (150 - 160 mm)</li> <li>• only 408 g</li> </ul> <p><b>size XL:</b></p> <ul style="list-style-type: none"> <li>• L = 260 x W = 191 mm</li> <li>• optimal for VCZ <b>XL</b> (170 - 190 mm)</li> <li>• only 428 g</li> </ul> <p><b>size XXL:</b></p> <ul style="list-style-type: none"> <li>• L = 263 x W = 205 mm</li> <li>• optimal for VCZ <b>XXL</b> (200 - 230 mm)</li> <li>• only 451 g</li> </ul> <p>UVP 39,90 €</p>	 282 g    <b>S</b> <b>M</b> <b>L</b> <b>XL</b> <b>XXL</b> 
   <b>250532</b>	<b>CITY-/ KOMFORTSATTEL ›VELO-FIT TOWNIE‹</b> <ul style="list-style-type: none"> <li>• "D2"-Konstruktion</li> <li>• sehr <b>leichter Komfortschaum</b></li> <li>• <b>Elastomer Federung</b></li> <li>• auf Velo Eurolochkarte</li> </ul> <p><b>Größe M:</b></p> <ul style="list-style-type: none"> <li>• „O-Zone Base Cut“</li> <li>• L = 270 x B = 180 mm</li> <li>• optimal für VCZ <b>M</b> (130 - 140 mm)</li> <li>• nur 566 g</li> </ul> <p><b>Größe L:</b></p> <ul style="list-style-type: none"> <li>• „O-Zone Base Cut“</li> <li>• L = 268 x B = 199 mm</li> <li>• optimal für VCZ <b>L</b> (150 - 160 mm)</li> <li>• nur 623 g</li> </ul> <p><b>Größe XL:</b></p> <ul style="list-style-type: none"> <li>• L = 263 x B = 216 mm</li> <li>• optimal für VCZ <b>XL</b> (170 - 190 mm)</li> <li>• nur 719 g</li> </ul> <p><b>Größe XXL:</b></p> <ul style="list-style-type: none"> <li>• L = 267 x B = 238 mm</li> <li>• optimal für VCZ <b>XXL</b> (200 - 230 mm)</li> <li>• nur 765 g</li> </ul>	<b>CITY / COMFORT SADDLE ›VELO-FIT TOWNIE‹</b> <ul style="list-style-type: none"> <li>• "D2" construction</li> <li>• very <b>light comfort foam</b></li> <li>• <b>elastomer suspension</b></li> <li>• on Velo eurohole card</li> </ul> <p><b>size M:</b></p> <ul style="list-style-type: none"> <li>• „O-Zone Base Cut“</li> <li>• L = 270 x W = 180 mm</li> <li>• optimal for VCZ <b>M</b> (130 - 140 mm)</li> <li>• only 566 g</li> </ul> <p><b>size L:</b></p> <ul style="list-style-type: none"> <li>• „O-Zone Base Cut“</li> <li>• L = 268 x W = 199 mm</li> <li>• optimal for VCZ <b>L</b> (150 - 160 mm)</li> <li>• only 623 g</li> </ul> <p><b>size XL:</b></p> <ul style="list-style-type: none"> <li>• L = 263 x W = 216 mm</li> <li>• optimal for VCZ <b>XL</b> (170 - 190 mm)</li> <li>• only 719 g</li> </ul> <p><b>size XXL:</b></p> <ul style="list-style-type: none"> <li>• L = 267 x W = 238 mm</li> <li>• optimal for VCZ <b>XXL</b> (200 - 230 mm)</li> <li>• only 765 g</li> </ul> <p>UVP 57,90 €</p>	 566 g    <b>M</b> <b>L</b> <b>XL</b> <b>XXL</b> 

ART.-NR.	BESCHREIBUNG	DESCRIPTION	
<b>COMPETITION</b>			
250274 20	<b>RENNSÄTTEL</b> <b>›AIRTHRU GEL‹</b> Rennsattel mit genialer Komfort-technologie: <ul style="list-style-type: none"> <li>• <b>Sattelschale</b> und <b>Bezug perforiert</b> für optimale Belüftung</li> <li>• hoher Fahrkomfort durch weiches <b>Honeycomb-Gel</b></li> <li>• <b>Vibrationsabsorbierung</b> durch <b>Crossbow Suspension</b></li> <li>• <b>Net-Tech Druckentlastung</b></li> <li>• <b>CrMo</b>-Gestell mit Skala</li> <li>• Einsatzzweck: Rennrad, MTB, Triathlon, Multisport</li> <li>• nur 268 g</li> <li>• L = 273 x B = 141 mm</li> <li>• auf Velo Eurolochkarte</li> </ul>	<b>RACING SADDLE</b> <b>›AIRTHRU GEL‹</b> Racing saddle with ingenious comfort technology: <ul style="list-style-type: none"> <li>• <b>saddle base and cover perforated</b> for best ventilation</li> <li>• high riding comfort through soft <b>Honeycomb gel</b></li> <li>• <b>vibration absorption</b> by <b>Crossbow suspension</b></li> <li>• <b>Net Tech pressure relief</b></li> <li>• <b>CrMo</b> rails with scale</li> <li>• usage: road racing, MTB, triathlon, multisports</li> <li>• only 268 g</li> <li>• L = 273 x W = 141 mm</li> <li>• on Velo eurohole card</li> </ul>	 <p><b>GEL</b></p>  <p><b>CROSSBOW</b></p>  <p><b>AIR-COOL</b></p>  <p><b>NET-TECH PRESSURE RELIEF</b></p>  <p>Universalkarte Art. 083141</p>
250225 20	<b>RENNSÄTTEL</b> <b>›SPEEDFLEX VACU FC‹</b> <ul style="list-style-type: none"> <li>• sportlich und haltbar dank <b>Vakuum-Technologie</b>: verschweißte, <b>wasserdichte und nahtlose</b> Oberfläche</li> <li>• Gestell mit <b>Skala</b></li> <li>• "Arc-Tech" <b>gefederter</b> Stützpunkt</li> <li>• komfortable, aber leichte Schaum- und <b>Gel</b>-Einlage</li> <li>• <b>"O-Zone Full Cut"</b></li> <li>• nur 346 g</li> <li>• L = 269 x B = 143 mm</li> <li>• auf Velo Eurolochkarte</li> </ul>	<b>RACING SADDLE</b> <b>›SPEEDFLEX VACU FC‹</b> <ul style="list-style-type: none"> <li>• sportive and durable thanks to <b>Vacuum Technology</b>: welded, <b>waterproof and seamless</b> surface</li> <li>• rails with <b>scale</b></li> <li>• "Arc-Tech" <b>suspension</b></li> <li>• comfortable, but light foam and <b>gel</b> inlay</li> <li>• <b>"O-Zone Full Cut"</b></li> <li>• only 346 g</li> <li>• L = 269 x W = 143 mm</li> <li>• on Velo eurohole card</li> </ul>	<p><b>GEL</b></p>    
250188 20	<b>RENNSÄTTEL</b> <b>›SPEEDFLEX AC‹</b> <b>Anatomisch geformter Rennsattel mit Full Cut</b> für effektive Druckentlastung und <b>Air Channel Belüftung</b> zum <b>attraktiven Preis</b> . <ul style="list-style-type: none"> <li>• Gestell mit <b>Skala</b></li> <li>• "Arc-Tech" <b>gefederter</b> Stützpunkt</li> <li>• <b>"V-Cut"</b>-Design</li> <li>• <b>"O-Zone Full Cut"</b></li> <li>• "Air Channel" <b>Luftstromkühlung</b></li> <li>• Einsatzzweck: Rennrad, Triathlon, MTB</li> <li>• nur 276 g</li> <li>• L = 275 x B = 130 mm</li> <li>• auf Velo Eurolochkarte</li> </ul>	<b>RACING SADDLE</b> <b>›SPEEDFLEX AC‹</b> <b>Anatomically shaped racing saddle with Full Cut</b> for effective pressure relief and <b>Air Channel ventilation</b> at an <b>attractive price</b> . <ul style="list-style-type: none"> <li>• rails with <b>scale</b></li> <li>• "Arc-Tech" <b>suspension</b></li> <li>• <b>"V-Cut"</b> design</li> <li>• <b>"O-Zone Full Cut"</b></li> <li>• "Air Channel" <b>ventilation</b></li> <li>• usage: road racing, triathlon, MTB</li> <li>• only 276 g</li> <li>• L = 275 x W = 130 mm</li> <li>• on Velo eurohole card</li> </ul>	  <p><b>AIR-COOL</b></p>  <p><b>AIR-COOL</b></p>  



ART.-NR.	BESCHREIBUNG	DESCRIPTION	
<p><b>250215</b></p> <p>20</p>	<p><b>RENNSATTEL ›FLEX PRO‹</b></p> <p>Die Velo Plush ProPotion Serie kombiniert in hervorragender Weise eine leicht sportlich, aber komfortable Sattelform, sinnvolle Ausstattungsmerkmale, niedriges Gewicht mit einem attraktiven Preis.</p> <ul style="list-style-type: none"> <li>• Gestell mit <b>Skala</b></li> <li>• "Arc-Tech" <b>gefederter</b> Stützpunkt</li> <li>• <b>"O-Zone Base Cut"</b></li> <li>• <b>"D2"-Net-Tech Gel</b> Konstruktion</li> <li>• <b>Druckentlastung</b> durch kleinere Kontaktfläche</li> <li>• Einsatzzweck: Trekking, MTB, Universal</li> <li>• nur 363 g</li> <li>• L = 263 x B = 158 mm</li> <li>• auf Velo Plush Eurolochkarte</li> </ul> 	<p><b>RACING SADDLE ›FLEX PRO‹</b></p> <p>The Velo Plush ProPotion Series combines in a fantastic way a slightly sportive, but comfortable saddle shape, useful details, low weight with an attractive price.</p> <ul style="list-style-type: none"> <li>• rails with <b>scale</b></li> <li>• "Arc-Tech" <b>suspension</b></li> <li>• <b>"O-Zone Base Cut"</b></li> <li>• <b>"D2" Net-Tech gel</b> construction</li> <li>• <b>pressure relief</b> through minimized saddle contact</li> <li>• usage: trekking, MTB, universal</li> <li>• only 363 g</li> <li>• L = 263 x W = 158 mm</li> <li>• on Velo Plush eurohole card</li> </ul> <p style="text-align: right;">UVP 38,90 €</p>	<p><b>Plush</b> A Philosophy of Comfort</p> 
<p><b>250196</b></p> <p>20</p>	<p><b>SATTEL ›FLEX‹</b></p> <ul style="list-style-type: none"> <li>• <b>sportliches Aussehen</b>, aber trotzdem <b>sehr bequem</b></li> <li>• "Arc-Tech" <b>gefederter</b> Stützpunkt</li> <li>• <b>"V-Cut"</b>-Design</li> <li>• <b>"O-Zone Base Cut"</b></li> <li>• seitlicher, vorderer und hinterer <b>Abriebschutz</b></li> <li>• nur 376 g</li> <li>• L = 260 x B = 152 mm</li> <li>• auf Velo Eurolochkarte</li> </ul> 	<p><b>SADDLE ›FLEX‹</b></p> <ul style="list-style-type: none"> <li>• <b>sporty look</b>, but also <b>very comfortable</b></li> <li>• "Arc-Tech" <b>suspension</b></li> <li>• <b>"V-Cut"</b> design</li> <li>• <b>"O-Zone Base Cut"</b></li> <li>• front, rear and side <b>abrasion protection</b></li> <li>• only 376 g</li> <li>• L = 260 x W = 152 mm</li> <li>• on Velo eurohole card</li> </ul> <p style="text-align: right;">UVP 27,90 €</p>	
<p><b>SATTEL ›SPEEDFLEX BASIC‹</b></p> <p><b>Original Velo Sättel zum unschlagbaren Preis!</b></p> <ul style="list-style-type: none"> <li>• Gestell mit Skala</li> <li>• formbeständiger Spezialschaum</li> <li>• <b>nahtlose Oberfläche</b></li> <li>• <b>"O-Zone Base Cut"</b> zur Druckentlastung</li> <li>• Einsatzbereich: Rennrad, Fitnessbike, MTB, Cyclocross, ....</li> <li>• Montageverpackung</li> </ul> <ul style="list-style-type: none"> <li>• <b>250453</b> • Größe S • L = 278 x B = 142 mm</li> <li>• <b>250454</b> • Größe M • L = 274 x B = 146 mm</li> <li>• <b>250455</b> • Größe L • L = 277 x B = 157 mm</li> </ul> <p>20</p> 	<p><b>SADDLE ›SPEEDFLEX BASIC‹</b></p> <p><b>Original Velo saddles at an unbeatable price!</b></p> <ul style="list-style-type: none"> <li>• rails with scale</li> <li>• memory foam</li> <li>• <b>seamless surface</b></li> <li>• <b>"O-Zone Base Cut"</b> for the pressure discharge</li> <li>• usage: road racing, fitness bike, MTB, Cyclocross, ...</li> <li>• OEM</li> </ul> <ul style="list-style-type: none"> <li>• size S • L = 278 x W = 142 mm</li> <li>• size M • L = 274 x W = 146 mm</li> <li>• size L • L = 277 x W = 157 mm</li> </ul> <p style="text-align: right;">UVP 25,90 €</p>	<p><b>S</b> <b>BASIC</b></p> <p><b>M</b></p> <p><b>L</b></p> 	

ART.-NR.	BESCHREIBUNG	DESCRIPTION	
<b>TOUR</b>			
	<b>SATTEL ›PLUSH GEL D2‹</b>	<b>SADDLE ›PLUSH GEL D2‹</b>	<b>GEL</b>
	<ul style="list-style-type: none"> <li>• <b>Aluminium-Look</b>-Gestell</li> <li>• "Arc-Tech" <b>gedeifter</b> Stützpunkt</li> <li>• "<b>O-Zone Full Cut</b>"</li> <li>• "<b>D2</b>"-Konstruktion</li> <li>• <b>anatomische Form</b> durch "<b>Deep Channel</b>"-Design</li> <li>• mit <b>Gel-Einlage</b></li> <li>• <b>Vacuum-Technologie</b>: verschweißte, wasserdichte und nahtlose Oberfläche</li> <li>• auf Velo Eurolochkarte</li> </ul>	<ul style="list-style-type: none"> <li>• <b>aluminium look rails</b></li> <li>• "Arc-Tech" <b>suspension</b></li> <li>• "<b>O-Zone Full Cut</b>"</li> <li>• "<b>D2</b>" construction</li> <li>• <b>anatomic shape</b> by "<b>Deep Channel</b>" design</li> <li>• with <b>gel inlay</b></li> <li>• <b>Vacuum Technology</b>: welded, waterproof and seamless surface</li> <li>• on Velo eurohole card</li> </ul>	
<b>250245</b> 20	<ul style="list-style-type: none"> <li>• L = 267 x B = 168 mm</li> <li>• nur 494 g</li> </ul>	<ul style="list-style-type: none"> <li>• L = 267 x W = 168 mm</li> <li>• only 494 g</li> </ul>	UVP 41,90 €
<b>250246</b> 20	<ul style="list-style-type: none"> <li>• L = 255 x B = 177 mm</li> <li>• nur 477 g</li> </ul>	<ul style="list-style-type: none"> <li>• L = 255 x W = 177 mm</li> <li>• only 477 g</li> </ul>	UVP 41,90 €
	<b>SATTEL ›PLUSH GEL D1‹</b>	<b>SADDLE ›PLUSH GEL D1‹</b>	<b>GEL</b>
	<ul style="list-style-type: none"> <li>• <b>Aluminium-Look</b>-Gestell</li> <li>• "Arc-Tech" <b>gedeifter</b> Stützpunkt</li> <li>• "<b>O-Zone Full Cut</b>"</li> <li>• <b>anatomische Form</b> durch "<b>Deep Channel</b>"-Design</li> <li>• <b>Gel-Einlage</b></li> <li>• <b>Vacuum-Technologie</b>: verschweißte, wasserdichte und nahtlose Oberfläche</li> <li>• Montageverpackung</li> </ul>	<ul style="list-style-type: none"> <li>• <b>aluminium look rails</b></li> <li>• "Arc-Tech" <b>suspension</b></li> <li>• "<b>O-Zone Full Cut</b>"</li> <li>• <b>anatomic shape</b> by "<b>Deep Channel</b>" design</li> <li>• <b>gel inlay</b></li> <li>• <b>Vacuum Technology</b>: welded, waterproof and seamless surface</li> <li>• OEM</li> </ul>	
<b>250242</b> 20	<ul style="list-style-type: none"> <li>• L = 267 x B = 168 mm</li> <li>• nur 485 g</li> </ul>	<ul style="list-style-type: none"> <li>• L = 267 x W = 168 mm</li> <li>• only 485 g</li> </ul>	UVP 36,90 €
<b>250243</b> 20	<ul style="list-style-type: none"> <li>• L = 254 x B = 173 mm</li> <li>• nur 459 g</li> </ul>	<ul style="list-style-type: none"> <li>• L = 254 x W = 173 mm</li> <li>• only 459 g</li> </ul>	UVP 36,90 €



ART.-NR. 	BESCHREIBUNG	DESCRIPTION	
250175 20	<b>SATTEL ›FLEX DC‹</b> <ul style="list-style-type: none"> <li>• "Arc-Tech" <b>gefederter</b> Stützpunkt</li> <li>• "D2"-Konstruktion</li> <li>• "Deep Channel"-Design</li> <li>• "O-Zone Full Cut"</li> <li>• mit <b>Luftstromkühlung</b></li> <li>• auf Velo Plush Eurolochkarte</li> </ul>	<b>SADDLE ›FLEX DC‹</b> <ul style="list-style-type: none"> <li>• "Arc-Tech" <b>suspension</b></li> <li>• "D2" construction</li> <li>• "Deep Channel" design</li> <li>• "O-Zone Full Cut"</li> <li>• with "Airthru cool"</li> <li>• on Velo Plush eurohole card</li> </ul>	  <p><b>Plush</b> A Philosophy of Comfort</p> <p><b>AIR-COOL</b></p> <p>UVP 43,90 €</p>
250176 10	<ul style="list-style-type: none"> <li>• L = 242 x B = 151 mm</li> <li>• nur 386 g</li> </ul> 	<ul style="list-style-type: none"> <li>• L = 242 x W = 151 mm</li> <li>• only 386 g</li> </ul>	 <p><b>AIR-COOL</b></p> <p>UVP 43,90 €</p>
250198 20	<b>SATTEL ›BASIC DEEP CHANNEL‹</b> <ul style="list-style-type: none"> <li>• "Arc-Tech" <b>gefederter</b> Stützpunkt</li> <li>• "D2"-Konstruktion</li> <li>• "Deep Channel"-Design</li> <li>• "O-Zone Full Cut"</li> <li>• mit <b>Luftstromkühlung</b></li> <li>• auf Velo Eurolochkarte</li> </ul>	<b>SADDLE ›BASIC DEEP CHANNEL‹</b> <ul style="list-style-type: none"> <li>• "Arc-Tech" <b>suspension</b></li> <li>• "D2" construction</li> <li>• "Deep Channel" design</li> <li>• "O-Zone Full Cut"</li> <li>• with "Airthru cool"</li> <li>• on Velo eurohole card</li> </ul>	  <p>Empfohlen von <b>aktivi Rad fahren</b></p> <p><b>AIR-COOL</b></p> <p>UVP 36,90 €</p>
250199 20	<ul style="list-style-type: none"> <li>• L = 243 x B = 155 mm</li> <li>• nur 387 g</li> </ul> 	<ul style="list-style-type: none"> <li>• L = 243 x W = 155 mm</li> <li>• only 387 g</li> </ul>	 <p><b>AIR-COOL</b></p> <p>UVP 36,90 €</p>
250336 250338 20	<b>SATTEL ›WIDE:CHANNEL‹</b> <p>Die <b>wide:channel</b>-Serie bietet durch die "Kreuzung" von "<b>Wide Channel</b>" und "<b>O-Zone Full Cut</b>" eine im Genitalbereich besonders breite und lange Mittelrinne, die einen wichtigen Beitrag zur Druckentlastung leistet.</p> <ul style="list-style-type: none"> <li>• "Arc-Tech" <b>gefederter</b> Stützpunkt</li> <li>• "D2"-Konstruktion</li> <li>• "<b>O-Zone Full Cut</b>" und "<b>Wide Channel</b>"</li> <li>• mit <b>Luftstromkühlung</b></li> <li>• <b>nahtloses</b> Obermaterial</li> <li>• auf Velo Eurolochkarte</li> </ul> <ul style="list-style-type: none"> <li>• L = 270 x B = 175 mm</li> <li>• nur 358 g</li> </ul>	<b>SADDLE ›WIDE:CHANNEL‹</b> <p><b>wide:channel</b> series is a mixture of "<b>Wide Channel</b>" and "<b>O-Zone Full Cut</b>". Therefore a very wide and long groove is created in the genitalia area, which can make a considerable contribution to pressure relief.</p> <ul style="list-style-type: none"> <li>• "Arc-Tech" <b>suspension</b></li> <li>• "D2" construction</li> <li>• "<b>O-Zone Full Cut</b>" and "<b>Wide Channel</b>"</li> <li>• with "<b>Airthru cool</b>"</li> <li>• <b>seamless</b> cover material</li> <li>• on Velo eurohole card</li> </ul> <ul style="list-style-type: none"> <li>• L = 270 x W = 175 mm</li> <li>• only 358 g</li> </ul>	  <p><b>AIR-COOL</b></p> <p>UVP 45,90 €</p>
250337 250339 20	<ul style="list-style-type: none"> <li>• L = 250 x B = 168 mm</li> <li>• nur 318 g</li> </ul>	<ul style="list-style-type: none"> <li>• L = 250 x W = 168 mm</li> <li>• only 318 g</li> </ul>	 <p><b>AIR-COOL</b></p> <p>UVP 41,90 €</p>



ART.-NR. 	BESCHREIBUNG	DESCRIPTION	
<b>250365</b> 20	<b>SATTEL ›TOUR E-GRIP‹</b> <b>Bequemer Tourensattel mit Griff</b> hinten zum <b>einfachen Abstellen</b> auf Doppelbein­ständer, z. B. <b>E-Bikes</b> , ...  <ul style="list-style-type: none"> <li>• "D2"-Konstruktion</li> <li>• "O-Zone Base Cut"</li> <li>• vorderer und hinterer <b>Abriebschutz</b></li> <li>• Einsatzzweck: E-Bike, Freizeit, Fitness</li> <li>• auf Velo Plush Eurolochkarte</li> </ul>	<b>SADDLE ›TOUR E-GRIP‹</b> <b>Comfortable touring saddle</b> with <b>handle</b> at the back for <b>easy parking</b> of double leg stands, e. g. <b>E-bikes</b> , ...  <ul style="list-style-type: none"> <li>• "D2" construction</li> <li>• "O-Zone Base Cut"</li> <li>• front and rear <b>abrasion protection</b></li> <li>• usage: E-Bike, sportive, fitness</li> <li>• on Velo Plush eurohole card</li> </ul>	
<b>250366</b> 20	<ul style="list-style-type: none"> <li>• L = 272 x B = 212 mm</li> <li>• nur 498 g</li> </ul>	<ul style="list-style-type: none"> <li>• L = 272 x W = 212 mm</li> <li>• only 498 g</li> </ul>	
<b>250291</b> 10	<b>SATTEL ›TOUR HC GEL‹</b> <ul style="list-style-type: none"> <li>• "Arc-Tech" <b>gedfederter</b> Stützpunkt</li> <li>• super-komfortable, aber leichte <b>Honeycomb-Gel</b>-Einlage</li> <li>• "O-Zone Base Cut"</li> <li>• vorderer und hinterer <b>Abriebschutz</b></li> <li>• Einsatzzweck: Freizeit, Fitness</li> <li>• nur 463 g</li> <li>• L = 260 x B = 168 mm</li> <li>• auf Velo Plush Eurolochkarte</li> </ul>	<b>SADDLE ›TOUR HC GEL‹</b> <ul style="list-style-type: none"> <li>• "Arc-Tech" <b>suspension</b></li> <li>• super-comfortable, but light <b>honeycomb gel</b> inlay</li> <li>• "O-Zone Base Cut"</li> <li>• front and rear <b>abrasion protection</b></li> <li>• usage: sportive, fitness</li> <li>• only 463 g</li> <li>• L = 260 x W = 168 mm</li> <li>• on Velo Plush eurohole card</li> </ul>	<b>HONEYCOMB-GEL</b> <b>Plush</b> A Philosophy of Comfort. 
<b>250190</b> 20	<b>SATTEL ›TOUR UNI‹</b> <ul style="list-style-type: none"> <li>• "Arc-Tech" <b>gedfederter</b> Stützpunkt</li> <li>• <b>sehr bequem</b> durch "D2"-Konstruktion</li> <li>• "O-Zone Base Cut"</li> <li>• <b>erhöhte Polsterung</b> hinten, für <b>druckfreie Sitzposition</b> im vorderen Bereich</li> <li>• vorderer, hinterer und seitlicher <b>Abriebschutz</b></li> <li>• <b>universell für Damen und Herren</b></li> <li>• nur 398 g</li> <li>• L = 261 x B = 161 mm</li> <li>• auf Velo Plush Eurolochkarte</li> </ul>	<b>SADDLE ›TOUR UNI‹</b> <ul style="list-style-type: none"> <li>• "Arc-Tech" <b>suspension</b></li> <li>• <b>very comfortable</b> because of "D2" construction</li> <li>• "O-Zone Base Cut"</li> <li>• <b>higher padding</b> rear, for <b>comfortable seat position without pressure</b> in the front</li> <li>• side, front and rear <b>abrasion protection</b></li> <li>• <b>universal for ladies and gents</b></li> <li>• only 398 g</li> <li>• L = 261 x W = 161 mm</li> <li>• on Velo Plush eurohole card</li> </ul>	



ART.-NR.	BESCHREIBUNG	DESCRIPTION	
<p>250213</p> <p>20</p>	<p><b>SATTEL ›TOUR L2 ECO‹</b></p> <ul style="list-style-type: none"> <li>• nahtloses Obermaterial</li> <li>• "D2"-Konstruktion</li> <li>• "O-Zone Base Cut"</li> <li>• seitlicher und hinterer <b>Abriebschutz</b></li> <li>• nur 389 g</li> <li>• L = 252 x B = 190 mm</li> <li>• auf Velo Eurolochkarte</li> </ul>	<p><b>SADDLE ›TOUR L2 ECO‹</b></p> <ul style="list-style-type: none"> <li>• seamless surface</li> <li>• "D2" construction</li> <li>• "O-Zone Base Cut"</li> <li>• side and rear <b>abrasion protection</b></li> <li>• only 389 g</li> <li>• L = 252 x W = 190 mm</li> <li>• on Velo eurohole card</li> </ul>	<p>UVP 31,90 €</p>
<p>• 250539</p> <p>• 250540</p> <p>• 250541</p> <p>20</p>	<p><b>SATTEL ›TOUR BASIC‹</b></p> <p><b>Original Velo Sättel zum unschlagbaren Preis!</b></p> <ul style="list-style-type: none"> <li>• "Arc-Tech" <b>gefederter</b> Stützpunkt</li> <li>• Gestell mit Skala</li> <li>• "O-Zone Base Cut"</li> <li>• sehr <b>leichter Komfortschaum</b></li> <li>• auf Velo Eurolochkarte</li> </ul> <p><b>Größe S:</b></p> <ul style="list-style-type: none"> <li>• L = 267 x B = 167 mm</li> <li>• nur 428 g</li> </ul> <p><b>Größe M:</b></p> <ul style="list-style-type: none"> <li>• L = 280 x B = 183 mm</li> <li>• nur 431 g</li> </ul> <p><b>Größe L:</b></p> <ul style="list-style-type: none"> <li>• L = 267 x B = 201 mm</li> <li>• nur 439 g</li> </ul>	<p><b>SADDLE ›TOUR BASIC‹</b></p> <p><b>Original Velo saddles at an unbeatable price!</b></p> <ul style="list-style-type: none"> <li>• "Arc-Tech" <b>suspension</b></li> <li>• rails with scale</li> <li>• "O-Zone Base Cut"</li> <li>• very <b>light comfort foam</b></li> <li>• on Velo eurohole card</li> </ul> <p><b>size S:</b></p> <ul style="list-style-type: none"> <li>• L = 267 x W = 167 mm</li> <li>• only 428 g</li> </ul> <p><b>size M:</b></p> <ul style="list-style-type: none"> <li>• L = 280 x W = 183 mm</li> <li>• only 431 g</li> </ul> <p><b>size L:</b></p> <ul style="list-style-type: none"> <li>• L = 267 x W = 201 mm</li> <li>• only 439 g</li> </ul>	<p><b>BASIC</b></p> <p>UVP 31,90 €</p>
<b>CITY</b>			
<p>250126</p> <p>10</p>	<p><b>SATTEL ›TOUR AIR-LASTOMER‹</b></p> <p>Durch das <b>patentierte</b> "Air-Lastomer"-System ist der <b>Luftdruck</b> in der Satteldecke und somit die <b>Weichheit</b> des Sattels, auch <b>während der Fahrt</b>, mit der <b>integrierten Pumpe</b> <b>verstellbar</b>.</p> <ul style="list-style-type: none"> <li>• zusätzlicher Komfort durch <b>Elastomer-Shock-Absorbing</b></li> <li>• "Arc-Tech" <b>gefederter</b> Stützpunkt</li> <li>• "O-Zone Base Cut"</li> <li>• seitlicher, hinterer und vorderer <b>Abriebschutz</b></li> <li>• nur 665 g</li> <li>• L = 270 x B = 180 mm</li> <li>• auf Velo Plush Eurolochkarte</li> </ul>	<p><b>SADDLE ›TOUR AIR-LASTOMER‹</b></p> <p>The <b>air pressure</b> in the saddle cover can be adjusted by the <b>patented</b> "Air-Lastomer" system. Thus, the <b>softness</b> of the saddle can be <b>changed</b> even <b>when you are riding</b>, by the <b>integrated pump</b>.</p> <ul style="list-style-type: none"> <li>• additional comfort by <b>Elastomer-Shock-Absorbing</b></li> <li>• "Arc-Tech" <b>suspension</b></li> <li>• "O-Zone Base Cut"</li> <li>• side, rear and front <b>abrasion protection</b></li> <li>• only 665 g</li> <li>• L = 270 x W = 180 mm</li> <li>• on Velo Plush eurohole card</li> </ul>	<p><b>Plush</b> A Philosophy of Comfort</p> <p>UVP 61,90 €</p>

ART.-NR.	BESCHREIBUNG	DESCRIPTION	
<b>250110</b> 12	<b>SATTEL ›TOUR AIR LASTOMER II‹</b> Das eingebaute <b>Luftpolster</b> kann mit einer Luftpumpe schnell und unkompliziert individuell <b>eingestellt</b> werden. <ul style="list-style-type: none"> <li>• "Arc-Tech" <b>gefederter</b> Stützpunkt</li> <li>• zusätzlicher Komfort durch <b>Elastomer-Shock-Absorbing</b></li> <li>• Druckentlastung durch <b>Net-Tech-Base</b></li> <li>• <b>"O-Zone Base Cut"</b></li> <li>• nur <b>665 g!</b></li> <li>• L = 272 x B = 210 mm</li> <li>• auf Velo Plush Eurolochkarte</li> </ul>	<b>SADDLE ›TOUR AIR LASTOMER II‹</b> The saddle <b>softness</b> can be individually <b>adjusted</b> through the integrated valve by pumping up the <b>air pad</b> . <ul style="list-style-type: none"> <li>• "Arc-Tech" <b>suspension</b></li> <li>• additional comfort by <b>Elastomer-Shock-Absorbing</b></li> <li>• pressure relief by <b>Net-Tech-Base</b></li> <li>• <b>"O-Zone Base Cut"</b></li> <li>• only <b>665 g!</b></li> <li>• L = 272 x W = 210 mm</li> <li>• on Velo Plush eurohole card</li> </ul>	
<b>250349</b> 5	<b>SATTEL ›NEWPORT GEMINI‹</b> <ul style="list-style-type: none"> <li>• mit <b>Memory Foam</b>: der Sattel passt sich schnell der individuellen Gesäßform an</li> <li>• mit <b>Elastomer-Shock-Absorbing</b> und Kinderschutz</li> <li>• "Arc-Tech" <b>gefederter</b> Stützpunkt</li> <li>• sehr bequemer Komfort-Sattel durch <b>"D2"</b>-Konstruktion</li> <li>• <b>"O-Zone Full Cut"</b></li> <li>• schwarz/grau/weiß</li> <li>• auf Velo Eurolochkarte</li> </ul>	<b>SADDLE ›NEWPORT GEMINI‹</b> <ul style="list-style-type: none"> <li>• with <b>Memory Foam</b>: fast adaption of the saddle cover to the buttocks shape</li> <li>• with <b>Elastomer-Shock-Absorbing</b> and child protection</li> <li>• "Arc-Tech" <b>suspension</b></li> <li>• very comfortable saddle by <b>"D2"</b> construction</li> <li>• <b>"O-Zone Full Cut"</b></li> <li>• black/grey/white</li> <li>• on Velo eurohole card</li> </ul>	
<b>250350</b> 10	<ul style="list-style-type: none"> <li>• L = 245 x B = 212 mm</li> <li>• nur ca. 685 g durch Spezialschaum</li> </ul>	<ul style="list-style-type: none"> <li>• L = 245 x W = 212 mm</li> <li>• only approx. 685 g by special foam</li> </ul>	
<b>250352</b> 10	<b>SATTEL ›PLUSH ELASTO MF‹</b> <ul style="list-style-type: none"> <li>• <b>Aluminium-Look-Gestell</b></li> <li>• mit <b>Elastomer-Shock-Absorbing</b></li> <li>• "Arc-Tech" <b>gefederter</b> Stützpunkt</li> <li>• <b>"D2"</b>-Konstruktion</li> <li>• <b>"O-Zone Base Cut"</b></li> <li>• <b>anatomische Form</b> durch <b>"Deep Channel"</b>-Design</li> <li>• <b>Memory foam</b></li> <li>• <b>Vacuum-Technologie</b>: verschweißte, wasserdichte und nahtlose Oberfläche</li> <li>• L = 275 x B = 211 mm</li> <li>• auf Velo Eurolochkarte</li> </ul>	<b>SADDLE ›PLUSH ELASTO MF‹</b> <ul style="list-style-type: none"> <li>• <b>aluminium look rails</b></li> <li>• with <b>Elastomer Shock Absorbing</b></li> <li>• "Arc-Tech" <b>suspension</b></li> <li>• <b>"D2"</b> construction</li> <li>• <b>"O-Zone Base Cut"</b></li> <li>• <b>anatomic shape</b> by <b>"Deep Channel"</b> design</li> <li>• <b>memory foam</b></li> <li>• <b>Vacuum Technology</b>: welded, waterproof and seamless surface</li> <li>• L = 275 x W = 211 mm</li> <li>• on Velo eurohole card</li> </ul>	

ART.-NR. 	BESCHREIBUNG	DESCRIPTION	
<b>250347</b> 10	<b>SATTEL ›PLUSH GEL ELASTO‹</b> <ul style="list-style-type: none"> <li>• <b>Aluminium-Look-Gestell</b></li> <li>• mit <b>Elastomer-Shock-Absorbing</b></li> <li>• "Arc-Tech" <b>gefederter</b> Stützpunkt</li> <li>• "D2"-Konstruktion</li> <li>• "<b>O-Zone Full Cut</b>"</li> <li>• <b>anatomische Form</b> durch "<b>Deep Channel</b>"-Design</li> <li>• <b>Gel-Einlage</b></li> <li>• <b>Vacuum-Technologie:</b> verschweißte, wasserdichte und nahtlose Oberfläche</li> <li>• auf Velo Eurolochkarte</li> </ul>	<b>SADDLE ›PLUSH GEL ELASTO‹</b> <ul style="list-style-type: none"> <li>• <b>aluminium look rails</b></li> <li>• with <b>Elastomer Shock Absorbing</b></li> <li>• "Arc-Tech" <b>suspension</b></li> <li>• "D2" construction</li> <li>• "<b>O-Zone Full Cut</b>"</li> <li>• <b>anatomic shape</b> by "Deep Channel" design</li> <li>• <b>gel inlay</b></li> <li>• <b>Vacuum Technology:</b> welded, waterproof and seamless surface</li> <li>• on Velo eurohole card</li> </ul>	<div data-bbox="1182 232 1262 255" style="border: 1px solid black; padding: 2px; display: inline-block;">GEL</div> 
<b>250348</b> 10	L = 254 x B = 200 mm	L = 254 x W = 200 mm	
		UVP 53,90 €	
<b>250271</b> 10	<b>SATTEL ›SAFETY‹</b> <ul style="list-style-type: none"> <li>• mit <b>Elastomer-Shock-Absorbing</b></li> <li>• "Arc-Tech" <b>gefederter</b> Stützpunkt</li> <li>• "<b>O-Zone Base Cut</b>"</li> <li>• <b>anatomisch</b> geformt</li> <li>• mit <b>Abriebschutz</b> rundum</li> <li>• mit Sattelstützklemme</li> <li>• nur 829 g durch Verwendung eines leichten Spezialschaums</li> <li>• L = 265 x B = 240 mm</li> <li>• auf Velo Eurolochkarte</li> </ul>	<b>SADDLE ›SAFETY‹</b> <ul style="list-style-type: none"> <li>• with <b>Elastomer Shock Absorbing</b></li> <li>• "Arc-Tech" <b>suspension</b></li> <li>• "<b>O-Zone Base Cut</b>"</li> <li>• <b>anatomically</b> shaped</li> <li>• <b>abrasion protection</b> on all sides</li> <li>• with clamp for seat post</li> <li>• only 829 g because of using a light foam</li> <li>• L = 265 x W = 240 mm</li> <li>• on Velo eurohole card</li> </ul>	
		Reflektor ohne deutsches Prüfzeichen - Verkauf und Nutzung im Geltungsbereich der StVZO (Deutschland) unzulässig (Abgabe nur an außerdeutsche Kunden).	UVP 55,90 €
<b>250068</b> 10	<b>SATTEL ›ELASTO GRIP‹</b> <ul style="list-style-type: none"> <li>• mit <b>Griff</b> hinten zum <b>einfachen Abstellen</b> auf Doppelbeinständern, z. B. E-Bikes, ...</li> <li>• mit <b>Elastomer-Shock-Absorbing</b> und <b>Kinderschutz</b></li> <li>• "Arc-Tech" <b>gefederter</b> Stützpunkt</li> <li>• seitlicher und hinterer <b>Abriebschutz</b></li> <li>• nur 725 g</li> <li>• L = 258 x B = 217 mm</li> <li>• auf Velo Eurolochkarte</li> </ul>	<b>SADDLE ›ELASTO GRIP‹</b> <ul style="list-style-type: none"> <li>• with <b>handle</b> at the back for <b>easy parking</b> of double leg stands, e. g. E-bikes, ...</li> <li>• with <b>Elastomer-Shock-Absorbing</b> and <b>child protection</b></li> <li>• "Arc-Tech" <b>suspension</b></li> <li>• side and rear <b>abrasion protection</b></li> <li>• only 725 g</li> <li>• L = 258 x W = 217 mm</li> <li>• on Velo eurohole card</li> </ul>	<div data-bbox="1182 1816 1246 1839" style="border: 1px solid black; padding: 2px; display: inline-block;">GRIP</div> 
		UVP 44,90 €	





ART.-NR.	BESCHREIBUNG	DESCRIPTION	
<b>250069</b> 10	<b>SATTEL ›ELASTO D2‹</b> <ul style="list-style-type: none"> <li>mit <b>Elastomer-Shock-Absorbing</b> und <b>Kinderschutz</b></li> <li>"Arc-Tech" <b>gedeierter</b> Stützpunkt</li> <li><b>sehr bequemer</b> Komfort-Sattel durch "D2"-Konstruktion</li> <li>nur 854 g</li> <li>vorderer, seitlicher und hinterer <b>Abriebschutz</b></li> <li>mit Sattelstützklemme</li> <li>schwarz</li> <li>L = 264 x B = 220 mm</li> <li>auf Velo Eurolochkarte</li> </ul>	<b>SADDLE ›ELASTO D2‹</b> <ul style="list-style-type: none"> <li>with <b>Elastomer-Shock-Absorbing</b> and <b>child protection</b></li> <li>"Arc-Tech" <b>suspension</b></li> <li><b>very comfortable</b> saddle because of "D2" construction</li> <li>only 854 g</li> <li>front, side and rear <b>abrasion protection</b></li> <li>with clamp for seat post</li> <li>black</li> <li>L = 264 x W = 220 mm</li> <li>on Velo eurohole card</li> </ul>	 <p>UVP 47,90 €</p>
<b>250130</b> 10	<b>SATTEL ›TOUR ELA GEN‹</b> <ul style="list-style-type: none"> <li>mit <b>Elastomer-Shock-Absorbing</b> und <b>Kinderschutz</b></li> <li>"Arc-Tech" <b>gedeierter</b> Stützpunkt</li> <li><b>Aluminium-Look</b>-Gestell mit Skala</li> <li>sehr bequemer Komfort-Sattel durch "D2"-Konstruktion</li> <li>vorderer, seitlicher und hinterer <b>Abriebschutz</b></li> <li>mit Sattelstützklemme</li> <li>mit braunem <b>Echtleiderüberzug</b></li> <li>nur 867 g</li> <li>L = 264 x B = 220 mm</li> <li>auf Velo Plush Eurolochkarte</li> </ul>	<b>SADDLE ›TOUR ELA GEN‹</b> <ul style="list-style-type: none"> <li>with <b>Elastomer-Shock-Absorbing</b> and <b>child protection</b></li> <li>"Arc-Tech" <b>suspension</b></li> <li><b>aluminium look</b> rails with scale</li> <li>very comfortable saddle because of "D2" construction</li> <li>front, side and rear <b>abrasion protection</b></li> <li>with clamp for seat post</li> <li>with brown <b>genuine leather cover</b></li> <li>only 867 g</li> <li>L = 264 x W = 220 mm</li> <li>on Velo Plush eurohole card</li> </ul>	 <p>UVP 85,90 €</p>
<b>250128</b> 10	<b>SATTEL ›TOUR ELA X‹</b> <ul style="list-style-type: none"> <li>wie Art. 250130, aber</li> <li>mit Kunstlederbezug in <b>Echtleideroptik</b></li> <li>nur 847 g</li> <li>L = 260 x B = 220 mm</li> <li>auf Velo Plush Eurolochkarte</li> </ul>	<b>SADDLE ›TOUR ELA X‹</b> <ul style="list-style-type: none"> <li>like art. 250130, but</li> <li>with leatherette cover in <b>genuine leather appearance</b></li> <li>only 847 g</li> <li>L = 260 x W = 220 mm</li> <li>on Velo Plush eurohole card</li> </ul>	 <p>UVP 55,90 €</p>
<b>250180</b> 10 	<b>SATTEL ›TOUR DS GEL‹</b> <ul style="list-style-type: none"> <li><b>Aluminium-Look</b>-Gestell</li> <li>sehr bequemer Komfort-Sattel</li> <li>mit <b>Zug- und Druckfeder</b></li> <li>mit <b>Gel</b>einlage</li> <li>mit Sattelstützklemme</li> <li>L = 265 x B = 255 mm</li> <li>auf Velo Plush Eurolochkarte</li> </ul>	<b>SADDLE ›TOUR DS GEL‹</b> <ul style="list-style-type: none"> <li><b>aluminium look</b> rails</li> <li>very comfortable saddle</li> <li>with <b>2-way double coil springs</b></li> <li>with <b>gel</b> inlay</li> <li>with clamp for seat post</li> <li>L = 265 x W = 255 mm</li> <li>on Velo Plush eurohole card</li> </ul>	<div style="display: flex; justify-content: space-between;"> <div data-bbox="965 1601 1045 1624">GEL</div> <div data-bbox="1236 1601 1340 1646">  <p>Plush A Philosophy of Comfort</p> </div> </div>  <p>UVP 63,90 €</p>

ART.-NR. 	BESCHREIBUNG	DESCRIPTION	
<b>BMX</b> <span style="float: right;"><b>BMX</b></span>			
<b>250290</b> 20	<b>SATTEL ›MELOW‹</b> <ul style="list-style-type: none"> <li>• <b>hochwertiger BMX-Sattel</b></li> <li>• seitlicher und hinterer <b>Abriebschutz</b></li> <li>• für <b>Freestyle</b> oder <b>Dirt</b></li> <li>• L = 247 x B = 137 mm</li> <li>• auf Velo Eurolochkarte</li> </ul> 	<b>SADDLE ›MELOW‹</b> <ul style="list-style-type: none"> <li>• <b>high grade BMX saddle</b></li> <li>• side and rear <b>abrasion protection</b></li> <li>• for <b>freestyle</b> or <b>dirt</b></li> <li>• L = 247 x W = 137 mm</li> <li>• on Velo eurohole card</li> </ul> <p style="text-align: right;">UVP 27,90 €</p>	 <p><b>PROTECTION</b></p>
<b>JUGEND / KINDER</b> <span style="float: right;"><b>YOUTH / CHILD</b></span>			
<b>250239</b> 20	<b>JUGENDSATTEL ›JUNIOR GEL‹</b> <ul style="list-style-type: none"> <li>• <b>hochwertiger Jugend-Gel-Sattel</b></li> <li>• seitlicher und hinterer <b>Abriebschutz</b></li> <li>• mit Sattelstützklemme</li> <li>• für 16" - 24"</li> <li>• L = 226 x B = 150 mm</li> <li>• auf Velo Plush Eurolochkarte</li> </ul>  	<b>YOUTH SADDLE ›JUNIOR GEL‹</b> <ul style="list-style-type: none"> <li>• <b>high grade junior gel saddle</b></li> <li>• side and rear <b>abrasion protection</b></li> <li>• with clamp for seat post</li> <li>• for 16" - 24"</li> <li>• L = 226 x W = 150 mm</li> <li>• on Velo Plush eurohole card</li> </ul> <p style="text-align: right;">UVP 32,90 €</p>	 <p><b>Plush</b> A Philosophy of Comfort</p>
<b>250207</b> 20	<b>JUGENDSATTEL ›JUNIOR‹</b> <ul style="list-style-type: none"> <li>• <b>hochwertiger Jugendsattel</b></li> <li>• "Arc-Tech" <b>gefederter</b> Stützpunkt</li> <li>• "O-Zone Base Cut"</li> <li>• mit Sattelstützklemme</li> <li>• für 16" - 24"</li> <li>• L = 227 x B = 145 mm</li> <li>• auf Velo Eurolochkarte</li> </ul>   	<b>YOUTH SADDLE ›JUNIOR‹</b> <ul style="list-style-type: none"> <li>• <b>high grade junior saddle</b></li> <li>• "Arc-Tech" <b>suspension</b></li> <li>• "O-Zone Base Cut"</li> <li>• with clamp for seat post</li> <li>• for 16" - 24"</li> <li>• L = 227 x W = 145 mm</li> <li>• on Velo eurohole card</li> </ul> <p style="text-align: right;">UVP 29,90 €</p>	
<b>250206</b> 20	<b>KINDERSATTEL ›CHILDREN‹</b> <ul style="list-style-type: none"> <li>• <b>hochwertiger Kindersattel</b></li> <li>• "Arc-Tech" <b>gefederter</b> Stützpunkt</li> <li>• seitlicher und hinterer <b>Abriebschutz</b></li> <li>• mit Sattelstützklemme</li> <li>• für 12" - 16"</li> <li>• L = 206 x B = 153 mm</li> <li>• auf Velo Eurolochkarte</li> </ul>  	<b>CHILD SADDLE ›CHILDREN‹</b> <ul style="list-style-type: none"> <li>• <b>high grade child saddle</b></li> <li>• "Arc-Tech" <b>suspension</b></li> <li>• side and rear <b>abrasion protection</b></li> <li>• with clamp for seat post</li> <li>• for 12" - 16"</li> <li>• L = 206 x W = 153 mm</li> <li>• on Velo eurohole card</li> </ul> <p style="text-align: right;">UVP 26,90 €</p>	





ART.-NR.	BESCHREIBUNG	DESCRIPTION	
	<p><b>SÄTTEL VON M-WAVE</b>  <b>Hervorragende Qualität zum kleinen Preis!</b></p> <p>Mit unserer Sattelkollektion von M-Wave ist es uns gelungen, Ihnen Sättel mit <b>technischen Finessen</b> und einer Ausstattung anzubieten, wie dies bisher nur in höheren Preislagen möglich war. Dies gilt sowohl für das <b>Design</b> als auch für <b>funktionelle Ausstattungsmerkmale</b>, wie verschiedene <b>Druckentlastungssysteme, Luftstromkühlung</b> und <b>Abriebschutz</b>. Eine <b>sehr gute Verarbeitung</b> ist selbstverständlich.</p>	<p><b>SADDLES MADE BY M-WAVE</b>  <b>Excellent quality for a small price!</b></p> <p>With our M-Wave saddle collection we managed to offer you saddles with <b>technical finesse</b> and specs that have only been possible in higher price levels so far. This applies for their <b>design</b> as well as <b>functional details</b> like several <b>pressure relief systems, air channel cooling</b> or <b>rub-off protection</b>. A <b>very good finish</b> is self-evident.</p>	 <p>M-WAVE</p>   

**COMPETITION** **COMPETITION**

<p><b>251010</b></p> <p>40</p>	<p><b>SATTEL ›SPIDER‹</b></p> <ul style="list-style-type: none"> <li>• <b>W-B-W</b>-Gestell mit <b>Skala</b></li> <li>• <b>V-Design</b></li> <li>• <b>"Full Cut"</b></li> <li>• mit <b>Abriebschutz rechts und links</b></li> <li>• nur <b>312 g</b></li> <li>• L = 280 x B = 144 mm</li> </ul>	<p><b>SADDLE ›SPIDER‹</b></p> <ul style="list-style-type: none"> <li>• <b>W-B-W rails with scale</b></li> <li>• <b>V-Design</b></li> <li>• <b>"Full Cut"</b></li> <li>• with <b>abrasion protection right and left</b></li> <li>• only <b>312 g</b></li> <li>• L = 280 x W = 144 mm</li> </ul> <p style="text-align: right;">UVP 23,90 €</p>	
--------------------------------	---	--	---



<p><b>251038</b></p> <p>40</p>	<p><b>SATTEL ›COMP XI‹</b></p> <ul style="list-style-type: none"> <li>• <b>stabile Nylon-Schale</b></li> <li>• <b>CrMo</b>-Gestell mit <b>Skala</b></li> <li>• <b>"Full Cut"</b></li> <li>• <b>wasserdicht durch Vakuum-Technologie</b> (verschweißte, wasserdichte und nahtlose Oberfläche)</li> <li>• nur <b>282 g</b></li> <li>• L = 255 x B = 145 mm</li> </ul>	<p><b>SADDLE ›COMP XI‹</b></p> <ul style="list-style-type: none"> <li>• <b>stable nylon base</b></li> <li>• <b>CrMo rails with scale</b></li> <li>• <b>"Full Cut"</b></li> <li>• <b>waterproof because of vacuum technology</b> (welded, waterproof and seamless surface)</li> <li>• only <b>282 g</b></li> <li>• L = 255 x W = 145 mm</li> </ul> <p style="text-align: right;">UVP 18,80 €</p>	<p><b>NYLON</b></p> 
--------------------------------	---	---	--

<p><b>251030</b></p> <p>40</p>	<p><b>SATTEL ›FRITZ‹</b></p> <ul style="list-style-type: none"> <li>• <b>Aluminium-Look</b>-Gestell mit <b>Skala</b></li> <li>• nur <b>282 g</b></li> <li>• L = 298 x B = 130 mm</li> </ul>	<p><b>SADDLE ›FRITZ‹</b></p> <ul style="list-style-type: none"> <li>• <b>aluminium look rails with scale</b></li> <li>• only <b>282 g</b></li> <li>• L = 298 x W = 130 mm</li> </ul> <p style="text-align: right;">UVP 17,90 €</p>	
--------------------------------	---	--	--

ART.-NR. 	BESCHREIBUNG	DESCRIPTION	
<p>• <b>251011</b></p> <p>40</p>	<p><b>SATTEL ›COMP II‹</b></p> <ul style="list-style-type: none"> <li>• Aluminium-Look-Gestell mit Skala</li> <li>• V-Design</li> <li>• "Base Cut"</li> <li>• nur 265 g</li> <li>• L = 268 x B = 134 mm</li> </ul>	<p><b>SADDLE ›COMP II‹</b></p> <ul style="list-style-type: none"> <li>• aluminium look rails with scale</li> <li>• V-Design</li> <li>• "Base Cut"</li> <li>• only 265 g</li> <li>• L = 268 x W = 134 mm</li> </ul> <p>UVP 12,90 €</p>	
<p>• <b>251055</b></p> <p>48</p>	<p><b>SATTEL ›COMP V‹</b></p> <ul style="list-style-type: none"> <li>• Gestell mit Skala</li> <li>• „Full-Cut“</li> <li>• nur 297 g</li> <li>• L = 270 x B = 140 mm</li> </ul>	<p><b>SADDLE ›COMP V‹</b></p> <ul style="list-style-type: none"> <li>• rails with scale</li> <li>• „Full-Cut“</li> <li>• only 297 g</li> <li>• L = 270 x W = 140 mm</li> </ul> <p>UVP 12,90 €</p>	
<p><b>251015</b></p> <p>35</p>	<p><b>SATTEL ›COMP IV‹</b></p> <ul style="list-style-type: none"> <li>• Aluminium-Look-Gestell mit Skala</li> <li>• V-Design</li> <li>• hinterer und seitlicher Abriebschutz</li> <li>• nur 336 g</li> <li>• L = 270 x B = 155 mm</li> </ul>	<p><b>SADDLE ›COMP IV‹</b></p> <ul style="list-style-type: none"> <li>• aluminium look rails with scale</li> <li>• V-Design</li> <li>• rear and side abrasion protection</li> <li>• only 336 g</li> <li>• L = 270 x W = 155 mm</li> </ul> <p>UVP 13,90 €</p>	
<p><b>251013</b></p> <p>35</p>	<p><b>SATTEL ›COMP VI‹</b></p> <ul style="list-style-type: none"> <li>• Aluminium-Look-Gestell mit Skala</li> <li>• V-Design</li> <li>• "Full-Cut"</li> <li>• besonders hochwertige und stabile Sattelschale</li> <li>• nur 347 g</li> <li>• L = 270 x B = 152 mm</li> </ul>	<p><b>SADDLE ›COMP VI‹</b></p> <ul style="list-style-type: none"> <li>• aluminium look rails with scale</li> <li>• V-Design</li> <li>• "Full-Cut"</li> <li>• stable base of high quality</li> <li>• only 347 g</li> <li>• L = 270 x W = 152 mm</li> </ul> <p>UVP 13,90 €</p>	



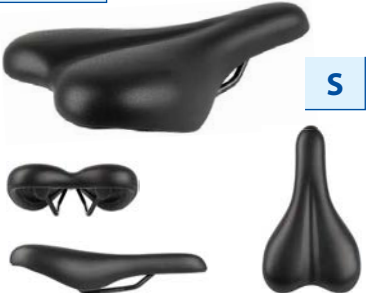

ART.-NR. 	BESCHREIBUNG	DESCRIPTION	
• 251012 40	<b>SATTEL ›COMP X‹</b> <ul style="list-style-type: none"> <li>• Aluminium-Look-Gestell mit <b>Skala</b></li> <li>• <b>V-Design</b></li> <li>• <b>"Full-Cut"</b></li> <li>• nur 286 g</li> <li>• L = 270 x B = 139 mm</li> </ul>	<b>SADDLE ›COMP X‹</b> <ul style="list-style-type: none"> <li>• aluminium look rails with <b>scale</b></li> <li>• <b>V-Design</b></li> <li>• <b>"Full-Cut"</b></li> <li>• only 286 g</li> <li>• L = 270 x W = 139 mm</li> </ul>	 <p style="text-align: right;">UVP 11,90 €</p>
<b>TOUR</b>		<b>TOUR</b>	
251016 30	<b>SATTEL ›TOUR II‹</b> <ul style="list-style-type: none"> <li>• Gestell mit <b>Skala</b></li> <li>• <b>"Full-Cut"</b></li> <li>• mit <b>"Deep Channel"</b> Luftkühlung</li> <li>• hinterer und seitlicher <b>Abriebschutz</b></li> <li>• nur 391 g</li> <li>• L = 262 x B = 156 mm</li> </ul>	<b>SADDLE ›TOUR II‹</b> <ul style="list-style-type: none"> <li>• rails with <b>scale</b></li> <li>• <b>"Full-Cut"</b></li> <li>• with <b>"Deep Channel"</b> air cooling</li> <li>• rear and side <b>abrasion protection</b></li> <li>• only 391 g</li> <li>• L = 262 x W = 156 mm</li> </ul>	 <p style="text-align: right;">UVP 14,90 €</p>
• 251019 25	<b>SATTEL ›VACU TOUR IV‹</b> <ul style="list-style-type: none"> <li>• Gestell mit <b>Skala</b></li> <li>• <b>"Full-Cut"</b></li> <li>• <b>gefederter Stützpunkt</b></li> <li>• mit <b>Luftkanal</b> hinten</li> <li>• L = 260 x B = 186 mm</li> </ul> <p>• schwarz</p> <p>• besonders <b>weicher Vakuum-Sattel</b> mit nahtloser Oberfläche</p> <p>• nur 451 g</p>	<b>SADDLE ›VACU TOUR IV‹</b> <ul style="list-style-type: none"> <li>• rails with <b>scale</b></li> <li>• <b>"Full-Cut"</b></li> <li>• <b>rail suspension</b></li> <li>• with rear <b>air channel</b></li> <li>• L = 260 x W = 186 mm</li> </ul> <p>• black</p> <p>• extra <b>soft vacuum saddle</b> with seamless cover</p> <p>• only 451 g</p>	<p><b>VACUUM</b></p>  <p style="text-align: right;">UVP 18,90 €</p>
• 251020 35	<ul style="list-style-type: none"> <li>• braun</li> <li>• mit hinterem Abriebschutz</li> <li>• nur 440 g</li> </ul>	<ul style="list-style-type: none"> <li>• brown</li> <li>• rear abrasion protection</li> <li>• only 440 g</li> </ul>	 <p style="text-align: right;">UVP 18,90 €</p>

ART.-NR.	BESCHREIBUNG	DESCRIPTION	
<b>CITY</b>			
<b>CITY</b>			<b>CITY</b>
<p>• <b>251037</b></p> <p>20</p> <p><b>TIP</b></p>	<p><b>SATTEL ›VACU CITY II‹</b></p> <ul style="list-style-type: none"> <li>• schwarzes Gestell mit <b>Skala</b></li> <li>• <b>wasserdicht durch Vakuum-Technologie</b> (verschweißte, wasserdichte und nahtlose Oberfläche)</li> <li>• nur 464 g</li> <li>• L = 260 x B = 210 mm</li> </ul>	<p><b>SADDLE ›VACU CITY II‹</b></p> <ul style="list-style-type: none"> <li>• black rails with <b>scale</b></li> <li>• <b>waterproof</b> because of <b>vacuum technology</b> (welded, waterproof and seamless surface)</li> <li>• only 464 g</li> <li>• L = 260 x W = 210 mm</li> </ul> <p style="text-align: right;">UVP 16,90 €</p>	<p><b>VACUUM</b></p> 
<p>• <b>251029</b></p> <p>36</p>	<p><b>SATTEL ›VACU CITY‹</b></p> <ul style="list-style-type: none"> <li>• schwarzes Gestell mit <b>Skala</b></li> <li>• <b>wasserdicht durch Vakuum-Technologie</b> (verschweißte, wasserdichte und nahtlose Oberfläche)</li> </ul> <p><b>Größe S</b></p> <ul style="list-style-type: none"> <li>• nur 329 g</li> <li>• L = 275 x B = <b>156 mm</b></li> </ul>	<p><b>SADDLE ›VACU CITY‹</b></p> <ul style="list-style-type: none"> <li>• black rails with <b>scale</b></li> <li>• <b>waterproof</b> because of <b>vacuum technology</b> (welded, waterproof and seamless surface)</li> </ul> <p><b>size S</b></p> <ul style="list-style-type: none"> <li>• only 329 g</li> <li>• L = 275 x W = <b>156 mm</b></li> </ul> <p style="text-align: right;">UVP 11,90 €</p>	<p><b>VACUUM</b></p> 
<p><b>251071</b></p> <p><b>NEW</b></p> <p>30</p>	<p><b>Größe M</b></p> <ul style="list-style-type: none"> <li>• nur 389 g</li> <li>• L = 265 x B = 165 mm</li> </ul>	<p><b>size M</b></p> <ul style="list-style-type: none"> <li>• only 389 g</li> <li>• L = 265 x W = 165 mm</li> </ul> <p style="text-align: right;">UVP 13,90 €</p>	
<p>• <b>251039</b></p>	<p><b>Größe L</b></p> <ul style="list-style-type: none"> <li>• nur 415 g</li> <li>• L = 268 x B = <b>190 mm</b></li> </ul>	<p><b>size L</b></p> <ul style="list-style-type: none"> <li>• only 415 g</li> <li>• L = 268 x W = <b>190 mm</b></li> </ul> <p style="text-align: right;">UVP 14,90 €</p>	
<p>• <b>251028</b></p> <p>20</p>	<p><b>Größe XL</b></p> <ul style="list-style-type: none"> <li>• nur 459 g</li> <li>• L = 257 x B = <b>211 mm</b></li> </ul>	<p><b>size XL</b></p> <ul style="list-style-type: none"> <li>• only 459 g</li> <li>• L = 257 x W = <b>211 mm</b></li> </ul> <p style="text-align: right;">UVP 15,90 €</p>	

ART.-NR. 	BESCHREIBUNG	DESCRIPTION	
<b>251072</b>  16	<b>Größe XL</b> <ul style="list-style-type: none"> <li>• mit <b>Griff</b></li> <li>• nur 509 g</li> <li>• L = 254 x B = 209 mm</li> </ul>	<b>size XL</b> <ul style="list-style-type: none"> <li>• with <b>handle</b></li> <li>• only 509 g</li> <li>• L = 254 x W = 209 mm</li> </ul> UVP 19,90 €	    <div style="text-align: right;"><b>XL</b></div>
<b>251051</b> 12	<b>Größe XL</b> <ul style="list-style-type: none"> <li>• mit <b>Elastomer-Federung</b></li> <li>• nur 698 g</li> <li>• L = 261 x B = <b>223 mm</b></li> </ul>	<b>size XL</b> <ul style="list-style-type: none"> <li>• with <b>elastomer suspension</b></li> <li>• only 698 g</li> <li>• L = 261 x W = <b>223 mm</b></li> </ul> UVP 19,90 €	    <div style="text-align: right;"><b>XL</b></div>
<b>251073</b>  16	<b>Größe XL</b> <ul style="list-style-type: none"> <li>• mit <b>Elastomer-Federung</b></li> <li>• nur 709 g</li> <li>• L = 253 x B = 221 mm</li> </ul>	<b>size XL</b> <ul style="list-style-type: none"> <li>• with <b>elastomer suspension</b></li> <li>• only 709 g</li> <li>• L = 253 x W = 221 mm</li> </ul> UVP 23,90 €	    <div style="text-align: right;"><b>XL</b></div>
<b>251023</b> 12	<b>SATTEL ›ELAST XXL CITY‹</b> <ul style="list-style-type: none"> <li>• schwarzes Gestell mit <b>Skala</b></li> <li>• mit <b>Elastomer-Federung</b></li> <li>• hinterer und seitlicher <b>Abriebschutz</b></li> <li>• mit <b>Sattelstützklemme</b></li> <li>• nur 986 g</li> <li>• L = 291 x B = 276 mm</li> </ul>	<b>SADDLE ›ELAST XXL CITY‹</b> <ul style="list-style-type: none"> <li>• black rails with <b>scale</b></li> <li>• with <b>elastomer</b> suspension</li> <li>• rear and side <b>abrasion protection</b></li> <li>• with <b>clamp</b> for seat post</li> <li>• only 986 g</li> <li>• L = 291 x W = 276 mm</li> </ul> UVP 28,90 €	<div style="text-align: right;"><b>120 KG ✓</b></div> <div style="text-align: right;"><b>XXL</b></div>      <div style="text-align: center;"><b>X-TRA WIDE</b></div>

ART.-NR. 	BESCHREIBUNG	DESCRIPTION	
<p><b>251034</b> 18</p> <p><b>251027</b> 16</p>	<p><b>SATTEL ›ELAST CITY‹</b></p> <ul style="list-style-type: none"> <li>• <b>Elastomer-Federung</b></li> <li>• vorderer und hinterer Abriebschutz</li> <li>• schwarzes Gestell mit Skala</li> </ul> <p><b>Größe M</b> L = 260 mm x B = 185 mm</p> <p><b>Größe L</b> L = 265 mm x B = 200 mm</p>	<p><b>SADDLE ›ELAST CITY‹</b></p> <ul style="list-style-type: none"> <li>• <b>elastomer suspension</b></li> <li>• front and rear abrasion protection</li> <li>• black rails with scale</li> </ul> <p><b>size M</b> L = 260 mm x W = 185 mm</p> <p><b>size L</b> L = 265 mm x W = 200 mm</p> <p>UVP 22,90 €</p>	
<p><b>251022</b> 16</p>	<p>braune <b>Echtlederoptik</b></p> <p><b>Größe L</b> L = 265 mm x B = 200 mm</p>	<p>brown <b>genuine leather appearance</b></p> <p><b>size L</b> L = 265 mm x W = 200 mm</p> <p>UVP 22,90 €</p>	
<p><b>251060</b> 16</p>	<p><b>SATTEL ›EVA CITY‹</b></p> <ul style="list-style-type: none"> <li>• sehr weicher <b>EVA</b>-Sattel</li> <li>• sehr <b>umweltfreundliches</b> Obermaterial</li> <li>• robuste Oberfläche</li> <li>• nur 448 g</li> <li>• L = 262 x B = 216 mm</li> </ul>	<p><b>SADDLE ›EVA CITY‹</b></p> <ul style="list-style-type: none"> <li>• very soft <b>EVA</b>-saddle</li> <li>• very <b>environmentally friendly</b> upper material</li> <li>• robust surface</li> <li>• only 448 g</li> <li>• L = 262 x W = 216 mm</li> </ul> <p>UVP 17,90 €</p>	
<p><b>251021</b> 20</p>	<p><b>SATTEL ›CITY SPRING‹</b></p> <ul style="list-style-type: none"> <li>• schwarzes Gestell</li> <li>• mit <b>Federn</b></li> <li>• mit <b>Sattelstützklemme</b></li> <li>• nur 625 g</li> <li>• L = 235 x B = 205 mm</li> </ul>	<p><b>SADDLE ›CITY SPRING‹</b></p> <ul style="list-style-type: none"> <li>• black rails</li> <li>• with <b>springs</b></li> <li>• with <b>clamp for seat post</b></li> <li>• only 625 g</li> <li>• L = 235 x W = 205 mm</li> </ul> <p>UVP 13,90 €</p>	



ART.-NR.	BESCHREIBUNG	DESCRIPTION	
<b>JUGEND / KINDER</b>		<b>YOUTH / CHILD</b>	
<b>251049</b> 30	<b>SATTEL ›TEEN TWO‹</b> <ul style="list-style-type: none"> <li>• für 24" (20" - 26")</li> <li>• "Base Cut"</li> <li>• vorderer und hinterer Abriebschutz</li> <li>• mit <b>Sattelstützklemme</b></li> <li>• nur <b>493 g</b></li> <li>• L = 242 x B = 143 mm</li> </ul>	<b>SADDLE ›TEEN TWO‹</b> <ul style="list-style-type: none"> <li>• for 24" (20" - 26")</li> <li>• "Base Cut"</li> <li>• front and rear abrasion protection</li> <li>• with <b>clamp for seat post</b></li> <li>• only <b>493 g</b></li> <li>• L = 242 x W = 143 mm</li> </ul>	 UVP 11,90 €
<b>251025</b> 24	<b>SATTEL ›TEEN‹</b> <ul style="list-style-type: none"> <li>• für 20" (16" - 24")</li> <li>• mit <b>Sattelstützklemme</b></li> <li>• nur 433 g</li> <li>• L = 216 x B = 168 mm</li> </ul>	<b>SADDLE ›TEEN‹</b> <ul style="list-style-type: none"> <li>• for 20" (16" - 24")</li> <li>• with <b>clamp for seat post</b></li> <li>• only 433 g</li> <li>• L = 216 x W = 168 mm</li> </ul>	 UVP 10,90 €
<b>251032</b> 30	<b>SATTEL ›KID GRIP‹</b> <ul style="list-style-type: none"> <li>• für 12" - 16"</li> <li>• <b>integrierter</b> Trage- und Haltegriff</li> <li>• mit <b>Sattelstützklemme</b></li> <li>• <b>360° Abriebschutz</b></li> <li>• nur 398 g</li> <li>• L = 207 x B = 135 mm</li> </ul>	<b>SADDLE ›KID GRIP‹</b> <ul style="list-style-type: none"> <li>• for 12" - 16"</li> <li>• <b>integrated handle</b> for carrying</li> <li>• with <b>clamp for seat post</b></li> <li>• <b>360° abrasion protection</b></li> <li>• only 398 g</li> <li>• L = 207 x W = 135 mm</li> </ul>	 Tested by the manufacturer according to ISO 4210 UVP 8,90 €

### INFO

Für den Verkauf am POS können Sie alle M-Wave Sättel auch mit unserer speziell entworfenen **M-Wave Euroloch-Sattelkarte** (Art. 083173) bekommen. Die Sättel können zur Vorführung beim Kunden **leicht abgenommen** und **wieder aufgesteckt** werden.



For presentation at the POS you can also get all M-Wave saddles with our specially designed **M-Wave eurohole saddle card** (art. 083173). The saddles can **easily be taken off** and **put back on** again for showing the customers.



ART.-NR.	BESCHREIBUNG	DESCRIPTION	
<b>SPORT</b>			
<p>• <b>250075</b></p> <p>30</p>	<p><b>SATTEL ›ASA R1‹</b></p> <ul style="list-style-type: none"> <li>• <b>V-Design</b></li> <li>• mit <b>Air-Shock-Absorbing</b></li> <li>• Gestell mit Skala</li> <li>• nur <b>274 g</b></li> <li>• L = 280 x B = 142 mm</li> </ul>	<p><b>SADDLE ›ASA R1‹</b></p> <ul style="list-style-type: none"> <li>• <b>V-Design</b></li> <li>• with <b>Air-Shock-Absorbing</b></li> <li>• rails with scale</li> <li>• only <b>274 g</b></li> <li>• L = 280 x W = 142 mm</li> </ul>	  <p>UVP 8,90 €</p>
<p><b>250152</b></p> <p>30</p>	<p><b>SATTEL ›ASA ECO C &amp; T‹</b></p> <ul style="list-style-type: none"> <li>• <b>universeller</b> MTB und Trekking-Sattel</li> <li>• mit <b>Air-Shock-Absorbing</b></li> <li>• mit vorderem und hinterem <b>Abriebschutz</b></li> <li>• nur 315 g</li> <li>• L = 262 x B = 150 mm</li> </ul>	<p><b>SADDLE ›ASA ECO C &amp; T‹</b></p> <ul style="list-style-type: none"> <li>• <b>universal</b> MTB and trekking saddle</li> <li>• with <b>Air-Shock-Absorbing</b></li> <li>• with front and rear <b>abrasion protection</b></li> <li>• only 315 g</li> <li>• L = 262 x W = 150 mm</li> </ul>	 <p>UVP 9,90 €</p>
<p>• <b>250166</b></p> <p>30</p>	<p><b>SATTEL ›ASA R3‹</b></p> <ul style="list-style-type: none"> <li>• <b>MTB/Rennrad-Sattel</b></li> <li>• mit <b>Air-Shock-Absorbing</b></li> <li>• <b>universell</b> einsetzbar</li> <li>• <b>sehr gutes Preis-/Leistungsverhältnis</b></li> <li>• L = 262 x B = 142 mm</li> </ul>	<p><b>SADDLE ›ASA R3‹</b></p> <ul style="list-style-type: none"> <li>• <b>MTB/racing</b> saddle</li> <li>• with <b>Air-Shock-Absorbing</b></li> <li>• for <b>universal</b> purposes</li> <li>• <b>great value for money</b></li> <li>• L = 262 x W = 142 mm</li> </ul>	 <p>UVP 6,90 €</p>
<p><b>251040</b></p> <p><b>251042</b></p> <p><b>251050</b></p> <p>30</p>	<p><b>SATTEL ›RIVET‹</b></p> <ul style="list-style-type: none"> <li>• Kunstlederbezug mit sechs <b>Edelstahlnieten</b></li> <li>• nur 297 g</li> <li>• L = 276 x B = 152 mm</li> </ul> <p>schwarz</p> <p>weiß</p> <p>braun</p>	<p><b>SADDLE ›RIVET‹</b></p> <ul style="list-style-type: none"> <li>• imitation leather cover with six <b>stainless steel rivets</b></li> <li>• only 297 g</li> <li>• L = 276 x W = 152 mm</li> </ul> <p>black</p> <p>white</p> <p>brown</p>	  <p>UVP 11,90 €</p>

ART.-NR.	BESCHREIBUNG	DESCRIPTION	
<b>TOUR</b>		<b>TOUR</b>	
<p><b>250120</b></p> <p>20</p>	<p><b>SATTEL ›ASA TOUR‹</b></p> <ul style="list-style-type: none"> <li>• <b>bequemer Komfort-Sattel</b></li> <li>• <b>"Full-Cut"</b></li> <li>• mit <b>Luftstromkühlung</b></li> <li>• L = 255 x B = 209 mm</li> </ul>	<p><b>SADDLE ›ASA TOUR‹</b></p> <ul style="list-style-type: none"> <li>• <b>comfortable saddle</b></li> <li>• <b>"Full-Cut"</b></li> <li>• with <b>air cooling</b></li> <li>• L = 255 x W = 209 mm</li> </ul>	 <p><b>AIR-COOL</b></p> <p>UVP 12,90 €</p>
<p>• <b>250077</b></p> <p>20</p>	<p><b>SATTEL ›E-GRIP‹</b></p> <ul style="list-style-type: none"> <li>• mit <b>Griff</b> hinten zum <b>einfachen Abstellen</b> auf Doppelbeinständer, z. B. E-Bikes, ...</li> <li>• mit Sattelstützklemme</li> <li>• L = 260 x B = 200 mm</li> </ul>	<p><b>SADDLE ›E-GRIP‹</b></p> <ul style="list-style-type: none"> <li>• with <b>handle</b> at the back for <b>easy parking</b> of double leg stands, e. g. e-bikes, ...</li> <li>• with clamp for seat post</li> <li>• L = 260 x W = 200 mm</li> </ul>	 <p><b>E</b></p> <p>UVP 11,90 €</p>
<p>• <b>250141</b></p> <p>25</p>	<p><b>SATTEL ›ASA ECO T &amp; M‹</b></p> <ul style="list-style-type: none"> <li>• <b>universeller MTB und Trekking-Sattel</b></li> <li>• mit <b>Air-Shock-Absorbing</b></li> <li>• mit <b>Reflektor</b></li> <li>• L = 260 x B = 180 mm</li> </ul>	<p><b>SADDLE ›ASA ECO T &amp; M‹</b></p> <ul style="list-style-type: none"> <li>• <b>universal MTB and trekking saddle</b></li> <li>• with <b>Air-Shock-Absorbing</b></li> <li>• with <b>reflector</b></li> <li>• L = 260 x W = 180 mm</li> </ul>	 <p>UVP 8,90 €</p>
<b>ELASTOMER</b>		<b>ELASTOMER</b>	
<p><b>250082</b></p> <p>20</p>	<p><b>SATTEL ›ELASTOMER GEL C‹</b></p> <ul style="list-style-type: none"> <li>• <b>City-Edition</b></li> <li>• sehr <b>bequemer Komfort-Gel-Sattel</b></li> <li>• mit <b>Elastomer-Shock-Absorbing</b>, dient gleichzeitig als <b>Schutz für Kinderfinger</b></li> <li>• mit vorderem, seitlichem und hinterem <b>Abriebschutz</b></li> <li>• mit Sattelstützklemme</li> <li>• L = 254 x B = 208 mm</li> </ul>	<p><b>SADDLE ›ELASTOMER GEL C‹</b></p> <ul style="list-style-type: none"> <li>• <b>City edition</b></li> <li>• very <b>comfortable Gel saddle</b></li> <li>• with <b>Elastomer-Shock-Absorbing</b>, which is also a <b>protection for children's fingers</b></li> <li>• with front, side and rear <b>abrasion protection</b></li> <li>• with clamp for seat post</li> <li>• L = 254 x W = 208 mm</li> </ul>	<p><b>GEL</b></p>  <p>UVP 16,90 €</p>

Reflektor ohne deutsches Prüfzeichen - Verkauf und Nutzung im Geltungsbereich der StVZO (Deutschland) unzulässig (Abgabe nur an außerdeutsche Kunden).

ART.-NR. 	BESCHREIBUNG	DESCRIPTION	
<p><b>250025</b></p> <p>20</p>	<p><b>SATTEL</b></p> <ul style="list-style-type: none"> <li>• sehr bequemer Komfort-Sattel</li> <li>• mit <b>Elastomer-Shock-Absorbing</b>, dient gleichzeitig als <b>Schutz für Kinderfinger</b></li> <li>• mit vorderem, seitlichem und hinterem <b>Abriebschutz</b></li> <li>• mit Sattelstützklemme</li> </ul> <p>›ELASTOMER‹</p> <p><b>Trekking-Edition</b> L = 275 x B = 195 mm</p>	<p><b>SADDLE</b></p> <ul style="list-style-type: none"> <li>• very comfortable saddle</li> <li>• with <b>Elastomer-Shock-Absorbing</b>, which is also a <b>protection for children's fingers</b></li> <li>• with front, side and rear <b>abrasion protection</b></li> <li>• with clamp for seat post</li> </ul> <p>›ELASTOMER‹</p> <p><b>Trekking edition</b> L = 275 x W = 195 mm</p>	 <p>UVP 14,90 €</p>
<p>• <b>250060</b></p> <p>20</p>	<p>›ELASTOMER C‹</p> <p><b>City-Edition</b> L = 254 x B = 210 mm</p>	<p>›ELASTOMER C‹</p> <p><b>City edition</b> L = 254 x W = 210 mm</p>	 <p>UVP 14,90 €</p>

## FEDER

## SPRING

<p><b>250086</b></p> <p>20</p>	<p><b>SATTEL ›COIL SPRING‹</b></p> <ul style="list-style-type: none"> <li>• verchromtes Gestell</li> <li>• verchromte <b>Zug- und Druckfedern</b></li> <li>• mit <b>Reflektor</b></li> <li>• mit Sattelstützklemme</li> <li>• L = 262 x B = 240 mm</li> </ul>	<p><b>SADDLE ›COIL SPRING‹</b></p> <ul style="list-style-type: none"> <li>• c.p. rail</li> <li>• c.p. <b>2-way double coil springs</b></li> <li>• with <b>reflector</b></li> <li>• with clamp for seat post</li> <li>• L = 262 x W = 240 mm</li> </ul>	 <p>UVP 19,90 €</p>
--------------------------------	---	--	--

Reflektor ohne deutsches Prüfzeichen - Verkauf und Nutzung im Geltungsbereich der StVZO (Deutschland) unzulässig (Abgabe nur an außerdeutsche Kunden).



ART.-NR. 	BESCHREIBUNG	DESCRIPTION	
<p>• <b>250083</b></p> <p>20</p>	<p><b>SATTEL ›FC GEL AIR‹</b></p> <ul style="list-style-type: none"> <li>• mit <b>stoßabsorbierender Federung</b></li> <li>• mit <b>Luftstromkühlung</b></li> <li>• mit bequemer <b>Gel-Einlage</b></li> <li>• mit Sattelstützklemme</li> <li>• L = 255 x B = 205 mm</li> </ul>	<p><b>SADDLE ›FC GEL AIR‹</b></p> <ul style="list-style-type: none"> <li>• <b>shock absorption suspension</b></li> <li>• with <b>air cooling</b></li> <li>• with comfortable <b>gel inlay</b></li> <li>• with clamp for seat post</li> <li>• L = 255 x W = 205 mm</li> </ul>	<p><b>GEL</b></p>  <p><b>AIR-COOL</b></p>  <p><b>AIR-COOL</b></p> <p>UVP 14,90 €</p>

<p>• <b>250161</b></p> <p>30</p>	<p><b>SATTEL ›ECO C‹</b></p> <ul style="list-style-type: none"> <li>• mit <b>Federn</b></li> <li>• inkl. Klemme für Sattelstütze</li> <li>• L = 245 x B = 210 mm</li> </ul>	<p><b>SADDLE ›ECO C‹</b></p> <ul style="list-style-type: none"> <li>• with <b>springs</b></li> <li>• incl. clamp for seat post</li> <li>• L = 245 x W = 210 mm</li> </ul>	 <p>UVP 10,90 €</p>
----------------------------------	---	---	--

**JUGEND / KINDER**

**YOUTH/CHILD**

<p><b>250154</b></p> <p>30</p>	<p><b>SATTEL ›ECO MTB‹</b></p> <ul style="list-style-type: none"> <li>• für <b>24" (20" - 28")</b></li> <li>• mit Sattelstützklemme</li> <li>• L = 257 x B = 147 mm</li> </ul>	<p><b>SADDLE ›ECO MTB‹</b></p> <ul style="list-style-type: none"> <li>• for <b>24" (20" - 28")</b></li> <li>• with clamp for seat post</li> <li>• L = 257 x W = 147 mm</li> </ul>	 <p>UVP 7,90 €</p>
--------------------------------	--	---	--

ART.-NR. 	BESCHREIBUNG	DESCRIPTION	
<b>250203</b> 50	<b>JUGEND-/ KINDERSATTEL</b> <b>›ASA JUNIOR‹</b> <ul style="list-style-type: none"> <li>• für 12"-20"</li> <li>• mit Sattelstützklemme</li> <li>• L = 228 x B = 150 mm</li> </ul>	<b>JUNIOR/ CHILD SADDLE</b> <b>›ASA JUNIOR‹</b> <ul style="list-style-type: none"> <li>• for 12"-20"</li> <li>• with clamp for seat post</li> <li>• L = 228 x W = 150 mm</li> </ul>	 <p style="text-align: right;">UVP 9,90 €</p>
<ul style="list-style-type: none"> <li>• <b>250208</b> Design: schwarz</li> <li><b>251291</b> Design: smile</li> <li><b>251293</b> Design: Fußball blau 25</li> </ul>	<b>KINDERSATTEL</b> <b>›ASA KIDS‹</b> <ul style="list-style-type: none"> <li>• für 12" - 16"</li> <li>• mit Sattelstützklemme</li> <li>• L = 210 x B = 138 mm</li> </ul>	<b>CHILD SADDLE</b> <b>›ASA KIDS‹</b> <ul style="list-style-type: none"> <li>• for 12" - 16"</li> <li>• with clamp for seat post</li> <li>• L = 210 x W = 138 mm</li> </ul> <p>Design: black</p> <p>Design: smile</p> <p>Design: football blue</p>	   <p style="text-align: right;">UVP 8,90 €</p>
<ul style="list-style-type: none"> <li>• <b>250790</b> 200/10</li> </ul>	<b>SATTELKLOBEN</b> Sattelklemme für Kerzensattelstützen	<b>SADDLE CLAMP</b> for plain seat posts	 <p style="text-align: right;">UVP 1,90 €</p>
<b>INFO</b>	Auf Wunsch verpacken wir jeden Sattel auf eine <b>Ventura Eurolochkarte</b> (Art. 083127)	On request we'll attach any saddle to a <b>Ventura eurohole card</b> (art. 083127)	

ART.-NR.	BESCHREIBUNG	DESCRIPTION	
<b>130097</b> 100	<b>SATTEL-REGENÜBERZUG</b> <ul style="list-style-type: none"> <li>• <b>klein und leicht</b></li> <li>• aus Polyester</li> <li>• mit Kordelzug</li> <li>• große <b>Universalgröße</b></li> <li>• integrierte <b>Aufbewahrungstasche</b>, die leicht mit Klettbandern am Rahmen, Sattel, ... zu befestigen ist</li> <li>• auch mit Ihrem <b>individuellen Logo</b> erhältlich (Preis auf Anfrage)</li> <li>• auf Eurolochkarte</li> </ul>	<b>SADDLE RAIN COVER</b> <ul style="list-style-type: none"> <li>• <b>small and light</b></li> <li>• made of polyester</li> <li>• with cord for size adjustment</li> <li>• large <b>universal size</b></li> <li>• integrated <b>storage pocket</b> with hook and loop fasteners for easy attachment to the frame, saddle, ...</li> <li>• also available with your <b>individual logo</b> (price on application)</li> <li>• on eurohole card</li> </ul>	
<b>137651</b> <b>137657</b> 20	<b>GEL-SATTELDECKEN</b> <ul style="list-style-type: none"> <li>• sehr bequeme Satteldecken</li> <li>• <b>anatomisch</b> geformte Geleinlage</li> <li>• mit Spannschnur</li> <li>• auf Eurolochkarte</li> </ul> <p>›VELO ANATOMIC‹</p>	<b>GEL SADDLE COVERS</b> <ul style="list-style-type: none"> <li>• very comfortable saddle covers</li> <li>• <b>anatomic</b> formed GEL-inlay</li> <li>• with tensioning cord</li> <li>• on eurohole card</li> </ul> <p>›VELO ANATOMIC‹</p>	
<b>137600</b> <b>137601</b> 50	<p>›M-WAVE ›ANATOMIC‹</p>	<p>›M-WAVE ›ANATOMIC‹</p>	
<b>137621</b> <b>137641</b> 20	<p>›VELO STANDARD‹</p>	<p>›VELO STANDARD‹</p>	
<b>137624</b> <b>137642</b> <b>137680</b> 20	<p>›STANDARD‹, im Polybeutel</p> <p>schmal, ca. 275 x 170 mm (L x B)</p> <p>breit, ca. 260 x 235 mm (L x B)</p> <p><b>X-tra breit</b>, ca. 290 x 260 mm (L x B)</p>	<p>›STANDARD‹, in PE bag</p> <p>slim, approx. 275 x 170 mm (L x W)</p> <p>big, approx. 260 x 235 mm (L x W)</p> <p><b>X-tra wide</b>, approx. 290 x 260 mm (L x W)</p>	
<b>137660</b> <b>137661</b> 20	<p>VELO ›LITE TECH‹</p> <ul style="list-style-type: none"> <li>• sehr bequeme Satteldecke in modernem, <b>ergonomischem Design zur Druckentlastung</b></li> <li>• mit Spannschnur</li> <li>• mit <b>Luftstromkühlung</b></li> <li>• auf Velo Eurolochkarte</li> </ul>	<p>VELO ›LITE TECH‹</p> <ul style="list-style-type: none"> <li>• very comfortable saddle cover with a modern, <b>ergonomic design for pressure relief</b></li> <li>• with tensioning cord</li> <li>• with <b>air-cooling</b></li> <li>• on Velo eurohole card</li> </ul>	

ART.-NR. 	BESCHREIBUNG	DESCRIPTION	
<b>137633</b> 100/5	<b>2-FUNKTIONEN-SATTELDECKE</b> <ul style="list-style-type: none"> <li>zum <b>Wenden</b></li> <li>graue Fellimitation für <b>weichen und warmen</b> Sitz und schwarzes Kunstleder als <b>Regenschutz</b></li> <li><b>X-tra breit</b>, ca. 270 x 240 mm (L x B)</li> <li>auf Eurolochkarte</li> </ul>	<b>2-FUNCTION-SADDLE COVER</b> <ul style="list-style-type: none"> <li>useable on <b>two sides</b></li> <li>grey fur imitation for a <b>soft and warm</b> saddle and black leatherette as <b>rain shelter</b></li> <li><b>X-tra wide</b>, approx. 270 x 240 mm (L x W)</li> <li>on eurohole card</li> </ul>	 <p><b>2 in 1!</b></p> <p>UVP 8,90 €</p>
<b>137940</b> 100 <b>NEW</b>	<b>SATTELDECKE ›URBAN‹</b> <ul style="list-style-type: none"> <li><b>20 mm Schaumstoffeinlage</b></li> <li>schwarz mit <b>reflektierenden Seiten</b></li> <li>durch Zugkordel für alle Größen anpassbar</li> <li>auf M-Wave Eurolochkarte</li> </ul>	<b>SADDLE COVER ›URBAN‹</b> <ul style="list-style-type: none"> <li><b>20 mm foam pad</b></li> <li>black with <b>reflective sideparts</b></li> <li>adjustable by drawstring for all sizes</li> <li>on M-Wave eurohole card</li> </ul>	 <p><b>REFLEX</b></p> <p>UVP 6,90 €</p>
<b>137920</b> <b>137921</b> <b>137922</b> <b>137930</b> 100	<b>SATTELDECKE ›FASHION‹</b> <ul style="list-style-type: none"> <li>Universalgröße</li> <li>10 mm <b>Schaumstoffeinlage, eingenäht</b></li> <li>mit <b>Zugkordel</b></li> <li>auf M-Wave Eurolochkarte</li> </ul> <p>›Sunflower‹</p> <p>›Newspaper‹</p> <p>›Ladybird‹</p> <p>›Smile‹</p> <p>Weitere Motive auf Anfrage.</p>	<b>SADDLE COVER ›FASHION‹</b> <ul style="list-style-type: none"> <li>universal size</li> <li>10 mm <b>foam pad, sewn-in</b></li> <li>with <b>cord and stopper</b></li> <li>on M-Wave eurohole card</li> </ul> <p>›Sunflower‹</p> <p>›Newspaper‹</p> <p>›Ladybird‹</p> <p>›Smile‹</p> <p>More motives on request.</p>	 <p>UVP 4,90 €</p>
<b>137908</b> 100/5	<b>SATTELDECKE ›UNIVERSAL‹</b> <ul style="list-style-type: none"> <li>passend für fast alle Touren- und Sport-sättel</li> <li>ca. 245 x 225 mm (L x B)</li> <li><b>20 mm Schaumstoffeinlage</b></li> <li>Ober- und Seitenteil aus PVC</li> <li>farbig sortiert</li> <li>je 5 Stück im Polybeutel</li> </ul>	<b>SADDLE COVER ›UNIVERSAL‹</b> <ul style="list-style-type: none"> <li>available for almost all touring and sports saddles</li> <li>approx. 245 x 225 mm (L x W)</li> <li><b>20 mm foam pad</b></li> <li>top and side part made of PVC</li> <li>assorted colours</li> <li>5 pcs in a PE bag</li> </ul>	 <p>UVP 4,90 €</p>
<b>137400</b> 200/10 <b>NICE PRICE</b>	<b>SATTELDECKE ›MTB + TREKKING‹</b> <ul style="list-style-type: none"> <li><b>schmal</b> für MTB/Trekking-Sättel</li> <li>ca. 270 x 175 mm (L x B)</li> <li>aus <b>strapazierfähigem Nylongewebe</b></li> <li>farbig sortiert</li> <li>nur <b>47 g</b></li> <li><b>20 mm Schaumstoffeinlage</b></li> <li>je 10 Stück im Polybeutel</li> </ul>	<b>SADDLE COVER ›MTB + TREKKING‹</b> <ul style="list-style-type: none"> <li><b>small</b> for MTB/Trekking saddles</li> <li>approx. 270 x 175 mm (L x W)</li> <li><b>hard-wearing nylon mesh</b></li> <li>assorted colours</li> <li>only <b>47 g</b></li> <li><b>20 mm foam pad</b></li> <li>10 pcs in a PE bag</li> </ul>	 <p><b>MADE IN GERMANY</b></p> <p>UVP 4,90 €</p>



M-WAVE

# SEAT POSTS SEAT TUBE CLAMPS



ART.-NR.	BESCHREIBUNG	DESCRIPTION	
<p></p> <p><b>250848</b> <b>250850</b> <b>250851</b> 200</p>	<p><b>SATTELKLEMME MIT GEPÄCKTRÄGERBEFESTIGUNG ›RACKY‹</b></p> <ul style="list-style-type: none"> <li>• Aluminium</li> <li>• nur 36 g (Ø 31,8 mm)</li> <li>• mit Gewindeösen für die Gepäckträgerbefestigung</li> <li>• auf M-Wave Eurolochkarte</li> </ul> <p>Ø 28,6 mm Ø 31,8 mm Ø 34,9 mm</p>	<p><b>SEAT TUBE CLAMP WITH LUGGAGE CARRIER FIXATION ›RACKY‹</b></p> <ul style="list-style-type: none"> <li>• aluminium</li> <li>• only 36 g (Ø 31.8 mm)</li> <li>• with threads for luggage carrier fixation</li> <li>• on M-Wave eurohole card</li> </ul> <p>Ø 28.6 mm Ø 31.8 mm Ø 34.9 mm</p> <p>UVP 8,90 €</p>	
<p><b>250826</b> <b>250827</b> 100</p>	<p><b>SATTELKLEMME</b></p> <ul style="list-style-type: none"> <li>• Aluminium</li> <li>• auf Zoom Eurolochkarte</li> </ul> <ul style="list-style-type: none"> <li>• mit Schnellspanner</li> <li>• nur 41 g (Ø 31,8 mm)</li> </ul> <p>Ø 31,8 mm Ø 34,9 mm</p>	<p><b>SEAT TUBE CLAMP</b></p> <ul style="list-style-type: none"> <li>• aluminium</li> <li>• on Zoom eurohole card</li> </ul> <ul style="list-style-type: none"> <li>• with quick release</li> <li>• only 41 g (Ø 31.8 mm)</li> </ul> <p>Ø 31.8 mm Ø 34.9 mm</p> <p><small>Tested by the manufacturer based on ISO 4210</small></p> <p>UVP 5,90 €</p>	
<p><b>250802</b> <b>250803</b> 100/10</p>	<ul style="list-style-type: none"> <li>• nur 19 g (Ø 31,8 mm)</li> <li>• besonders geeignet für Carbon(sitz-)rohre durch gleichmäßige Klemmung und Druckverteilung</li> <li>• antirostbeschichtete Inbusschraube</li> </ul> <p>Ø 31,8 mm Ø 34,9 mm</p>	<ul style="list-style-type: none"> <li>• only 19 g (Ø 31.8 mm)</li> <li>• especially suitable for carbon tubes and seat tubes by smooth clamping and pressure distribution</li> <li>• anti-rust-coated allen screw</li> </ul> <p>Ø 31.8 mm Ø 34.9 mm</p> <p><small>Tested by the manufacturer based on ISO 4210</small></p> <p>UVP 4,90 €</p>	
<p><b>250986</b> <b>250988</b> <b>250987</b> <b>250941</b> 100</p>	<p><b>SATTELKLEMME ›CLAMPY QR‹</b></p> <ul style="list-style-type: none"> <li>• mit Schnellspanner</li> <li>• Aluminium</li> </ul> <p>auf M-Wave Eurolochkarte</p> <p>Ø 31,8 mm schwarz eloxiert silber eloxiert</p> <p>Ø 34,9 mm schwarz eloxiert silber eloxiert</p>	<p><b>SEAT TUBE CLAMP ›CLAMPY QR‹</b></p> <ul style="list-style-type: none"> <li>• with QR</li> <li>• aluminium</li> </ul> <p>on M-Wave eurohole card</p> <p>Ø 31.8 mm black anodised silver anodised</p> <p>Ø 34.9 mm black anodised silver anodised</p> <p>UVP 4,90 €</p>	
<p>• <b>250895</b> • <b>250897</b> • <b>250896</b> 200/50</p>	<p>in Montageverpackung (ohne Logo)</p> <p>Ø 31,8 mm schwarz eloxiert silber eloxiert</p> <p>Ø 34,9 mm, schwarz eloxiert</p>	<p><b>OEM (w/o logo)</b></p> <p>Ø 31.8 mm black anodised silver anodised</p> <p>Ø 34.9 mm, black anodised</p> <p>UVP 4,90 €</p>	

ART.-NR.	BESCHREIBUNG	DESCRIPTION	
	<b>SATTELKLEMME ›CLAMPY‹</b> Aluminium  auf <b>M-Wave Eurolochkarte</b>  <b>250938</b> Ø 31,8 mm, schwarz eloxiert  <b>250960</b> Ø 34,9 mm, schwarz eloxiert <b>250961</b> Ø 34,9 mm, silber eloxiert 100	<b>SEAT TUBE CLAMP ›CLAMPY‹</b> aluminium  on <b>M-Wave eurohole card</b>  <b>Ø 31.8 mm</b> , black anodised  <b>Ø 34.9 mm</b> black anodised silver anodised  UVP 3,90 €	
<ul style="list-style-type: none"> <li>• <b>250940</b> Ø 28,6 mm</li> <li>• <b>250930</b> Ø 31,8 mm</li> <li>• <b>250931</b> Ø 34,9 mm</li> </ul> 500/100	<ul style="list-style-type: none"> <li>• schwarz eloxiert (ohne Logo)</li> <li>• in <b>Montageverpackung</b></li> </ul>	<ul style="list-style-type: none"> <li>• black anodised (w/o logo)</li> <li>• <b>OEM</b></li> </ul> Ø 28.6 mm Ø 31.8 mm Ø 34.9 mm  UVP 3,90 €	
<b>250976</b> 100	<b>SCHNELLSPANNER FÜR SATTELKLEMMEN</b> <ul style="list-style-type: none"> <li>• Aluminium</li> <li>• nur <b>31 g</b></li> <li>• schwarz</li> <li>• im Polybeutel mit Promax Eurolochheader</li> </ul>	<b>QUICK RELEASE FOR SEAT TUBE CLAMPS</b> <ul style="list-style-type: none"> <li>• aluminium</li> <li>• only <b>31 g</b></li> <li>• black</li> <li>• in PE bag with Promax eurohole header</li> </ul> UVP 4,90 €	
<ul style="list-style-type: none"> <li>• <b>250910</b> silber</li> <li>• <b>250919</b> schwarz</li> </ul> 200/100	<b>SCHNELLSPANNER FÜR SATTELKLEMMEN</b> <ul style="list-style-type: none"> <li>• Aluminium</li> <li>• nur <b>36 g</b></li> <li>• schwarz</li> <li>• Montageverpackung</li> </ul>	<b>QUICK RELEASE FOR SEAT TUBE CLAMPS</b> <ul style="list-style-type: none"> <li>• aluminium</li> <li>• only <b>36 g</b></li> <li>• black</li> <li>• OEM</li> </ul> UVP 1,90 €	

**MOTUL** BIKE CARE



[www.motul.messingschlagler.com](http://www.motul.messingschlagler.com)

# HÖHENVERSTELLBARE SATTELSTÜTZEN DROPPER SEAT POSTS









ART.-NR. 	BESCHREIBUNG	DESCRIPTION	
<p><b>252230</b></p> <p><b>252231</b></p> <p><b>252232</b></p> <p>10</p>	<p><b>HÖHENVERSTELLBARE SATTELSTÜTZE ›LEVITATE C‹</b></p> <ul style="list-style-type: none"> <li>Aluminium</li> <li><b>pneumatische Schnellhöhenverstellung</b> während der Fahrt durch einen <b>Hebel am Lenker</b></li> <li><b>leichtgängige, stufenlose Höhenverstellung</b></li> <li>mit Skala</li> <li>Fahrgewicht bis <b>120 kg</b></li> <li>in M-Wave Eurolochbox</li> </ul> <p>• Ø 27,2 mm • Länge: 390 mm • Höhenverstellung: <b>0 - 105 mm</b></p> <p>• Länge: 400 mm • Höhenverstellung: <b>0 - 125 mm</b></p> <p>Ø 30,9 mm</p> <p>Ø 31,6 mm</p>	<p><b>DROPPER SEAT POST ›LEVITATE C‹</b></p> <ul style="list-style-type: none"> <li>aluminium</li> <li><b>pneumatic quick release height adjustment</b> while riding by a <b>handlebar lever</b></li> <li><b>easy going, stepless height adjustment</b></li> <li>with scale</li> <li>rider's weight up to <b>120 kg</b></li> <li>in M-Wave eurohole box</li> </ul> <p>• Ø 27.2 mm • length: 390 mm • height adjustment: <b>0 - 105 mm</b></p> <p>• length: 400 mm • height adjustment: <b>0 - 125 mm</b></p> <p>Ø 30.9 mm</p> <p>Ø 31.6 mm</p> <p><small>Tested by the manufacturer based on ISO 4210</small></p> <p>UVP 245,00 €</p>	
<p><b>252200</b></p> <p><b>252202</b></p> <p>10</p>	<p><b>HÖHENVERSTELLBARE SATTELSTÜTZE ›LEVITATE IN 125‹</b></p> <ul style="list-style-type: none"> <li>aufgeräumte Zugverlegung durch <b>integrierte Kabelführung</b></li> <li>Aluminium</li> <li><b>pneumatische, stufenlose Schnellhöhenverstellung</b> während der Fahrt durch einen <b>Hebel am Lenker</b></li> <li>mit Skala</li> <li>Länge <b>420 mm</b></li> <li>Höhenverstellung <b>0 - 125 mm</b></li> <li>in M-Wave Eurolochbox</li> </ul> <p>Ø 30,9 mm</p> <p>Ø 31,6 mm</p>	<p><b>DROPPER SEAT POST ›LEVITATE IN 125‹</b></p> <ul style="list-style-type: none"> <li>clean look through <b>integrated cable routing</b></li> <li>aluminium</li> <li><b>pneumatic quick release, stepless height adjustment</b> while riding by a <b>handlebar lever</b></li> <li>with scale</li> <li>length <b>420 mm</b></li> <li>height adjustment <b>0 - 125 mm</b></li> <li>in M-Wave eurohole box</li> </ul> <p>Ø 30.9 mm</p> <p>Ø 31.6 mm</p> <p>UVP 266,00 €</p>	
<p> (Ø 30,9 mm)</p> <p> (Ø 31,6 mm)</p> <p><b>252220</b></p> <p><b>252222</b></p> <p><b>252224</b></p> <p><b>252226</b></p> <p><b>252221</b></p> <p><b>252223</b></p> <p><b>252225</b></p> <p><b>252227</b></p> <p>10</p>	<p><b>HÖHENVERSTELLBARE SATTELSTÜTZE ›LEVITATE IN LT‹</b></p> <ul style="list-style-type: none"> <li>aufgeräumte Zugverlegung durch <b>integrierte Kabelführung</b></li> <li>Aluminium</li> <li><b>pneumatische, stufenlose Schnellhöhenverstellung</b> während der Fahrt durch einen <b>Hebel am Lenker</b>, mit Edelstahlkabel</li> <li>mit Skala</li> </ul> <p>• Länge <b>440 mm</b> • Höhenverstellung <b>0 - 150 mm</b></p> <p>Ø 30,9 mm, in M-Wave Eurolochbox</p> <p>Ø 31,6 mm, in M-Wave Eurolochbox</p> <p>Ø 30,9 mm, Montageverpackung</p> <p>Ø 31,6 mm, Montageverpackung</p> <p>• Länge <b>480 mm</b> • Höhenverstellung <b>0 - 170 mm</b></p> <p>Ø 30,9 mm, in M-Wave Eurolochbox</p> <p>Ø 31,6 mm, in M-Wave Eurolochbox</p> <p>Ø 30,9 mm, Montageverpackung</p> <p>Ø 31,6 mm, Montageverpackung</p>	<p><b>DROPPER SEAT POST ›LEVITATE IN LT‹</b></p> <ul style="list-style-type: none"> <li>clean look through <b>integrated cable routing</b></li> <li>aluminium</li> <li><b>pneumatic quick release, stepless height adjustment</b> while riding by a <b>handlebar lever</b>, with stainless steel cable</li> <li>with scale</li> </ul> <p>• length <b>440 mm</b> • height adjustment <b>0 - 150 mm</b></p> <p>Ø 30.9 mm, in M-Wave eurohole box</p> <p>Ø 31.6 mm, in M-Wave eurohole box</p> <p>Ø 30.9 mm, OEM</p> <p>Ø 31.6 mm, OEM</p> <p>• length <b>480 mm</b> • height adjustment <b>0 - 170 mm</b></p> <p>Ø 30.9 mm, in M-Wave eurohole box</p> <p>Ø 31.6 mm, in M-Wave eurohole box</p> <p>Ø 30.9 mm, OEM</p> <p>Ø 31.6 mm, OEM</p> <p><small>Tested by the manufacturer based on ISO 4210</small></p> <p>UVP 219,00 €</p>	



ART.-NR.	BESCHREIBUNG	DESCRIPTION	
<p><b>252240</b></p> <p><b>252241</b></p> <p>10</p>	<p><b>HÖHENVERSTELLBARE SATTELSTÜTZE ›LEVITATE EX 125‹</b></p> <ul style="list-style-type: none"> <li>• Aluminium</li> <li>• <b>pneumatische Schnellhöhenverstellung während der Fahrt durch einen Hebel am Lenker</b></li> <li>• <b>leichtgängige, stufenlose Höhenverstellung: 0 - 125 mm</b></li> <li>• mit Skala</li> <li>• Fahrergewicht bis <b>120 kg</b></li> <li>• Länge: 475 mm</li> <li>• in M-Wave Eurolochbox</li> </ul> <p>Ø 30,9 mm</p> <p>Ø 31,6 mm</p>	<p><b>DROPPER SEAT POST ›LEVITATE EX 125‹</b></p> <ul style="list-style-type: none"> <li>• aluminium</li> <li>• <b>pneumatic quick release height adjustment while riding by a handlebar lever</b></li> <li>• <b>easy going, stepless height adjustment: 0 - 125 mm</b></li> <li>• with scale</li> <li>• rider's weight up to <b>120 kg</b></li> <li>• length: 475 mm</li> <li>• in M-Wave eurohole box</li> </ul> <p>Ø 30.9 mm</p> <p>Ø 31.6 mm</p> <p><small>Tested by the manufacturer based on ISO 4210</small></p> <p>UVP 159,00 €</p>	
<p><b>252213</b></p> <p><b>252214</b></p> <p><b>252215</b></p> <p>20</p>	<p><b>HÖHENVERSTELLBARE SATTELSTÜTZE ›LEVITATE IN 2‹</b></p> <ul style="list-style-type: none"> <li>• aufgeräumte Zugverlegung durch <b>integrierte Kabelführung</b></li> <li>• Aluminium</li> <li>• <b>hydraulische Schnellhöhenverstellung während der Fahrt durch einen Hebel am Lenker</b></li> <li>• mit Skala</li> <li>• Montageverpackung</li> </ul> <p>• Ø 27,2 mm</p> <p>• Länge: 373 mm</p> <p>• Höhenverstellung: <b>0 - 100 mm</b></p> <p>• Länge: 426 mm</p> <p>• Höhenverstellung: <b>0 - 125 mm</b></p> <p>Ø 30,9 mm</p> <p>Ø 31,6 mm</p>	<p><b>DROPPER SEAT POST ›LEVITATE IN 2‹</b></p> <ul style="list-style-type: none"> <li>• clean look through <b>integrated cable routing</b></li> <li>• aluminium</li> <li>• <b>hydraulic quick release height adjustment while riding by a handlebar lever</b></li> <li>• with scale</li> <li>• OEM</li> </ul> <p>• Ø 27.2 mm</p> <p>• length: 373 mm</p> <p>• height adjustment: <b>0 - 100 mm</b></p> <p>• length: 426 mm</p> <p>• height adjustment: <b>0 - 125 mm</b></p> <p>Ø 30.9 mm</p> <p>Ø 31.6 mm</p> <p><small>Tested by the manufacturer based on ISO 4210</small></p> <p>UVP 136,00 €</p>	
<p><b>252147</b></p> <p>25</p> <p><b>252155</b></p> <p>30</p> <p><b>252148</b></p> <p><b>252156</b></p> <p>25</p>	<p><b>HÖHENVERSTELLBARE SATTELSTÜTZE ›SP110-ADJ‹</b></p> <ul style="list-style-type: none"> <li>• Aluminium</li> <li>• <b>Schnellhöhenverstellung während der Fahrt durch Hebel am Lenker</b></li> <li>• <b>3 Höhenstufen: 0/45/110 mm</b></li> <li>• Länge 445 mm</li> <li>• mit Skala</li> </ul> <p>auf <b>M-Wave Eurolochkarte</b></p> <p>Ø 27,2 mm</p> <p>Ø 31,6 mm</p> <p><b>Montageverpackung</b></p> <p>Ø 27,2 mm</p> <p>Ø 31,6 mm</p>	<p><b>DROPPER SEAT POST ›SP110-ADJ‹</b></p> <ul style="list-style-type: none"> <li>• aluminium</li> <li>• <b>quick release hight adjustment while riding by a handlebar lever</b></li> <li>• <b>3 height steps: 0/45/110 mm</b></li> <li>• length 445 mm</li> <li>• with scale</li> </ul> <p>on <b>M-Wave eurohole card</b></p> <p>Ø 27.2 mm</p> <p>Ø 31.6 mm</p> <p><b>OEM</b></p> <p>Ø 27.2 mm</p> <p>Ø 31.6 mm</p> <p>UVP 129,00 €</p>	

ART.-NR. 	BESCHREIBUNG	DESCRIPTION	
<p><b>250006</b></p> <p><b>250007</b> 10</p>	<p><b>HÖHENVERSTELLBARE SATTELSTÜTZE ›REVERB STEALTH‹</b></p> <ul style="list-style-type: none"> <li>Aluminium</li> <li>pneumatische Schnellhöhenverstellung während der Fahrt durch Hebel am Lenker</li> <li>Vent Valve-Technologie für super einfaches Entlüften, direkt am Bike und ganz ohne Zerlegen der Stütze</li> <li>Standard Remote, rechts oben oder links unten</li> <li>Ø 31,6 mm</li> </ul> <p>Länge: 414 mm Höhenverstellung: 0 - <b>150 mm</b></p> <p>Länge: 467 mm Höhenverstellung: 0 - <b>175 mm</b></p>	<p><b>DROPPER SEAT POST ›REVERB STEALTH‹</b></p> <ul style="list-style-type: none"> <li>aluminium</li> <li>pneumatic quick release height adjustment while riding by a handlebar lever</li> <li>Vent Valve technology for easy handling service without any disassembly of the post</li> <li>standard remote, left below or right above</li> <li>Ø 31.6 mm</li> </ul> <p>length: 414 mm heigth adjustment: 0 - <b>150 mm</b></p> <p>length: 467 mm heigth adjustment: 0 - <b>175 mm</b></p> <p>UVP 499,00 €</p>	<p><b>INFO</b> Weitere Sram-Artikel auf Seite 639-643</p> <p>Further Sram products on page 639-643</p>  <p><b>ROCKSHOX</b></p>
<p></p> <p><b>252176</b></p> <p><b>252197</b></p> <p><b>252177</b></p> <p><b>252180</b></p> <p><b>252182</b></p> <p><b>252181</b> 20</p>	<p><b>GEFEDERTE PARALLELOGRAMMSATTELSTÜTZE ›FOURSPRING‹</b></p> <ul style="list-style-type: none"> <li>einteiliges Aluminiumrohr mit Design-Schutzabdeckung</li> <li>hervorragendes Ansprechverhalten durch Parallelogrammverschiebung (kein Verkanten)</li> <li>Vorspannung einstellbar</li> <li>2-Punkt Befestigung des Sattelgestells, mit <b>Winkelskala</b></li> <li>Federweg: <b>36 mm</b> im Kreisbogen</li> <li>Länge 350 mm</li> <li>mit Skala (Höheneinstellung)</li> <li>mit Originalfeder empfohlen bis 85 kg</li> <li>optional durch Austausch-Federn (Art. 252178, 252165, 252179) für anderes Fahrergewicht anpassbar</li> </ul> <p><b>auf M-Wave Eurolochkarte</b></p> <p>Ø 27,2 mm</p> <p>Ø 30,9 mm</p> <p>Ø 31,6 mm</p> <p><b>Montageverpackung</b></p> <p>Ø 27,2 mm</p> <p>Ø 30,9 mm</p> <p>Ø 31,6 mm</p>	<p><b>PARALLELOGRAM SUSPENSION SEAT POST ›FOURSPRING‹</b></p> <ul style="list-style-type: none"> <li><b>one-piece aluminium</b> tube with <b>design protective cover</b></li> <li><b>very sensitive response characteristic</b> through parallelogram movement (no tilting)</li> <li>preload adjustable</li> <li>2-point fixation of the saddle rails, with <b>angular scale</b></li> <li>travel: <b>36 mm</b> in a circular arc</li> <li>length 350 mm</li> <li>with scale (height adjustment)</li> <li>with original replacement springs recommended up to 85 kg</li> <li>optionally convertible to another driver's weight by replacement springs (art. 252178, 252165, 252179)</li> </ul> <p><b>on M-Wave eurohole card</b></p> <p>Ø 27.2 mm</p> <p>Ø 30.9 mm</p> <p>Ø 31.6 mm</p> <p><b>OEM</b></p> <p>Ø 27.2 mm</p> <p>Ø 30.9 mm</p> <p>Ø 31.6 mm</p> <p>UVP 133,00 €</p>	<p><b>Trekkingbike TIPP</b></p>   <p><b>M-WAVE</b></p>
<p><b>252178</b></p> <p><b>252165</b></p> <p><b>252179</b> 100/50</p>	<p><b>ERSATZ-/TUNING-FEDER</b></p> <ul style="list-style-type: none"> <li>zum Umbau der Sattelstützen Art. 252180-2, 252176/77/97 für ein anderes Fahrergewicht</li> <li>im Polybeutel mit Aufkleber</li> </ul> <p>0 - 70 kg, silber</p> <p>85 - 100 kg, schwarz</p> <p>100 - 120 kg, grün</p>	<p><b>REPLACEMENT-/ TUNING-SPRING</b></p> <ul style="list-style-type: none"> <li>for converting seat post art. 252180-2, 252176/77/97 to another rider's weight</li> <li>in PE bag with sticker</li> </ul> <p>0 - 70 kg, silver</p> <p>85 - 100 kg, black</p> <p>100 - 120 kg, green</p> <p>UVP 8,90 €</p>	<p><b>0 - 120 kg!</b></p> 

ART.-NR.	BESCHREIBUNG	DESCRIPTION	
 <p><b>2</b> 140 kg</p> <p><b>252183</b> <b>252196</b> <b>252184</b></p> <p><b>Montageverpackung</b></p> <ul style="list-style-type: none"> <li>• <b>252185</b></li> <li>• <b>252194</b></li> <li>• <b>252186</b></li> </ul> <p>25</p>	<p><b>PARALLELOGRAMM-SATTELSTÜTZE ›FOURSPRING VARIO‹</b></p> <ul style="list-style-type: none"> <li>• <b>einteiliges Aluminiumrohr</b></li> <li>• <b>hervorragendes Ansprechverhalten</b> durch Parallelogrammverschiebung (kein Verkanten)</li> <li>• <b>schnelle und einfache De-/Montage des Sattels</b></li> <li>• Vorspannung einstellbar</li> <li>• Federweg 20 mm im Kreisbogen</li> <li>• Länge 350 mm</li> <li>• mit Skala</li> <li>• für Fahrergewicht <b>70 bis 90 kg</b> empfohlen</li> <li>• optional durch Austausch-Federn (Art. 252187, 252199) für anderes Fahrergewicht anpassbar</li> </ul> <p>auf <b>M-Wave Eurolochkarte</b></p> <p>Ø 27,2 mm Ø 30,9 mm Ø 31,6 mm</p> <p><b>Montageverpackung</b></p> <p>Ø 27,2 mm Ø 30,9 mm Ø 31,6 mm</p>	<p><b>PARALLELOGRAM SEAT POST ›FOURSPRING VARIO‹</b></p> <ul style="list-style-type: none"> <li>• <b>one-piece aluminium tube</b></li> <li>• <b>very sensitive response characteristic</b> through parallelogram movement (no tilting)</li> <li>• <b>quick and easy dismantling and assembly of the saddle</b></li> <li>• preload adjustable</li> <li>• circular travel 20 mm</li> <li>• length 350 mm</li> <li>• with scale</li> <li>• recommended for drivers weight <b>70 to 90 kg</b></li> <li>• optionally convertible to another driver's weight by replacement springs (art. 252187, 252199)</li> </ul> <p>on <b>M-Wave Eurohole card</b></p> <p>Ø 27.2 mm Ø 30.9 mm Ø 31.6 mm</p> <p><b>OEM</b></p> <p>Ø 27.2 mm Ø 30.9 mm Ø 31.6 mm</p> <p><small>Tested by the manufacturer based on ISO 4210</small></p> <p>UVP 99,90 €</p>	  
<p><b>252187</b> <b>252199</b></p> <p>30</p>	<p><b>ERSATZ-/TUNING-FEDER</b></p> <p>zum Umbau der Sattelstützen Art. 252185/86/94, 252183/84/96 für ein anderes Fahrergewicht</p> <p>50 - 90 kg, silber 90 - 120 kg, schwarz</p>	<p><b>REPLACEMENT-/TUNING-SPRING</b></p> <p>for converting seat post art. 252185/86/94, 252183/84/96 to another rider's weight</p> <p>50 - 90 kg, silver 90 - 120 kg, black</p> <p>UVP 5,90 €</p>	<p><b>0 - 120 kg!</b></p> 
<p><b>252198</b></p> <p>250/10</p>	<p><b>NEOPRENSCHUTZCOVER FÜR PARALLELOGRAM-SATTELSTÜTZEN ›FOURSPRING COVER‹</b></p> <ul style="list-style-type: none"> <li>• <b>schützt vor eingeklemmten Fingern, Witterungsschäden und Schmutz</b></li> <li>• mit <b>universellem Klettverschluss</b></li> <li>• mit <b>reflektierendem Material</b></li> <li>• passend für Art. 252183 ff., ...</li> <li>• auf M-Wave Eurolochkarte</li> </ul>	<p><b>NEOPRENE PROTECTION COVER FOR PARALLELOGRAM SEAT-POSTS ›FOURSPRING COVER‹</b></p> <ul style="list-style-type: none"> <li>• <b>protects from pinched fingers, weather damage and dirt</b></li> <li>• with <b>universal hook and loop fastener</b></li> <li>• with <b>reflective material</b></li> <li>• suitable for art. 252183 et seq., ...</li> <li>• on M-Wave eurole card</li> </ul> <p>UVP 7,90 €</p>	 

ART.-NR. 	BESCHREIBUNG	DESCRIPTION	
<p><b>252324</b></p> <p><b>252325</b></p> <p><b>252326</b></p> <p><b>252327</b></p> <p><b>252328</b></p> <p><b>252329</b></p> <p>25</p>	<p><b>GEFEDERTE SATTELSTÜTZE &gt;SP-C3&lt;</b></p> <ul style="list-style-type: none"> <li>• Aluminium</li> <li>• <b>Spiel einstellbar</b></li> <li>• Länge 350 mm</li> <li>• Federweg 40 mm</li> <li>• Offset: 8 mm</li> <li>• Vorspannung einstellbar</li> <li>• mit Skala</li> </ul> <p><b>auf M-Wave Eurolochkarte</b></p> <p>Ø 27,2 mm</p> <p>Ø 30,9 mm</p> <p>Ø 31,6 mm</p> <p><b>Montageverpackung</b></p> <p>Ø 27,2 mm</p> <p>Ø 30,9 mm</p> <p>Ø 31,6 mm</p>	<p><b>SUSPENSION SEAT POST &gt;SP-C3&lt;</b></p> <ul style="list-style-type: none"> <li>• aluminium</li> <li>• <b>tolerance adjustable</b></li> <li>• length 350 mm</li> <li>• 40 mm travel</li> <li>• offset: 8 mm</li> <li>• preload adjustable</li> <li>• with scale</li> </ul> <p><b>on M-Wave eurohole card</b></p> <p>Ø 27.2 mm</p> <p>Ø 30.9 mm</p> <p>Ø 31.6 mm</p> <p><b>OEM</b></p> <p>Ø 27.2 mm</p> <p>Ø 30.9 mm</p> <p>Ø 31.6 mm</p> <p><small>Tested by the manufacturer based on ISO 4210</small></p> <p>UVP 27,90 €</p>	 
<p><b>252105</b></p> <p><b>252106</b></p> <p><b>252145</b></p> <p><b>252146</b></p> <p><b>252109</b></p> <p><b>252110</b></p> <p><b>252111</b></p> <p>25</p>	<p><b>GEFEDERTE SATTELSTÜTZE</b></p> <ul style="list-style-type: none"> <li>• Aluminium</li> <li>• <b>Spiel einstellbar</b></li> <li>• Länge 350 mm</li> <li>• Federweg 35 mm</li> <li>• Vorspannung einstellbar</li> <li>• mit Skala</li> </ul> <p><b>silber, auf Zoom Eurolochkarte</b></p> <p>Ø 25,4 mm</p> <p>Ø 27,2 mm</p> <p><b>silber, Montageverpackung</b></p> <p>Ø 25,4 mm</p> <p>Ø 27,2 mm</p> <p><b>schwarz, auf Zoom Eurolochkarte</b></p> <p>Ø 27,2 mm</p> <p>Ø 30,9 mm</p> <p>Ø 31,6 mm</p>	<p><b>SUSPENSION SEAT POST</b></p> <ul style="list-style-type: none"> <li>• aluminium</li> <li>• <b>tolerance adjustable</b></li> <li>• length 350 mm</li> <li>• 35 mm travel</li> <li>• preload adjustable</li> <li>• with scale</li> </ul> <p><b>silver, on Zoom eurohole card</b></p> <p>Ø 25.4 mm</p> <p>Ø 27.2 mm</p> <p>UVP 21,90 €</p> <p><b>silver, OEM</b></p> <p>Ø 25.4 mm</p> <p>Ø 27.2 mm</p> <p>UVP 19,90 €</p> <p><b>black, on Zoom eurohole card</b></p> <p>Ø 27.2 mm</p> <p>Ø 30.9 mm</p> <p>Ø 31.6 mm</p> <p>UVP 21,90 €</p> <p><small>Tested by the manufacturer based on ISO 4210</small></p>	  
<p><b>252122</b></p> <p><b>252123</b></p> <p>50</p>	<p><b>GEFEDERTE SATTELSTÜTZE</b></p> <ul style="list-style-type: none"> <li>• Aluminium</li> <li>• Länge 315 mm</li> <li>• Federweg <b>40 mm</b></li> <li>• <b>Vorspannung einstellbar</b></li> <li>• Montageverpackung</li> </ul> <p>Ø 25,4 mm</p> <p>Ø 27,2 mm</p>	<p><b>SUSPENSION SEAT POST</b></p> <ul style="list-style-type: none"> <li>• aluminium</li> <li>• length 315 mm</li> <li>• <b>40 mm travel</b></li> <li>• <b>preload adjustable</b></li> <li>• OEM</li> </ul> <p>Ø 25.4 mm</p> <p>Ø 27.2 mm</p> <p>UVP 14,90 €</p>	 



ART.-NR.	BESCHREIBUNG	DESCRIPTION	
  • <b>252115</b> • <b>252116</b>   <b>252129</b> 50	<b>GEFEDERTE SATTELSTÜTZE</b> <ul style="list-style-type: none"> <li>Aluminium</li> <li>Federweg <b>40 mm</b></li> <li><b>Vorspannung einstellbar</b></li> <li>Montageverpackung</li> </ul> Länge 315 mm  Ø 25,4 mm  Ø 27,2 mm  Länge 300 mm, ohne Logo Ø 27,2 mm	<b>SUSPENSION SEAT POST</b> <ul style="list-style-type: none"> <li>aluminium</li> <li><b>40 mm</b> travel</li> <li><b>preload adjustable</b></li> <li>OEM</li> </ul> length 315 mm  Ø 25.4 mm  Ø 27.2 mm  length 300 mm, without logo Ø 27.2 mm  UVP 15,90 €	 
<b>252018</b> <b>252025</b>  <b>252044</b>  <b>252057</b> <b>252019</b> 50	<b>GEFEDERTE KERZEN-SATTELSTÜTZE</b> <ul style="list-style-type: none"> <li>Aluminium/Stahl</li> <li><b>Spiel einstellbar</b></li> <li>Länge 350 mm</li> <li>Federweg <b>40 mm</b></li> <li><b>Vorspannung einstellbar</b></li> </ul> <b>silber, auf Promax Eurolochkarte</b>  Ø 25,4 mm  Ø 27,2 mm  <b>silber, Montageverpackung</b>  Ø 25,4 mm  <b>schwarz, auf Promax Eurolochkarte</b>  Ø 25,4 mm  Ø 27,2 mm	<b>SUSPENSION SEAT POST</b> <ul style="list-style-type: none"> <li>aluminium/steel</li> <li><b>tolerance adjustable</b></li> <li>length 350 mm</li> <li><b>40 mm</b> travel</li> <li><b>preload adjustable</b></li> </ul> <b>silver, on Zoom eurohole card</b>  Ø 25.4 mm  Ø 27.2 mm  <b>silver, OEM</b>  Ø 25.4 mm  <b>black, on Promax eurohole card</b>  Ø 25.4 mm  Ø 27.2 mm  Tested by the manufacturer based on ISO 4210  UVP 14,90 €	 
• <b>252058</b> 50 • <b>252059</b> 50 <b>252060</b> 45	<b>GEFEDERTE KERZEN-SATTELSTÜTZE</b> <ul style="list-style-type: none"> <li><b>Aluminium</b></li> <li><b>Vorspannung einstellbar</b></li> <li>Länge 300 mm</li> <li>Federweg <b>40 mm</b></li> <li>Montageverpackung</li> </ul> Ø 25,4 mm  Ø 27,2 mm  Ø 27,2 mm, ohne Logo	<b>SUSPENSION SEAT POST</b> <ul style="list-style-type: none"> <li><b>aluminium</b></li> <li><b>preload adjustable</b></li> <li>length 300 mm</li> <li><b>40 mm</b> travel</li> <li>OEM</li> </ul> Ø 25.4 mm  Ø 27.2 mm  Ø 27.2 mm, ohne Logo  Tested by the manufacturer based on ISO 4210  UVP 11,90 €	 

ART.-NR. 	BESCHREIBUNG	DESCRIPTION	
<b>252195</b> 50	<b>SATTELSTÜTZE ›RAPID SWAP‹</b> <ul style="list-style-type: none"> <li>• <b>schneller Sattelwechsel</b> durch <b>Schnellspanner</b></li> <li>• ideal <b>zum Testen verschiedener Sättel</b>, Verleihräder, ...</li> <li>• Aluminium</li> <li>• Länge 350 mm</li> <li>• Ø 27,2 mm (Adapter für andere Durchmesser auf Seite 156)</li> <li>• auf M-Wave Eurolochkarte</li> </ul>	<b>SEAT POST ›RAPID SWAP‹</b> <ul style="list-style-type: none"> <li>• <b>quick saddle change</b> by QR</li> <li>• ideal for <b>testing of various saddles</b>, rental bikes, ...</li> <li>• aluminium</li> <li>• length 350 mm</li> <li>• Ø 27.2 mm (adapters for various diameters on page 156)</li> <li>• on M-Wave eurohole card</li> </ul> <div data-bbox="790 492 1149 761"> <p>1 SEC 1 SEC <b>EASY</b></p> </div>	<div data-bbox="1189 235 1332 291"> <b>IMPROVED VERSION!</b> </div>
<b>252744</b>     <b>252715</b> 25  <b>252745</b> 20	<b>SATTELSTÜTZE</b> <ul style="list-style-type: none"> <li>• <b>einteilige</b> Sattelstütze mit <b>Aluminium-Kopf</b></li> <li>• mit Skala (Höheneinteilung)</li> <li>• einfache Sattelneigeinstellung durch 2-Schrauben-Einstellsystem</li> <li>• Länge <b>400 mm</b></li> <li>• auf Zoom Eurolochkarte</li> </ul>	<b>SEAT POST</b> <ul style="list-style-type: none"> <li>• <b>single piece</b> seat post with <b>aluminium head</b></li> <li>• with scale (height adjustment)</li> <li>• easy saddle angle adjustable with 2 bolts</li> <li>• length <b>400 mm</b></li> <li>• on Zoom eurohole card</li> </ul> <div data-bbox="965 1400 1157 1444"> <small>Tested by the manufacturer based on ISO 4210</small> </div>	
<b>252740</b>     <b>252741</b> 25	<b>SATTELSTÜTZE</b> <ul style="list-style-type: none"> <li>• <b>einteilige</b> Sattelstütze mit <b>Aluminium-Kopf</b></li> <li>• mit Skala (Höheneinteilung)</li> <li>• einfache Sattelneigeinstellung durch 2-Schrauben-Einstellsystem</li> <li>• nur <b>254 g</b> (Ø 27,2 mm)</li> <li>• Länge 350 mm</li> <li>• auf Zoom Eurolochkarte</li> </ul>	<b>SEAT POST</b> <ul style="list-style-type: none"> <li>• <b>single piece</b> seat post with <b>aluminium head</b></li> <li>• with scale (height adjustment)</li> <li>• easy saddle angle adjustable with 2 bolts</li> <li>• only <b>254 g</b> (Ø 27.2 mm)</li> <li>• length 350 mm</li> <li>• on Zoom eurohole card</li> </ul> <div data-bbox="1181 1534 1252 1624"> <p>254 g</p> </div> <div data-bbox="965 2060 1157 2105"> <small>Tested by the manufacturer based on ISO 4210</small> </div>	

ART.-NR.	BESCHREIBUNG	DESCRIPTION	
			
	<b>SATTELSTÜTZE</b> <ul style="list-style-type: none"> <li>• mit <b>Aluminium-Kopf</b></li> <li>• zweiteilig</li> <li>• mit Skala (Höheneinteilung)</li> <li>• einfache Sattelneigeinstellung durch 2-Schrauben-Einstellsystem</li> <li>• Länge 350 mm</li> <li>• auf Zoom Eurolochkarte</li> </ul>	<b>SEAT POST</b> <ul style="list-style-type: none"> <li>• with <b>aluminium head</b></li> <li>• two-part</li> <li>• with scale (height adjustment)</li> <li>• easy saddle angle adjustment with 2 bolts</li> <li>• length 350 mm</li> <li>• on Zoom eurohole card</li> </ul>	  
<b>252757</b>	Ø 27,2 mm	Ø 27.2 mm	<p>Tested by the manufacturer based on ISO 4210</p> <p>UVP 19,90 €</p>
<b>252789</b>	Ø 30,9 mm	Ø 30.9 mm	
<b>252759</b>	Ø 31,6 mm	Ø 31.6 mm	
20			
	<b>SATTELSTÜTZE ›A 350 STRONG‹</b> <ul style="list-style-type: none"> <li>• mit <b>Aluminium-Kopf</b></li> <li>• einfache Sattelneigeinstellung durch 2-Schrauben-Einstellsystem</li> <li>• Offset: 15 mm</li> <li>• Länge 350 mm</li> </ul> <p><b>auf M-Wave Eurolochkarte</b></p>	<b>SEAT POST ›A 350 STRONG‹</b> <ul style="list-style-type: none"> <li>• with <b>aluminium head</b></li> <li>• easy saddle angle adjustable with 2 bolts</li> <li>• offset: 15 mm</li> <li>• length 350 mm</li> </ul> <p><b>on M-Wave eurohole card</b></p>	  
<b>252831</b>	Ø 27,2 mm	Ø 27.2 mm	<p>OEM</p> <p>UVP 15,90 €</p>
<b>252833</b>	Ø 30,9 mm	Ø 30.9 mm	
<b>252835</b>	Ø 31,6 mm	Ø 31.6 mm	
	<p><b>Montageverpackung</b></p> <ul style="list-style-type: none"> <li>• <b>252830</b> Ø 27,2 mm</li> <li>• <b>252832</b> Ø 30,9 mm</li> <li>• <b>252834</b> Ø 31,6 mm</li> </ul>		
50			
	<b>SATTELSTÜTZE</b> <ul style="list-style-type: none"> <li>• mit <b>Aluminium-Kopf</b></li> <li>• Länge <b>350 mm</b></li> <li>• Montageverpackung</li> </ul> <p><b>schwarz</b></p> <ul style="list-style-type: none"> <li>• <b>252426</b> Ø 25,4 mm</li> <li>• <b>252427</b> Ø 27,2 mm</li> <li>• <b>252428</b> Ø 28,6 mm</li> </ul> <p><b>silber</b></p> <ul style="list-style-type: none"> <li>• <b>252423</b> Ø 25,4 mm</li> <li>• <b>252425</b> Ø 27,2 mm</li> </ul>	<b>SEAT POST</b> <ul style="list-style-type: none"> <li>• with <b>aluminium head</b></li> <li>• length <b>350 mm</b></li> <li>• OEM</li> </ul> <p><b>black</b></p> <ul style="list-style-type: none"> <li>• <b>252426</b> Ø 25.4 mm</li> <li>• <b>252427</b> Ø 27.2 mm</li> <li>• <b>252428</b> Ø 28.6 mm</li> </ul> <p><b>silver</b></p> <ul style="list-style-type: none"> <li>• <b>252423</b> Ø 25.4 mm</li> <li>• <b>252425</b> Ø 27.2 mm</li> </ul>	  
			<p>Tested by the manufacturer based on ISO 4210</p> <p>UVP 9,90 €</p>
50			

# SATTELSTÜTZEN / SATTELSTÜTZADAPTER SEAT POSTS / SEAT POST ADAPTER

ART.-NR. 	BESCHREIBUNG	DESCRIPTION	
	<p><b>SATTELSTÜTZADAPTER</b></p> <ul style="list-style-type: none"> <li>• Aluminium</li> <li>• Länge 80 mm</li> <li>• 10 Stück im Polybeutel</li> </ul> <p><b>silber</b></p> <p><b>I-Ø 25,4 mm</b></p> <p><b>259944</b> A-Ø 26,4 mm</p> <p><b>259941</b> A-Ø 26,6 mm</p> <p><b>259946</b> A-Ø 26,8 mm</p> <p><b>259943</b> A-Ø 27,0 mm</p> <p><b>I-Ø 27,2 mm</b></p> <p><b>259950</b> A-Ø 28,6 mm</p> <p><b>259951</b> A-Ø 29,2 mm</p> <p><b>259954</b> A-Ø 29,8 mm</p> <p><b>259955</b> A-Ø 30,0 mm</p> <p><b>259956</b> A-Ø 30,2 mm</p> <p><b>259959</b> A-Ø 30,9 mm</p> <p><b>259957</b> A-Ø 31,4 mm</p> <p><b>259929</b> A-Ø 31,6 mm</p> <p><b>259958</b> A-Ø 31,8 mm</p> <p><b>schwarz</b></p> <p><b>259960</b> I-Ø 31,6 mm A-Ø 34,9 mm 200/10</p>	<p><b>SEAT POST ADAPTER</b></p> <ul style="list-style-type: none"> <li>• aluminium</li> <li>• length 80 mm</li> <li>• 10 pieces in PE bag</li> </ul> <p><b>silver</b></p> <p><b>I-Ø 25.4 mm</b></p> <p>O-Ø 26.4 mm</p> <p>O-Ø 26.6 mm</p> <p>O-Ø 26.8 mm</p> <p>O-Ø 27.0 mm</p> <p><b>I-Ø 27.2 mm</b></p> <p>O-Ø 28.6 mm</p> <p>O-Ø 29.2 mm</p> <p>O-Ø 29.8 mm</p> <p>O-Ø 30.0 mm</p> <p>O-Ø 30.2 mm</p> <p>O-Ø 30.9 mm</p> <p>O-Ø 31.4 mm</p> <p>O-Ø 31.6 mm</p> <p>O-Ø 31.8 mm</p> <p>UVP 2,90 €</p> <p><b>black</b></p> <p>I-Ø 31,6 mm O-Ø 34,9 mm</p> <p>UVP 3,90 €</p>	 
<p><b>252065</b> 100</p>	<p><b>KERZENSATTELSTÜTZEN</b></p> <ul style="list-style-type: none"> <li>• Aluminium</li> <li>• Länge 330 mm</li> <li>• Ø 27,2 mm</li> </ul>	<p><b>SEAT POSTS</b></p> <ul style="list-style-type: none"> <li>• aluminium</li> <li>• length 330 mm</li> <li>• Ø 27.2 mm</li> </ul> <p>UVP 4,90 €</p>	<p><b>ALUMINIUM</b></p> 
<p><b>252681</b></p> <p><b>252682</b> 50</p>	<ul style="list-style-type: none"> <li>• Stahl</li> <li>• verzinkt</li> <li>• Ø 25,4 mm</li> </ul> <p>Länge 240 mm</p> <p>Länge 330 mm</p>	<ul style="list-style-type: none"> <li>• steel</li> <li>• u.c.p.</li> <li>• Ø 25.4 mm</li> </ul> <p>length 240 mm</p> <p>length 330 mm</p> <p>UVP 2,90 €</p>	
<p><b>252690</b> 50</p>	<ul style="list-style-type: none"> <li>• Stahl</li> <li>• schwarz</li> <li>• Länge 300 mm</li> <li>• Ø 27,2 mm</li> </ul> <p>weitere <b>Längen, Durchmesser, Material</b> (Aluminium, Nirosta, ...) und <b>Finish</b> (verchromt, schwarz, ...) auf Anfrage</p>	<ul style="list-style-type: none"> <li>• steel</li> <li>• black</li> <li>• length 300 mm</li> <li>• Ø 27.2 mm</li> </ul> <p>other <b>lengths, diameter, material</b> (aluminium, stainless steel, ...) and <b>finish</b> (c.p., black, ...) on request</p> <p>UVP 2,90 €</p>	









Art. 259856



# BABY SEATS

# KINDERSITZE BABY SEATS

ART.-NR.	BESCHREIBUNG	DESCRIPTION	
<b>SITZROHR-MONTAGE</b>			<b>SEAT TUBE MOUNTING</b>
	<p><b>LIEGE-KINDERSITZ</b></p> <ul style="list-style-type: none"> <li>• mit <b>Universal-Schnellbefestigungssystem am Sitzrohr</b> (rund Ø 25 - 46 mm und oval Ø 30 - 60 mm)</li> <li>• mit Adapter-Schrauben für Oversize-Rahmen</li> <li>• <b>stufenlos verstellbar</b> zwischen <b>Sitz- und Liegeposition</b></li> <li>• empfohlen für Kinder bis 6 Jahre</li> <li>• Belastbarkeit max. 22 kg</li> <li>• <b>TÜV/GS geprüft, gemäß DIN EN 14344</b></li> </ul> <p><b>259854</b></p> <ul style="list-style-type: none"> <li>• <b>neigungs- und höhenverstellbare Rückenlehne</b></li> <li>• mit <b>Fünfpunkt-Sicherheitsgurt</b></li> </ul> <p><b>259851</b></p> <ul style="list-style-type: none"> <li>• <b>Neigung verstellbar</b></li> <li>• mit <b>Dreipunkt-Sicherheitsgurt</b></li> </ul>	<p><b>RECLINABLE BABY SEAT</b></p> <ul style="list-style-type: none"> <li>• with <b>universal quick mounting system on seat tube</b> (round Ø 25 - 46 mm and oval Ø 30 - 60 mm)</li> <li>• with adapter screws for oversize frames</li> <li>• <b>infinitely variable</b> from <b>seat to lying position</b></li> <li>• for kids up to 6 years</li> <li>• max. weight 22 kg</li> <li>• <b>TÜV/GS approved, according to DIN EN 14344</b></li> </ul> <p>• <b>incline and height adjustable seat back</b></p> <p>• with <b>5-point safety belt</b></p> <p>UVP 149,00 €</p> <p>• <b>adjustable inclination</b></p> <p>• with <b>3-point safety belt</b></p> <p>UVP 99,90 €</p>	 
	<p><b>KINDERSITZ FÜR SITZROHR</b></p> <ul style="list-style-type: none"> <li>• mit <b>Universal-Schnellbefestigungssystem am Sitzrohr</b> (rund Ø 25 - 46 mm und oval Ø 30 - 60 mm)</li> <li>• mit Adapter-Schrauben für Oversize-Rahmen</li> <li>• empfohlen für Kinder bis 6 Jahre</li> <li>• Belastbarkeit max. 22 kg</li> <li>• <b>TÜV/GS geprüft, gemäß DIN EN 14344</b></li> </ul> <p><b>259853</b></p> <ul style="list-style-type: none"> <li>• <b>höhenverstellbare Rückenlehne</b></li> <li>• mit <b>Fünfpunkt-Sicherheitsgurt</b></li> </ul> <p><b>259852</b></p> <ul style="list-style-type: none"> <li>• fixe Rückenlehne</li> <li>• mit <b>Dreipunkt-Sicherheitsgurt</b></li> </ul>	<p><b>BABY SEAT FOR SEAT TUBE</b></p> <ul style="list-style-type: none"> <li>• with <b>universal quick mounting system on seat tube</b> (round Ø 25 - 46 mm and oval Ø 30 - 60 mm)</li> <li>• with adapter screws for oversize frames</li> <li>• for kids up to 6 years</li> <li>• max. weight 22 kg</li> <li>• <b>TÜV/GS approved, according to DIN EN 14344</b></li> </ul> <p>• <b>height adjustable seat back</b></p> <p>• with <b>5-point safety belt</b></p> <p>UVP 129,00 €</p> <p>• <b>fix seat back</b></p> <p>• with <b>3-point safety belt</b></p> <p>UVP 71,90 €</p>	 



# KINDERSITZE BABY SEATS

ART.-NR.	BESCHREIBUNG	DESCRIPTION	
			
	<b>KINDERSITZ FÜR SITZROHR ›LIGHT‹</b> <ul style="list-style-type: none"> <li>mit <b>Universal-Schnellbefestigungs-System am Sitzrohr</b> (rund Ø 25 - 46 mm und oval Ø 30 - 60 mm)</li> <li>mit Adapter-Schrauben für Oversize-rahmen</li> <li>empfohlen für Kinder bis 5 Jahre</li> <li>Belastbarkeit max. 22 kg</li> <li>mit <b>Dreipunkt-Sicherheitsgurt</b></li> <li><b>TÜV/GS geprüft, gemäß DIN EN 14344</b></li> </ul>	<b>BABY SEAT FOR SEAT TUBE ›LIGHT‹</b> <ul style="list-style-type: none"> <li>with <b>universal quick mounting system on seat tube</b> (round Ø 25 - 46 mm and oval Ø 30 - 60 mm)</li> <li>with adapter screws for oversize frame</li> <li>for kids up to 5 years</li> <li>max. weight 22 kg</li> <li>with <b>3-point safety belt</b></li> <li><b>TÜV/GS approved, according to DIN EN 14344</b></li> </ul>	
259855	blau	blue	UVP 64,90 €
259873	<b>auffallende, neongelbe</b> Signalfarbe und Reflektor auf der Rückseite	<b>remarkable, neon yellow</b> signal colour and reflector on backside	UVP 71,90 €
4			

## GEPÄCKTRÄGER-MONTAGE

## CARRIER MOUNTING

259850	<b>KINDERSITZ FÜR GEPÄCKTRÄGER</b> <ul style="list-style-type: none"> <li>mit <b>Schnellverschluss</b> zur Befestigung am <b>Gepäckträger</b></li> <li>Klemme auch für breite Gepäckträger <b>für E-Bike</b> Akkus (bis zu 185 mm) geeignet</li> <li>mit Adapter-Schrauben für Oversize-rahmen</li> <li>empfohlen für Kinder bis 5 Jahre</li> <li>Belastbarkeit max. 22 kg</li> <li>mit <b>Dreipunkt-Sicherheitsgurt</b></li> <li><b>TÜV/GS geprüft, gemäß DIN EN 14344</b></li> </ul>	<b>BABY SEAT FOR CARRIER</b> <ul style="list-style-type: none"> <li>with <b>QR</b> for mounting on <b>rear carrier</b></li> <li>clamp also suitable for wide carriers <b>for e-bike</b> batteries (up to 185 mm)</li> <li>with adapter screws for oversize frame</li> <li>for kids up to 5 years</li> <li>max. weight 22 kg</li> <li>with <b>3-point safety belt</b></li> <li><b>TÜV/GS approved, according to DIN EN 14344</b></li> </ul>	  <p><b>E-BIKE BATTERY CARRIER UP TO 185 MM</b></p>
3			UVP 79,90 €
259856	<b>KINDERSITZ FÜR GEPÄCKTRÄGER ›LIGHT‹</b> <ul style="list-style-type: none"> <li>mit <b>Schnellverschluss</b> zur Befestigung am <b>Gepäckträger</b></li> <li>Klemme auch für breite Gepäckträger <b>für E-Bike</b> Akkus (bis zu 185 mm) geeignet</li> <li>empfohlen für Kinder bis 5 Jahre</li> <li>Belastbarkeit max. 22 kg</li> <li>mit <b>Dreipunkt-Sicherheitsgurt</b></li> <li><b>TÜV/GS geprüft, gemäß DIN EN 14344</b></li> </ul>	<b>BABY SEAT FOR CARRIER ›LIGHT‹</b> <ul style="list-style-type: none"> <li>with <b>QR</b> for mounting on <b>rear carrier</b></li> <li>clamp also suitable for wide carriers <b>for e-bike</b> batteries (up to 185 mm)</li> <li>for kids up to 5 years</li> <li>max. weight 22 kg</li> <li>with <b>3-point safety belt</b></li> <li><b>TÜV/GS approved, according to DIN EN 14344</b></li> </ul>	  <p><b>E-BIKE BATTERY CARRIER UP TO 185 MM</b></p>
4			UVP 64,90 €

# KINDERSITZE BABY SEATS

ART.-NR.	BESCHREIBUNG	DESCRIPTION	
<b>MONTAGE VORNE</b>		<b>FRONT MOUNTING</b>	
259859 5	<b>KINDERSITZ FÜR VORNE ›LIGHT F‹</b> <ul style="list-style-type: none"> <li>• <b>Schnellbefestigungssystem am Steuersatzrohr oder Vorbau</b></li> <li>• empfohlen für Kinder bis 4 Jahre</li> <li>• Belastbarkeit max. 15 kg</li> <li>• mit <b>Dreipunkt-Sicherheitsgurt</b></li> <li>• <b>TÜV/GS geprüft, gemäß DIN EN 14344</b></li> </ul>	<b>BABY SEAT FOR FRONT ›LIGHT F‹</b> <ul style="list-style-type: none"> <li>• <b>quick mounting system on head tube or stem</b></li> <li>• for kids up to 4 years</li> <li>• max. weight 15 kg</li> <li>• with <b>3-point safety belt</b></li> <li>• <b>TÜV/GS approved, according to DIN EN 14344</b></li> </ul>	  <p>UVP 51,90 €</p>
259825 24	<b>ERSATZ-/ZWEITHALTERUNG</b> <ul style="list-style-type: none"> <li>• für Kindersitz Art. 259851/2/3/4/5/73</li> <li>• mit zusätzlichen Adapterschrauben für <b>Oversizerahmen</b></li> <li>• im Einzelkarton</li> </ul>	<b>REPLACEMENT BRACKET</b> <ul style="list-style-type: none"> <li>• for baby seat art. 259851/2/3/4/5/73</li> <li>• with adaptor screws for <b>oversize-frames</b></li> <li>• in box</li> </ul>	  <p>UVP 24,90 €</p>
259891 50 <b>NEW</b>	<b>KINDER-REGENPONCHO ›PONCHO KID N´SEAT‹</b> <ul style="list-style-type: none"> <li>• passend für <b>alle gängigen Kindersitze</b></li> <li>• geeignet für <b>Kinder von 6 Monaten bis 5 Jahren</b></li> <li>• mit Ärmeln für optimale Bewegungsfreiheit</li> <li>• auch zur Abdeckung des Kindersitzes geeignet</li> <li>• mit reflektierenden Elementen</li> <li>• im Polybeutel mit Euroloch</li> </ul>	<b>RAIN COVER FOR CHILDREN SEAT ›PONCHO KID N´SEAT‹</b> <ul style="list-style-type: none"> <li>• suitable for <b>all common child seats</b></li> <li>• suitable for <b>children from 6 months to 5 years</b></li> <li>• with sleeves for optimal freedom of movement</li> <li>• also useable for covering the baby seat</li> <li>• with reflective elements</li> <li>• in PE bag with eurohole</li> </ul>	  <p>UVP 34,90 €</p>











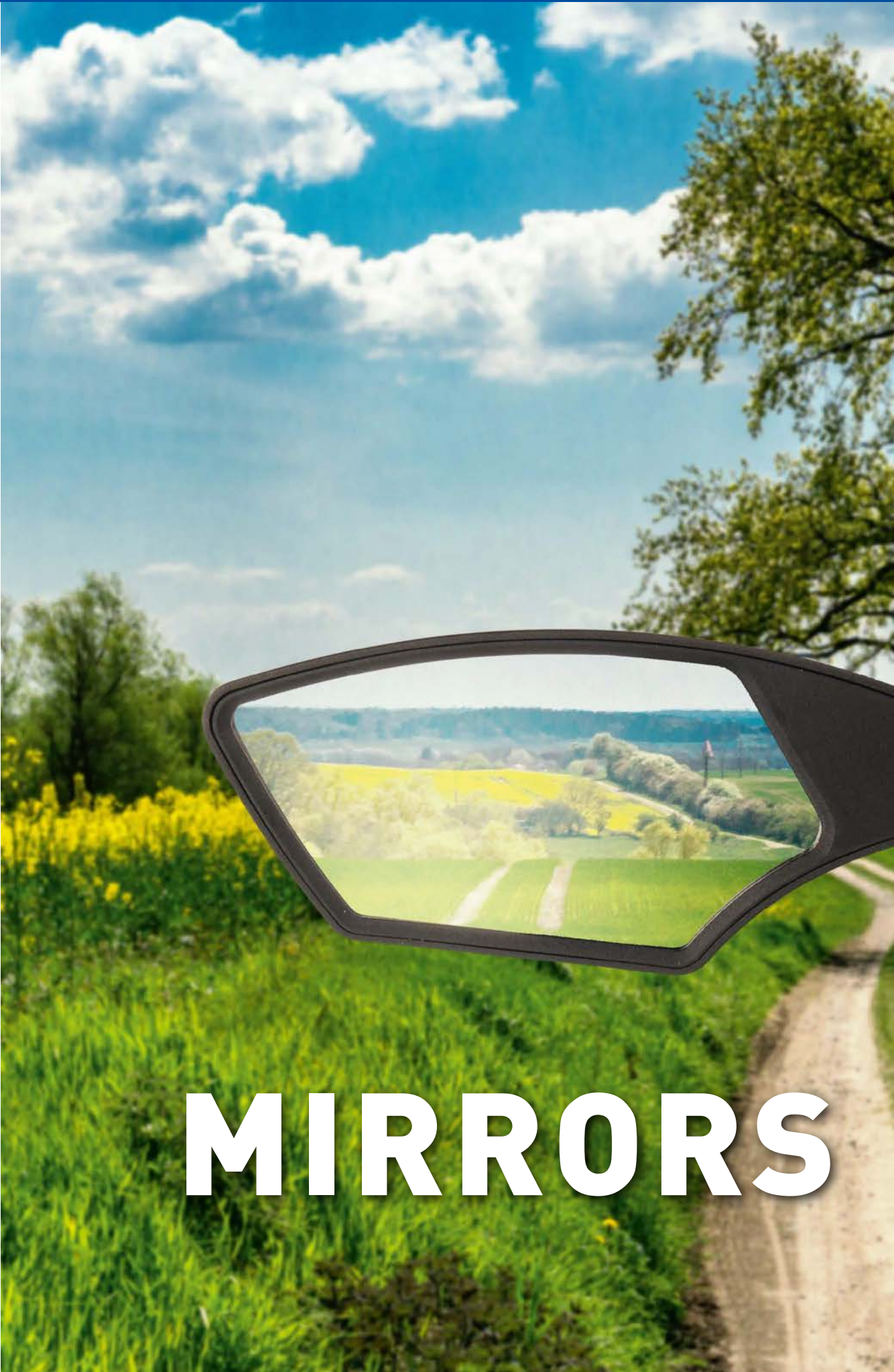





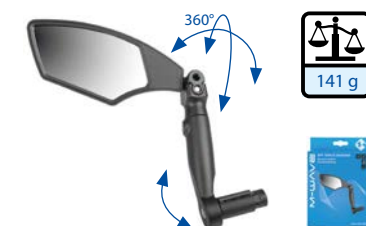

[www.trailgator.messingschlager.com](http://www.trailgator.messingschlager.com)























# MIRRORS



ART.-NR.	BESCHREIBUNG	DESCRIPTION	
<p><b>270015</b></p> <p><b>270016</b></p> <p>50</p>	<p><b>FAHRRADSPIEGEL</b></p> <ul style="list-style-type: none"> <li>• <b>3-dimensional verstellbar</b></li> <li>• <b>gestochen scharfes, entspiegeltes, schlagfestes und blendfreies Echtglas</b></li> <li>• sehr beständiges Gehäuse aus <b>Nylonfasern</b></li> <li>• Aluminiumschelle Ø 22,2 mm</li> <li>• sehr leicht, nur ca. <b>137 g</b></li> <li>• in M-Wave Eurolochbox</li> </ul> <p>›SPY SPACE‹</p> <p>zur Montage an der <b>linken</b> Seite</p> <p>zur Montage an der <b>rechten</b> Seite</p>	<p><b>BICYCLE MIRROR</b></p> <ul style="list-style-type: none"> <li>• <b>3-dimensionally adjustable</b></li> <li>• <b>high definition, antireflective, blast resistant and glare-free genuine glass</b></li> <li>• high impact <b>nylon fiber</b> frame</li> <li>• aluminium clamp Ø 22.2 mm</li> <li>• very light, only approx. <b>137 g</b></li> <li>• in M-Wave eurohole box</li> </ul> <p>›SPY SPACE‹</p> <p>for mounting at the <b>left</b> side</p> <p>for mounting at the <b>right</b> side</p>	 <p><b>Elektro Rad</b> SEHR GUT 1/2008</p> <p> 137 g</p> 
<p><b>270019</b></p> <p>50</p>	<p>›SPY SPACE BAREND‹</p> <p>für Montage am <b>linken Lenkerende</b></p>	<p>›SPY SPACE BAREND‹</p> <p>for mounting on <b>left handlebar end</b></p>	 <p> 141 g</p> 
<p><b>270014</b></p> <p>50</p>	<p><b>FAHRRADSPIEGEL</b></p> <p>›SPY SPACE IN XL‹</p> <ul style="list-style-type: none"> <li>• <b>3-dimensional verstellbar</b></li> <li>• Montage links</li> <li>• <b>gestochen scharfes, entspiegeltes, schlagfestes und blendfreies Echtglas</b></li> <li>• sehr beständiges Gehäuse aus <b>Nylonfasern</b></li> <li>• ca. Ø 80 mm Spiegelfläche</li> <li>• passend für Ø 17-22 mm Lenkerinnendurchmesser</li> <li>• auf M-Wave Eurolochkarte</li> </ul>	<p><b>BICYCLE MIRROR</b></p> <p>›SPY SPACE IN XL‹</p> <ul style="list-style-type: none"> <li>• <b>3-dimensionally adjustable</b></li> <li>• left side mounting</li> <li>• <b>high definition, antireflective, blast resistant and glare-free genuine glass</b></li> <li>• high impact <b>nylon fiber</b> frame</li> <li>• approx. Ø 80 mm mirror surface</li> <li>• suitable for Ø 17-22 mm inner bar diameter</li> <li>• on M-Wave eurohole card UVP 21,90 €</li> </ul>	 
<p><b>270017</b></p> <p>100</p>	<p><b>FAHRRADSPIEGEL</b></p> <p>›SPY SPACE IN‹</p> <ul style="list-style-type: none"> <li>• <b>3-dimensional verstellbar</b></li> <li>• <b>universelle</b> Montage <b>rechts und links</b> möglich</li> <li>• <b>gestochen scharfes, entspiegeltes, schlagfestes und blendfreies Echtglas</b></li> <li>• sehr beständiges Gehäuse aus <b>Nylonfasern</b></li> <li>• sehr stabile Befestigung, teilweise aus <b>Aluminium</b></li> <li>• für Lenker und Lenkerzusatzgriffe mit Ø 16 – 22 mm Innendurchmesser</li> <li>• auf M-Wave Eurolochkarte</li> </ul>	<p><b>BICYCLE MIRROR</b></p> <p>›SPY SPACE IN‹</p> <ul style="list-style-type: none"> <li>• <b>3-dimensionally adjustable</b></li> <li>• <b>universal</b> mounting at <b>left and right side</b> possible</li> <li>• <b>high definition, antireflective, blast resistant and glare-free genuine glass</b></li> <li>• high impact <b>nylon fiber</b> frame</li> <li>• very stable mounting, partially made of <b>aluminium</b></li> <li>• for handlebars and bar ends with Ø 16 – 22 mm inner diameter</li> <li>• on M-Wave eurohole card UVP 23,90 €</li> </ul>	 
<p><b>270071</b></p> <p>50</p>	<p><b>FAHRRADSPIEGEL</b></p> <p>›SPY SPACE 45 COMPACT‹</p> <ul style="list-style-type: none"> <li>• <b>ECE geprüft:</b> für alle Fahrzeuge der Klasse L, die keine den Fahrer umschließende Karosserie aufweisen, z. B. <b>geeignet für E-Bikes, S-Pedelecs</b> bis 45 km/h Maximalgeschwindigkeit, <b>Mofas, Motorräder, Quads, ...</b></li> <li>• <b>3-dimensional verstellbar</b></li> <li>• <b>gestochen scharfes, entspiegeltes, schlagfestes und blendfreies Echtglas</b></li> <li>• sehr beständiges Gehäuse aus <b>Nylonfasern</b></li> <li>• Aluminiumschelle Ø 22,2 mm</li> <li>• nur 161 g</li> <li>• in M-Wave Eurolochbox</li> </ul>	<p><b>BICYCLE MIRROR</b></p> <p>›SPY SPACE 45 COMPACT ‹</p> <ul style="list-style-type: none"> <li>• <b>ECE approved:</b> for all class L vehicles which do not have a bodywork surrounding the driver, e. g. <b>suitable for E-Bikes, S-Pedelecs</b> up to 45 km/h maximum speed, <b>mopeds, motorcycles, quads, ...</b></li> <li>• <b>3-dimensionally adjustable</b></li> <li>• <b>high definition, antireflective, blast resistant and glare-free genuine glass</b></li> <li>• high impact <b>nylon fiber</b> frame</li> <li>• aluminium clamp Ø 22.2 mm</li> <li>• only 161 g</li> <li>• in M-Wave eurohole box UVP 32,90 €</li> </ul>	<p><b>ECE APPROVED</b></p>   



ART.-NR.	BESCHREIBUNG	DESCRIPTION	
<b>270070</b> 50	<b>FAHRRADSPIEGEL ›SPY SPACE 45‹</b> <ul style="list-style-type: none"> <li>• <b>ECE geprüft:</b> für alle Fahrzeuge der Klasse L, die keine den Fahrer umschließende Karosserie aufweisen, z. B. <b>geeignet für E-Bikes, S-Pedelecs</b> bis 45 km/h Maximalgeschwindigkeit, <b>Mofas, Motorräder, Quads, ...</b></li> <li>• <b>3-dimensional verstellbar</b></li> <li>• <b>blendfreies Echtglas</b></li> <li>• zur Montage am Lenkerende links mit Innen-Ø 14,5 - 16,5 mm und Ø 18 - 19,5 mm</li> <li>• in M-Wave Blisterverpackung</li> </ul>	<b>BICYCLE MIRROR ›SPY SPACE 45‹</b> <ul style="list-style-type: none"> <li>• <b>ECE approved:</b> for all class L vehicles which do not have a bodywork surrounding the driver, e. g. <b>suitable for E-Bikes, S-Pedelecs</b> up to 45 km/h maximum speed, <b>mopeds, motorcycles, quads, ...</b></li> <li>• <b>3-dimensionally adjustable</b></li> <li>• <b>glare-free genuine glass</b></li> <li>• for mounting on handlebar ends left side with inner Ø 14.5 - 16.5 mm and Ø 18 - 19.5 mm</li> <li>• in M-Wave blister packaging</li> </ul> <p style="text-align: right;">UVP 21,90 €</p>	<div style="border: 1px solid black; padding: 2px; display: inline-block;">ECE APPROVED</div>   
<b>270060</b> 100	<b>FAHRRADSPIEGEL ›SPY FLEX‹</b> <ul style="list-style-type: none"> <li>• <b>mit flexiblem Schwanenhals</b> zum schnellen Drehen oder Verstellen</li> <li>• <b>3-dimensional verstellbarer Konvexspiegel</b></li> <li>• Gesamtlänge ca. 315 mm</li> <li>• ca. Ø 70 mm Spiegelfläche</li> <li>• Klemmschelle Ø 21 - 30 mm</li> <li>• auf M-Wave Eurolochkarte</li> </ul>	<b>BICYCLE MIRROR ›SPY FLEX‹</b> <ul style="list-style-type: none"> <li>• <b>with flexible rod</b> for quick turning or adjustment</li> <li>• <b>3-dimensionally adjustable convex mirror</b></li> <li>• total length approx. 315 mm</li> <li>• approx. Ø 70 mm mirror surface</li> <li>• clamp Ø 21 - 30 mm</li> <li>• on M-Wave eurohole card</li> </ul> <p style="text-align: right;">UVP 12,90 €</p>	 <div style="border: 1px solid black; padding: 2px; display: inline-block;">FLEXIBLE</div> 
<b>270061</b> 100	<b>FAHRRADSPIEGEL ›SPY FLEX TF‹</b> <ul style="list-style-type: none"> <li>• <b>mit flexiblem Schwanenhals</b> zum schnellen Drehen oder Verstellen</li> <li>• <b>3-dimensional verstellbarer Konvexspiegel</b></li> <li>• Gesamtlänge ca. 375 mm</li> <li>• ca. Ø 80 mm Spiegelfläche</li> <li>• <b>werkzeuglose Montage</b> mit Ø 21 - 30 mm Klemme</li> <li>• auf M-Wave Eurolochkarte</li> </ul>	<b>BICYCLE MIRROR ›SPY FLEX TF‹</b> <ul style="list-style-type: none"> <li>• <b>with flexible rod</b> for quick turning or adjustment</li> <li>• <b>3-dimensionally adjustable convex mirror</b></li> <li>• total length approx. 375 mm</li> <li>• approx. Ø 80 mm mirror surface</li> <li>• <b>toolless mounting</b> with clamp for Ø 21 - 30 mm</li> <li>• on M-Wave eurohole card</li> </ul> <p style="text-align: right;">UVP 11,90 €</p>	 <div style="border: 1px solid black; padding: 2px; display: inline-block;">FLEXIBLE</div> 
<b>270080</b> 100/10	<b>FAHRRADSPIEGEL ›SPY BASE‹</b> <ul style="list-style-type: none"> <li>• <b>3-dimensional verstellbar</b></li> <li>• variable Einstellmöglichkeiten</li> <li>• <b>konvexe und blendfreie</b> Spiegelfläche (ca. 105 x 70 mm)</li> <li>• <b>superleicht</b>, nur <b>99 g</b></li> <li>• Klemmschelle Ø 22,2 mm, ohne Demontage von Griff, ... montierbar</li> <li>• Länge: ca. 300 mm</li> <li>• auf M-Wave Eurolochkarte</li> </ul>	<b>BICYCLE MIRROR ›SPY BASE‹</b> <ul style="list-style-type: none"> <li>• <b>3-dimensionally adjustable</b></li> <li>• variable adjustment possibilities</li> <li>• <b>convex and glare-free</b> mirror surface (approx. 105 x 70 mm)</li> <li>• <b>super light</b>, only <b>99 g</b></li> <li>• clamp Ø 22.2 mm, mountable without demounting of grip, ...</li> <li>• length: approx. 300 mm</li> <li>• on M-Wave eurohole card</li> </ul> <p style="text-align: right;">UVP 10,90 €</p>	 <div style="border: 1px solid black; padding: 2px; display: inline-block;">  99 g         </div> 

ART.-NR. 	BESCHREIBUNG	DESCRIPTION	
<b>270028</b> 120/20	<b>FAHRRADSPIEGEL</b> <ul style="list-style-type: none"> <li>• universeller, <b>3-dimensional verstellbarer Konvexspiegel</b></li> <li>• ca. Ø 46 mm</li> <li>• <b>universeller</b> Gummizughalter zur <b>werkzeuglosen Montage</b> am Lenker, Vorbau, Lenkerzusatzgriff, Rahmen, ...</li> <li>• auf M-Wave Eurolochkarte</li> </ul>	<b>BICYCLE MIRROR</b> <ul style="list-style-type: none"> <li>• universal, <b>3-dimensionally adjustable convex mirror</b></li> <li>• approx. Ø 46 mm</li> <li>• <b>universal</b> rubber bracket for <b>toolless mounting</b> on handlebar, handle stem, bar end, frame, ...</li> <li>• on M-Wave eurohole card</li> </ul>	
<b>270034</b> 100/10	<b>FAHRRADSPIEGEL ›SPY MINI SHORT‹</b>	<b>BICYCLE MIRROR ›SPY MINI SHORT‹</b>	
<b>270020</b> 100/10	<b>FAHRRADSPIEGEL ›SPY MAXI‹</b> <ul style="list-style-type: none"> <li>• <b>3-dimensional verstellbarer Konvexspiegel</b></li> <li>• ca. Ø 76 mm</li> <li>• für Montage am Lenkerende oder Lenkerzusatzgriff</li> <li>• auf M-Wave Eurolochkarte</li> </ul>	<b>BICYCLE MIRROR ›SPY MAXI‹</b> <ul style="list-style-type: none"> <li>• <b>3-dimensionally adjustable convex mirror</b></li> <li>• approx. Ø 76 mm</li> <li>• for mounting on handlebar end or bar end</li> <li>• on M-Wave eurohole card</li> </ul>	
<b>270029</b> 200/40	<b>FAHRRADSPIEGEL ›SPY MICRO‹</b> <ul style="list-style-type: none"> <li>• universeller, <b>3-dimensional verstellbarer Konvexspiegel</b></li> <li>• ca. Ø 35 mm</li> <li>• für Montage am Lenkerende oder Lenkerzusatzgriff</li> <li>• <b>werkzeuglos montierbar</b></li> <li>• schwarz</li> <li>• auf M-Wave Eurolochkarte</li> </ul>	<b>BICYCLE MIRROR ›SPY MICRO‹</b> <ul style="list-style-type: none"> <li>• universal, <b>3-dimensionally adjustable convex mirror</b></li> <li>• approx. Ø 35 mm</li> <li>• for mounting on handlebar end or bar end</li> <li>• <b>toolless mounting</b></li> <li>• black</li> <li>• on M-Wave eurohole card</li> </ul>	
<b>270032</b> 100	<b>FAHRRADSPIEGEL ›SPY OVAL‹</b> <ul style="list-style-type: none"> <li>• <b>3-dimensional</b> verstellbar</li> <li>• für <b>werkzeuglose Montage</b> am Lenkerende oder Lenkerzusatzgriff</li> <li>• mit <b>2 Haltern</b> für unterschiedliche Lenkerdurchmesser</li> <li>• ca. 75 x 50 mm</li> <li>• schwarz</li> <li>• auf M-Wave Eurolochkarte</li> </ul>	<b>BICYCLE MIRROR ›SPY OVAL‹</b> <ul style="list-style-type: none"> <li>• <b>3-dimensionally</b> adjustable</li> <li>• for <b>toolless mounting</b> on handlebar end or bar end</li> <li>• with <b>2 holders</b> for different handlebar diameters</li> <li>• approx. 75 x 50 mm</li> <li>• black</li> <li>• on M-Wave eurohole card</li> </ul>	



ART.-NR. 	BESCHREIBUNG	DESCRIPTION	
<b>270011</b> 200	<b>FAHRRADSPIEGEL</b> <ul style="list-style-type: none"> <li>• <b>3-dimensional</b> verstellbar</li> <li>• Befestigung am Lenkerende oder Lenkerzusatzgriff durch Innenklemmung</li> <li>• Montage auf <b>linker und rechter Seite</b> möglich</li> <li>• Gesamtlänge ca. 132 mm</li> <li>• ca. Ø 78 mm Spiegelfläche</li> <li>• Montageverpackung</li> </ul>	<b>BICYCLE MIRROR</b> <ul style="list-style-type: none"> <li>• <b>3-dimensionally</b> adjustable</li> <li>• mounting on handlebar end or bar end by internal clamping</li> <li>• mounting at <b>left and right side</b> possible</li> <li>• total length approx. 132 mm</li> <li>• approx. Ø 78 mm mirror surface</li> <li>• OEM</li> </ul>	
<b>270002</b> 200/20	<b>FAHRRADSPIEGEL</b> <ul style="list-style-type: none"> <li>• <b>3-dimensional</b> verstellbar durch flexible Stange</li> <li>• mit integriertem Frontreflektor</li> <li>• ca. Ø 84 mm</li> <li>• schwarz</li> <li>• mit Schelle</li> <li>• Montageverpackung</li> </ul>	<b>BICYCLE MIRROR</b> <ul style="list-style-type: none"> <li>• <b>3-dimensionally</b> adjustable with flexible rod</li> <li>• with integrated front reflector</li> <li>• approx. Ø 84 mm</li> <li>• black</li> <li>• with clamp</li> <li>• OEM</li> </ul>	
<b>271354</b> 50 Set	<b>FAHRRADSPIEGEL</b> <b>›ANTI-GLARE‹</b> <ul style="list-style-type: none"> <li>• <b>blendfreies</b> Glas</li> <li>• ca. Ø 105 mm</li> <li>• Kopf und Stange schwarz</li> <li>• Stange ca. 300 x 10 mm</li> <li>• mit einstellbarer Befestigungsschelle</li> <li>• <b>2 Stück</b> im Trumpf Karton</li> </ul>	<b>BICYCLE MIRROR</b> <b>›ANTI-GLARE‹</b> <ul style="list-style-type: none"> <li>• <b>anti-glare</b> glass</li> <li>• approx. Ø 105 mm</li> <li>• head and rod black</li> <li>• rod approx. 300 x 10 mm</li> <li>• with adjustable special clamp</li> <li>• <b>2 pieces</b> in Trumpf box</li> </ul>	
<b>270908</b> 60 Set	<b>FAHRRADSPIEGEL</b> <b>›ANTI-GLARE CP‹</b> <ul style="list-style-type: none"> <li>• <b>blendfreies</b> Glas</li> <li>• schwarzer Kunststoffkopf</li> <li>• ca. Ø 105 mm</li> <li>• Stange verchromt</li> <li>• Stange ca. 300 x 8 mm</li> <li>• mit Befestigungsschelle</li> <li>• <b>2 Stück</b> im Trumpf Karton</li> </ul>	<b>BICYCLE MIRROR</b> <b>›ANTI-GLARE CP‹</b> <ul style="list-style-type: none"> <li>• <b>anti-glare</b> glass</li> <li>• head made of black plastic</li> <li>• approx. Ø 105 mm</li> <li>• rod c. p.</li> <li>• rod approx. 300 x 8 mm</li> <li>• with clamp</li> <li>• <b>2 pieces</b> in Trumpf box</li> </ul>	
<b>271018</b> 100/10	<b>FAHRRADSPIEGEL</b> <ul style="list-style-type: none"> <li>• ca. Ø 80 mm</li> <li>• verchromt</li> <li>• mit verstellbarer Stange</li> <li>• ca. 220 mm lang</li> <li>• Montageverpackung</li> </ul>	<b>BICYCLE MIRROR</b> <ul style="list-style-type: none"> <li>• approx. Ø 80 mm</li> <li>• c. p.</li> <li>• with adjustable rod</li> <li>• approx. 220 mm long</li> <li>• OEM</li> </ul>	

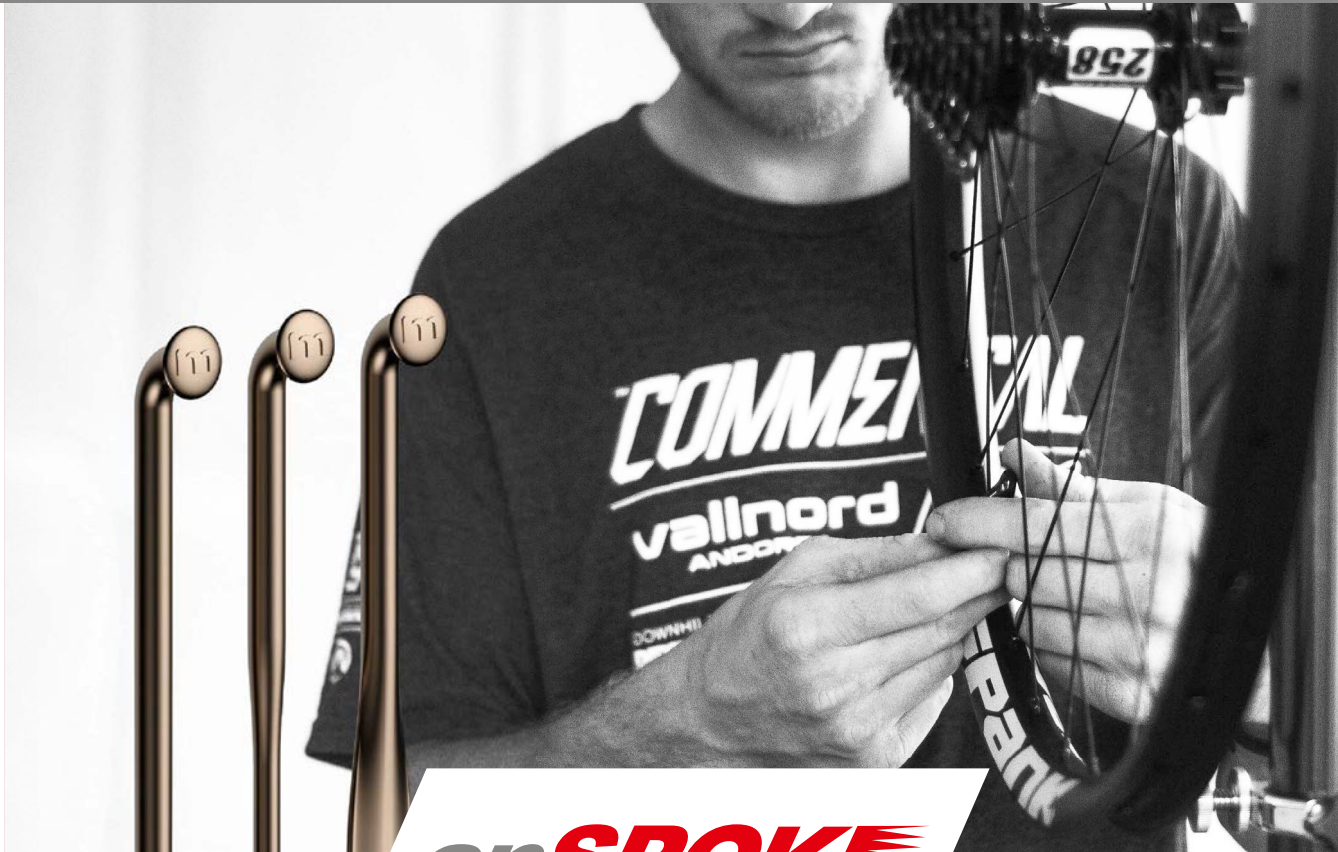

# cnSPOKE

## Speichen auf höchstem Standard

cnSpoke, 1970 gegründet, baut als renommierter und erfahrener Hersteller Speichen auf höchstem Industrienniveau und setzt dabei einzigartige Fertigungstechniken ein. Zertifizierte Produktionsstandards garantieren höchste Zuverlässigkeit der teilweise außergewöhnlichen Produkte. Ein Spitzenprodukt sind beispielsweise Speichen ab 2,77 Gramm, auf die auch Topathleten vertrauen.

- + Maximal belastbare Speichen
- + Geformte Speichengewinde

*geschnitten*



*geformt*



## Spokes on the highest standard

cnSpoke, founded in 1970, builds spokes at the highest industrial level as a well-known and experienced manufacturer and uses unique manufacturing techniques. Certified production standards guarantee the highest reliability of the partially extraordinary products. A top product is, for example, spokes from 2.77 grams, which many top athletes trust.

- + Maximal loadable spokes
- + Shaped spoke thread

*cut*



*shaped*

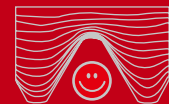

## 30 Millionen Speichen auf Lager

Ca. 30 Millionen CN-Speichen in verschiedenen Varianten und Längen stehen in unserem Zentral-lager in Baunach/Deutschland permanent zur Verfügung. Wir verfügen damit über einen der größten Lagerbestände an Speichen in Europa.

- + Zahlreiche Größen ständig auf Lager
- + Schnelle Verfügbarkeit
- + Eines der größten Speichenlager in Europa

## 30 million of spokes in stock

Approximately 30 million CN-spokes in different variations and lengths are permanently available in our central warehouse in Baunach/Germany. Therefore, we have one of the largest stocks for spokes in Europe.

- + Numerous sizes permanently on stock
- + Quick availability
- + One of the largest stocks for spokes in Europe

 = 3.000, Innverpackung 500 in Box    = 3,000, inner packaging 500 in box



GLANZVERZINKT/UCP		EDELSTAHL/STAINLESS		
Ø 2 mm	Länge / length	Ø 2 mm	Ø 2,3 mm	Black Ø 2 mm
<b>280082</b>	176 mm	<b>283347</b>		
<b>280083</b>	177 mm	<b>283300</b>		
<b>280071</b>	178 mm	<b>283346</b>		
<b>280084</b>	179 mm	<b>283234</b>		
<b>280067</b>	180 mm			
<b>283280</b>	181 mm			
<b>283249</b>	182 mm			
<b>283281</b>	183 mm	<b>283150</b>		
<b>283730</b>	184 mm	<b>283344</b>		
<b>283727</b>	185 mm	<b>284679</b>		
<b>283279</b>	186 mm	<b>283343</b>		
<b>283282</b>	187 mm			
	188 mm	<b>283342</b>		
	189 mm	<b>283157</b>		
<b>283728</b>	190 mm	<b>283366</b>		
<b>283122</b>	191 mm	<b>283611</b>		
<b>280069</b>	192 mm	<b>283367</b>		
<b>280086</b>	193 mm	<b>283158</b>		
<b>280070</b>	194 mm			
<b>283773</b>	229 mm	<b>283612</b>		
	230 mm			
<b>283754</b>	231 mm	<b>283619</b>		
	232 mm	<b>280053</b>		
<b>283284</b>	233 mm	<b>283340</b>		
<b>283757</b>	234 mm	<b>283609</b>		
<b>283285</b>	235 mm	<b>284616</b>		
<b>283286</b>	236 mm	<b>280054</b>		
<b>280087</b>	237 mm	<b>283613</b>		
<b>283287</b>	238 mm			
<b>280088</b>	239 mm	<b>283187</b>		
<b>280061</b>	240 mm	<b>280055</b>		
<b>283288</b>	241 mm	<b>283188</b>		
<b>280089</b>	242 mm	<b>280066</b>		
<b>280072</b>	243 mm	<b>283104</b>		
<b>280090</b>	244 mm			
<b>280091</b>	245 mm	<b>283105</b>		
	246 mm			
	247 mm	<b>283614</b>		
	248 mm	<b>283248</b>		

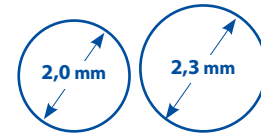

Die aufgeführten Speichenlängen führen wir am Lager. Selbstverständlich liefern wir Ihnen auf Anfrage auch jede andere gewünschte Länge. Unter anderem produziert cnSpoke auch leichte 1,8 mm Ø (15 G) Speichen, mit denen Sie eine Gewichtsersparnis von 1,17 g (bei 272 mm) pro Speiche erzielen.

These spokes are normally on stock. Of course it is possible to deliver every other length. Among others cnSpoke also produces light 1.8 mm Ø (15 G) spokes. With these you can realize a weight reduction of 1.17 g (at length 272 mm) per spoke.



= 3.000, Innenverpackung 500 in Box

= 3,000, inner packaging 500 in box



GLANZVERZINKT/UCP		EDELSTAHL/STAINLESS			
Ø 2 mm	Länge / length	Ø 2 mm	Ø 2,3 mm	Black Ø 2 mm	Black Ø 2,3 mm XD scratch resistant
280093	250 mm	283305		283581	
	251 mm	283589		283422	
280094	252 mm	283510		283560	
	253 mm	283106		283556	
283761	254 mm	283511		283561	
	255 mm	283456		283555	
283762	256 mm	283512		283562	
	257 mm			283554	
280230	258 mm	283526	283848	283577	
	259 mm	283838		283553	
283763	260 mm	283513	283153	283563	
	261 mm	283525	283154	283552	
280232	262 mm	283514	283849	283564	
	263 mm	283840	283862	283551	
283764	264 mm	283515	283155	283565	
	265 mm	283516	283864	283566	
283765	266 mm	284623		284658	
	267 mm				
280075	268 mm	283528		284659	
	269 mm			283424	
283209	270 mm	284600		284607	283960
	271 mm	283190		283457	
280236	272 mm	283222		283549	283961
	273 mm	283225		283458	
283771	274 mm	283223		283459	283962
	275 mm	283226		283425	
280237	276 mm	283227		283460	283963
	277 mm	283228		283461	
280238	278 mm	283229	283878	283558	283964
	279 mm	284638		283462	
280040	280 mm	284625	283877	283559	283965
	281 mm	283247	280018	283440	
280243	282 mm	283307	283865	283578	283966
	283 mm	283548	283107	283421	
280041	284 mm	283517	283866	283567	283967
	285 mm	283250	283108	284669	
283772	286 mm	283518	283867	283568	283968
	287 mm	284628	283109	284670	
280244	288 mm	280050		283576	283969
	289 mm	284629	283845	283463	
280042	290 mm	283519	283869	283569	283970

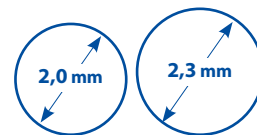

Die aufgeführten Speichenlängen führen wir am Lager. Selbstverständlich liefern wir Ihnen auf Anfrage auch jede andere gewünschte Länge. Unter anderem produziert cnSpoke auch leichte 1,8 mm Ø (15 G) Speichen, mit denen Sie eine Gewichtsersparnis von 1,17 g (bei 272 mm) pro Speiche erzielen.

These spokes are normally on stock. Of course it is possible to deliver every other length. Among others cnSpoke also produces light 1.8 mm Ø (15 G) spokes. With these you can realize a weight reduction of 1.17 g (at length 272 mm) per spoke.





= 3.000, Innenverpackung 500 in Box

= 3,000, inner packaging 500 in box



GLANZVERZINKT/UCP		EDELSTAHL/STAINLESS		
Ø 2 mm	Länge / length	Ø 2 mm	Ø 2,3 mm	Black Ø 2 mm
<b>280247</b>	291 mm	<b>283191</b>	<b>283110</b>	<b>283464</b>
<b>283767</b>	292 mm	<b>283520</b>	<b>283870</b>	<b>283570</b>
	293 mm	<b>283521</b>	<b>283871</b>	<b>283571</b>
<b>280248</b>	294 mm	<b>283309</b>	<b>283872</b>	<b>283585</b>
<b>283769</b>	295 mm	<b>283522</b>	<b>283873</b>	<b>283572</b>
<b>283770</b>	296 mm	<b>283523</b>	<b>283874</b>	<b>283573</b>
<b>280249</b>	297 mm	<b>284633</b>	<b>283860</b>	<b>283441</b>
	298 mm	<b>283524</b>	<b>283875</b>	<b>283574</b>
<b>280250</b>	299 mm	<b>284634</b>	<b>283111</b>	<b>283426</b>
<b>280251</b>	300 mm	<b>280052</b>	<b>280016</b>	<b>283540</b>
<b>280252</b>	301 mm	<b>283251</b>	<b>280017</b>	<b>283427</b>

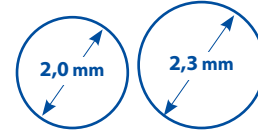

Die aufgeführten Speichenlängen führen wir am Lager. Selbstverständlich liefern wir Ihnen auf Anfrage auch jede andere gewünschte Länge. Unter anderem produziert cnSpoke auch leichte 1,8 mm Ø (15 G) Speichen, mit denen Sie eine Gewichtersparnis von 1,17 g (bei 272 mm) pro Speiche erzielen.

These spokes are normally on stock. Of course it is possible to deliver every other length.

Among others cnSpoke also produces light 1.8 mm Ø (15 G) spokes. With these you can realize a weight reduction of 1.17 g (at length 272 mm) per spoke.

ART.-NR.	BESCHREIBUNG	DESCRIPTION
<b>289996</b>	<b>BESCHICHTUNGS-AUFPREISE</b> • extrem <b>kratzfeste ION-Farb-beschichtung</b> • widersteht <b>1.000 Stunden Salz-sprühstest</b> • erhältlich für Mac 14, Aero und konifizierte Speichen	<b>UPCHARGES FOR COATING</b> • extrem <b>scratch resistant coloured ION coating</b> • withstands <b>1,000 hrs salt spray test</b> • available for Mac 14, Aero and butted spokes
<b>289980</b>	schwarze, <b>kratzfeste XD Beschichtung</b>	black, <b>scratch resistant XD finish</b>
<b>289994</b>	<b>farbige Pulverbeschichtung</b> (für Nirosta)	<b>coloured powdercoating</b> (for stainless)
<b>289993</b>	ED-Farb-beschichtung	coloured ED coating
	Mindestbestellmenge 1.000 Stück Bei größeren Mengen fragen Sie bitte Sonderpreis und Lieferzeit an.	Minimum quantity 1,000 pcs. For higher quantities please ask for special price and delivery date.

scratch resistance  
\* \* \* \*

scratch resistance  
\* \* \*

scratch resistance  
\* \*

scratch resistance  
\*

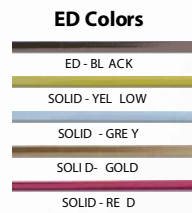

ART.-NR.	BESCHREIBUNG	DESCRIPTION
<b>284760</b> (260 mm)	<b>MAC 14</b> Perfektioniert die 2 mm-Nirosta-Speiche durch Auswahl <b>höchstqualitativen</b> Materials mit <b>optimiertem Fertigungsprozess</b> <ul style="list-style-type: none"> <li>dauerhaft <b>resistent gegen Längung</b></li> <li>sehr <b>hohe Bruchfestigkeit</b></li> <li>alle Längen zum gleichen Preis</li> <li>silber</li> </ul>	<b>MAC 14</b> This spoke type perfects the 2 mm stainless spokes by choosing <b>top quality</b> material for an <b>optimized manufacturing process</b> <ul style="list-style-type: none"> <li>permanently <b>resistant to elongation</b></li> <li>very <b>high break strength</b></li> <li>all lengths the same price</li> <li>silver</li> </ul>



TIP		NIROSTA SPEICHEN ›AERO 424‹	STAINLESS SPOKES ›AERO 424‹																																																						
		<ul style="list-style-type: none"> <li>Ø A 2,0, Ø BxW 0,9 x 2,2, Ø C 2,0 mm</li> <li>schwarze, <b>kratzfeste XD Beschichtung</b></li> </ul>	<ul style="list-style-type: none"> <li>Ø A 2.0, Ø BxW 0.9 x 2.2, Ø C 2.0 mm</li> <li>black, <b>scratch resistant XD finish</b></li> </ul>																																																						
		<div style="display: flex; justify-content: space-between;"> <div style="border: 1px solid black; padding: 5px;"> <b>scratch resistance</b> ***         </div> <div style="border: 1px solid black; padding: 5px;"> <b>4,07 g</b> (260 mm)         </div> </div>																																																							
		<table border="1"> <thead> <tr> <th>Art. Nr.</th> <th>Länge / length</th> <th>Art. Nr.</th> <th>Länge / length</th> <th>Art. Nr.</th> <th>Länge / length</th> </tr> </thead> <tbody> <tr> <td><b>283360</b></td> <td>254 mm</td> <td><b>287124</b></td> <td>270 mm</td> <td><b>287119</b></td> <td>286 mm</td> </tr> <tr> <td><b>283361</b></td> <td>256 mm</td> <td><b>287125</b></td> <td>272 mm</td> <td><b>287115</b></td> <td>288 mm</td> </tr> <tr> <td><b>287109</b></td> <td>258 mm</td> <td><b>287114</b></td> <td>274 mm</td> <td><b>287116</b></td> <td>290 mm</td> </tr> <tr> <td><b>287110</b></td> <td>260 mm</td> <td><b>287143</b></td> <td>276 mm</td> <td><b>287117</b></td> <td>292 mm</td> </tr> <tr> <td><b>287111</b></td> <td>262 mm</td> <td><b>283364</b></td> <td>278 mm</td> <td><b>287118</b></td> <td>294 mm</td> </tr> <tr> <td><b>287112</b></td> <td>264 mm</td> <td><b>285103</b></td> <td>280 mm</td> <td><b>287123</b></td> <td>296 mm</td> </tr> <tr> <td><b>287113</b></td> <td>266 mm</td> <td><b>285100</b></td> <td>282 mm</td> <td><b>287181</b></td> <td>298 mm</td> </tr> <tr> <td><b>287138</b></td> <td>268 mm</td> <td><b>285101</b></td> <td>284 mm</td> <td></td> <td></td> </tr> </tbody> </table>		Art. Nr.	Länge / length	Art. Nr.	Länge / length	Art. Nr.	Länge / length	<b>283360</b>	254 mm	<b>287124</b>	270 mm	<b>287119</b>	286 mm	<b>283361</b>	256 mm	<b>287125</b>	272 mm	<b>287115</b>	288 mm	<b>287109</b>	258 mm	<b>287114</b>	274 mm	<b>287116</b>	290 mm	<b>287110</b>	260 mm	<b>287143</b>	276 mm	<b>287117</b>	292 mm	<b>287111</b>	262 mm	<b>283364</b>	278 mm	<b>287118</b>	294 mm	<b>287112</b>	264 mm	<b>285103</b>	280 mm	<b>287123</b>	296 mm	<b>287113</b>	266 mm	<b>285100</b>	282 mm	<b>287181</b>	298 mm	<b>287138</b>	268 mm	<b>285101</b>	284 mm		
Art. Nr.	Länge / length	Art. Nr.	Länge / length	Art. Nr.	Länge / length																																																				
<b>283360</b>	254 mm	<b>287124</b>	270 mm	<b>287119</b>	286 mm																																																				
<b>283361</b>	256 mm	<b>287125</b>	272 mm	<b>287115</b>	288 mm																																																				
<b>287109</b>	258 mm	<b>287114</b>	274 mm	<b>287116</b>	290 mm																																																				
<b>287110</b>	260 mm	<b>287143</b>	276 mm	<b>287117</b>	292 mm																																																				
<b>287111</b>	262 mm	<b>283364</b>	278 mm	<b>287118</b>	294 mm																																																				
<b>287112</b>	264 mm	<b>285103</b>	280 mm	<b>287123</b>	296 mm																																																				
<b>287113</b>	266 mm	<b>285100</b>	282 mm	<b>287181</b>	298 mm																																																				
<b>287138</b>	268 mm	<b>285101</b>	284 mm																																																						





INFO		
Alle Speichen auf Wunsch auch mit <b>geradem Kopf</b> zum gleichen Preis erhältlich!	All spokes also with <b>straight pull</b> available on request for the same price!	<div style="border: 1px solid black; padding: 5px;"> <b>STRAIGHT PULL</b> </div>

880071	ZENTRIERSTÄNDER ›TB-PF 30‹	TRUING STAND ›TB-PF 30‹
2	<ul style="list-style-type: none"> <li>professioneller Zentrierständer für <b>höchste Präzision</b></li> <li>für <b>12"-29"</b> Laufräder</li> <li>auch für Boost, Plus, ... Laufräder geeignet durch Öffnungsbreite bis 165 mm</li> <li>mit <b>zwei analogen Messuhren</b> mit einer <b>Genauigkeit von 0,01 mm</b></li> <li><b>maximale Flexibilität</b> bei der Messung durch <b>frei verstellbare, extra lange Messarme</b> (Art. 880171)</li> <li>auch zur <b>Seitenschlagmessung von Bremscheiben</b> geeignet</li> <li>inkl. <b>Steckachsadaptern</b> für 15 und 20 mm Achsen</li> <li>an der Werkbank fest montierbar</li> <li>im Super B Einzelkarton</li> </ul>	<ul style="list-style-type: none"> <li>professional truing stand for <b>highest precision</b></li> <li>for <b>12"-29"</b> wheels</li> <li>also suitable for Boost, Plus, ... wheel sets by opening width up to 165 mm</li> <li>with <b>two analogue dial indicators</b> with <b>0.01 mm tolerance</b></li> <li><b>maximum flexibility</b> for measuring through <b>all-purpose, extra long and easy to adjust indicator arms</b> (art. 880171)</li> <li>also usable for <b>truing brake discs</b></li> <li>incl. <b>adapters</b> for 15 and 20 mm thru axles</li> <li>can be fixed at the workbench</li> <li>in Super B box</li> </ul> <p style="text-align: right;">UVP 749,00 €</p>



880069	ZENTRIERSTÄNDER	WHEEL TRUING STAND
5	<ul style="list-style-type: none"> <li>für <b>12"-29"</b> Laufräder</li> <li><b>selbsttätiges Mittigstellen</b> beim Einspannen des Laufrades</li> <li>simultane Kontrolle des <b>Höhen- und Seitenschlages</b> möglich</li> <li><b>Aluminium/Stahl</b></li> <li><b>zusammenklappbar</b></li> <li>hochwertige Verarbeitung</li> </ul>	<ul style="list-style-type: none"> <li>for <b>12"-29"</b> wheels</li> <li>clamps the wheel <b>centric</b> by <b>self-acting</b></li> <li>simultaneous control of the <b>height and side tolerances</b> possible</li> <li><b>aluminium/steel</b></li> <li><b>foldable</b></li> <li>high-grade manufacturing</li> </ul> <p style="text-align: right;">UVP 146,00 €</p>



ART.-NR.	BESCHREIBUNG	DESCRIPTION	
<b>880074</b> 6 set	<b>ZENTRIERSTÄNDER</b> <b>›TB-PF25‹</b> <ul style="list-style-type: none"> <li>für <b>16" - 29"</b> Laufräder</li> <li><b>automatische Mittigstellung</b> beim Einspannen des Laufrades</li> <li>simultane Kontrolle des Höhen- und <b>Seitenschlages</b> möglich</li> <li>umstellbar von 100 mm auf 130/135 mm</li> <li><b>Aluminium/Stahl</b></li> <li><b>zusammenklappbar</b></li> <li>im Super B Einzelkarton</li> </ul>	<b>WHEEL TRUING STAND</b> <b>›TB-PF25‹</b> <ul style="list-style-type: none"> <li>for <b>16" - 29"</b> wheels</li> <li>clamps the wheel <b>centric automatically</b></li> <li>simultaneous control of the height and <b>side tolerances</b> possible</li> <li>can be switched from 100 mm to 130/135 mm</li> <li><b>aluminium/steel</b></li> <li><b>foldable</b></li> <li>in Super B box</li> </ul>	
<b>880167</b> 5	<b>SPEICHENSPANNUNGS-MESSGERÄT</b> <b>›TB-ST11‹</b> <ul style="list-style-type: none"> <li>mit <b>Präzisionsmessuhr</b> für den professionellen Laufradbau</li> <li>im Super B Einzelkarton</li> </ul>	<b>SPOKE TENSIONMETER</b> <b>›TB-ST11‹</b> <ul style="list-style-type: none"> <li>with <b>high precision dial gauge</b> for professional wheel building</li> <li>in Super B box</li> </ul>	
<b>880355</b> 100	<b>NIPPELDREHER</b> <b>›TB-7816‹</b> <ul style="list-style-type: none"> <li>ermöglicht ein <b>einfaches und schnelles Einspeichen</b></li> <li>mit Ersatzfeder</li> <li>auf Super B Eurolochkarte</li> </ul>	<b>NIPPLE DRIVER</b> <b>›TB-7816‹</b> <ul style="list-style-type: none"> <li>provides an <b>easy and fast wheel set manufacturing</b></li> <li>with replacement spring</li> <li>on Super B eurohole card</li> </ul>	
<b>880342</b> 200/25 set  <b>880341</b> 200/20  <b>880336</b> 400	<b>SPEICHENSCHLÜSSEL</b> Speichenschlüssel-Set auf cnSpoke Eurolochkarte, bestehend aus: <ul style="list-style-type: none"> <li>1 Sechskant 4,8 mm</li> <li>1 Vierkant 3,2 mm</li> <li>1 Schlitznippeldreher, mit Pin</li> </ul> <ul style="list-style-type: none"> <li><b>sehr hochwertige, präzise</b> Ausführung</li> <li>für verschiedene Nippelgrößen: 3,2 mm (14/15G), 3,4 mm (14/15G), 3,6 mm (13G), 3,9 mm (12G)</li> <li>auf cnSpoke Eurolochkarte</li> </ul> <ul style="list-style-type: none"> <li>für verschiedene Nippelgrößen: 3,2 mm (14/15G), 3,3 mm (14/15G), 3,4 mm (14/15G)</li> <li>einzelnen im Polybeutel</li> </ul>	<b>SPOKE WRENCH</b> spoke tool set on cnSpoke eurohole card, consisting of: <ul style="list-style-type: none"> <li>1 hex 4.8 mm</li> <li>1 square 3.2 mm</li> <li>1 slit wrench, with pin</li> </ul> <ul style="list-style-type: none"> <li><b>high quality, high precision</b> version</li> <li>for different spoke nipple sizes: 3.2 mm (14/15G), 3.4 mm (14/15G), 3.6 mm (13G), 3.9 mm (12G)</li> <li>on cnSpoke eurohole card</li> </ul> <ul style="list-style-type: none"> <li>for different spoke nipple sizes: 3.2 mm (14/15G), 3.3 mm (14/15G), 3.4 mm (14/15G)</li> <li>each in PE bag</li> </ul>	
<b>880331</b> 500/10	<ul style="list-style-type: none"> <li>aus Stahl</li> <li>für 6 verschiedene Nippelgrößen: 10G/11G/12G/13G/14G/15G</li> </ul>	<ul style="list-style-type: none"> <li>steel</li> <li>for 6 different spoke nipple sizes: 10G/11G/12G/13G/14G/15G</li> </ul>	

ART.-NR.	BESCHREIBUNG	DESCRIPTION	
<b>880021</b> 150/10	<b>SPEICHENLINEAL</b> • aus <b>Edelstahl</b> • für <b>präzises</b> Messen der Speichenlänge und <b>Nippelgröße</b> • in Einschiebhülle aus Kunststoff	<b>SPOKE RULER</b> • made of <b>stainless steel</b> • for <b>precise</b> measuring of the spoke length and <b>nipple size</b> • in slide-in cover made of plastic	<b>PROFI QUALITÄT</b> 
			UVP 10,90 €
<b>880340</b> 100	<b>GEWINDESICHERUNG</b> Verhindert ungewolltes Lockern der Nippel!  • in 15 ml Dosierflasche • für Selbstmontage und Nachrüstung • auch für andere Verschraubungen/ Gewinde verwendbar	<b>THREAD LOCK</b> Prevents nipples from unintentional slackening!  • in 15 ml dispenser bottle • for self installation and refitting • also usable for other threads/screws	
<b>289982</b>	Aufpreis für bereits werkseitig aufgetragene Gewindegewissung	upcharge for already applied lockseal by manufacturer	
<b>INFO</b>	Auf Wunsch verpacken wir <b>100 Speichen</b> oder <b>100 Speichen mit Nippeln</b> in Box (Art. 084874)	On request we'll pack <b>100 spokes</b> or <b>100 spokes with nipples</b> in box packaging (art. 084874)	
<b>084874</b> 100	Box für <b>100 Speichen mit Nippel</b>	box for <b>100 spokes with nipples</b>	
<b>084869</b> 40	Box für <b>500 Speichen mit Nippel</b>	box for <b>500 spokes with nipples</b>	

## NIPPEL

## NIPPLES

= 400 pro Dose, 18 Dosen pro Karton  
= 400 per can, 18 cans per box

OEM = 10.000 Stück, 500 im Polybeutel  
= 10.000 pieces, 500 in PE bag

ART.-NR.	BESCHREIBUNG		DESCRIPTION	
	<b>ALUMINIUMNIPPEL</b>  für <b>2,0 mm Speichen (14G)</b>		<b>ALUMINIUM NIPPLES</b>  for <b>2.0 mm Spokes (14G)</b>	
<b>280172</b>	14 mm, schwarz	400	14 mm, black	
<b>280166</b>	14 mm, rot	400	14 mm, red	
<b>280167</b>	14 mm, blau	400	14 mm, blue	
<b>280168</b>	14 mm, gold	400	14 mm, gold	
<b>280169</b>	14 mm, orange	350	14 mm, orange	
<b>280191</b>	14 mm, CNC AN, silber	350	14 mm, CNC AN, silver	
<b>289987</b>	Aufpreis für farbig oder schwarz eloxiert		upcharge for coloured or black anodizing	 art. 083139 (leere Dose) 



 = 400 pro Dose, 18 Dosen pro Karton  
= 400 per can, 18 cans per box

OEM = 10.000 Stück, 500 im Polybeutel  
= 10.000 pieces, 500 in PE bag

ART.-NR.	BESCHREIBUNG		DESCRIPTION
	<b>MESSINGNIPPEL</b> <b>für 2,0 mm Speichen (14G)</b>		<b>BRASS NIPPLES</b> <b>for 2.0 mm Spokes (14G)</b>
• <b>283369</b>	12 mm	OEM	12 mm
• <b>283295</b>	14 mm	OEM	14 mm
• <b>280165</b>	14 mm, schwarz	400	14 mm, black
<b>280101</b>	16 mm	400	16 mm
<b>280102</b>	20 mm	OEM	20 mm
<b>280100</b>	25 mm	OEM	25 mm
<b>280107</b>	13 mm (5,5 hex)	360	13 mm (5.5 hex)
<b>280110</b>	Hex 13 - 13 mm	360	Hex 13 - 13 mm
			 <p>2,0 mm</p> <p>12-25 mm</p> <p>14 mm / black</p> <p>13 mm / 5,5 hex</p> <p>Hex 13</p>
<b>280134</b>	für 2,3 mm Speichen (13G) 13 mm	OEM	for 2.3 mm Spokes (13G) 13 mm
	Vierkant, wie bei 2,0 mm (14G) Speichen. Dadurch müssen die <b>Laufmontagemaschinen nicht zwischen 13G und 14G umgestellt</b> werden.		square profile, like at 2.0 mm (14G) spokes. Therefore <b>wheel building robots do not need to be converted between 13G and 14G.</b>
<b>284598</b>	12 mm	OEM	12 mm
<b>280271</b>	12 mm, schwarz	OEM	12 mm, black
			 <p>2,3 mm</p> <p>2,3 MM SPOKES (13G)</p> <p>14G</p>
	<b>STAHLNIPPEL</b> <b>für 2,0 mm Speichen (14G)</b>		<b>STEEL NIPPLES</b> <b>for 2.0 mm Spokes (14G)</b>
• <b>284593</b>	12 mm, verzinkt	OEM	12 mm, zinc plated
• <b>280175</b>	12 mm, schwarz	OEM	12 mm, black
• <b>280121</b>	14 mm, verzinkt	OEM	14 mm, zinc plated
• <b>280197</b>	16 mm, verzinkt	OEM	16 mm, zinc plated
<b>280189</b>	16 mm, schwarz	400	16 mm, black
<b>289986</b>	Aufpreis für vernickelt		upcharge for nickel plated finish
<b>289985</b>	Aufpreis für schwarz		upcharge for black finish
	<b>BEILAGSCHEIBEN</b> optimal für empfindliche Felgen oder zum Aufbau von hochbelasteten Laufrädern		<b>SHIMS</b> ideal for sensitive rims or for building highly loaded wheels
<b>289902</b>	• Nirosa • 0,4 mm dick		• stainless steel • 0.4 mm thick
<b>289901</b> 2.000/500	• Aluminium • 0,6 mm dick		• aluminium • 0.6 mm thick
			 <p>7,5 mm</p> <p>4,3 mm</p>



## LINK TO PERFECTION

**KMC, der Weltmarktführer in Sachen Fahrradketten ist so innovativ wie kein zweiter Hersteller. Ketten von KMC stehen für minimiertes Gewicht, maximale Performance und höchste Lebensdauer – egal an welchem Rad sie sich drehen.**

**KMC, the world market leader in bicycle chains is more innovative than any other chain producer. All KMC chains stand for minimised weight, maximum performance and highest durability – no matter on which kind of bicycle they are used.**

### KOMPATIBEL

KMC Ketten gibt es für alle gängigen Schaltungsgattungen – sie sind kompatibel mit den Systemen aller großen Hersteller. Bereits die Produktnamen geben Auskunft: Die Ketten der X11-Serie beispielsweise passen zu allen 11-fach Systemen und sind darüberhinaus für unterschiedliche Einsatzzwecke geeignet. Ebenso die 12-fach Ketten der neusten Generation.

### COMPATIBLE

KMC chains are available for all common derailleur systems and they are compatible with the systems of all major manufacturers. The product names clarify this: The chains of the X11 series, for example, fit all 11-Speed systems. They are suitable for all cycling disciplines, as well as the 12 speed chains of the latest generation.

### HALTBAR

In vielen Praxistests wurde belegt, dass KMC Ketten länger halten als Ketten anderer Marken. Diese Aussage untermauert KMC durch die einzigartige Zufriedenheitsgarantie „Durability Warranty“ und der damit verbundenen Rückgabeoption, die das Vertrauen beweist, das KMC in ihre Produkte setzen.

### DURABLE

The many field tests KMC conducted, clearly show that KMC chains last much longer than comparable chains from other brands. KMC supports this statement with the unique satisfaction guarantee "Durability Warranty" and the associated return option, proving the trust KMC puts in their products.

### UNKOMPLIZIERT

Nahezu alle KMC Ketten werden mit einem Kettenschloss geliefert. Die Montage ist ganz einfach und eine sichere Verbindung stets gewährleistet. KMC Ketten haben keine vorgegebene Laufrichtung. Mit einem handelsüblichen Kettennietdrücker lässt sich jede Kette auf die richtige Länge kürzen. Für das Verschließen und Öffnen des Missing-Link empfehlen wir unsere Kettenzangen.

### EASY

Almost all boxed KMC chains come with a MissingLink. The installation is very simple and a secure lock always guaranteed. There is no given direction to mount the chain. With a standard chain de-riveter, each chain can be shortened to the correct length. For closing and opening the MissingLink we recommend our pliers.

## SMART PACKAGING

Die wertigen Kunststoffboxen setzen die KMC Ketten an jeder Verkaufswand optimal in Szene:

- Die Ketten werden in transparenter Verpackung sichtbar präsentiert
- Umweltfreundlich, da voll recyclebar oder wiederverwendbar
- Einheitliche, hochwertige Optik und Haptik
- Robust und nicht einreißend

The high-quality plastic boxes put the KMC chains in the limelight on every sales wall:

- The chains are visibly presented in transparent packaging
- Environmentally friendly because fully recyclable or reusable
- Uniform, high-quality look and feel
- Robust and not rousing







**NEW**  
eCargo 1



Art. 306198

## 100% SIND UNS ZU WENIG

eCargo1 – die Top-Schwerlastkette! Mit einer Zugfestigkeit von 1350 Nm liegt die eCargo1 bei 150 % des geforderten Standards. Sie ist perfekt für hohe Motorendrehmomente und schwere Lasten bei Cargobikes. Kombiniert mit den konstruktiv abgestimmten KMC-Ritzeln und -Kettenblättern ist sie optimal für den harten Alltagseinsatz – auch für unmotorisierte Lastenräder.

## 100% ARE NOT ENOUGH

eCargo1 – the top heavy-duty chain! With a tensile strength of 1350 Nm, the eCargo1 offers 150 % of the required standards. It is perfect for high motor torques and heavy loads on cargo bikes. Combined with the constructively coordinated KMC sprockets and chainrings, it is ideal for tough everyday use - even for non-motorized cargo bikes.



## Einzigartige Garantie

Mit diesem Gütesiegel garantiert KMC, dass eine KMC-Kette länger hält als vergleichbare Ketten anderer Marken. Diese Garantie erstreckt sich auf die Serien DLC, XSL, XEL, XL, X101 und E-Bike-Ketten. Sollten Sie einmal nicht zufrieden sein, regeln wir Reklamationen unkompliziert über: <https://www.kmcchain.de/Garantie>



## Unique guarantee

The life of a KMC chain with this quality warranty is guaranteed to last longer than other brands. This durability treatment includes all DLC, XSL, XEL, XL, X101 and e-bike chains. If you are not satisfied with the durability of your chain, fill out the form on <https://www.kmcchain.de/Garantie>



## E-Bike

Die E-Bike-Ketten wurden speziell für die Anforderungen von starken Mittelmotoren entwickelt. Ein optimiertes Bolzendesign sorgt für unübertroffene Langlebigkeit als wichtigstes Merkmal dieser Ketten.



## E-Bike

The e-bike chains are specially designed for use in combination with strong mid motors. Optimized pin power and unsurpassed durability are the key features of these e-Bike chains.



powered by



## 10.000 km +

Für E-Bikes mit Mittelmotor und Nabenschaltung wurden die Antriebsselemente perfekt aufeinander abgestimmt. Die Kombination der Kette e101 EPT mit einem 3 mm breiten Ritzel und Kettenblatt von KMC ermöglicht Laufleistungen von über 10.000 Kilometern. Garantiert!



## 10.000 km +

For e-bikes with strong mid motors and internal gear hubs KMC perfectly matched all drive train components. KMC's e101 EPT chain in combination with KMC's 3 mm wide sprockets and chainring ensure a lifespan of over 10,000 km – guaranteed!



powered by



## 3.500 km +

Die Kette e1 EPT in Verbindung mit unseren schmalen KMC-Kettenblättern und Ritzeln ermöglicht bei E-Bikes mit Nabenschaltung eine Lebensdauer von mindestens 3.500 km.



## 3.500 km +

KMC's e1 EPT chain in combination with KMC's narrow chainring and sprockets for e-bikes with internal gear hubs ensure a lifespan of over 3,500 km.



## EPT

KMC setzt neue Maßstäbe im Rostschutz. Die EcoProTeQ-Technologie schützt die Kette im Vergleich zu herkömmlichem Rostschutz zweimal so lange vor Rost. Die sehr glatte Oberfläche ist leiser, wirkt sich positiv auf die Laufeigenschaften aus und verleiht der Kette eine sehr hochwertige Optik.



## EPT

KMC's latest breakthrough in rust protection. EcoProTeQ treatment doubles the rust resistance compared to KMC's RB Anti-Rust treatment. Benefits of the smoother coating are less noise, optimum performance, maximum rust resistance and great look.



## Ti-N

Die goldfarbene KMC-Titan-Nitrid-Beschichtung sieht nicht nur fantastisch aus – die extrem glatte und harte Oberfläche verringert die Reibung und sorgt für geschmeidige Schaltvorgänge.



## Ti-N

KMC's golds-coloured special Titanium Nitride coating not only looks fantastic – the extremely smooth and hard surface reduces friction and ensures smooth shifting.



## Super leicht

Durchbrochene Innen- und Außenlaschen und Hohl-nieten sind der Weg, aus den Premium-Ketten das letzte Gramm herauszuholen.

Die KMC X11SL bringt bei 110 Gliedern gerade mal 225 Gramm auf die Waage. Damit ist sie die derzeit leichteste 11-fach-Kette.



## Super light

Open inner- and outer plates and hollow pins are the way to reduce the weight of the chain to the maximum.

KMC's X11SL weighs 225 grams per 110 links only, being the very lightest of all 11-speed chains.



## Extra leicht

Durchbrochene Innen- und Außenlaschen sparen Gewicht, ohne die Laufeigenschaften und die Langlebigkeit der Ketten der X-Serie EL zu beeinträchtigen.



## Extra light

Open inner- and outer plates save weight without compromising the smoothness and running qualities of the X EL Series.



## X-Bridge

Präzise gefaste Außenlaschen mit genau definierten Winkeln ermöglichen schnelle und exakte Schaltvorgänge.



## X-Bridge

Specially designed outer plate to enable fast, smooth and precise shifts.



ART.-NR.	BESCHREIBUNG	DESCRIPTION	
<b>12 SPEED</b>		<b>12 SPEED</b>	
	<p>›DLC12‹</p> <ul style="list-style-type: none"> <li>• 12-fach, 1/2" x 11/128"</li> <li>• 126 Glieder</li> <li>• <b>maximale Haltbarkeit</b> durch <b>verstärkte Vernietung, erhöhte Torsionsfestigkeit</b> und <b>minimalisierte Toleranzen</b></li> <li>• „<b>Diamond Like Coating</b>“ verlängert die Lebensdauer zusätzlich</li> <li>• kompatibel zu <b>Shimano / Sram MTB / Campagnolo</b></li> <li>• hochpräzise Fertigung garantiert <b>exzellentes Schaltverhalten</b></li> <li>• für <b>Elektrofahrräder</b> geeignet</li> <li>• nur <b>220 g</b> (110 Gl.)</li> <li>• mit MissingLink Verschlussglied</li> <li>• in KMC Einzelverpackung</li> </ul>	<p>›DLC12‹</p> <ul style="list-style-type: none"> <li>• 12 speed, 1/2" x 11/128"</li> <li>• 126 links</li> <li>• <b>maximum durability</b> due to <b>reinforced riveting, higher torsion stability</b> and <b>minimalized tolerances</b></li> <li>• „<b>Diamond Like Coating</b>“ additionally extends the durability</li> <li>• compatible with <b>Shimano / Sram MTB / Campagnolo</b></li> <li>• high-precision production guarantees <b>excellent shifting behavior</b></li> <li>• usable for <b>E-bikes</b></li> <li>• only <b>220 g</b> (110 li.)</li> <li>• with MissingLink</li> <li>• in KMC box</li> </ul>	 <p><b>220 g</b> <b>110 links</b></p>
<b>303500</b>	schwarz	black	
<b>303501</b>	schwarz - rot	black - red	
<b>303502</b>	schwarz - blau	black - blue	
<b>303503</b>	schwarz - grün	black - green	
<b>303504</b>	schwarz - orange	black - orange	
<b>303505</b>	schwarz - gelb	black - yellow	
<b>303506</b>	schwarz - pink	black - pink	
<b>NEW</b>			
<b>303507</b>	schwarz - celeste	black - celeste	
<b>NEW</b>	20		
			UVP 119,95 €
	<p>›e12‹</p> <ul style="list-style-type: none"> <li>• 12-fach, 1/2" x 11/128"</li> <li>• <b>130 Glieder, XL</b>, extra lang für <b>Elektrofahrräder</b></li> <li>• <b>hohe Haltbarkeit</b> durch <b>verstärkte Vernietung, erhöhte Torsionsfestigkeit</b> und <b>minimalisierte Toleranzen</b></li> <li>• kompatibel zu <b>Shimano / Sram MTB / Campagnolo</b></li> <li>• mit MissingLink Verschlussglied</li> <li>• in KMC Einzelverpackung</li> </ul>	<p>›e12‹</p> <ul style="list-style-type: none"> <li>• 12 speed, 1/2" x 11/128"</li> <li>• <b>130 links, XL</b>, extra long for <b>E-bikes</b></li> <li>• <b>high durability</b> through <b>reinforced riveting, higher torsion stability</b> and <b>minimalized tolerances</b></li> <li>• compatible with <b>Shimano / Sram MTB / Campagnolo</b></li> <li>• with MissingLink</li> <li>• in KMC box</li> </ul>	<p><b>XL 130 LINKS</b></p>
<b>306102</b>	›e12 EPT‹  mit „ <b>ECO ProTeQ</b> “ für eine <b>extrem rostresistente, glatte</b> und <b>umweltfreundliche</b> Oberfläche	›e12 EPT‹  with „ <b>ECO ProTeQ</b> “ for an <b>extremely rust resistant, smooth</b> and <b>environmentally friendly</b> cover	
			UVP 79,90 €
<b>306101</b>	›e12 Black Tech‹	›e12 Black Tech‹	
<b>NEW</b>	30		
			UVP 79,90 €



ART.-NR.	BESCHREIBUNG	DESCRIPTION	
	<p>›X12‹</p> <ul style="list-style-type: none"> <li>• 12-fach, 1/2" x 11/128"</li> <li>• 126 Glieder</li> <li>• kompatibel zu <b>Shimano / Sram / Campagnolo</b></li> <li>• max. Laufruhe</li> <li>• hochpräzise Fertigung garantiert <b>exzellentes Schaltverhalten</b></li> <li>• nur <b>234 g</b> (110 Gl.)</li> <li>• mit MissingLink Verschlussglied</li> <li>• in KMC Einzelverpackung</li> </ul>	<p>›X12‹</p> <ul style="list-style-type: none"> <li>• 12 speed, 1/2" x 11/128"</li> <li>• 126 links</li> <li>• max. smoothness</li> <li>• high-precision production guarantees <b>excellent shifting behavior</b></li> <li>• only <b>234 g</b> (110 li.)</li> <li>• with MissingLink</li> <li>• in KMC box</li> </ul>	
<b>303513</b>	<p>›X12 EPT‹</p> <p>mit "ECO ProTeQ" für eine <b>extrem rostresistente, glatte</b> und <b>umweltfreundliche</b> Oberfläche</p>	<p>›X12 EPT‹</p> <p>with "ECO ProTeQ" for an <b>extreme rust resistant, smooth</b> and <b>environmentally friendly</b> cover</p>	<p>UVP 54,90 €</p>
<b>303596</b>	<p>›X12 Aurora Blue‹</p> <p><b>neues Finish: Iridium-Beschichtung</b></p>	<p>›X12 Aurora Blue‹</p> <p><b>new finish: iridium coating</b></p>	<p>UVP 69,90 €</p>
<b>303510</b>	›X12 Ti-N Gold/Black‹	›X12 Ti-N Gold/Black‹	UVP 59,90 €
<b>303514</b>	›X12 Blacktech‹	›X12 Blacktech‹	UVP 59,90 €
<b>303511</b>	›X12 Ti-N Gold‹	›X12 Ti-N Gold‹	UVP 59,90 €
<b>303512</b>	›X12 Silver‹	›X12 Silver‹	UVP 49,90 €
<b>303515</b>	›X12 Silver/Black‹	›X12 Silver/Black‹	UVP 41,90 €

## 11 SPEED

## 11 SPEED

	<p>›DLC11‹</p> <ul style="list-style-type: none"> <li>• 11-fach, 1/2" x 11/128"</li> <li>• 118 Glieder</li> <li>• „<b>Diamond Like Coating</b>“ verlängert die Lebensdauer zusätzlich</li> <li>• kompatibel zu <b>Shimano / Sram / Campagnolo</b></li> <li>• nur <b>225 g</b> (110 Gl.)</li> <li>• mit <b>Hohlbolzen</b> und <b>ausgefrästen Innen- und Außenlaschen</b></li> <li>• hochpräzise Fertigung garantiert <b>exzellentes Schaltverhalten</b></li> <li>• mit MissingLink Verschlussglied</li> <li>• in KMC Einzelverpackung</li> </ul>	<p>›DLC11‹</p> <ul style="list-style-type: none"> <li>• 11 speed, 1/2" x 11/128"</li> <li>• 118 links</li> <li>• „<b>Diamond Like Coating</b>“ additionally extends the durability</li> <li>• compatible with <b>Shimano / Sram / Campagnolo</b></li> <li>• only <b>225 g</b> (110 li.)</li> <li>• with <b>hollow pins</b> and <b>milled out inner and outer plates</b></li> <li>• high-precision production guarantees <b>excellent shifting behavior</b></li> <li>• with MissingLink</li> <li>• in KMC box</li> </ul>	<p><b>225 g</b> <b>110 links</b></p> <p>„Probably the lightest 11 speed bicycle chain of the world!“</p>
<b>303520</b>	schwarz - schwarz	black - black	
<b>303525</b>	schwarz - rot	black - red	
<b>303521</b>	schwarz - blau	black - blue	
<b>303526</b>	schwarz - grün	black - green	
<b>303523</b>	schwarz - orange	black - orange	
<b>303527</b>	schwarz - gelb	black - yellow	
<b>303524</b>	schwarz - pink	black - pink	
<b>303522</b>	schwarz - türkis	black - celeste	

UVP 113,00 €

ART.-NR.	BESCHREIBUNG	DESCRIPTION	
	<p>›<b>X11SL</b>‹</p> <ul style="list-style-type: none"> <li>• 11-fach, 1/2" x 11/128"</li> <li>• <b>118 Glieder</b>, passend auch für extremere Übersetzungen</li> <li>• kompatibel zu <b>Shimano / Sram / Campagnolo</b></li> <li>• Shimano Cues 9-11-fach kompatibel</li> <li>• nur <b>225 g</b> (110 Gl.)</li> <li>• mit <b>Hohlbolzen</b> und <b>ausgefrästen Innen- und Außenlaschen</b></li> <li>• aus superleichtem und festem, hochlegiertem Stahl</li> <li>• mit MissingLink Verschlussglied</li> <li>• in KMC Einzelverpackung</li> </ul>	<p>›<b>X11SL</b>‹</p> <ul style="list-style-type: none"> <li>• 11 speed, 1/2" x 11/128"</li> <li>• <b>118 links</b>, also suitable for extreme transmission ratio</li> <li>• compatible with <b>Shimano / Sram / Campagnolo</b></li> <li>• compatible to Shimano Cues 9-11 speed</li> <li>• only <b>225 g</b> (110 li.)</li> <li>• with <b>hollow pins</b> and <b>milled out inner and outer plates</b></li> <li>• made of super light and firm, special alloy</li> <li>• with MissingLink</li> <li>• in KMC box</li> </ul>	      
303530	›X11SL Ti-N Gold/Black‹	›X11SL Ti-N Gold/Black‹ UVP 84,90 €	
303531	›X11SL Ti-N Gold‹	›X11SL Ti-N Gold‹ UVP 79,90 €	
303532 30	›X11SL Silver‹	›X11SL 15Silver‹ UVP 69,90 €	
	<p>›<b>X11EL</b>‹</p> <ul style="list-style-type: none"> <li>• 11-fach, 1/2" x 11/128"</li> <li>• 118 Glieder</li> <li>• kompatibel zu <b>Shimano / Sram / Campagnolo</b></li> <li>• Shimano Cues 9-11-fach kompatibel</li> <li>• nur <b>234 g</b> (110 Gl.)</li> <li>• <b>ausgefräste Innen- und Außenlaschen</b></li> <li>• mit MissingLink Verschlussglied</li> <li>• in KMC Einzelverpackung</li> </ul>	<p>›<b>X11EL</b>‹</p> <ul style="list-style-type: none"> <li>• 11 speed, 1/2" x 11/128"</li> <li>• 118 links</li> <li>• compatible with <b>Shimano / Sram / Campagnolo</b></li> <li>• compatible to Shimano Cues 9-11 speed</li> <li>• only <b>234 g</b> (110 li.)</li> <li>• <b>milled out inner and outer plates</b></li> <li>• with MissingLink</li> <li>• in KMC box</li> </ul>	     
303533	›X11EL Blacktech‹	›X11EL Blacktech‹ UVP 59,90 €	
303534	›X11EL Ti-N Gold‹	›X11EL Ti-N Gold‹ UVP 59,90 €	
303535 30	›X11EL Silver‹	›X11EL Silver‹ UVP 49,90 €	
	<p>›<b>e11</b>‹</p> <ul style="list-style-type: none"> <li>• 11-fach, 1/2" x 11/128"</li> <li>• <b>hohe Haltbarkeit</b> durch <b>verstärkte Vernietung</b>, <b>erhöhte Torsionsfestigkeit</b> und <b>minimalisierte Toleranzen</b></li> <li>• kompatibel zu <b>Shimano / Sram / Campagnolo</b></li> <li>• Shimano Cues 9-11-fach kompatibel</li> <li>• mit MissingLink Verschlussglied</li> <li>• in KMC Einzelverpackung</li> </ul>	<p>›<b>e11</b>‹</p> <ul style="list-style-type: none"> <li>• 11 speed, 1/2" x 11/128"</li> <li>• <b>high durability</b> through <b>reinforced riveting</b>, <b>higher torsion stability</b> and <b>minimalized tolerances</b></li> <li>• compatible with <b>Shimano / Sram / Campagnolo</b></li> <li>• compatible to Shimano Cues 9-11 speed</li> <li>• with MissingLink</li> <li>• in KMC box</li> </ul>	   <p><b>XXL 136 LINKS</b></p>  
306111	›e11 EPT‹	›e11 EPT‹ UVP 67,90 €	
306110 30	›e11 Silver‹ 122 Glieder	›e11 Silver‹ 122 links UVP 54,90 €	

ART.-NR.	BESCHREIBUNG	DESCRIPTION	
	<b>›X11‹</b> <ul style="list-style-type: none"> <li>• 11-fach, 1/2" x 11/128"</li> <li>• kompatibel zu <b>Shimano / Sram / Campagnolo</b></li> <li>• Shimano Cues 9-11-fach kompatibel</li> <li>• mit MissingLink Verschlussglied</li> <li>• in KMC Einzelverpackung</li> </ul>	<b>›X11‹</b> <ul style="list-style-type: none"> <li>• 11 speed, 1/2" x 11/128"</li> <li>• compatible with <b>Shimano / Sram / Campagnolo</b></li> <li>• compatible to Shimano Cues 9-11 speed</li> <li>• with MissingLink</li> <li>• in KMC box</li> </ul>	
<b>303536</b> 60	<b>›X11 EPT‹</b> <ul style="list-style-type: none"> <li>• 118 Glieder</li> <li>• mit <b>"ECO ProTeQ"</b> für eine <b>extrem rostresistente, glatte und umweltfreundliche</b> Oberfläche</li> </ul>	<b>›X11 EPT‹</b> <ul style="list-style-type: none"> <li>• 118 links</li> <li>• with <b>"ECO ProTeQ"</b> for an <b>extreme rust resistant, smooth and environmentally friendly</b> cover</li> </ul>	  
<b>303595</b> <b>NEW</b> 30	<b>›X11 Aurora Blue‹</b> <ul style="list-style-type: none"> <li>• 118 Glieder</li> <li>• <b>neues Finish: Iridium-Beschichtung</b></li> </ul>	<b>›X11 Aurora Blue‹</b> <ul style="list-style-type: none"> <li>• 118 links</li> <li>• <b>new finish: iridium coating</b></li> </ul>	
<b>303538</b>	<b>›X11 Silver/Black‹</b> 114 Glieder	<b>›X11 Silver/Black‹</b> 114 links	
<b>303542</b> 60	<b>›X11 Grey‹</b> 114 Glieder	<b>›X11 Grey‹</b> 114 links	

## 10 SPEED

## 10 SPEED

	<b>›X10SL‹</b> <ul style="list-style-type: none"> <li>• 10-fach, 1/2" x 11/128"</li> <li>• 114 Glieder</li> <li>• kompatibel zu <b>Shimano / Sram / Campagnolo</b></li> <li>• nur <b>244 g</b> (110 Gl.)</li> <li>• mit <b>Hohlbolzen</b> und <b>ausgefrästen Innen- und Außenlaschen</b></li> <li>• aus superleichtem und festem, hochlegiertem Stahl</li> <li>• mit MissingLink Verschlussglied</li> <li>• in KMC Einzelverpackung</li> </ul>	<b>›X10SL‹</b> <ul style="list-style-type: none"> <li>• 10 speed, 1/2" x 11/128"</li> <li>• 114 links</li> <li>• compatible with <b>Shimano / Sram / Campagnolo</b></li> <li>• only <b>244 g</b> (110 li.)</li> <li>• with <b>hollow pins</b> and <b>milled out inner and outer plates</b></li> <li>• made of super light and firm, special steel</li> <li>• with MissingLink</li> <li>• in KMC box</li> </ul>	    <b>244 g</b> <b>110 links</b>   
<b>303560</b>	<b>›X10SL Ti-N Gold‹</b>	<b>›X10SL Ti-N Gold‹</b>	
<b>303561</b> 30	<b>›X10SL Silver‹</b>	<b>›X10SL Silver‹</b>	
	<b>›X10EL‹</b> <ul style="list-style-type: none"> <li>• 10-fach, 1/2" x 11/128"</li> <li>• 114 Glieder</li> <li>• kompatibel zu <b>Shimano / Sram / Campagnolo</b></li> <li>• nur <b>250 g</b> (110 Gl.)</li> <li>• leicht durch <b>XL-Technologie</b></li> <li>• <b>ausgefräste Innen- und Außenlaschen</b></li> <li>• mit MissingLink Verschlussglied</li> <li>• in KMC Einzelverpackung</li> </ul>	<b>›X10EL‹</b> <ul style="list-style-type: none"> <li>• 10 speed, 1/2" x 11/128"</li> <li>• 114 links</li> <li>• compatible with <b>Shimano / Sram / Campagnolo</b></li> <li>• only <b>250 g</b> (110 li.)</li> <li>• light through <b>XL-technology</b></li> <li>• <b>milled out inner and outer plates</b></li> <li>• with MissingLink</li> <li>• in KMC box</li> </ul>	     
<b>303562</b>	<b>›X10EL Ti-N Gold‹</b>	<b>›X10EL Ti-N Gold‹</b>	
<b>303563</b> 30	<b>›X10EL Silver‹</b>	<b>›X10EL Silver‹</b>	



ART.-NR.	BESCHREIBUNG	DESCRIPTION	
	<p>›e10‹</p> <ul style="list-style-type: none"> <li>• 10-fach, 1/2" x 11/128"</li> <li>• <b>hohe Haltbarkeit</b> durch <b>verstärkte Bolzen</b>, erhöhte Torsionsfestigkeit und <b>minimalisierte Toleranzen</b></li> <li>• kompatibel zu <b>Shimano / Sram / Campagnolo</b></li> <li>• mit MissingLink Verschlussglied</li> <li>• in KMC Einzelverpackung</li> </ul>	<p>›e10‹</p> <ul style="list-style-type: none"> <li>• 10 speed, 1/2" x 11/128"</li> <li>• <b>high durability</b> through <b>reinforced pins</b>, higher torsion stability and <b>minimalized tolerances</b></li> <li>• compatible with <b>Shimano / Sram / Campagnolo</b></li> <li>• with MissingLink</li> <li>• in KMC box</li> </ul>	
<b>306115</b>	›e10 EPT‹	›e10 EPT‹	<p><b>XXL 136 LINKS</b></p>
<b>306114</b>	›e10 Silver‹	›e10 Silver‹	
30	122 Glieder	122 links	<p>UVP 64,90 €</p> <p>UVP 49,90 €</p>
	›X10‹	›X10‹	
<b>303564</b>	›X10 EPT‹	›X10 EPT‹	
<b>NEW</b> 30	mit "ECO ProTeQ" für eine <b>extrem rostresistente, glatte</b> und <b>umweltfreundliche</b> Oberfläche	<b>with "ECO ProTeQ"</b> for an <b>extreme rust resistant, smooth</b> and <b>environmentally friendly</b> cover	<p>UVP 47,90 €</p>
<b>303565</b>	›X10 Silver/Black‹	›X10 Silver/Black‹	<p>UVP 38,90 €</p>
<b>303572</b>	›X10 Grey‹	›X10 Grey‹	<p>UVP 38,90 €</p>
60			















ART.-NR.	BESCHREIBUNG	DESCRIPTION	
<b>9 SPEED</b>		<b>9 SPEED</b>	
	<b>›X9SL‹</b> <ul style="list-style-type: none"> <li>• 9-fach, 1/2" x 11/128"</li> <li>• 114 Glieder</li> <li>• kompatibel zu <b>Shimano / Sram / Campagnolo</b></li> <li>• 6,6 mm</li> <li>• nur <b>259 g</b> (110 Gl.)</li> <li>• mit <b>Hohlbolzen</b> und <b>ausgefrästen Innen- und Außenlaschen</b></li> <li>• aus superleichtem und festem, hochlegiertem Stahl</li> <li>• mit MissingLink Verschlussglied</li> <li>• in KMC Einzelverpackung</li> </ul>	<b>›X9SL‹</b> <ul style="list-style-type: none"> <li>• 9 speed, 1/2" x 11/128"</li> <li>• 114 links</li> <li>• compatible with <b>Shimano / Sram / Campagnolo</b></li> <li>• 6.6 mm</li> <li>• only <b>259 g</b> (110 li.)</li> <li>• with <b>hollow pins</b> and <b>milled out inner and outer plates</b></li> <li>• made of super light and firm, special alloy</li> <li>• with MissingLink</li> <li>• in KMC box</li> </ul>	<p>„Probably the lightest 9 speed bicycle chain in the world!“</p>
<b>303600</b>	›X9SL Ti-N Gold‹	›X9SL Ti-N Gold‹	UVP 54,90 €
<b>303601</b>	›X9SL Silver‹	›X9SL Silver‹	UVP 49,90 €
30			
	<b>›e9‹</b> <ul style="list-style-type: none"> <li>• 9-fach, 1/2" x 11/128"</li> <li>• kompatibel zu <b>Shimano / Sram / Campagnolo</b></li> <li>• <b>hohe Haltbarkeit</b> und <b>Zugkraft</b> durch <b>verstärkte Bolzen</b> (450 kg)</li> <li>• mit MissingLink Verschlussglied</li> <li>• in KMC Einzelverpackung</li> </ul>	<b>›e9‹</b> <ul style="list-style-type: none"> <li>• 9 speed, 1/2" x 11/128"</li> <li>• compatible with <b>Shimano / Sram / Campagnolo</b></li> <li>• <b>high durability</b> and <b>traction</b> through <b>reinforced pins</b> (450 kg)</li> <li>• with MissingLink</li> <li>• in KMC box</li> </ul>	<p><b>XXL 136 LINKS</b></p>
<b>306118</b>	›e9 EPT‹	›e9 EPT‹	UVP 59,90 €
	<ul style="list-style-type: none"> <li>• mit <b>"ECO ProTeQ"</b> für eine <b>extrem rostresistente, glatte und umweltfreundliche</b> Oberfläche</li> <li>• <b>136 Glieder:</b> extra lang für <b>Elektrofahrräder</b></li> </ul>	<ul style="list-style-type: none"> <li>• with <b>"ECO ProTeQ"</b> for an <b>extreme rust resistant, smooth and environmentally friendly</b> cover</li> <li>• <b>136 links:</b> extra long for <b>E-Bikes</b></li> </ul>	
<b>306136</b>	›e9 Silver‹	›e9 Silver‹	UVP 44,90 €
30	<b>122 Glieder</b>	<b>122 links</b>	
	<b>›X9‹</b> <ul style="list-style-type: none"> <li>• 9-fach, 1/2" x 11/128"</li> <li>• 114 Glieder</li> <li>• kompatibel zu <b>Shimano / Sram / Campagnolo</b></li> <li>• mit MissingLink Verschlussglied</li> <li>• in KMC Einzelverpackung</li> </ul>	<b>›X9‹</b> <ul style="list-style-type: none"> <li>• 9 speed, 1/2" x 11/128"</li> <li>• 114 links</li> <li>• compatible with <b>Shimano / Sram / Campagnolo</b></li> <li>• with MissingLink</li> <li>• in KMC box</li> </ul>	
<b>303605</b>	›X9 EPT‹	›X9 EPT‹	UVP 36,90 €
60	mit <b>"ECO ProTeQ"</b> für eine <b>extrem rostresistente, glatte und umweltfreundliche</b> Oberfläche	with <b>"ECO ProTeQ"</b> for an <b>extreme rust resistant, smooth and environmentally friendly</b> cover	
<b>303603</b>	›X9 Ti-N Gold‹	›X9 Ti-N Gold‹	UVP 47,90 €
<b>NEW</b>	30		
<b>303604</b>	›X9 Silver‹	›X9 Silver‹	UVP 32,90 €
<b>NEW</b>			
<b>303606</b>	›X9 Silver/Grey‹	›X9 Silver/Grey‹	UVP 26,90 €
<b>303612</b>	›X9 Grey‹	›X9 Grey‹	UVP 19,90 €
60			

ART.-NR.	BESCHREIBUNG	DESCRIPTION	
<b>8 SPEED</b>		<b>8 SPEED</b>	
<b>306128</b> 30 <b>NEW</b>	<b>›e8 EPT‹</b> <ul style="list-style-type: none"> <li>• 8-fach, 1/2" x 3/32"</li> <li>• 122 Glieder</li> <li>• mit "ECO ProTeQ" für eine <b>extrem rostresistente, glatte und umweltfreundliche</b> Oberfläche</li> <li>• <b>hohe Haltbarkeit</b> durch <b>verstärkte Vernietung, erhöhte Torsionsfestigkeit und minimalisierte Toleranzen</b></li> <li>• mit MissingLink Verschlussglied</li> <li>• in KMC Einzelverpackung</li> </ul>	<b>›e8 EPT‹</b> <ul style="list-style-type: none"> <li>• 8 speed, 1/2" x 3/32"</li> <li>• 122 links</li> <li>• with "ECO ProTeQ" for an <b>extreme rust resistant, smooth and environmentally friendly</b> cover</li> <li>• <b>high durability</b> through <b>reinforced riveting, higher torsion stability and minimalized tolerances</b></li> <li>• with MissingLink</li> <li>• in KMC box</li> </ul>	
<b>303620</b>	<b>›X8‹</b> <ul style="list-style-type: none"> <li>• <b>21-24</b> Gang</li> <li>• 8-fach, 1/2" x 3/32"</li> <li>• 114 Glieder</li> <li>• 7,3 mm</li> <li>• mit MissingLink Verschlussglied</li> <li>• in KMC Einzelverpackung</li> </ul>	<b>›X8‹</b> <ul style="list-style-type: none"> <li>• <b>21-24</b> speed</li> <li>• 8 speed, 1/2" x 3/32"</li> <li>• 114 links</li> <li>• 7.3 mm</li> <li>• with MissingLink</li> <li>• in KMC box</li> </ul>	
<b>303622</b> 60	›X8 Silver/Grey‹	›X8 Silver/Grey‹	UVP 19,90 €
<b>303700</b>	<b>›Z8‹</b> <ul style="list-style-type: none"> <li>• <b>18-24</b> Gang</li> <li>• 8-fach, 1/2" x 3/32"</li> <li>• 114 Glieder</li> <li>• 7,3 mm</li> <li>• mit MissingLink Verschlussglied</li> <li>• in KMC Einzelverpackung</li> </ul>	<b>›Z8‹</b> <ul style="list-style-type: none"> <li>• <b>18-24</b> speed</li> <li>• 8 speed, 1/2" x 3/32"</li> <li>• 114 links</li> <li>• 7.3 mm</li> <li>• with MissingLink</li> <li>• in KMC box</li> </ul>	
<b>303701</b>	›Z8 Silver/Grey‹	›Z8 Silver/Grey‹	UVP 13,90 €
<b>303705</b> 60	›Z8 Grey‹	›Z8 Grey‹	UVP 11,90 €
<b>7 SPEED</b>		<b>7 SPEED</b>	
<b>303710</b> 60	<b>›Z7‹</b> <ul style="list-style-type: none"> <li>• <b>18-21</b> Gang</li> <li>• 7-fach, 1/2" x 3/32"</li> <li>• 114 Glieder</li> <li>• 7,3 mm</li> <li>• grau/braun</li> <li>• mit MissingLink Verschlussglied</li> <li>• im KMC Einzelkarton</li> </ul>	<b>›Z7‹</b> <ul style="list-style-type: none"> <li>• <b>18-21</b> speed</li> <li>• 7 speed, 1/2" x 3/32"</li> <li>• 114 links</li> <li>• 7.3 mm</li> <li>• grey/brown</li> <li>• with MissingLink</li> <li>• in KMC box</li> </ul>	
			UVP 9,90 €
<b>6 SPEED</b>		<b>6 SPEED</b>	
<b>303711</b> 60	<b>›Z6‹</b> <ul style="list-style-type: none"> <li>• <b>18</b> Gang</li> <li>• 6-fach, 1/2" x 3/32"</li> <li>• 114 Glieder</li> <li>• 7,3 mm</li> <li>• grau</li> <li>• mit MissingLink Verschlussglied</li> <li>• im KMC Einzelkarton</li> </ul>	<b>›Z6‹</b> <ul style="list-style-type: none"> <li>• <b>18</b> speed</li> <li>• 6 speed, 1/2" x 3/32"</li> <li>• 114 links</li> <li>• 7.3 mm</li> <li>• grey</li> <li>• with MissingLink</li> <li>• in KMC box</li> </ul>	
			UVP 8,90 €



ART.-NR.	BESCHREIBUNG	DESCRIPTION	
<b>1 SPEED</b>		<b>1/2" x 3/32"</b>	<b>1 SPEED</b>
	<p>›e1 EPT‹</p> <ul style="list-style-type: none"> <li>• 1-fach, 1/2" x 3/32"</li> <li>• <b>Reißfestigkeit 1.000 kg</b></li> <li>• nur <b>296 g</b></li> <li>• besonders geeignet für <b>hochwertige Nabenschaltungssysteme</b> wie <b>Rohloff</b></li> <li>• mit <b>"ECO ProTeQ"</b> für eine <b>extrem rostresistente, glatte</b> und <b>umweltfreundliche</b> Oberfläche</li> <li>• sehr <b>verschleißarm</b> durch <b>XX-SP-Bolzen</b></li> <li>• mit <b>großen Innenlaschen</b> um das Herabfallen zu verhindern</li> <li>• mit MissingLink Verschlussglied</li> <li>• in KMC Einzelverpackung</li> </ul>	<p>›e1 EPT‹</p> <ul style="list-style-type: none"> <li>• 1 speed, 1/2" x 3/32"</li> <li>• <b>tensile strength 1,000 kg</b></li> <li>• only <b>296 g</b></li> <li>• especially suitable for <b>high quality gear hubs</b> like <b>Rohloff</b></li> <li>• with <b>"ECO ProTeQ"</b> for an <b>extreme rust resistant, smooth</b> and <b>environmentally friendly</b> cover</li> <li>• <b>low wear</b> by <b>XX-SP</b> bolt</li> <li>• no falling down due to <b>higher inner plates</b></li> <li>• with MissingLink</li> <li>• in KMC box</li> </ul>	<p><b>3,500km+</b></p> <p>in Kombination mit KMC-Ritzel und -Kettenblatt</p> <p>in combination with KMC sprocket and chainring</p>
<b>306122</b>	110 Glieder	110 links	UVP 39,90 €
<b>306123</b>	130 Glieder	130 links	UVP 44,90 €
30			
<b>XXL 130 LINKS</b>			
	<p>›Z1eHX Narrow‹</p> <ul style="list-style-type: none"> <li>• 1-fach, 1/2" x 3/32"</li> <li>• 8 mm</li> <li>• kein Herabfallen durch <b>breitere Innenlaschen</b> ("StopDrop")</li> <li>• <b>höchste Lebensdauer</b> durch <b>HX-Stretch Proof-Behandlung</b></li> <li>• <b>verstärkte Bolzen</b></li> <li>• <b>abgeschrägte Innenlaschen</b> für <b>ruhigeren Lauf</b> und <b>mehr Toleranz</b> der Kettenlinie</li> <li>• <b>Reißfestigkeit 1.050 kg</b></li> <li>• mit MissingLink Verschlussglied</li> <li>• in KMC Einzelverpackung</li> </ul>	<p>›Z1eHX Narrow‹</p> <ul style="list-style-type: none"> <li>• 1 speed, 1/2" x 3/32"</li> <li>• 8 mm</li> <li>• no falling down due to <b>higher inner plates</b> ("StopDrop")</li> <li>• <b>highest durability</b> by <b>HX stretch proof treatment</b></li> <li>• <b>mushroomed pins</b></li> <li>• <b>chamfered inner plates</b> for <b>smoother running</b> and <b>more allowance</b> for the chain line</li> <li>• <b>tensile strength 1,050 kg</b></li> <li>• with MissingLink</li> <li>• in KMC box</li> </ul>	<p><b>XXL 128 LINKS</b></p>
<b>306134</b>	›Z1eHX Narrow EPT‹	›Z1eHX Narrow EPT‹	UVP 26,90 €
	<ul style="list-style-type: none"> <li>• mit <b>"ECO ProTeQ"</b> für eine <b>extrem rostresistente, glatte</b> und <b>umweltfreundliche</b> Oberfläche</li> <li>• <b>128 Glieder:</b> extra lang für <b>Elektrofahrräder</b></li> </ul>	<ul style="list-style-type: none"> <li>• with <b>"ECO ProTeQ"</b> for an <b>extreme rust resistant, smooth</b> and <b>environmentally friendly</b> cover</li> <li>• <b>128 links:</b> extra long for <b>E-bikes</b></li> </ul>	
<b>306131</b>	›Z1eHX Narrow‹	›Z1eHX Narrow‹	UVP 21,90 €
60	112 Glieder	112 links	
<b>303720</b>	›Z1Narrow EPT‹	›Z1Narrow EPT‹	UVP 21,90 €
<b>NEW</b>	<ul style="list-style-type: none"> <li>• 1-fach, 1/2" x 3/32"</li> <li>• 8 mm</li> <li>• 112 Glieder</li> <li>• mit <b>"ECO ProTeQ"</b> für eine <b>extrem rostresistente, glatte</b> und <b>umweltfreundliche</b> Oberfläche</li> <li>• <b>verstärkte Bolzen</b></li> <li>• <b>abgeschrägte Innenlaschen</b> für <b>ruhigeren Lauf</b> und <b>mehr Toleranz</b> der Kettenlinie</li> <li>• mit MissingLink Verschlussglied</li> <li>• in KMC Einzelverpackung</li> </ul>	<ul style="list-style-type: none"> <li>• 1 speed, 1/2" x 3/32"</li> <li>• 8 mm</li> <li>• 112 links</li> <li>• with <b>"ECO ProTeQ"</b> for an <b>extreme rust resistant, smooth</b> and <b>environmentally friendly</b> cover</li> <li>• <b>mushroomed pins</b></li> <li>• <b>chamfered inner plates</b> for <b>smoother running</b> and <b>more allowance</b> for the chain line</li> <li>• with MissingLink</li> <li>• in KMC box</li> </ul>	
60			



ART.-NR.	BESCHREIBUNG	DESCRIPTION	
<b>1 SPEED</b>		<b>1/2" x 1/8"</b>	<b>1 SPEED</b>
<b>306125</b> 30	<b>&gt;e101 EPT&lt;</b> <ul style="list-style-type: none"> <li>• 1-fach, 1/2" x 1/8"</li> <li>• 112 Glieder</li> <li>• mit "ECO ProTeQ" für eine <b>extrem rostresistente, glatte und umweltfreundliche</b> Oberfläche</li> <li>• bei Nutzung mit KMC 1/8" Kettenblatt und KMC Ritzel (Art. 350075-8, 350094-6) <b>enorm lange Haltbarkeit</b> bis deutlich <b>über 10.000 km garantiert</b></li> <li>• Kettenblatt und Kette bei vielen Fahrrädern einfach nachzurüsten</li> <li>• mit MissingLink Verschlussglied</li> <li>• in KMC Einzelverpackung</li> </ul>	<b>&gt;e101 EPT&lt;</b> <ul style="list-style-type: none"> <li>• 1 speed, 1/2" x 1/8"</li> <li>• 112 links</li> <li>• with "ECO ProTeQ" for an <b>extreme rust resistant, smooth and environmentally friendly</b> cover</li> <li>• when using with KMC 1/8" chainring and KMC sprocket (art. 350075-8, 350094-6) <b>enormously longlasting running performance</b> significantly <b>over 10,000 km</b></li> <li>• chainring and chain easily retrofitted at lots of bicycles</li> <li>• with MissingLink</li> <li>• in KMC box</li> </ul>	  <div style="border: 1px solid green; padding: 5px; display: inline-block; margin: 10px;"> <b>10,000km+</b>  <small>powered by KMC</small> </div>  
		UVP 73,90 €	
<b>Lebensdauer des Antriebs bei E-Bikes mit Mittelmotor      Drive durability of e-bikes with mid-mounted engine</b>			
e101 EPT / KMC Ritzel breit		10.000 km +	powered by 
e1 EPT / KMC Ritzel schmal		3.500 km +	powered by 
Standard			
<b>306127</b> 60	<b>&gt;Z1 eHX WIDE&lt;</b> <ul style="list-style-type: none"> <li>• 1-fach, 1/2" x 1/8"</li> <li>• 112 Glieder</li> <li>• 9,2 mm</li> <li>• <b>hohe Haltbarkeit</b> durch <b>verstärkte Bolzen und Kettenglieder</b></li> <li>• kein Herabfallen durch <b>breitere Innenlaschen</b> ("StopDrop")</li> <li>• gehärtete Bolzen</li> <li>• <b>abgeschrägte Innenlaschen</b> für <b>ruhigeren Lauf und mehr Toleranz</b> der Kettenlinie</li> <li>• silber</li> <li>• mit MissingLink Verschlussglied</li> <li>• in KMC Einzelverpackung</li> </ul>	<b>&gt;Z1 eHX WIDE&lt;</b> <ul style="list-style-type: none"> <li>• 1 speed, 1/2" x 1/8"</li> <li>• 112 links</li> <li>• 9.2 mm</li> <li>• <b>high durability</b> through <b>reinforced pins and chain links</b></li> <li>• no falling down due to <b>higher inner plates</b> ("StopDrop")</li> <li>• hardened bolts</li> <li>• <b>chamfered inner plates</b> for <b>smoother running and more allowance</b> for the chain line</li> <li>• silver</li> <li>• with MissingLink</li> <li>• in KMC box</li> </ul>	  
		UVP 21,90 €	
	<b>&gt;Z1 WIDE EPT&lt;</b> <ul style="list-style-type: none"> <li>• 1-fach, 1/2" x 1/8"</li> <li>• 8,6 mm</li> <li>• mit "ECO ProTeQ" für eine <b>extrem rostresistente, glatte und umweltfreundliche</b> Oberfläche</li> <li>• kein Herabfallen durch <b>breitere Innenlaschen</b> ("StopDrop")</li> <li>• gehärtete Bolzen</li> <li>• <b>abgeschrägte Innenlaschen</b> für <b>ruhigeren Lauf und mehr Toleranz</b> der Kettenlinie</li> <li>• mit MissingLink Verschlussglied</li> <li>• in KMC Einzelverpackung</li> </ul>	<b>&gt;Z1 WIDE EPT&lt;</b> <ul style="list-style-type: none"> <li>• 1 speed, 1/2" x 1/8"</li> <li>• 8.6 mm</li> <li>• with "ECO ProTeQ" for an <b>extreme rust resistant, smooth and environmentally friendly</b> cover</li> <li>• no falling down due to <b>higher inner plates</b> ("StopDrop")</li> <li>• hardened bolts</li> <li>• <b>chamfered inner plates</b> for <b>smoother running and more allowance</b> for the chain line</li> <li>• with MissingLink</li> <li>• in KMC box</li> </ul>	  
<b>303731</b>	<b>128 Glieder:</b> extra lang für <b>Elektrofahrräder</b>	<b>128 links:</b> extra long for <b>E-bikes</b>	<div style="border: 1px solid blue; padding: 2px; display: inline-block; margin: 5px;"> <b>XXL 128 LINKS</b> </div> 
		UVP 21,90 €	
<b>303730</b> 60	112 Glieder	112 links	UVP 19,90 €

ART.-NR.	BESCHREIBUNG	DESCRIPTION	
	<p>›S1‹</p> <ul style="list-style-type: none"> <li>• 1-fach, 1/2" x 1/8"</li> <li>• 112 Glieder</li> <li>• 8,6 mm</li> <li>• hülsenlos</li> <li>• geräuscharm</li> <li>• mit Verschlussglied</li> <li>• in KMC Einzelverpackung</li> </ul>	<p>›S1‹</p> <ul style="list-style-type: none"> <li>• 1 speed, 1/2" x 1/8"</li> <li>• 112 links</li> <li>• 8.6 mm</li> <li>• without bushes</li> <li>• low running noise</li> <li>• with connecting link</li> <li>• in KMC box</li> </ul>	
<b>303740</b>	›S1 Wide RB‹ mit <b>Anti-Rost</b> -Beschichtung <b>„Rust Buster“</b>	›S1 Wide RB‹ with <b>anti-rust coating „Rust Buster“</b>	
<b>303742</b> 60	›S1 Wide Brown‹	›S1 Wide Brown‹	
<b>303795</b> 60	›K1 WIDE SILVER/BLACK‹	›K1 WIDE SILVER/BLACK‹	
	<ul style="list-style-type: none"> <li>• 1-fach, 1/2" x 1/8"</li> <li>• 110 Glieder</li> <li>• 9,4 mm</li> <li>• für BMX, Freestyle, Bahn, ...</li> <li>• kein Herabfallen durch <b>breitere Innenlaschen</b> ("StopDrop")</li> <li>• mit MissingLink Verschlussglied</li> <li>• Reißfestigkeit 1.300 kg</li> <li>• in KMC Einzelverpackung</li> </ul>	<ul style="list-style-type: none"> <li>• 1 speed, 1/2" x 1/8"</li> <li>• 110 links</li> <li>• 9.4 mm</li> <li>• for BMX, freestyle, track, ...</li> <li>• no falling down due to <b>higher inner plates</b> ("StopDrop")</li> <li>• with MissingLink</li> <li>• tensile strength 1,300 kg</li> <li>• in KMC box</li> </ul>	
<b>303789</b> 60	<p><b>OFFSET/HALBGLIEDKETTE</b></p> <p>›HL1 WIDE SILVER‹</p> <p>Besonders geeignet für Rahmen und Antriebssysteme, bei denen die Ketten- spannung nicht verändert werden kann und die Kette <b>genau abgelängt</b> werden muss.</p> <ul style="list-style-type: none"> <li>• 1-fach, 1/2" x 1/8"</li> <li>• für Trial, BMX, Bahn, ...</li> <li>• 100 Glieder</li> <li>• 9,4 mm</li> <li>• <b>Reißfestigkeit 1050 kg</b></li> <li>• in KMC Einzelverpackung</li> </ul>	<p><b>OFFSET/HALFLINK CHAIN</b></p> <p>›HL1 WIDE SILVER‹</p> <p>In particular suitable for all frames and drive systems w/o possibility to change the chain tension and where the chain has to be cut to <b>length exactly</b>.</p> <ul style="list-style-type: none"> <li>• 1 speed, 1/2" x 1/8"</li> <li>• for trial, BMX, track, ...</li> <li>• 100 links</li> <li>• 9.4 mm</li> <li>• <b>tensile strength 1050 kg</b></li> <li>• in KMC box</li> </ul>	



ART.-NR.	BESCHREIBUNG	DESCRIPTION
----------	--------------	-------------

## FÜR WERKSTÄTTEN UND MONTAGEN FOR WORKSHOPS AND FACTORIES

<p><b>309900</b></p>	<p><b>50 METER - ROLLE UND DISPLAY</b></p> <p>Für Fahrradhändler mit Werkstattbereich bietet KMC die beliebtesten Kettenmodelle, von der 1-fach-Nabenschaltungs- bis zur 12-fach-Kette, auf Werkstatt-Rollen von je 50 Metern an. Wegen der großen Anzahl an unterschiedlichen Kettenlängen, gerade für E-Bikes, fallen bei schon abgelängten Ketten viele Abfallstücke an. Die 50 Meter Rollen bieten <b>mehr Flexibilität, weniger Abfall und niedrigere Kosten</b>, da die Kette auf die <b>gewünschte Länge</b> gekürzt werden kann. Natürlich liefert KMC die richtigen <b>Verschlussglieder</b> für die sichere und einfache Montage mit.</p> <p><b>KETTENROLLENHALTER</b></p> <ul style="list-style-type: none"> <li>• stabiles Stahlgestell</li> <li>• mit Magnethalter für das Kettenende</li> <li>• mit Halter für 40er Box Verschlußglieder</li> </ul> <p>• für <b>3 x 50 Meter</b> Kettenrollen • <b>fahrbar</b> und höhenverstellbar</p>	<p><b>50 METER REEL AND DISPLAY</b></p> <p>For professional dealers with workshop, KMC now offers some chain models on workshop reels. The key models, from single speed up to 12 speed chains, are available packed on 50 meter reels. Due to the large variety of chain lengths, especially for e-bikes, ready cut to length chains will produce a lot of rejects: The 50 meter reel offers the advantage of <b>flexibility</b>, you can shorten to the <b>desired length</b> with <b>less waste and lower cost</b>. Of course, KMC will include the right <b>connecting links</b> for secure and easy assembly.</p> <p><b>CHAIN REEL HOLDER</b></p> <ul style="list-style-type: none"> <li>• stable steel rack</li> <li>• magnetic bracket for the end of chains</li> <li>• with holder for box with 40 connecting links</li> </ul> <p>• for <b>3 x 50 meter</b> chain reels • <b>mobile</b> and height adjustable</p> <p>UVP 490,00 €</p>
<p><b>309901</b></p>	<p>• für <b>1 x 50 Meter</b> Kettenrolle • für <b>Wandmontage</b> oder auf (Tisch-)Standfuß Art. 309902</p>	<p>• for <b>1 x 50 meter</b> chain reel • for <b>mounting on wall</b> or with (table) foot art. 309902</p> <p>UVP 65,90 €</p>
<p><b>309902</b> 1</p>	<p><b>(Tisch-)Standfuß</b> für Art. 309901</p>	<p><b>(table) foot</b> for art. 309901</p> <p>UVP 52,90 €</p>



Art. 309900



Art. 309901

















Art. 309902

	KETTEN	CHAINS
<p><b>303517</b> 1 roll</p>	<p>›<b>X12 SILVER/BLACK</b>‹ inkl. 40 MissingLinks 12NR EPT</p>	<p>›<b>X12 SILVER/BLACK</b>‹ inkl. 40 MissingLinks 12NR EPT</p>
<p><b>306113</b></p>	<p>›<b>e11 EPT</b>‹ inkl. 40 MissingLinks 11NR EPT</p>	<p>›<b>e11 EPT</b>‹ inkl. 40 MissingLinks 11NR EPT</p>
<p><b>303541</b></p>	<p>›<b>X11 SILVER/BLACK</b>‹ inkl. 40 MissingLinks 11R EPT</p>	<p>›<b>X11 SILVER/BLACK</b>‹ inkl. 40 MissingLinks 11R EPT</p>
<p><b>303598</b> 1 roll</p>	<p>›<b>X11 GREY</b>‹ inkl. 40 MissingLinks 11R EPT</p>	<p>›<b>X11 GREY</b>‹ inkl. 40 MissingLinks 11R EPT</p>
<p><b>306116</b></p>	<p>›<b>e10 EPT</b>‹ inkl. 40 MissingLinks 10NR EPT</p>	<p>›<b>e10 EPT</b>‹ inkl. 40 MissingLinks 10NR EPT</p>
<p><b>303571</b></p>	<p>›<b>X10 SILVER/BLACK</b>‹ inkl. 40 MissingLinks 10R EPT, wiederverwendbar</p>	<p>›<b>X10 SILVER/BLACK</b>‹ inkl. 40 MissingLinks 10R EPT, reusable</p>
<p><b>303574</b> 1 roll</p>	<p>›<b>X10 GREY</b>‹ inkl. 40 MissingLinks 10R EPT, wiederverwendbar</p>	<p>›<b>X10 GREY</b>‹ inkl. 40 MissingLinks 10R EPT, reusable</p>













**50 meter**  
incl. MissingLinks



























ART.-NR.	BESCHREIBUNG	DESCRIPTION	50 meter incl. MissingLinks 
FÜR WERKSTÄTTEN			FOR WORKSHOPS
306119	<b>›e9 EPT‹</b> inkl. 40 MissingLinks 9NR EPT	<b>›e9 EPT‹</b> incl. 40 MissingLinks 9NR EPT	
303611	<b>›X9 SILVER/GREY‹</b> inkl. 40 MissingLinks 9R EPT, wiederverwendbar	<b>›X9 SILVER/GREY‹</b> incl. 40 MissingLinks 9R EPT, reusable	
303614	<b>›X9 GREY‹</b> 1 roll inkl. 40 MissingLinks 9R EPT, wiederverwendbar	<b>›X9 GREY‹</b> incl. 40 MissingLinks 9R EPT, reusable	
303624	<b>›X8 SILVER/GREY‹</b> inkl. 40 MissingLinks 7/8R EPT, wiederverwendbar	<b>›X8 SILVER/GREY‹</b> incl. 40 MissingLinks 7/8R EPT, reusable	
303704	<b>›Z8 GREY‹</b> 1 roll inkl. 40 MissingLinks 7/8R EPT, wiederverwendbar	<b>›Z8 GREY‹</b> incl. 40 MissingLinks 7/8R EPT, reusable	
306124	<b>›e1 EPT‹</b> inkl. 40 MissingLinks e1NR EPT	<b>›e1 EPT‹</b> incl. 40 MissingLinks e1NR EPT	<b>1/2 X 3/32", NARROW</b> 
306135	<b>›Z1eHX NARROW EPT‹</b> inkl. 40 MissingLinks Z1eHX Narrow NR EPT	<b>›Z1eHX NARROW EPT‹</b> incl. 40 MissingLinks Z1eHX Narrow NR EPT	
306132	<b>›Z1eHX NARROW‹</b> 1 roll inkl. 40 MissingLinks Z1eHX Narrow NR	<b>›Z1eHX NARROW‹</b> incl. 40 MissingLinks Z1eHX Narrow NR	
<b>NEW</b> 306126	<b>›e101 EPT‹</b> inkl. 40 MissingLinks 101NR EPT	<b>›e101 EPT‹</b> incl. 40 MissingLinks 101NR EPT	<b>1/2 X 1/8", WIDE</b> 
<b>NEW</b> 306198	<b>›eCARGO1‹</b> <ul style="list-style-type: none"> <li>Schwerlastkette mit <b>1.350 Nm Zugfestigkeit</b> (=150% des geforderten Standards)</li> <li>inkl. 40 MissingLinks eCargo NR EPT</li> </ul>	<b>›eCARGO1‹</b> <ul style="list-style-type: none"> <li>heavy-duty chain with <b>1,350 Nm tensile strength</b> (=150% from standard)</li> <li>incl. 40 MissingLinks eCargo NR EPT</li> </ul>	
306130	<b>›Z1eHX WIDE EPT‹</b> inkl. 40 MissingLinks Z1eHX Wide NR EPT	<b>›Z1eHX WIDE EPT‹</b> incl. 40 MissingLinks Z1eHX Wide NR EPT	
303741	<b>›S1 WIDE RB‹</b> inkl. 40 Verschlussglieder Snap-On Wide EPT	<b>›S1 WIDE RB‹</b> incl. 40 connecting links Snap-On Wide EPT	
303744	<b>›S1 WIDE BROWN‹</b> 1 roll inkl. 40 Verschlussglieder Snap-On Wide EPT	<b>›S1 WIDE BROWN‹</b> incl. 40 connecting links Snap-On Wide EPT	



ART.-NR.	BESCHREIBUNG	DESCRIPTION	 <b>25/50 pcs (in PE bag)</b> or <b>150 meter (roll)</b> 
FÜR WERKSTÄTTEN UND MONTAGEN		FOR WORKSHOPS AND FACTORIES	
<b>303516</b> 1 box	<b>›X12 SILVER/BLACK‹</b> • 126 Glieder • inkl. MissingLink 12NR EPT • 25er Karton	<b>›X12 SILVER/BLACK‹</b> • 126 links • incl. MissingLink 12NR EPT • 25 pcs in a box	
<b>303545</b> 1 box	<b>›X11 SILVER/BLACK‹</b> • 118 Glieder • inkl. MissingLink 11R EPT, wiederverwendbar • 25er Karton	<b>›X11 SILVER/BLACK‹</b> • 118 links • incl. MissingLink 11R EPT, reusable • 25 pcs in a box	
<b>303575</b>	<b>›X10 SILVER/BLACK‹</b> • 116 Glieder • inkl. MissingLink 10R EPT, wiederverwendbar • 25er Karton	<b>›X10 SILVER/BLACK‹</b> • 116 links • incl. MissingLink 10R EPT, reusable • 25 pcs in a box	
<b>303576</b> 1 box	<b>›X10 GREY‹</b> • 116 Glieder • inkl. MissingLink 10R EPT, wiederverwendbar • 25er Karton	<b>›X10 GREY‹</b> • 116 links • incl. MissingLink 10R EPT, reusable • 25 pcs in a box	
<b>303615</b> 1 box	<b>›X9 SILVER/GREY‹</b> • 116 Glieder • inkl. MissingLink 9R EPT, wiederverwendbar • 25er Karton	<b>›X9 SILVER/GREY‹</b> • 116 links • incl. MissingLink 9R EPT, reusable • 25 pcs in a box	
<b>301085</b> 1 roll	150 Meter-Rolle (ohne Verschlussglied)	150 meter roll (w/o connecting link)	
<b>303616</b> 1 box	<b>›X9 GREY‹</b> • 116 Glieder • inkl. MissingLink 9R EPT, wiederverwendbar • 25er Karton	<b>›X9 GREY‹</b> • 116 links • incl. MissingLink 9R EPT, reusable • 25 pcs in a box	
<b>303623</b> 1 box	<b>›X8 SILVER/GREY‹</b> • 116 Glieder • inkl. MissingLink 7/8R EPT, wiederverwendbar • 25er Karton	<b>›X8 SILVER/GREY‹</b> • 116 links • incl. MissingLink 7/8R EPT, reusable • 25 pcs in a box	
<b>300583</b> 25 <b>300584</b> 1 roll	<b>›Z8 GREY‹</b> 116 Glieder (Endbolzen herausstehend)  150 Meter-Rolle	<b>›Z8 GREY‹</b> 116 links (protruding pins)  150 meter roll	
<b>300828</b> 50 <b>300367</b> 1 roll	<b>›HV500‹</b> 116 Glieder (Endbolzen herausstehend)  150 Meter-Rolle	<b>›HV500‹</b> 116 links (protruding pins)  150 meter roll	
<b>300353</b> 1 roll	<b>›S1 WIDE RB‹</b> • 1/2 x 1/8", Wide • 150 Meter-Rolle	<b>›S1 WIDE RB‹</b> • 1/2 x 1/8", Wide • 150 meter roll	

# KETTENVERSCHLUSSGLIEDER CHAIN CONNECTING LINKS



ART.-NR.	BESCHREIBUNG	DESCRIPTION	
<b>MISSINGLINKS</b>		<b>1/2" x 11/128"</b>	<b>MISSINGLINKS</b>
<b>302300</b>	›MissingLink 12NR DLC Black‹ <b>2 Stück</b> in KMC Blisterverpackung	›MissingLink 12NR DLC Black‹ <b>2 pcs</b> in KMC blister packaging UVP 18,90 €	 
<b>302301</b>	›MissingLink 12NR Ti-N Gold‹ <b>2 Stück</b> in KMC Blisterverpackung	›MissingLink 12NR Ti-N Gold‹ <b>2 pcs</b> in KMC blister packaging UVP 15,90 €	
<b>302302</b>	›MissingLink 12NR EPT Silver‹ <b>2 Stück</b> in KMC Blisterverpackung 1.000/50	›MissingLink 12NR EPT Silver‹ <b>2 pcs</b> in KMC blister packaging UVP 15,90 €	 
<b>302313</b>	40 Stück im Karton 1 box	40 pcs in a box	
<b>302303</b>	›MissingLink 11R DLC Black‹ • wiederverwendbar • <b>2 Stück</b> in KMC Blisterverpackung	›MissingLink 11R DLC Black‹ • reusable • <b>2 pcs</b> in KMC blister packaging UVP 18,90 €	  
<b>302304</b>	›MissingLink 11R Ti-N Gold‹ • wiederverwendbar • <b>2 Stück</b> in KMC Blisterverpackung	›MissingLink 11R Ti-N Gold‹ • reusable • <b>2 pcs</b> in KMC blister packaging UVP 15,90 €	
<b>302305</b>	›MissingLink 11R EPT‹ wiederverwendbar <b>2 Stück</b> in KMC Blisterverpackung 1.000/50	›MissingLink 11R EPT‹ reusable <b>2 pcs</b> in KMC blister packaging UVP 15,90 €	 
<b>302306</b>	40 Stück im Karton 1 box	40 pcs in a box	
<b>300003</b>	›CL-550NR‹ 50 Stück im Polybeutel (nicht wiederverwendbar)	›CL-550NR‹ 50 pcs in PE bag (non reusable)	
<b>302309</b>	›MissingLink 10R DLC Black‹ • wiederverwendbar • 5,88 mm • <b>2 Stück</b> in KMC Blisterverpackung	›MissingLink 10R DLC Black‹ • reusable • 5,88 mm • <b>2 pcs</b> in KMC blister packaging UVP 12,90 €	  
<b>302310</b>	›MissingLink 10R Ti-N Gold‹ • wiederverwendbar • 5,88 mm • <b>2 Stück</b> in KMC Blisterverpackung	›MissingLink 10R Ti-N Gold‹ • reusable • 5,88 mm • <b>2 pcs</b> in KMC blister packaging UVP 11,90 €	
<b>302311</b>	›MissingLink 10R EPT‹ wiederverwendbar <b>2 Stück</b> in KMC Blisterverpackung 1.000/50	›MissingLink 10R EPT‹ reusable <b>2 pcs</b> in KMC blister packaging UVP 11,90 €	 
<b>302312</b>	40 Stück im Karton 1 box	40 pcs in a box	
<b>300077</b>	›CL-559R‹ • wiederverwendbar • 50 Stück im Polybeutel	›CL-559R‹ • reusable • 50 pcs in PE bag	

ART.-NR.	BESCHREIBUNG	DESCRIPTION	
	›MissingLink 9R EPT Silver‹ • wiederverwendbar • 6,6 mm	›MissingLink 9R EPT Silver‹ • reusable • 6.6 mm	
<b>302314</b> 1.000/50	<b>2 Stück</b> in KMC Blisterverpackung	<b>2 pcs</b> in KMC blister packaging UVP 7,90 €	
<b>302315</b> 1 box	40 Stück im Karton	40 pcs in a box	
<b>300047</b> 2.000/50	›CL-566‹ 50 Stück im Polybeutel (nicht wiederverwendbar)	›CL-566‹ 50 pcs in PE bag (non reusable)	

MISSINGLINKS		1/2" x 3/32"	MISSINGLINKS	
	›MissingLink 7/8 EPT Silver 7.1‹ <b>7,1 mm</b>	›MissingLink 7/8 EPT Silver 7.1‹ <b>7.1 mm</b>		
<b>302323</b> 1.000/50	<b>2 Stück</b> in KMC Blisterverpackung wiederverwendbar	<b>2 pcs</b> in KMC blister packaging reusable UVP 5,90 €		
<b>300049</b> 2.000/50	50 Stück im Polybeutel	50 pcs in PE bag		
	›MissingLink 6/7/8 EPT Silver 7.3‹ <b>7,3 mm</b>	›MissingLink 6/7/8 EPT Silver 7.3‹ <b>7.3 mm</b>		
<b>302320</b> 1.000/50	<b>2 Stück</b> in KMC Blisterverpackung wiederverwendbar	<b>2 pcs</b> in KMC blister packaging reusable UVP 5,90 €		
<b>302321</b> 1 box	40 Stück im Karton wiederverwendbar	40 pcs in a box reusable		
<b>300045</b> 2.000/50	50 Stück im Polybeutel	50 pcs in PE bag		
	›MissingLink Z1eHX Narrow EPT Silver‹ • für <b>8,0 mm</b> Ketten (z. B. Art. 306134 Z1eHX Narrow EPT, ...) • <b>2 Stück</b> in KMC Blisterverpackung	›MissingLink Z1eHX Narrow EPT Silver‹ • for <b>8.0 mm</b> chains (e. g. art. 306134 Z1eHX Narrow EPT, ...) • <b>2 pcs</b> in KMC blister packaging UVP 8,90 €		
<b>302373</b>				
	›MissingLink e1 EPT Silver‹ • für <b>6,7-7,3 mm</b> breite Ketten (z. B. Art. 306120 e1, ...) • <b>2 Stück</b> in KMC Blisterverpackung	›MissingLink e1 EPT Silver‹ • for <b>6.7-7.3 mm</b> wide chains (e. g. art. 306120 e1, ...) • <b>2 pcs</b> in KMC blister packaging UVP 5,90 €		
<b>302367</b> 1.000/50				

SNAP-ON		1/2" x 1/8"	SNAP-ON	
	• für <b>8,6 mm</b> Ketten (z. B. Art. 303730/1, ...) • 50 Stück im Polybeutel	• for <b>8.6 mm</b> wide chains (e. g. art. 303730/1, ...) • 50 pcs in PE bag		
<b>301202</b>	›Snap-On Wide EPT Silver‹	›Snap-On Wide EPT Silver‹ UVP 79,90 €/100		
<b>300021</b> 2.000/50	›Snap-On Wide Grey‹	›Snap-On Wide Grey‹ UVP 69,90 €/100		

SNAP-ON		1/2" x 3/32"	SNAP-ON	
<b>300118</b> 1.000/50	›Snap-On Narrow Grey‹	›Snap-On Narrow Grey‹ UVP 99,90 €/100		

**NEW**

ART.-NR.	BESCHREIBUNG	DESCRIPTION	
<b>HALBKETTENNIETGLIED</b>		<b>OFFSET/HALF LINK</b>	
	<ul style="list-style-type: none"> <li>• braun</li> <li>• 50 Stück im Polybeutel</li> </ul>	<ul style="list-style-type: none"> <li>• brown</li> <li>• 50 pcs in PE bag</li> </ul>	
<b>300024</b>	›Half Link Narrow‹ 1/2" x 3/32"	›Half Link Narrow‹ 1/2" x 3/32"	
<b>300023</b> 2.000/50	›Half Link Wide‹ 1/2" x 1/8"	›Half Link Wide‹ 1/2" x 1/8"	UVP 159,90 €/100
<b>KETTENVERSCHLUSSGLIED-SPEZIALZANGEN</b>		<b>CONNECTING LINK-SPECIAL PLIERS</b>	
	<ul style="list-style-type: none"> <li>• spezielles Werkzeug zum leichten Öffnen bzw. Schließen von Kettenverschlussgliedern (z. B. MissingLinks, ...)</li> <li>• mit schwarzen <b>Non-Slip Griffen</b></li> <li>• auf KMC Eurolochkarte</li> </ul>	<ul style="list-style-type: none"> <li>• special tool for easy unlocking or rather locking of connecting links (e. g. MissingLinks, ...)</li> <li>• with black <b>non-slip grips</b></li> <li>• on KMC eurohole card</li> </ul>	<b>PROFIQUALITÄT</b> 
<b>880454</b>	Zange zum Öffnen	pliers for unlocking	
<b>880455</b> 25	Zange zum Schließen	pliers for locking	UVP 11,90 €
<b>880449</b> 25	<b>KETTENNIETDRÜCKER</b>	<b>CHAIN RIVETING TOOL</b>	
	<ul style="list-style-type: none"> <li>• <b>hochwertige Ausführung</b></li> <li>• für <b>1-12-fach</b> Ketten</li> <li>• kunststoffummantelter <b>Non-Slip Griff</b></li> <li>• <b>Ersatzstift</b> durch <b>drehbaren</b> Nietstift</li> <li>• mit <b>zusätzlichem Ersatzstift</b> (Art. 880289)</li> <li>• auf KMC Eurolochkarte</li> </ul>	<ul style="list-style-type: none"> <li>• <b>high quality</b></li> <li>• for <b>1-12 speed</b> chains</li> <li>• plastic coated <b>non-slip handle</b></li> <li>• <b>replacement bolt</b> by <b>turnable</b> riveting bolt</li> <li>• with <b>additional replacement bolt</b> (art. 880289)</li> <li>• on KMC eurohole card</li> </ul>	<p>replacement bolt (art. 880289)</p>
			UVP 25,90 €
<b>880435</b> 25	<b>KETTENNIETDRÜCKER ›MINI CHAIN TOOL KMC‹</b>	<b>CHAIN RIVETING TOOL ›MINI CHAIN TOOL KMC‹</b>	
	<ul style="list-style-type: none"> <li>• <b>hochwertige Ausführung</b> für unterwegs</li> <li>• für <b>9-12-fach</b> Ketten</li> <li>• Aluminium</li> <li>• nur <b>46 g</b>, nur 68 x 29 mm</li> <li>• mit Neopren-Aufbewahrungshülle</li> <li>• in KMC Blisterverpackung</li> </ul>	<ul style="list-style-type: none"> <li>• <b>high quality</b> on the way</li> <li>• for <b>9-12 speed</b> chains</li> <li>• aluminium</li> <li>• only <b>46 g</b>, only 68 x 29 mm</li> <li>• with neoprene storage case</li> <li>• in KMC blister packaging</li> </ul>	
			UVP 23,90 €
<b>880462</b> 50	<b>MULTITOOL ›CHAIN AID‹</b>	<b>MULTITOOL ›CHAIN AID‹</b>	
	<ul style="list-style-type: none"> <li>• <b>5 in 1</b></li> <li>• Reifenheber</li> <li>• Kettenschlossaufbewahrung (Kettenschloss nicht im Lieferumfang enthalten)</li> <li>• Kettenhalter</li> <li>• Repair Chain Drop</li> <li>• Ventileinsatzwerkzeug für FV</li> <li>• auf KMC Eurolochkarte</li> </ul>	<ul style="list-style-type: none"> <li>• <b>5 in 1</b></li> <li>• tire lever</li> <li>• missing link storage (missing link not included)</li> <li>• chain latch</li> <li>• repair chain drop</li> <li>• valve core tool for FV</li> <li>• on KMC eurohole card</li> </ul>	<p><b>5 in 1</b></p>
			UVP 5,90 €

Falls Sie Interesse an weiteren KMC-Produkten haben, die wir nicht im Katalog führen, so bieten wir Ihnen diese natürlich auch gerne an.  
If you are interested in KMC-products which are not in our catalogue we would be pleased to offer them to you directly.



## M-WAVE E-BIKE KETTEN

Mit den E-Bike Ketten für 1-11-fach Systeme schafft es M-Wave haltbare und bezahlbare Ketten zu realisieren.

Natürlich sind sie für alle gängigen E-Motoren geeignet.

Auch im Programm: ein komplettes Sortiment von Antirost-Ketten, die für alle Schaltsysteme von Singlespeed bis 11-fach passen.













## M-WAVE E-BIKE CHAINS



















With the e-bike chains for 1-11 speed systems M-Wave manages to create durable and affordable e-bike chains.

Of course, they are suitable for all common e-bike engines.

Also in the assortment: a complete range of anti rust chains that fit all gear systems from single speed to 11 speed.









	<p>›ELEVENSPEED‹</p> <ul style="list-style-type: none"> <li>• für <b>11-fach</b> Schaltungssysteme</li> <li>• 1/2" x 11/128"</li> <li>• 116 Glieder</li> <li>• mit Verschlussglied</li> <li>• im M-Wave Einzelkarton</li> </ul>	<p>›ELEVENSPEED‹</p> <ul style="list-style-type: none"> <li>• for <b>11 speed</b></li> <li>• 1/2" x 11/128"</li> <li>• 116 links</li> <li>• with connecting link</li> <li>• in M-Wave box</li> </ul>	 
<p><b>301941</b></p> <p>30</p>	<p>›Elevenspeed E‹</p> <ul style="list-style-type: none"> <li>• besonders geeignet für <b>E-Bikes</b></li> <li>• <b>längere Haltbarkeit</b> durch Verstärkungen</li> <li>• für <b>Brose, Bosch, Shimano, Bafang, ...</b> Antriebe</li> <li>• grau</li> </ul>	<p>›Elevenspeed E‹</p> <ul style="list-style-type: none"> <li>• particularly suitable for <b>e-bikes</b></li> <li>• <b>longer durability</b> due to reinforcements</li> <li>• for <b>Brose, Bosch, Shimano, Bafang, ...</b> drives</li> <li>• grey</li> </ul> <p>UVP 41,90 €</p>	
<p><b>301911</b></p>	<p>›Elevenspeed AR‹</p> <ul style="list-style-type: none"> <li>• mit <b>Antirost-Beschichtung</b></li> <li>• kompatibel zu <b>Shimano / Sram / Campagnolo</b></li> <li>• silber</li> </ul>	<p>›Elevenspeed AR‹</p> <ul style="list-style-type: none"> <li>• with <b>anti rust coating</b></li> <li>• compatible with <b>Shimano / Sram / Campagnolo</b></li> <li>• silver</li> </ul> <p>UVP 39,90 €</p>	 
<p><b>301906</b></p> <p>60</p>	<p>›Elevenspeed‹</p> <ul style="list-style-type: none"> <li>• kompatibel zu <b>Shimano / Sram / Campagnolo</b></li> <li>• dunkelgrau</li> </ul>	<p>›Elevenspeed‹</p> <ul style="list-style-type: none"> <li>• compatible with <b>Shimano / Sram / Campagnolo</b></li> <li>• dark grey</li> </ul> <p>UVP 26,90 €</p>	
	<p>›TENSPEED‹</p> <ul style="list-style-type: none"> <li>• für <b>10-fach</b> Schaltungssysteme</li> <li>• 1/2" x 11/128"</li> <li>• 116 Glieder</li> <li>• mit Verschlussglied</li> <li>• im M-Wave Einzelkarton</li> </ul>	<p>›TENSPEED‹</p> <ul style="list-style-type: none"> <li>• for <b>10 speed</b></li> <li>• 1/2" x 11/128"</li> <li>• 116 links</li> <li>• with connecting link</li> <li>• in M-Wave box</li> </ul>	 
<p><b>301940</b></p> <p>30</p>	<p>›Tenspeed E‹</p> <ul style="list-style-type: none"> <li>• besonders geeignet für <b>E-Bikes</b></li> <li>• <b>längere Haltbarkeit</b> durch Verstärkungen</li> <li>• für <b>Brose, Bosch, Shimano, Bafang, ...</b> Antriebe</li> <li>• grau</li> </ul>	<p>›Tenspeed E‹</p> <ul style="list-style-type: none"> <li>• particularly suitable for <b>e-bikes</b></li> <li>• <b>longer durability</b> due to reinforcements</li> <li>• for <b>Brose, Bosch, Shimano, Bafang, ...</b> drives</li> <li>• grey</li> </ul> <p>UVP 37,90 €</p>	
<p><b>301910</b></p>	<p>›Tenspeed AR‹</p> <ul style="list-style-type: none"> <li>• mit <b>Antirost-Beschichtung</b></li> <li>• kompatibel zu <b>Shimano / Sram / Campagnolo</b></li> <li>• silber</li> </ul>	<p>›Tenspeed AR‹</p> <ul style="list-style-type: none"> <li>• with <b>anti rust coating</b></li> <li>• compatible with <b>Shimano / Sram / Campagnolo</b></li> <li>• silver</li> </ul> <p>UVP 37,90 €</p>	 
<p><b>301901</b></p> <p>60</p>	<p>›Tenspeed‹</p> <ul style="list-style-type: none"> <li>• kompatibel zu <b>Shimano / Sram / Campagnolo</b></li> <li>• nur <b>259 g</b> (110 Gl.)</li> <li>• dunkelgrau</li> </ul>	<p>›Tenspeed‹</p> <ul style="list-style-type: none"> <li>• compatible with <b>Shimano / Sram / Campagnolo</b></li> <li>• only <b>259 g</b> (110 li.)</li> <li>• dark grey</li> </ul> <p>UVP 26,90 €</p>	

ART.-NR.	BESCHREIBUNG	DESCRIPTION	
	<p>›NINESPEED‹</p> <ul style="list-style-type: none"> <li>• für <b>9-fach</b> Schaltungssysteme</li> <li>• 1/2" x 11/128"</li> <li>• 116 Glieder</li> <li>• mit Verschlussglied</li> <li>• im M-Wave Einzelkarton</li> </ul>	<p>›NINESPEED‹</p> <ul style="list-style-type: none"> <li>• for <b>9 speed</b></li> <li>• 1/2" x 11/128"</li> <li>• 116 links</li> <li>• with connecting link</li> <li>• in M-Wave box</li> </ul>	 
<b>301909</b>	<p>›Ninespeed AR‹</p> <ul style="list-style-type: none"> <li>• mit <b>Antirost-Beschichtung</b></li> <li>• kompatibel zu <b>Shimano / Sram / Campagnolo</b></li> <li>• silber</li> </ul>	<p>›Ninespeed AR‹</p> <ul style="list-style-type: none"> <li>• with <b>anti rust coating</b></li> <li>• compatible with <b>Shimano / Sram / Campagnolo</b></li> <li>• silver</li> </ul> <p>UVP 29,90 €</p>	 
<b>301902</b> 60	<p>›Ninespeed‹</p> <ul style="list-style-type: none"> <li>• kompatibel zu <b>Shimano / Sram / Campagnolo</b></li> <li>• dunkelgrau</li> </ul>	<p>›Ninespeed‹</p> <ul style="list-style-type: none"> <li>• compatible with <b>Shimano / Sram / Campagnolo</b></li> <li>• dark grey</li> </ul> <p>UVP 19,90 €</p>	
	<p>›EIGHTSPEED‹</p> <ul style="list-style-type: none"> <li>• für <b>8, 7, 6-fach</b> Schaltungssysteme</li> <li>• auch für <b>Nabenschaltungen</b> geeignet</li> <li>• 1/2" x 3/32"</li> <li>• 116 Glieder</li> <li>• mit Verschlussglied</li> <li>• im M-Wave Einzelkarton</li> </ul>	<p>›EIGHTSPEED‹</p> <ul style="list-style-type: none"> <li>• for <b>8, 7, 6 speed</b></li> <li>• also suitable for <b>internal gear hubs</b></li> <li>• 1/2" x 3/32"</li> <li>• 116 links</li> <li>• with connecting link</li> <li>• in M-Wave box</li> </ul>	 
<b>301908</b>	<p>›Eightspeed AR‹</p> <ul style="list-style-type: none"> <li>• mit <b>Antirost-Beschichtung</b></li> <li>• silber</li> </ul>	<p>›Eightspeed AR‹</p> <ul style="list-style-type: none"> <li>• with <b>anti rust coating</b></li> <li>• silver</li> </ul> <p>UVP 19,90 €</p>	 
<b>301907</b> 60	<p>›Eightspeed‹</p> <ul style="list-style-type: none"> <li>• silber / grau</li> </ul>	<p>›Eightspeed‹</p> <ul style="list-style-type: none"> <li>• silver / grey</li> </ul> <p>UVP 11,90 €</p>	
<b>301904</b> 60	<p>›SEVENSPEED‹</p> <ul style="list-style-type: none"> <li>• für <b>7, 6, 5, 1-fach</b> Schaltungssysteme</li> <li>• 1/2" x 3/32"</li> <li>• 116 Glieder</li> <li>• 7,3 mm</li> <li>• grau / braun</li> <li>• mit Verschlussglied</li> <li>• im M-Wave Einzelkarton</li> </ul>	<p>›SEVENSPEED‹</p> <ul style="list-style-type: none"> <li>• for <b>7, 6, 5, 1 speed</b></li> <li>• 1/2" x 3/32"</li> <li>• 116 links</li> <li>• 7,3 mm</li> <li>• grey / brown</li> <li>• with connecting link</li> <li>• in M-Wave box</li> </ul> <p>UVP 7,90 €</p>	 
	<p>›SINGLESPEED‹</p> <ul style="list-style-type: none"> <li>• für <b>1-fach</b></li> <li>• auch für <b>Nabenschaltungen</b> geeignet</li> <li>• 112 Glieder</li> <li>• mit Verschlussglied</li> <li>• im M-Wave Einzelkarton</li> </ul>	<p>›SINGLESPEED‹</p> <ul style="list-style-type: none"> <li>• for <b>1 speed</b></li> <li>• also suitable for <b>internal gear hubs</b></li> <li>• 112 links</li> <li>• with connecting link</li> <li>• in M-Wave single box</li> </ul>	 
<b>301945</b> 30	<p>›Singlespeed E‹</p> <ul style="list-style-type: none"> <li>• besonders geeignet für <b>E-Bikes</b></li> <li>• <b>längere Haltbarkeit</b> durch Verstärkungen</li> <li>• für <b>Brose, Bosch, Shimano, Bafang, ...</b> Antriebe</li> <li>• 1/2" x 3/32"</li> <li>• silber</li> </ul>	<p>›Singlespeed E‹</p> <ul style="list-style-type: none"> <li>• particularly suitable for <b>e-bikes</b></li> <li>• <b>longer durability</b> due to reinforcements</li> <li>• for <b>Brose, Bosch, Shimano, Bafang, ...</b> drives</li> <li>• 1/2" x 3/32"</li> <li>• silver</li> </ul> <p>UVP 17,90 €</p>	 
<b>301915</b>	<p>›Singlespeed AR‹</p> <ul style="list-style-type: none"> <li>• mit <b>Antirost-Beschichtung</b></li> <li>• 1/2" x 1/8"</li> <li>• silber</li> </ul>	<p>›Singlespeed AR‹</p> <ul style="list-style-type: none"> <li>• with <b>anti rust coating</b></li> <li>• 1/2" x 1/8"</li> <li>• silver</li> </ul> <p>UVP 9,90 €</p>	 
<b>301905</b> 60	<p>›Singlespeed‹</p> <ul style="list-style-type: none"> <li>• 1/2" x 1/8"</li> <li>• grau / braun</li> </ul>	<p>›Singlespeed‹</p> <ul style="list-style-type: none"> <li>• 1/2" x 1/8"</li> <li>• grey / brown</li> </ul> <p>UVP 4,90 €</p>	

ART.-NR.	BESCHREIBUNG	DESCRIPTION
----------	--------------	-------------

## FÜR WERKSTÄTTEN UND MONTAGEN

## FOR WORKSHOPS AND FACTORIES

















<b>301970</b> 1 roll	<b>KETTEN AUF ROLLE</b> <ul style="list-style-type: none"> <li>• <b>15 m Rolle</b></li> <li>• inkl. 10 Verschlussgliedern</li> <li>• im praktischen braunen Karton zum Abrollen</li> </ul> <ul style="list-style-type: none"> <li>• für <b>11-fach</b> Schaltungssysteme</li> <li>• 1/2" x 11/128"</li> <li>• kompatibel zu <b>Shimano / Sram / Campagnolo</b></li> <li>• grau</li> </ul>	<b>CHAINS ON ROLL</b> <ul style="list-style-type: none"> <li>• <b>15 m roll</b></li> <li>• incl. 10 chain connecting links</li> <li>• in practical brown box to roll off</li> </ul> <ul style="list-style-type: none"> <li>• for <b>11 speed</b></li> <li>• 1/2" x 11/128"</li> <li>• compatible with <b>Shimano / Sram / Campagnolo</b></li> <li>• grey</li> </ul>	<div style="border: 1px solid black; padding: 2px; display: inline-block;">15 m</div>   <div style="border: 1px solid black; border-radius: 50%; padding: 2px; display: inline-block;">11 Speed</div>
<b>301971</b> 1 roll	<ul style="list-style-type: none"> <li>• für <b>10-fach</b> Schaltungssysteme</li> <li>• 1/2" x 11/128"</li> <li>• kompatibel zu <b>Shimano / Sram / Campagnolo</b></li> <li>• grau</li> </ul>	<ul style="list-style-type: none"> <li>• for <b>10 speed</b></li> <li>• 1/2" x 11/128"</li> <li>• compatible with <b>Shimano / Sram / Campagnolo</b></li> <li>• grey</li> </ul>	 <div style="border: 1px solid black; border-radius: 50%; padding: 2px; display: inline-block;">10 Speed</div>
<b>301972</b> 1 roll	<ul style="list-style-type: none"> <li>• für <b>9-fach</b> Schaltungssysteme</li> <li>• 1/2" x 11/128"</li> <li>• kompatibel zu <b>Shimano / Sram / Campagnolo</b></li> <li>• grau</li> </ul>	<ul style="list-style-type: none"> <li>• for <b>9 speed</b></li> <li>• 1/2" x 11/128"</li> <li>• compatible with <b>Shimano / Sram / Campagnolo</b></li> <li>• grey</li> </ul>	 <div style="border: 1px solid black; border-radius: 50%; padding: 2px; display: inline-block;">9 Speed</div>
<b>301973</b> 1 roll	<ul style="list-style-type: none"> <li>• für <b>8, 7, 6, 1-fach</b> Schaltungssysteme</li> <li>• auch für <b>Nabenschaltungen</b> geeignet</li> <li>• 1/2" x 3/32"</li> <li>• silber/grau</li> </ul>	<ul style="list-style-type: none"> <li>• for <b>8, 7, 6, 1 speed</b></li> <li>• also suitable for <b>internal gear hubs</b></li> <li>• 1/2" x 3/32"</li> <li>• silver/grey</li> </ul>	 <div style="display: flex; gap: 5px;"> <div style="border: 1px solid black; border-radius: 50%; padding: 2px;">1</div> <div style="border: 1px solid black; border-radius: 50%; padding: 2px;">6</div> <div style="border: 1px solid black; border-radius: 50%; padding: 2px;">7</div> <div style="border: 1px solid black; border-radius: 50%; padding: 2px;">8</div> </div>
<b>301974</b> 1 roll	<ul style="list-style-type: none"> <li>• für <b>7, 6, 5, 1-fach</b> Schaltungssysteme</li> <li>• auch für <b>Nabenschaltungen</b> geeignet</li> <li>• 1/2" x 3/32"</li> <li>• 7,3 mm</li> <li>• grau / braun</li> </ul>	<ul style="list-style-type: none"> <li>• for <b>7, 6, 5, 1 speed</b></li> <li>• also suitable for <b>internal gear hubs</b></li> <li>• 1/2" x 3/32"</li> <li>• 7.3 mm</li> <li>• grey / brown</li> </ul>	 <div style="display: flex; gap: 5px;"> <div style="border: 1px solid black; border-radius: 50%; padding: 2px;">1</div> <div style="border: 1px solid black; border-radius: 50%; padding: 2px;">5</div> <div style="border: 1px solid black; border-radius: 50%; padding: 2px;">6</div> <div style="border: 1px solid black; border-radius: 50%; padding: 2px;">7</div> </div>
<b>301975</b> 1 roll	<ul style="list-style-type: none"> <li>• für <b>1-fach</b> Schaltungssysteme</li> <li>• auch für <b>Nabenschaltungen</b> geeignet</li> <li>• 1/2" x 1/8"</li> <li>• braun</li> </ul>	<ul style="list-style-type: none"> <li>• for <b>1 speed</b></li> <li>• also suitable for <b>internal gear hubs</b></li> <li>• 1/2" x 1/8"</li> <li>• brown</li> </ul>	 <div style="border: 1px solid black; border-radius: 50%; padding: 2px; display: inline-block;">1 Speed</div>







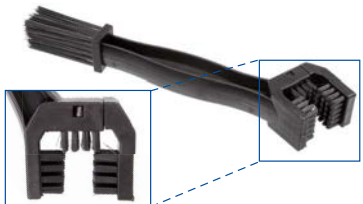









ART.-NR. 	BESCHREIBUNG	DESCRIPTION	
	<b>M-WAVE VERSCHLUSSGLIED</b>	<b>M-WAVE CHAIN CONNECTING LINK</b>	
<b>301926</b> 1.000/50	<ul style="list-style-type: none"> <li>wiederverwendbar</li> <li>1 Set auf Eurolochkarte</li> </ul> <p>›Fusion 11‹</p> <ul style="list-style-type: none"> <li>für 11-fach Kette 1/2" x 11/128"</li> <li>passend für M-Wave, <b>Sram, Shimano, KMC</b>, ...</li> </ul>	<ul style="list-style-type: none"> <li>reusable</li> <li>1 set on eurohole card</li> </ul> <p>›Fusion 11‹</p> <ul style="list-style-type: none"> <li>for 11 speed chain 1/2" x 11/128"</li> <li>suitable for M-Wave, <b>Sram, Shimano, KMC</b></li> </ul> <p>UVP 9,90 €</p>	 
<b>301920</b> 1.000/50	<p>›Fusion 10‹</p> <ul style="list-style-type: none"> <li>für 10-fach Ketten</li> <li>5,88 mm</li> <li>passend für M-Wave, <b>Sram, Shimano, KMC</b>, ...</li> </ul>	<p>›Fusion 10‹</p> <ul style="list-style-type: none"> <li>for 10 speed chains</li> <li>5,88 mm</li> <li>suitable for M-Wave, <b>Sram, Shimano, KMC</b></li> </ul> <p>UVP 5,90 €</p>	 
<b>301921</b> 1.000/50	<p>›Fusion 9‹</p> <ul style="list-style-type: none"> <li>für 9-fach Ketten</li> <li>6,6 mm</li> <li>passend für M-Wave, <b>Sram, Shimano, KMC</b>, ...</li> </ul>	<p>›Fusion 9‹</p> <ul style="list-style-type: none"> <li>for 9 speed chains</li> <li>6,6 mm</li> <li>suitable for M-Wave, <b>Sram, Shimano, KMC</b></li> </ul> <p>UVP 4,90 €</p>	 
<b>301925</b> 1.000/50	<p>›Fusion 5-8‹</p> <ul style="list-style-type: none"> <li>für (5/6/7) 8-fach Ketten</li> <li>7,3 mm</li> </ul>	<p>›Fusion 5-8‹</p> <ul style="list-style-type: none"> <li>for (5/6/7) 8 speed chains</li> <li>7,3 mm</li> </ul> <p>UVP 3,90 €</p>	     
<b>301924</b> 1.000/50	<p><b>SNAP ON VERSCHLUSSGLIED</b></p> <p>›FUSION 1‹</p> <ul style="list-style-type: none"> <li>für 1-fach 1/2" x 1/8"</li> <li>grau</li> <li>8 mm</li> <li>1 Set auf Eurolochkarte</li> </ul>	<p><b>SNAP ON CONNECTOR</b></p> <p>›FUSION 1‹</p> <ul style="list-style-type: none"> <li>for single speed 1/2" x 1/8"</li> <li>grey</li> <li>8 mm</li> <li>1 set on eurohole card</li> </ul> <p>UVP 2,49 €</p>	  
	<b>FAHRRADKETTEN VENTURA</b>	<b>BICYCLE CHAINS VENTURA</b>	
<b>302175</b> 60	<ul style="list-style-type: none"> <li>116 Glieder</li> <li>in Eurolochbox</li> </ul> <p>für <b>8, 7-fach</b> Schaltungssysteme</p> <ul style="list-style-type: none"> <li>1/2" x 3/32"</li> <li>grau/braun</li> </ul>	<ul style="list-style-type: none"> <li>116 links</li> <li>in eurohole box</li> </ul> <p>for <b>8, 7 speed</b></p> <ul style="list-style-type: none"> <li>1/2" x 3/32"</li> <li>grey/brown</li> </ul> <p>UVP 8,90 €</p>	  
<b>302165</b> 60	<p>für <b>7, 6, 5, 1-fach</b> Schaltungssysteme</p> <ul style="list-style-type: none"> <li>1/2" x 3/32"</li> <li>schwarz/braun</li> </ul>	<p>for <b>7, 6, 5, 1 speed</b></p> <ul style="list-style-type: none"> <li>1/2" x 3/32"</li> <li>black/brown</li> </ul> <p>UVP 6,90 €</p>	    
<b>301125</b> 60	<p>für <b>1-fach</b></p> <ul style="list-style-type: none"> <li>1/2" x 1/8"</li> <li>112 Glieder</li> <li>mit Federverschlussglied</li> <li>in Eurolochbox</li> </ul>	<p>for <b>single speed</b></p> <ul style="list-style-type: none"> <li>1/2" x 1/8"</li> <li>112 links</li> <li>with connecting link</li> <li>in eurohole box</li> </ul> <p>UVP 4,90 €</p>	  
<b>301525</b> 1 roll	<p>für <b>1-fach</b></p> <ul style="list-style-type: none"> <li>1/2" x 1/8"</li> <li>auf 150 Meter-Rolle</li> </ul>	<p>for <b>single speed</b></p> <ul style="list-style-type: none"> <li>1/2" x 1/8"</li> <li>on 150 meter roll</li> </ul>	

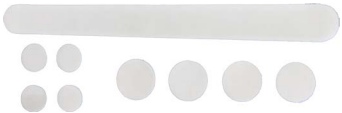

ART.-NR. 	BESCHREIBUNG	DESCRIPTION	
<p><b>TIP</b></p> <p><b>307010</b> 20 set</p>	<p><b>POWER-REPARATURSET AUS KETTE UND KASSETTE</b></p> <p>Da meist <b>beides zugleich erneuert</b> werden sollte: Hier unser Set-Angebot. Pushen Sie den Umsatz Ihrer Werkstatt/ Service.</p> <ul style="list-style-type: none"> <li>hochwertige <b>Kette</b> mit 116 Gliedern mit <b>dazu passendem Kassettenzahnkranz</b>, Shimano kompatibel (kein original Shimano Ersatzteil)</li> <li>Set im Karton</li> </ul> <p><b>10-fach</b> bestehend aus Kette Art. 301901 und Kassettenzahnkranz 11 - 36 Zähne (Art. 700194)</p>	<p><b>POWER REPAIR SET OF CHAIN AND CASSETTE</b></p> <p>Because <b>both parts should be replaced at the same time</b>: Our latest set-offer. Increase the sales of your repair shop/ service.</p> <ul style="list-style-type: none"> <li>high quality <b>chain</b> with 116 links with <b>matching cassette sprocket</b>, Shimano compatible (no original Shimano spare part)</li> <li>set in box</li> </ul> <p><b>10 speed</b> consisting of chain art. 301901 and cassette sprocket 11 - 36 teeth (art. 700194)</p> <p>UVP 59,90 €</p>	
<p><b>307011</b> 20 set</p>	<p><b>9-fach</b> bestehend aus Kette Art. 301902 und Kassettenzahnkranz 11 - 32 Zähne (Art. 700195)</p>	<p><b>9 speed</b> consisting of chain art. 301902 and cassette sprocket 11 - 32 teeth (art. 700195)</p> <p>UVP 46,90 €</p>	
<p><b>307012</b> 20 set</p>	<p><b>8-fach</b> bestehend aus Kette Art. 302175 und Kassettenzahnkranz 11 - 32 Zähne (Art. 700168)</p>	<p><b>8 speed</b> consisting of chain art. 302175 and cassette sprocket 11 - 32 teeth (art. 700168)</p> <p>UVP 34,90 €</p>	
<p><b>307013</b> 20 set</p>	<p><b>7-fach</b> bestehend aus Kette Art. 302165 und Kassettenzahnkranz 12 - 28 Zähne (Art. 700167)</p>	<p><b>7 speed</b> consisting of chain art. 302165 and cassette sprocket 12 - 28 teeth (art. 700167)</p> <p>UVP 27,90 €</p>	
<p><b>300010</b> 5.000/100</p>	<p><b>FEDERVERSCHLUSSGLIED</b></p> <ul style="list-style-type: none"> <li>1/2" x 1/8"</li> <li>100 Stück im Polybeutel</li> </ul>	<p><b>SPRING CLIP</b></p> <ul style="list-style-type: none"> <li>1/2" x 1/8"</li> <li>100 pieces in PE bag</li> </ul> <p>UVP 16,90 €/100</p>	
<p><b>300087</b> 5.000/100</p>	<p><b>KETTENVERSCHLUSSGLIED</b></p> <ul style="list-style-type: none"> <li>für Schaltungskette</li> <li>1/2" x 3/32"</li> <li>100 Stück im Polybeutel</li> </ul>	<p><b>SPECIAL CONNECTING LINK</b></p> <ul style="list-style-type: none"> <li>for derailleur chain</li> <li>1/2" x 3/32"</li> <li>100 pieces in PE bag</li> </ul> <p>UVP 12,90 €/100</p>	

ART.-NR. 	BESCHREIBUNG	DESCRIPTION	
<b>300199</b> 20	<b>KETTENREINIGUNGSGERÄT ›TB-3208‹</b> <ul style="list-style-type: none"> <li>• <b>einfache, schnelle und zuverlässige 3D-Reinigung</b></li> <li>• <b>keine Demontage der Kette nötig</b></li> <li>• großer Flüssigkeitstank</li> <li>• <b>3 kugelgelagerte Reinigungsbürsten</b></li> <li>• 2 Schwämme zum Entfernen überschüssiger Flüssigkeit</li> <li>• mit <b>Magnet</b> am Tankboden um Metallpartikel abziehen</li> <li>• Einfüllöffnung um Reinigungsflüssigkeit und Kettenöl <b>gezielt aufzutragen</b></li> <li>• in Super B Blisterverpackung</li> </ul>	<b>CHAIN CLEANER ›TB-3208‹</b> <ul style="list-style-type: none"> <li>• <b>easy, fast and reliable 3D cleaning</b></li> <li>• <b>no need to remove the chain</b></li> <li>• large liquid tank</li> <li>• <b>3 cleaning brushes with ball bearings</b></li> <li>• 2 sponges to remove excessive liquid</li> <li>• with <b>magnet</b> at the tank bottom to remove metal particles</li> <li>• filling hole for <b>applying</b> cleaner and chain lube separately and <b>precisely</b></li> <li>• in Super B blister packaging</li> </ul> <p style="text-align: right;">UVP 26,90 €</p>	   
<b>300006</b> 50	<b>KETTENREINIGUNGSGERÄT</b> <ul style="list-style-type: none"> <li>• mit Nylonbürsten</li> <li>• keine Demontage der Kette nötig</li> <li>• für alle Kettenschaltungen</li> <li>• inkl. <b>Reinigungsflüssigkeit</b> und <b>Öl</b></li> <li>• in Blisterverpackung</li> </ul>	<b>CHAIN CLEANER</b> <ul style="list-style-type: none"> <li>• with nylon brushes</li> <li>• no need to remove the chain</li> <li>• for multiple speed</li> <li>• incl. <b>cleaner</b> and <b>oil</b></li> <li>• in blister packaging</li> </ul> <p style="text-align: right;">UVP 12,90 €</p>	  
<b>300004</b> 66	<b>KETTENREINIGUNGSGERÄT</b> <ul style="list-style-type: none"> <li>• mit Nylonbürsten</li> <li>• keine Demontage der Kette nötig</li> <li>• für alle Kettenschaltungen</li> <li>• inkl. <b>Reinigungsflüssigkeit</b></li> <li>• im Einzelkarton</li> </ul>	<b>CHAIN CLEANER</b> <ul style="list-style-type: none"> <li>• with nylon brushes</li> <li>• no need to remove the chain</li> <li>• for multiple speed</li> <li>• incl. <b>cleaner</b></li> <li>• in box</li> </ul> <p style="text-align: right;">UVP 11,90 €</p>	  
<b>300198</b> 50  <b>NICE PRICE</b>	<b>KETTENREINIGUNGSGERÄT ›CHAINCUZZI‹</b> <ul style="list-style-type: none"> <li>• <b>keine Demontage der Kette nötig</b></li> <li>• <b>3 Reinigungsbürsten</b></li> <li>• Gummilippen zum Entfernen überschüssiger Flüssigkeit und Metallpartikel</li> <li>• auf Eurolochkarte</li> </ul>	<b>CHAIN CLEANER ›CHAINCUZZI‹</b> <ul style="list-style-type: none"> <li>• <b>no need to remove the chain</b></li> <li>• <b>3 cleaning brushes</b></li> <li>• rubber lips for removing excessive liquid and metal particles</li> <li>• on eurohole card</li> </ul> <p style="text-align: right;">UVP 7,90 €</p>	   
<b>880407</b> 200	<b>REINIGUNGSBÜRSTE</b> <ul style="list-style-type: none"> <li>• speziell zum <b>Reinigen von Ketten</b> von <b>3 Seiten gleichzeitig</b></li> <li>• auch für andere Teile (z. B. Kassette, Umwerfer, ...)</li> <li>• stabiler Kunststoffgriff</li> <li>• im Polybeutel mit Barcode-Aufkleber</li> </ul>	<b>CLEANING BRUSH</b> <ul style="list-style-type: none"> <li>• especially for <b>cleaning chains 3 sides simultaneously</b></li> <li>• also for other parts (e. g. cassette, front derailleur, ...)</li> <li>• stable plastic handle</li> <li>• in PE bag with barcode sticker</li> </ul> <p style="text-align: right;">UVP 3,90 €</p>	 

ART.-NR.	BESCHREIBUNG	DESCRIPTION	
<p><b>303310</b></p> <p>200</p>	<p><b>KETTENFÜHRUNG</b></p> <ul style="list-style-type: none"> <li>zur <b>Erhöhung der Kettenspannung</b>, um Herabfallen und Schlagen der Kette zu verhindern</li> <li>geeignet für <b>1-3-fach</b> Kettenradgarnituren</li> <li>passend für alle Räder <b>mit oder ohne durchgehende Zugverlegung</b> unter der Kettenstrebe</li> <li>Montage am <b>Zugführungshalter</b> oder <b>Kettenstrebe</b> möglich</li> <li>aus hochwertigem <b>Nylon</b></li> <li>im Exustar Einzelkarton</li> </ul>	<p><b>CHAIN GUIDE</b></p> <ul style="list-style-type: none"> <li>for <b>raising the chain tension</b>, in order to prevent the chain from falling down or knocking around</li> <li>suitable for <b>1-3-speed</b> chainwheel sets</li> <li>suitable for all bikes <b>with or without nonstop cable routing</b> under the chain stay</li> <li>mounting at <b>cable guide</b> or <b>chain stay</b> is possible</li> <li>made of high grade <b>nylon</b></li> <li>in Exustar box</li> </ul> <p>UVP 27,90 €</p> 	 
<p><b>303311</b></p> <p>50/10</p>	<p><b>KETTENFÜHRUNG ›STEWARD UP‹</b></p> <ul style="list-style-type: none"> <li>geeignet für <b>1-fach</b> Kettenradgarnituren</li> <li>Montage am <b>Sattelrohr</b> Ø 34,9 mm (inkl. Adapter für 31,8 mm)</li> <li>aus hochwertigem <b>Nylon-</b> und <b>Glasfasern</b></li> <li><b>Aluminium</b>-Klemme</li> <li>Höhenverstellung: 15 mm</li> <li>nur 77 g (ohne Adapter)</li> <li>auf M-Wave Eurolochkarte</li> </ul>	<p><b>CHAIN GUIDE ›STEWARD UP‹</b></p> <ul style="list-style-type: none"> <li>suitable for <b>1 speed</b> chainwheel sets</li> <li>mounting at the <b>seat tube</b> Ø 34.9 mm (incl. adapter for 31.8 mm)</li> <li>made of high quality <b>nylon</b> and <b>glass fibre</b></li> <li><b>aluminium</b> clamp</li> <li>height adjustment: 15 mm</li> <li>only 77 g (without adapter)</li> <li>on M-Wave eurohole card</li> </ul> <p>UVP 31,90 €</p>	 
<p><b>303309</b></p> <p>150</p>	<p><b>KETTENSPANNER</b></p> <ul style="list-style-type: none"> <li>für Single-Speed, Fixies, BMX, ...</li> <li>aus <b>Aluminium</b></li> <li>schwarz</li> <li>Armlänge ca. 68 mm</li> <li>Montageverpackung</li> </ul>	<p><b>CHAIN ADJUSTER</b></p> <ul style="list-style-type: none"> <li>for single speed, fixies, BMX, ...</li> <li>made of <b>aluminium</b></li> <li>black</li> <li>arm length approx. 68 mm</li> <li>OEM</li> </ul> <p>UVP 19,90 €</p>	
<p><b>303313</b></p> <p>1.000/100</p>	<p><b>KETTENSPANNER</b></p> <ul style="list-style-type: none"> <li>mit Mutter</li> <li>SW 10 x 6 mm</li> <li>Loch Ø 11,2 mm</li> <li>57 mm lang</li> </ul>	<p><b>CHAIN ADJUSTER</b></p> <ul style="list-style-type: none"> <li>with nut</li> <li>SW 10 x 6 mm</li> <li>hole Ø 11.2 mm</li> <li>57 mm long</li> </ul> <p>UVP 35,90 €/100</p>	
<p><b>300180</b></p> <p>für <b>31,8 mm</b> Sitzrohre</p> <p><b>300181</b></p> <p>für <b>34,9 mm</b> Sitzrohre</p> <p>200</p>	<p><b>KETTENABWEISER</b></p> <ul style="list-style-type: none"> <li><b>verhindert</b> das Herabfallen und <b>Verklemmen der Kette</b></li> <li>aus Kunststoff</li> <li>auf M-Wave Eurolochkarte</li> </ul>	<p><b>CHAIN DEFLECTOR</b></p> <ul style="list-style-type: none"> <li><b>prevents chain</b> from <b>falling down</b> and <b>jamming</b></li> <li>made of plastic</li> <li>on M-Wave eurohole card</li> </ul> <p>UVP 4,90 €</p>	  











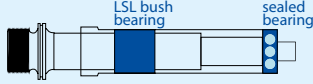





ART.-NR. 	BESCHREIBUNG	DESCRIPTION	
<b>303312</b> 500 pair	<b>UNIVERSAL-SCHUTZFOLIE &gt;PROTECTO CUT-TO-FIT&lt;</b> <ul style="list-style-type: none"> <li>• <b>individuell zuschneidbar</b></li> <li>• selbstklebend</li> <li>• <b>geräuschkämmend</b></li> <li>• <b>leicht formbar</b></li> <li>• Größe: ca. <b>400 x 90 mm</b></li> <li>• für Unterrohr, Motorenhäuse, Kettenstrebe, ...</li> <li>• Material: <b>PU</b></li> <li>• schwarz</li> <li>• im Polybeutel mit M-Wave Euroloch-header</li> </ul>	<b>UNIVERSAL PROTECTION &gt;PROTECTO CUT-TO-FIT&lt;</b> <ul style="list-style-type: none"> <li>• <b>individually cut to size</b></li> <li>• self-adhesive</li> <li>• <b>noise absorbing</b></li> <li>• <b>easy to shape</b></li> <li>• size: approx. <b>400 x 90 mm</b></li> <li>• for down tube, motor cover, chain stay, ...</li> <li>• material: <b>PU</b></li> <li>• black</li> <li>• in PE bag with M-Wave eurohole header</li> </ul>	     <p style="text-align: right;">UVP 9,90 €</p>
<b>303350</b> 100 set	<b>SCHUTZFOLIEN-SET</b> <ul style="list-style-type: none"> <li>• zum <b>Schutz für Rahmen, Gabel, ...</b></li> <li>• transparent</li> <li>• <b>selbstklebendes</b> Material von <b>3M Scotchlite</b></li> <li>• 1 Set = 1 x Kettenstrebenschutz, 4 x Ø 20 mm und 4 x Ø 30 mm</li> <li>• auf Velo Eurolockkarte</li> </ul>	<b>PROTECTION STICKER SET</b> <ul style="list-style-type: none"> <li>• <b>protection for frame, fork, ...</b></li> <li>• transparent</li> <li>• <b>self-adhesive</b> material from <b>3M Scotchlite</b></li> <li>• 1 set = 1 x chain stay protector, 4 x Ø 20 mm and 4 x Ø 30 mm</li> <li>• on Velo eurohole card</li> </ul>	   <p style="text-align: right;">UVP 9,90 €</p>
<b>303351</b> 100 set	<b>SCHUTZFOLIEN-SET XL</b> <ul style="list-style-type: none"> <li>• passend für die meisten Rahmen</li> <li>• <b>universell zuschneidbarer</b> Schutz</li> <li>• <b>selbstklebend</b>, transparent</li> <li>• bestehend aus:             <ul style="list-style-type: none"> <li>1 Stk. 500 x 55 mm</li> <li>1 Stk. 260 x 35 mm</li> <li>6 Stk. 35 x 35 mm</li> </ul> </li> <li>• im Polybeutel mit M-Wave Euroloch-header</li> </ul>	<b>PROTECTION FOIL SET XL</b> <ul style="list-style-type: none"> <li>• suitable for the most frames</li> <li>• <b>universally cuttable</b> protection</li> <li>• <b>selfadhesive</b>, transparent</li> <li>• consisting of:             <ul style="list-style-type: none"> <li>1 pc 500 x 55 mm</li> <li>1 pc 260 x 35 mm</li> <li>6 pcs 35 x 35 mm</li> </ul> </li> <li>• in PE bag with M-Wave eurohole header</li> </ul>	    <p style="text-align: right;">UVP 5,90 €</p>
<b>610006</b> 500/100	<b>KETTENSTREBENSCHUTZ FÜR E-FULLY</b> <ul style="list-style-type: none"> <li>• Material: <b>Silikonkautschuk</b></li> <li>• Größe: ca. <b>316 x 52 x 47 mm</b></li> <li>• Montageverpackung</li> </ul>	<b>CHAINSTAY PROTECTION FOR E-FULLY</b> <ul style="list-style-type: none"> <li>• material: <b>silicone rubber</b></li> <li>• size: approx. <b>316 x 52 x 47 mm</b></li> <li>• OEM</li> </ul>	  <p style="text-align: right;">UVP 6,90 €</p>



















ART.-NR. 	BESCHREIBUNG	DESCRIPTION	
<b>303331</b> 300/25	<b>KETTENSTREBENSCHUTZ</b> <ul style="list-style-type: none"> <li>aus schwarzem <b>Lycra/Neopren</b></li> <li><b>extra dickes Kettenprofil</b></li> <li><b>Non-Slip Innenseite</b></li> <li>Größe: 245 x (95 - 110) mm</li> <li>im Polybeutel mit Velo Eurolochheader</li> </ul>	<b>CHAIN STAY PROTECTOR</b> <ul style="list-style-type: none"> <li>made of black <b>Lycra/neoprene</b></li> <li><b>extra thick chain profile</b></li> <li><b>non-slip layer inside</b></li> <li>size: 245 x (95 - 110) mm</li> <li>in PE bag with Velo eurohole header</li> </ul>	<p style="text-align: right;">UVP 7,90 €</p>
<b>303332</b> 400/25	<b>KETTENSTREBENSCHUTZ</b> <ul style="list-style-type: none"> <li>aus schwarzem <b>Lycra/Neopren</b></li> <li>im Polybeutel mit Velo Eurolochheader</li> </ul> <p><b>extra breit:</b> ca. 260 x (100 - 130) mm für voluminöse Kettenstreben</p>	<b>CHAIN STAY PROTECTOR</b> <ul style="list-style-type: none"> <li>made of black <b>Lycra/neoprene</b></li> <li>in PE bag with Velo eurohole header</li> </ul> <p><b>extra wide:</b> approx. 260 x (100 - 130) mm for big chain stays</p>	<div style="border: 1px solid blue; padding: 2px; display: inline-block;"><b>XL</b></div> <p style="text-align: right;">UVP 5,90 €</p>
<b>303322</b> 400/25	<p>Größe: 260 x (95 - 110) mm</p>	<p>size: 260 x (95 - 110) mm</p>	<p style="text-align: right;">UVP 4,90 €</p>
<b>303333</b> 250	<b>KETTENSTREBENSCHUTZ ›PROTECTO XL‹</b> <ul style="list-style-type: none"> <li>schwarzes Neopren</li> <li>Größe: 260 x (100 - 130) mm</li> <li>im Polybeutel mit M-Wave Eurolochheader</li> </ul>	<b>CHAIN STAY PROTECTOR ›PROTECTO XL‹</b> <ul style="list-style-type: none"> <li>black neoprene</li> <li>size: 260 x (100 - 130) mm</li> <li>in PE bag with M-Wave eurohole header</li> </ul>	<div style="border: 1px solid blue; padding: 2px; display: inline-block;"><b>XL</b></div> <p style="text-align: right;">UVP 3,90 €</p>











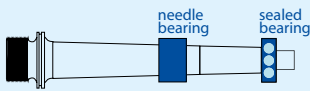



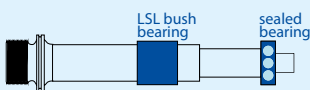













# PEDALS











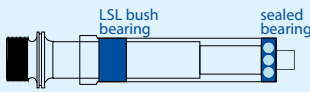







ART.-NR.	BESCHREIBUNG	DESCRIPTION	
<p><b>311855</b></p> <p>30 pair</p>	<p><b>KLICKPEDAL ›E-PR200CKTI‹</b></p> <ul style="list-style-type: none"> <li>• <b>carbonfaserverstärkter Körper</b></li> <li>• <b>gedichtete, CNC-gefräste, E-PA5TI Titanium-Achse</b> (Art. 311869)</li> <li>• mit <b>gedichtetem Industriekugellager</b> (Art. 311878) und <b>hochwertigem Gleitlager</b></li> <li>• nur <b>176 g/Pair</b></li> <li>• mit <b>Anti-Rutsch</b> EPS-R Schuhplatten-set (7° drehbar)</li> <li>• große Auflagefläche für hohen Komfort und optimale Kraftübertragung</li> <li>• kompatibel zum <b>Look Keo</b> System (kein original Look Ersatzteil)</li> <li>• max. Fahrgewicht 85 kg</li> <li>• in Exustar Einzelkarton</li> </ul>	<p><b>CLIPLESS PEDAL ›E-PR200CKTI‹</b></p> <ul style="list-style-type: none"> <li>• <b>injected carbon fiber body</b></li> <li>• <b>sealed, CNC machined E-PA5TI titanium axle</b> (art. 311869)</li> <li>• with <b>sealed bearing</b> (art. 311878) and <b>high quality bush bearing</b></li> <li>• only <b>176 g/pair</b></li> <li>• with <b>non-slip</b> EPS-R cleat set (7° turnable)</li> <li>• large pedalling area for high comfort and great pedalling efficiency</li> <li>• compatible with <b>Look Keo</b> system (no original Look spare part)</li> <li>• max. rider weight 85 kg</li> <li>• in Exustar box</li> </ul>  <p>Tested by the manufacturer based on ISO 4210</p> <p>UVP 269,00 €</p>	<p><b>EXUSTAR</b></p>  <p><b>176 g</b></p> <p><b>THE WORLD'S LIGHTEST WITH CARTRIDGE BEARING</b></p> <p><i>"Die besten Pedale, die ich je gefahren bin!"</i> Marcel Wüst, 2018</p>    <p>Art. 311878</p>  
<p><b>311869</b></p> <p>10 pair</p>	<p><b>CARTRIDGE PEDALACHSE</b></p> <ul style="list-style-type: none"> <li>• <b>gedichtete, CNC-gefräste Titanium-Achse</b></li> <li>• mit <b>gedichtetem Industriekugellager</b> (Art. 311878) und <b>hochwertigem Gleitlager</b></li> <li>• <b>Ersatz-Achse</b> für Exustar-Pedal Art. 311855</li> <li>• <b>Tuning-Achse</b> für Art. 311853</li> <li>• nur <b>42 g</b></li> <li>• sehr einfach austauschbar</li> <li>• 1 Paar im Polybeutel mit Exustar Eurolochheader</li> </ul>	<p><b>CARTRIDGE PEDAL AXLE</b></p> <ul style="list-style-type: none"> <li>• <b>sealed, CNC machined titanium axle</b></li> <li>• with <b>sealed bearing</b> (art. 311878) and <b>high quality bush bearing</b></li> <li>• <b>replacement axle</b> for Exustar pedal art. 311855</li> <li>• <b>tuning axle</b> for art. 311853</li> <li>• only <b>42 g</b></li> <li>• very easy to replace</li> <li>• 1 pair in PE bag with Exustar eurohole header</li> </ul>  <p><b>42 g</b></p>    <p><b>TITANIUM</b></p> <p>UVP 137,00 €</p>	
<p><b>311853</b></p> <p>30 pair</p>	<p><b>KLICKPEDAL ›E-PR200BK‹</b></p> <ul style="list-style-type: none"> <li>• <b>Thermokunststoff-Körper</b></li> <li>• <b>gedichtete, CNC-gefräste CrMo-Achse</b></li> <li>• mit <b>gedichtetem Industriekugellager</b> und <b>hochwertigem Gleitlager</b></li> <li>• nur <b>244 g/Pair</b></li> <li>• E-ARC 11 <b>Non-Slip</b> Schuhplatten-set (7° drehbar) mit großer Auflagefläche für hohen Komfort und optimale Kraftübertragung</li> <li>• kompatibel zum <b>Look Keo</b> System (kein original Look Ersatzteil)</li> <li>• in Exustar Einzelkarton</li> </ul>	<p><b>CLIPLESS PEDAL ›E-PR200BK‹</b></p> <ul style="list-style-type: none"> <li>• <b>thermoplastic body</b></li> <li>• <b>sealed, CNC machined CrMo axle</b></li> <li>• with <b>sealed bearing</b> and <b>high quality bush bearing</b></li> <li>• only <b>244 g/pair</b></li> <li>• E-ARC 11 <b>non-slip</b> cleat set (7° turnable) with large pedalling area for high comfort and great pedalling efficiency</li> <li>• compatible with <b>Look Keo</b> system (no original Look spare part)</li> <li>• in Exustar box</li> </ul>  <p>Tested by the manufacturer based on ISO 4210</p> <p>UVP 78,90 €</p>	<p><b>EXUSTAR</b></p>  <p><b>244 g</b></p>    









ART.-NR. 	BESCHREIBUNG	DESCRIPTION	
<b>311872</b> 30 pair	<b>KLICKPEDAL ›E-PR103P‹</b> <ul style="list-style-type: none"> <li>• Thermokunststoff-Körper</li> <li>• gedichtete, CNC-gefräste CrMo-Achse</li> <li>• mit gedichtetem Industriekugellager und hochwertigem Gleitlager</li> <li>• nur 270 g/Pair</li> <li>• verbesserter Einstellmechanismus mit <b>Federspannungsindikator</b></li> <li>• mit E-ARC 10 Schuhplattenset (7° drehbar)</li> <li>• <b>große Auflagefläche</b> für hohen Komfort und optimale Kraftübertragung</li> <li>• kompatibel zum <b>Look Keo</b> System (kein original Look Ersatzteil)</li> <li>• in Exustar Einzelkarton</li> </ul>	<b>CLIPLESS PEDAL ›E-PR103P‹</b> <ul style="list-style-type: none"> <li>• thermoplastic body</li> <li>• sealed, CNC machined CrMo axle</li> <li>• with sealed bearing and high quality bush bearing</li> <li>• only 270 g/pair</li> <li>• improved adjustment mechanism with <b>spring tension indicator</b></li> <li>• with E-ARC 10 cleat set (7° turnable)</li> <li>• <b>large pedalling area</b> for high comfort and great pedalling efficiency</li> <li>• compatible with <b>Look Keo</b> system (no original Look spare part)</li> <li>• in Exustar box</li> </ul> <div style="text-align: center;">  <p>Tested by the manufacturer based on ISO 4210</p> <p>UVP 69,90 €</p> </div>	     
<b>313451</b> 40 pair 	<b>KLICKPEDAL ›DRAG-R1‹</b> <ul style="list-style-type: none"> <li>• Aluminiumkörper</li> <li>• CrMo-Achse</li> <li>• mit gedichteten Kugellagern</li> <li>• große Auflagefläche für hohen Komfort und optimale Kraftübertragung</li> <li>• kompatibel zum <b>Look Keo</b> System (kein original Look Ersatzteil)</li> <li>• mit Schuhplattenset, <b>9° drehbar</b></li> <li>• nur 327 g/Pair</li> <li>• auf M-Wave Eurolochkarte</li> </ul>	<b>CLIPLESS PEDAL ›DRAG-R1‹</b> <ul style="list-style-type: none"> <li>• aluminium body</li> <li>• CrMo axle</li> <li>• with sealed bearings</li> <li>• large pedalling area for high comfort and great pedalling efficiency</li> <li>• compatible with <b>Look Keo</b> system (no original Look spare part)</li> <li>• with cleat set, <b>9° turnable</b></li> <li>• only 327 g/pair</li> <li>• on M-Wave eurohole card</li> </ul> <div style="text-align: center;">  <p>UVP 33,90 €</p> </div>	    
<b>587839</b> 20 pair	<b>KLICKPEDAL ›PD-RS 500‹</b> <ul style="list-style-type: none"> <li>• mit Schuhplattenset</li> <li>• leichter Ein- und Ausstieg</li> <li>• Auslösehärte einstellbar</li> <li>• gedichtetes Kompaktlager</li> <li>• nur 320 g/Pair</li> <li>• in Shimano Eurolochbox</li> </ul>	<b>CLIPLESS PEDAL ›PD-RS 500‹</b> <ul style="list-style-type: none"> <li>• with cleat set</li> <li>• easy click-in and click-out</li> <li>• adjustable release tension</li> <li>• sealed compact bearing</li> <li>• only 320 g/pair</li> <li>• in Shimano eurohole box</li> </ul>	  

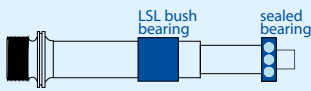
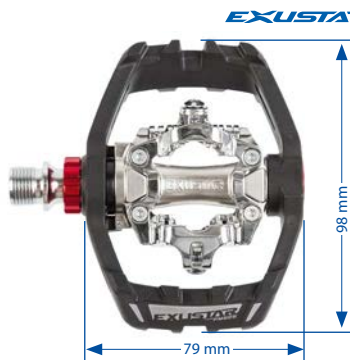

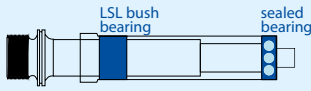
ART.-NR.	BESCHREIBUNG	DESCRIPTION	
<b>311864</b> 30 pair	<b>KLICKPEDAL ›E-PM222TI‹</b> <ul style="list-style-type: none"> <li>• CNC-gefräster Aluminiumkörper</li> <li>• hervorragende <b>Haltbarkeit</b> durch austauschbare <b>Stahl-Schutzauflagen</b></li> <li>• gedichtete, <b>massive CNC-gefräste 6A4V-Titanium-Achse</b></li> <li>• <b>sehr leichter Lauf</b> und <b>hohe Verschleißfestigkeit</b></li> <li>• mit <b>gedichtetem Industriekugellager</b> (Art. 311878) und <b>selbstschmierenden Nadellager</b></li> <li>• sehr gute Einstellbarkeit <b>der Auslösehärte</b> durch <b>CrMo-Klickmechanismus</b></li> <li>• nur <b>259 g/Pair</b></li> <li>• mit austauschbarer Staubkappe (Art. 311879)</li> <li>• max. Fahrergewicht 85 kg</li> <li>• mit Schuhplattenset</li> <li>• kompatibel zum <b>Shimano System</b> (kein original Shimano Ersatzteil)</li> <li>• in Exustar Einzelkarton</li> </ul>	<b>CLIPLESS PEDAL ›E-PM222TI‹</b> <ul style="list-style-type: none"> <li>• CNC machined aluminium body</li> <li>• excellent <b>durability</b> through exchangeable <b>steel protection inlays</b></li> <li>• sealed, <b>massive CNC machined 6A4V titanium axle</b></li> <li>• <b>very easy rotation</b> and <b>high wear resistance</b></li> <li>• with <b>sealed bearing</b> (art. 311878) and <b>self lubricating</b> needle bearing</li> <li>• very good adjustability of the <b>release tension</b> through <b>CrMo click mechanism</b></li> <li>• only <b>259 g/pair</b></li> <li>• with replaceable dust cap (art. 311879)</li> <li>• max. rider weight 85 kg</li> <li>• with cleat set</li> <li>• compatible with <b>Shimano system</b> (no original Shimano spare part)</li> <li>• in Exustar box</li> </ul>  <p>Tested by the manufacturer based on ISO 4210</p> <p>UVP 219,00 €</p>	 <p><b>EXUSTAR</b></p> <p><b>STEEL STRENGTHENING</b></p> <p><b>MASSIVE TITANIUM</b></p>   
<b>311804</b> 30 pair	<b>KLICKPEDAL ›E-PM215+TI‹</b> <ul style="list-style-type: none"> <li>• geschmiedeter <b>Aluminiumkörper</b></li> <li>• sehr leichter Lauf durch <b>gedichtete, CNC-gefräste, 6A4V-Titanium-Achse</b></li> <li>• mit <b>gedichtetem Industriekugellager</b> (Art. 311878) und <b>hochwertigem Gleitlager</b></li> <li>• mit <b>Stahl-Klickmechanismus</b></li> <li>• nur <b>246 g/Pair</b></li> <li>• mit austauschbarer Staubkappe (Art. 311879)</li> <li>• max. Fahrergewicht 85 kg</li> <li>• mit Schuhplattenset</li> <li>• kompatibel zum <b>Shimano System</b> (kein original Shimano Ersatzteil)</li> <li>• in Exustar Einzelkarton</li> </ul>	<b>CLIPLESS PEDAL ›E-PM215+TI‹</b> <ul style="list-style-type: none"> <li>• forged <b>aluminium</b> body</li> <li>• very easy rotation by <b>sealed, CNC machined, 6A4V titanium axle</b></li> <li>• with <b>sealed bearing</b> (art. 311878) and <b>high quality bush bearing</b></li> <li>• with steel click mechanism</li> <li>• only <b>246 g/pair</b></li> <li>• with replaceable dust cap (art. 311879)</li> <li>• max. rider weight 85 kg</li> <li>• with cleat set</li> <li>• compatible with <b>Shimano system</b> (no original Shimano spare part)</li> <li>• in Exustar box</li> </ul>  <p>Tested by the manufacturer based on ISO 4210</p> <p>UVP 195,00 €</p>	 <p><b>EXUSTAR</b></p> <p><b>TITANIUM</b></p>   
<b>587693</b> 20 pair	<b>MTB PEDAL ›PD-M520L‹</b> <ul style="list-style-type: none"> <li>• CrMo Achse</li> <li>• Auslösehärte einstellbar</li> <li>• gedichtetes Kompaktlager</li> <li>• nur 380 g/Pair</li> <li>• in Shimano Eurolochbox</li> </ul>	<b>MTB PEDAL ›PD-M520L‹</b> <ul style="list-style-type: none"> <li>• CrMo axle</li> <li>• adjustable release tension</li> <li>• sealed compact bearing</li> <li>• only 380 g/pair</li> <li>• in Shimano eurohole box</li> </ul> <p>UVP 88,90 €</p>	<p><b>SHIMANO</b></p>  



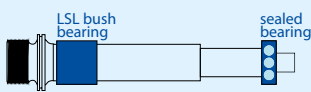

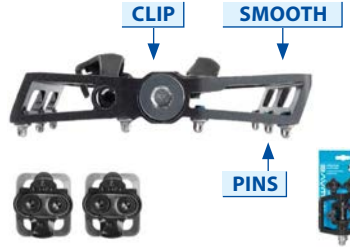





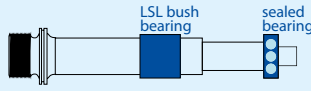



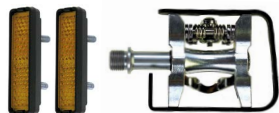

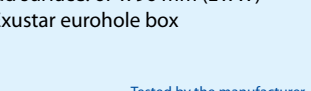
ART.-NR. 	BESCHREIBUNG	DESCRIPTION	
<b>311847</b> 30 pair	<b>KLICKPEDAL ›E-PM215+‹</b> <ul style="list-style-type: none"> <li>geschmiedeter <b>Aluminiumkörper</b></li> <li><b>gedichtete, CNC-gefräste CrMo-Achse</b></li> <li>mit <b>gedichtetem Industriekugellager</b> und <b>hochwertigem Gleitlager</b></li> <li>mit Stahl-Klickmechanismus</li> <li>nur <b>300 g/Pair</b></li> <li>mit austauschbarer Staubkappe (Art. 311879)</li> <li>mit Schuhplattenset</li> <li>kompatibel zum <b>Shimano System</b> (kein original Shimano Ersatzteil)</li> <li>in Exustar Einzelkarton</li> </ul>	<b>CLIPLESS PEDAL ›E-PM215+‹</b> <ul style="list-style-type: none"> <li>forged <b>aluminium body</b></li> <li><b>sealed, CNC machined CrMo axle</b></li> <li>with <b>sealed bearing</b> and <b>high quality bush bearing</b></li> <li>with steel click mechanism</li> <li>only <b>300 g/pair</b></li> <li>with replaceable dust cap (art. 311879)</li> <li>with cleat set</li> <li>compatible with <b>Shimano system</b> (no original Shimano spare part)</li> <li>in Exustar box</li> </ul> <div style="text-align: center;">  <p>Tested by the manufacturer based on ISO 4210</p> </div> <p style="text-align: right;">UVP 76,90 €</p>	<div style="text-align: right;"><b>EXUSTAR</b></div> <div style="text-align: center;">  </div> <div style="text-align: center;">  </div> <div style="display: flex; justify-content: space-around; align-items: center;">   </div>
<b>311852</b> 30 pair	<b>KLICKPEDAL ›E-PR50‹</b> <ul style="list-style-type: none"> <li><b>extrudierter, CNC-gefräster Aluminiumkörper</b></li> <li><b>gehärtete, CNC-gefräste CrMo-Achse</b></li> <li>mit <b>gedichtetem Industriekugellager</b> und <b>hochwertigem Gleitlager</b></li> <li>nur <b>262 g/Pair</b></li> <li><b>große Auflagefläche</b> für hohen Komfort und optimale Kraftübertragung</li> <li>Käfig <b>schützt</b> Klickmechanismus</li> <li>mit Schuhplattenset</li> <li>kompatibel zum <b>Shimano System</b> (kein original Shimano Ersatzteil)</li> <li>in Exustar Einzelkarton</li> </ul>	<b>CLIPLESS PEDAL ›E-PR50‹</b> <ul style="list-style-type: none"> <li><b>extruded, CNC machined aluminium body</b></li> <li><b>hardened, CNC machined CrMo axle</b></li> <li>with <b>sealed bearing</b> and <b>high quality bush bearing</b></li> <li>only <b>262 g/pair</b></li> <li><b>large pedalling area</b> for high comfort and great pedalling efficiency</li> <li>cage <b>protects</b> click mechanism</li> <li>with cleat set</li> <li>compatible with <b>Shimano system</b> (no original Shimano spare part)</li> <li>in Exustar box</li> </ul> <div style="text-align: center;">  <p>Tested by the manufacturer based on ISO 4210</p> </div> <p style="text-align: right;">UVP 84,90 €</p>	<div style="text-align: right;"><b>EXUSTAR</b></div> <div style="text-align: center;">  </div> <div style="text-align: center;">  </div> <div style="display: flex; justify-content: space-around; align-items: center;">   </div>
<b>311849</b> 30 pair	<b>KLICKPEDAL ›E-PM211‹</b> <ul style="list-style-type: none"> <li><b>Aluminiumkörper</b></li> <li><b>silberne, gedichtete CrMo-Achse</b></li> <li>mit <b>gedichteten Industriekugellagern</b></li> <li>nur <b>360 g/Pair</b></li> <li>mit Schuhplattenset (auch passend für <b>Shimano Pedale</b>)</li> <li>mit Schuhplattenset</li> <li>kompatibel zum <b>Shimano System</b> (kein original Shimano Ersatzteil)</li> <li>in Exustar Einzelkarton</li> </ul>	<b>CLIPLESS PEDAL ›E-PM211‹</b> <ul style="list-style-type: none"> <li><b>aluminium body</b></li> <li><b>silver, sealed CrMo axle</b></li> <li>with <b>sealed bearings</b></li> <li>only <b>360 g/pair</b></li> <li>with cleat set (also suitable for <b>Shimano pedals</b>)</li> <li>with cleat set</li> <li>compatible with <b>Shimano system</b> (no original Shimano spare part)</li> <li>in Exustar box</li> </ul> <div style="text-align: center;">  <p>Tested by the manufacturer based on ISO 4210</p> </div> <p style="text-align: right;">UVP 52,90 €</p>	<div style="text-align: right;"><b>EXUSTAR</b></div> <div style="text-align: center;">  </div> <div style="text-align: center;">  </div> <div style="display: flex; justify-content: space-around; align-items: center;">   </div>

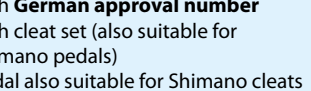

ART.-NR.	BESCHREIBUNG	DESCRIPTION	
<p><b>312062</b></p> <p>30 pair</p>  <p><b>TIP</b></p>	<p><b>KLICKPEDAL ›DRAG-R2‹</b></p> <ul style="list-style-type: none"> <li>• <b>Aluminiumkörper</b></li> <li>• <b>CrMo-Achse</b></li> <li>• mit <b>gedichtetem Industriekugellager</b> und <b>hochwertigem Gleitlager</b></li> <li>• Montage auch mit Innensechskantschlüssel möglich</li> <li>• Käfig schützt Klickmechanismus</li> <li>• nur <b>284 g/Pair</b></li> <li>• mit Schuhplattenset</li> <li>• kompatibel zum <b>Shimano</b> System (kein original Shimano Ersatzteil)</li> <li>• auf M-Wave Eurolochkarte</li> </ul>	<p><b>CLIPLESS PEDAL ›DRAG-R2‹</b></p> <ul style="list-style-type: none"> <li>• <b>aluminium body</b></li> <li>• <b>CrMo axle</b></li> <li>• with <b>sealed bearing</b> and <b>high quality bush bearing</b></li> <li>• mounting also possible with allen key</li> <li>• cage protects click mechanism</li> <li>• only <b>284 g/pair</b></li> <li>• with cleat set</li> <li>• compatible with <b>Shimano</b> system (no original Shimano spare part)</li> <li>• on M-Wave eurohole card</li> </ul>  <p>Tested by the manufacturer based on ISO 4210</p> <p>UVP 43,90 €</p>	      
<p><b>310051</b></p> <p>100 pair</p>	<p><b>PLATTFORM FÜR SYSTEMPEDALE ›TRANSFORMER A‹</b></p> <ul style="list-style-type: none"> <li>• <b>verwandelt Klickpedale in Plattformpedale</b></li> <li>• passend für <b>SPD, Look Keo, ...</b> Schuhplatten (kein original Shimano, Look Ersatzteil)</li> <li>• mit je <b>12 austauschbaren Aluminium-Pins</b></li> <li>• 85 x 90 mm</li> <li>• Aluminium</li> <li>• nur <b>38 g/Stk.</b></li> <li>• auf M-Wave Eurolochkarte</li> </ul>	<p><b>PLATFORM FOR SYSTEM PEDALS ›TRANSFORMER A‹</b></p> <ul style="list-style-type: none"> <li>• <b>changes clipless pedals to platform pedals</b></li> <li>• suitable for <b>SPD, Look Keo, ...</b> cleats (no original Shimano, Look spare part)</li> <li>• with <b>12 exchangeable aluminium pins</b> each</li> <li>• 85 x 90 mm</li> <li>• aluminium</li> <li>• only <b>38 g/pcs.</b></li> <li>• on M-Wave eurohole card</li> </ul>	    
<p><b>310050</b></p> <p>80/20 pair</p> <p><b>NICE PRICE</b></p>	<p><b>PLATTFORM FÜR KLICKPEDALE ›TRANSFORMER‹</b></p> <ul style="list-style-type: none"> <li>• <b>verwandelt Klickpedale in Plattformpedale</b></li> <li>• <b>SPD-kompatibel</b></li> <li>• mit Reflektoren</li> <li>• inkl. <b>Schuhplatten-Set aus Metall</b></li> <li>• 73 x 77 mm (L x B)</li> <li>• auf M-Wave Eurolochkarte</li> </ul>	<p><b>PLATFORM FOR CLIPLESS PEDALS ›TRANSFORMER‹</b></p> <ul style="list-style-type: none"> <li>• <b>changes click pedals to platform pedals</b></li> <li>• <b>SPD compatible</b></li> <li>• with reflectors</li> <li>• incl. <b>metal cleat set</b></li> <li>• 73 x 77 mm (L x W)</li> <li>• on M-Wave eurohole card</li> </ul>	    

ART.-NR. 	BESCHREIBUNG	DESCRIPTION	
<b>311866</b> 30 pair	<b>PLATTFORM-KLICKPEDAL ›E-PM825‹</b> <ul style="list-style-type: none"> <li>• Aluminiumkörper mit Kunststoff-plattform</li> <li>• mit Schnelleinstiegs-Funktion durch Popup-Bindung</li> <li>• mit gedichtetem Industriekugellager und hochwertigem Gleitlager</li> <li>• CNC gefräste CrMo-Achse (9/16")</li> <li>• nur 460 g/Pair</li> <li>• mit Schuhplattenset</li> <li>• kompatibel zum Shimano System (kein original Shimano Ersatzteil)</li> <li>• Trittfläche: ca. 98 x 79 mm (L x B)</li> <li>• in Exustar Eurolochbox</li> </ul>	<b>PLATFORM CLIPLESS PEDAL ›E-PM825‹</b> <ul style="list-style-type: none"> <li>• aluminium body with plastic platform</li> <li>• with easy entry function through popup binding</li> <li>• with sealed bearing and high quality bush bearing</li> <li>• CNC machined CrMo axle (9/16")</li> <li>• only 460 g/pair</li> <li>• with cleat set</li> <li>• compatible with Shimano system (no original Shimano spare part)</li> <li>• tread surface: approx. 98 x 79 mm (L x W)</li> <li>• in Exustar eurohole box</li> </ul>  <p>Tested by the manufacturer based on ISO 4210</p> <p>UVP 96,90 €</p>	 <p>EXUSTAR</p> <p>98 mm</p> <p>79 mm</p> 
<b>311867</b> 30 pair	<b>PLATTFORM-KOMBIPEDAL ›E-PM827‹</b> <ul style="list-style-type: none"> <li>• besonders flacher (18 mm), CNC-gefräster Aluminiumkörper</li> <li>• austauschbare, CNC-gefräste CrMo-Achse (9/16")</li> <li>• mit gedichtetem Industriekugellager und hochwertigem Gleitlager</li> <li>• nur 397 g/Pair</li> <li>• mit Schuhplattenset</li> <li>• kompatibel zum Shimano System (kein original Shimano Ersatzteil)</li> <li>• mit austauschbaren Pins und zwei Ersatzpins</li> <li>• Trittfläche: ca. 100 x 100 mm (L x B)</li> <li>• in Exustar Eurolochbox</li> </ul>	<b>PLATFORM COMBINATION PEDAL ›E-PM827‹</b> <ul style="list-style-type: none"> <li>• especially flat (18 mm), CNC machined aluminium body</li> <li>• changable, CNC machined CrMo axle (9/16")</li> <li>• with sealed bearing and high quality bush bearing</li> <li>• only 397 g/pair</li> <li>• with cleat set</li> <li>• compatible with Shimano system (no original Shimano spare part)</li> <li>• with exchangeable pins and two replacement pins</li> <li>• tread surface: approx. 100 x 100 mm (L x W)</li> <li>• in Exustar eurohole box</li> </ul>  <p>Tested by the manufacturer based on ISO 4210</p> <p>UVP 105,00 €</p>	 <p>EXUSTAR</p> <p>18 mm</p> 
<b>312150</b> 30 pair 	<b>PLATTFORM-KOMBIPEDAL ›FREEDOM CLIPLESS‹</b> <ul style="list-style-type: none"> <li>• CNC-gefräster Aluminiumkörper</li> <li>• CrMo-Achse</li> <li>• mit gedichtetem Industriekugellager und hochwertigem Gleitlager</li> <li>• Montage auch mit Innensechskant möglich</li> <li>• mit Schuhplattenset</li> <li>• kompatibel zum Shimano System (kein original Shimano Ersatzteil)</li> <li>• mit austauschbaren Pins auf einer Seite</li> <li>• Trittfläche: ca. 92 x 102 mm (L x B)</li> <li>• nur 437 g</li> <li>• auf M-Wave Eurolochkarte</li> </ul>	<b>PLATFORM COMBINATION PEDAL ›FREEDOM CLIPLESS‹</b> <ul style="list-style-type: none"> <li>• CNC machined aluminium body</li> <li>• CrMo axle</li> <li>• with sealed bearing and high quality bush bearing</li> <li>• mounting also possible with allen key</li> <li>• with cleat set</li> <li>• compatible with Shimano system (no original Shimano spare part)</li> <li>• with exchangeable pins at one side</li> <li>• tread surface: approx. 92 x 102 mm (L x W)</li> <li>• only 437 g</li> <li>• on M-Wave eurohole card</li> </ul>  <p>Tested by the manufacturer based on ISO 4210</p> <p>UVP 59,90 €</p>	 <p>M-WAVE</p> <p>CLIP</p> <p>SMOOTH</p> <p>PINS</p> 

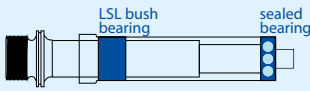
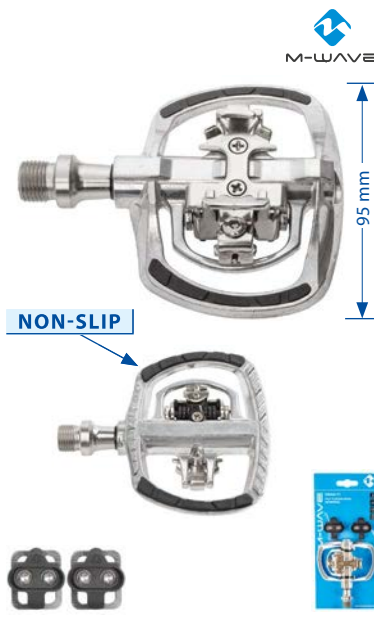

ART.-NR.	BESCHREIBUNG	DESCRIPTION	
<p><b>311861</b> 30 pair</p>	<p><b>PLATTFORM-KOMBIPEDAL</b> »E-PM820-2«</p> <ul style="list-style-type: none"> <li>• <b>Aluminiumkörper</b></li> <li>• umrüstbar auf Klick oder Halb-Klick mit <b>SPD-kompatiblen Nachrüst-Klicksystem</b> (Art. 311862)</li> <li>• <b>gedichtete CNC-gefräste CrMo-Achse</b> (9/16")</li> <li>• mit <b>gedichtetem Industriekugellager</b> und <b>hochwertigem Gleitlager</b></li> <li>• mit <b>austauschbaren</b> Pins</li> <li>• nur 423 g/Pair</li> <li>• Trittfläche: 109 x 105 mm (L x B)</li> <li>• in Exustar Eurolochbox</li> </ul>	<p><b>PLATFORM COMBINATION PEDAL</b> »E-PM820-2«</p> <ul style="list-style-type: none"> <li>• <b>aluminium</b> body</li> <li>• changeable to clipless or half click pedals with <b>SPD compatible add-on kit</b> (art. 311862)</li> <li>• <b>sealed CNC machined CrMo axle</b> (9/16")</li> <li>• with <b>sealed bearing</b> and <b>high quality bush bearing</b></li> <li>• with <b>exchangeable</b> pins</li> <li>• only 423 g/pair</li> <li>• tread surface: 109 x 105 mm (L xW)</li> <li>• in Exustar eurohole box</li> </ul> <div data-bbox="624 734 935 817" data-label="Diagram"> </div> <div data-bbox="746 840 935 878" data-label="Text"> <p>Tested by the manufacturer based on ISO 4210</p> </div> <div data-bbox="837 898 935 920" data-label="Text"> <p>UVP 52,90 €</p> </div>	<p><b>EXUSTAR</b></p> <div data-bbox="965 280 1220 459" data-label="List-Group"> <p>3 IN 1</p> <ul style="list-style-type: none"> <li><input checked="" type="checkbox"/> BMX + MTB</li> <li><input checked="" type="checkbox"/> 1 SIDE CLIPLESS</li> <li><input checked="" type="checkbox"/> 2 SIDE CLIPLESS</li> </ul> </div> <div data-bbox="965 470 1340 918" data-label="Image"> </div>
<p><b>311862</b> 100 pair</p>	<p><b>KLICKSYSTEM</b> »E-EMM276«</p> <ul style="list-style-type: none"> <li>• zum Umrüsten von Art. 311861</li> <li>• <b>SPD-kompatibel</b></li> <li>• inkl. Schrauben</li> <li>• 2 Stk. (für eine Seite) im Polybeutel</li> <li>• mit Exustar Eurolochheader</li> </ul>	<p><b>CLICK SYSTEM</b> »E-EMM276«</p> <ul style="list-style-type: none"> <li>• add-on for art. 311861</li> <li>• <b>SPD compatible</b></li> <li>• incl. bolts</li> <li>• 2 pcs. (for one side) in PE bag</li> <li>• with Exustar eurohole header</li> </ul> <div data-bbox="746 1153 935 1191" data-label="Text"> <p>Tested by the manufacturer based on ISO 4210</p> </div> <div data-bbox="837 1211 935 1234" data-label="Text"> <p>UVP 16,90 €</p> </div>	<div data-bbox="965 952 1340 1232" data-label="Image"> </div>
<p><b>311835</b> 40 pair</p>	<p><b>CLIP-ON KOMBIPEDAL</b></p> <ul style="list-style-type: none"> <li>• <b>Doppelfunktionspedale:</b> beidseitig verwendbar für normale (<b>Sport-)</b>Schuhe und für <b>Klick-Schuhe</b></li> <li>• <b>Aluminiumkörper</b> mit schwarzem <b>Aluminiumkäfig</b></li> <li>• <b>CNC-gefräste CrMo-Achse</b></li> <li>• mit <b>Industriekugellager</b></li> <li>• <b>abnehmbar in Sekunden</b> durch <b>QR-System</b></li> <li>• <b>schneller Pedalwechsel</b> zwischen Klick- und anderen Wellgo-Pedalen</li> <li>• durch Abnahme <b>Schutz vor Diebstahl</b> ("Wegfahrsperre")</li> <li>• Steckverbindung <b>passend für beide Seiten</b> (links + rechts), daher keine Verwechslung der Seiten möglich</li> <li>• mit Schuhplattenset (auch <b>passend für Shimano</b> Pedale)</li> <li>• Pedal passt auch für <b>Shimano</b> Schuhplatten (kein original Shimano Ersatzteil)</li> <li>• mit <b>Anti-Rutsch-Noppen</b> (inkl. 8 Ersatznoppen)</li> <li>• Trittfläche: 66 x 92 mm (L x B)</li> <li>• mit Wellgo Aufbewahrungstasche</li> </ul>	<p><b>CLIP-ON COMBINATION PEDAL</b></p> <ul style="list-style-type: none"> <li>• <b>double function pedals:</b> useable on both sides for normal (<b>sport-)</b>shoes and for <b>clipless shoes</b></li> <li>• <b>aluminium</b> body with black <b>aluminium cage</b></li> <li>• <b>CNC machined CrMo axle</b></li> <li>• with <b>sealed bearing</b></li> <li>• <b>detachable within seconds</b> by <b>QR System</b></li> <li>• <b>fast pedal change</b> between clipless and other wellgo pedals</li> <li>• detachable and therefore <b>protection against theft</b> ("immobiliser system")</li> <li>• clip connection <b>suitable for both sides</b> (left + right), therefore the sides cannot be mixed up</li> <li>• with cleat set (also <b>suitable for Shimano</b> pedals)</li> <li>• pedal also suitable for <b>Shimano</b> cleats (no original Shimano spare part)</li> <li>• with <b>non-slip knobs</b> (incl. 8 replacement knobs)</li> <li>• tread surface: 66 x 92 mm (L x W)</li> <li>• in Wellgo bag</li> </ul> <div data-bbox="746 2072 935 2110" data-label="Text"> <p>Tested by the manufacturer based on ISO 4210</p> </div> <div data-bbox="837 2130 935 2152" data-label="Text"> <p>UVP 99,90 €</p> </div>	<p><b>wellgo</b></p> <div data-bbox="965 1265 1340 2150" data-label="Image"> </div>

ART.-NR. 	BESCHREIBUNG	DESCRIPTION	
<b>311811</b> 30 pair	<b>KOMBIPEDAL ›E-PM86‹</b> <ul style="list-style-type: none"> <li>• <b>Doppelfunktionspedale:</b> beidseitig verwendbar für normale <b>(Sport-)Schuhe</b> und für <b>Klick-Schuhe</b></li> <li>• <b>Aluminiumkörper</b> und -käfig</li> <li>• silberne, <b>CNC-gefräste CrMo-Achse</b></li> <li>• mit <b>gedichtetem Industriekugellager</b> und <b>hochwertigem Gleitlager</b></li> <li>• mit abnehmbaren <b>Reflektoren</b></li> <li>• mit <b>deutschem Prüfzeichen</b></li> <li>• mit Schuhplattenset (auch <b>passend für Shimano Pedale</b>)</li> <li>• Pedal passt auch für <b>Shimano Schuhplatten</b> (kein original Shimano Ersatzteil)</li> <li>• nur <b>319 g/</b>Paar (ohne Reflektoren)</li> <li>• Trittfläche: 66 x 83 mm (L x B)</li> <li>• in Exustar Eurolochbox</li> </ul>	<b>COMBINATION PEDAL ›E-PM86‹</b> <ul style="list-style-type: none"> <li>• <b>double function pedals:</b> useable on both sides for normal <b>(sport-)shoes</b> and for <b>clipless shoes</b></li> <li>• <b>aluminium</b> body and cage</li> <li>• silver, <b>CNC machined CrMo</b> axle</li> <li>• with <b>sealed bearing</b> and <b>high quality bush bearing</b></li> <li>• with detachable <b>reflectors</b></li> <li>• with <b>German approval number</b></li> <li>• with cleat set (also <b>suitable for Shimano pedals</b>)</li> <li>• pedal also suitable for <b>Shimano cleats</b> (no original Shimano spare part)</li> <li>• only <b>319 g/</b>pair (without reflectors)</li> <li>• tread surface: 66 x 83 mm (L x W)</li> <li>• in Exustar eurohole box</li> </ul> <div style="text-align: center;">  <p>Tested by the manufacturer based on ISO 4210</p> </div> <p style="text-align: right;">UVP 58,90 €</p>	<div style="display: flex; justify-content: space-between;"> <div data-bbox="1177 235 1252 324">  319 g         </div> <div data-bbox="1404 224 1556 246"> <b>EXUSTAR</b> </div> </div> <div style="text-align: right;">  </div>    
<b>311807</b> 30 pair	<b>KOMBIPEDAL ›E-PM818‹</b> <ul style="list-style-type: none"> <li>• <b>Doppelfunktionspedale:</b> beidseitig verwendbar für normale <b>(Sport-)Schuhe</b> und für <b>Klick-Schuhe</b></li> <li>• <b>Aluminiumkörper</b> und -käfig</li> <li>• mit gedichteter <b>CrMo-Achse</b></li> <li>• <b>große Auflagefläche</b> auf der "Klick-Seite"</li> <li>• mit abnehmbaren <b>Reflektoren</b></li> <li>• mit <b>deutschem Prüfzeichen</b></li> <li>• mit Schuhplattenset (auch <b>passend für Shimano Pedale</b>)</li> <li>• Pedal passt auch für <b>Shimano Schuhplatten</b> (kein original Shimano Ersatzteil)</li> <li>• 435 g/Pair (ohne Reflektoren)</li> <li>• Montage mit <b>Innen- und Außen-sechskantschlüssel</b> möglich</li> <li>• Trittfläche: 67 x 96 mm (L x B)</li> <li>• in Exustar Eurolochbox</li> </ul>	<b>COMBINATION PEDAL ›E-PM818‹</b> <ul style="list-style-type: none"> <li>• <b>double function pedals:</b> useable on both sides for normal <b>(sport-)shoes</b> and for <b>clipless shoes</b></li> <li>• <b>aluminium</b> body and cage</li> <li>• with sealed <b>CrMo axle</b></li> <li>• <b>big area of support</b> on the "click side"</li> <li>• with detachable <b>reflectors</b></li> <li>• with <b>German approval number</b></li> <li>• with cleat set (also <b>suitable for Shimano pedals</b>)</li> <li>• pedal also suitable for <b>Shimano cleats</b> (no original Shimano spare part)</li> <li>• 435 g/pair (without reflectors)</li> <li>• mounting <b>possible with allen key</b> and <b>open hex wrench</b></li> <li>• tread surface: 67 x 96 mm (L x W)</li> <li>• in Exustar eurohole box</li> </ul> <div style="text-align: center;">  <p>Tested by the manufacturer based on ISO 4210</p> </div> <p style="text-align: right;">UVP 49,90 €</p>	  
<b>311099</b> 18/3 pair	<b>KOMBIPEDAL ›PEASY‹</b> <ul style="list-style-type: none"> <li>• <b>Doppelfunktionspedale:</b> beidseitig verwendbar für normale (Sport-)Schuhe und für Klick-Schuhe</li> <li>• <b>Aluminiumkörper</b> und -käfig</li> <li>• silberne, <b>CNC-gefräste CrMo-Achse</b></li> <li>• mit <b>Industriekugellagern</b></li> <li>• nur <b>319 g/</b>Paar (ohne Reflektoren)</li> <li>• mit abnehmbaren <b>Reflektoren</b></li> <li>• mit <b>deutschem Prüfzeichen</b></li> <li>• mit Schuhplattenset (auch passend für Shimano Pedale)</li> <li>• Pedal passt auch für Shimano Schuhplatten (kein original Shimano Ersatzteil)</li> <li>• Trittfläche: 63 x 80 mm (L x B)</li> <li>• auf M-Wave Eurolochkarte</li> </ul>	<b>COMBINATION PEDAL ›PEASY‹</b> <ul style="list-style-type: none"> <li>• <b>double function pedals:</b> useable on both sides for normal (sport-)shoes and for clipless shoes</li> <li>• <b>aluminium</b> body and cage</li> <li>• silver <b>CNC machined CrMo axle</b></li> <li>• with <b>sealed bearings</b></li> <li>• only <b>319 g/</b>pair (without reflectors)</li> <li>• with detachable <b>reflectors</b></li> <li>• with <b>German approval number</b></li> <li>• with cleat set (also suitable for Shimano pedals)</li> <li>• pedal also suitable for Shimano cleats (no original Shimano spare part)</li> <li>• tread surface: 63 x 80 mm (L x W)</li> <li>• on M-Wave eurohole card</li> </ul> <div style="text-align: center;">  <p>Tested by the manufacturer based on ISO 4210</p> </div> <p style="text-align: right;">UVP 43,90 €</p>	<div style="display: flex; justify-content: space-between;"> <div data-bbox="1177 1579 1252 1668">  319 g         </div> <div data-bbox="1460 1579 1556 1635"> <b>M-WAVE</b> </div> </div> <div style="text-align: right;">  </div>   

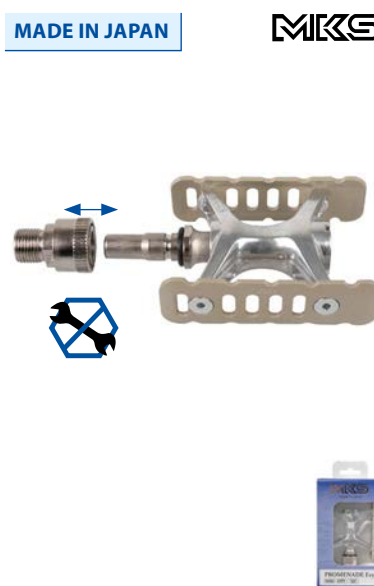
ART.-NR.	BESCHREIBUNG	DESCRIPTION	
<p><b>312060</b> 30/10 pair</p>	<p><b>KOMBIPEDAL</b> ›DRAG-T1‹</p> <ul style="list-style-type: none"> <li>• Aluminiumkörper</li> <li>• mit <b>Antirutschauflage</b></li> <li>• CrMo-Achse mit Innensechskantschlüssel-Kopf</li> <li>• mit Industriekugellager</li> <li>• nur 349 g/Pair</li> <li>• Pedal passt auch für <b>Shimano Schuhplatten</b> (kein original Shimano Ersatzteil)</li> <li>• Trittfläche: 95 x 73 mm (L x B)</li> <li>• auf M-Wave Eurolochkarte</li> </ul>	<p><b>COMBINATION PEDAL</b> ›DRAG-T1‹</p> <ul style="list-style-type: none"> <li>• <b>aluminium</b> body</li> <li>• with <b>non-slip rubber layer</b></li> <li>• CrMo-Achse axle with allen key head</li> <li>• with sealed bearing</li> <li>• only 349 g/pair</li> <li>• pedal also suitable for <b>Shimano cleats</b> (no original Shimano spare part)</li> <li>• tread surface: 95 x 73 mm (L x W)</li> <li>• on M-Wave eurohole card</li> </ul>  <p>Tested by the manufacturer based on ISO 4210</p> <p>UVP 45,90 €</p>	 <p>M-WAVE</p> <p>95 mm</p> <p>NON-SLIP</p>
<p><b>312061</b> 30/10 pair</p>	<p><b>KOMBIPEDAL</b> ›DRAG-T2‹</p> <ul style="list-style-type: none"> <li>• <b>Doppelfunktionspedale:</b> beidseitig verwendbar für normale (<b>Sport-)</b>Schuhe und für <b>Klick-Schuhe</b></li> <li>• Aluminiumkörper</li> <li>• <b>einfacher Einstieg</b></li> <li>• <b>verchromte CrMo</b>-Achse</li> <li>• Montage auch mit <b>Innensechskantschlüssel</b> möglich</li> <li>• mit <b>Non-Slip</b> Gummiauflage</li> <li>• mit Schuhplattenset (auch <b>passend für Shimano</b> Pedale)</li> <li>• Pedal passt auch für <b>Shimano Schuhplatten</b> (kein original Shimano Ersatzteil)</li> <li>• Trittfläche: 72 x 99 mm (L x B)</li> <li>• auf M-Wave Eurolochkarte</li> </ul>	<p><b>COMBINATION PEDAL</b> ›DRAG-T2‹</p> <ul style="list-style-type: none"> <li>• <b>double function pedals:</b> useable on both sides for normal (<b>sport-)</b>shoes and for <b>clipless shoes</b></li> <li>• <b>aluminium</b> body</li> <li>• <b>easy step-in system</b></li> <li>• <b>chromed CrMo</b> axle</li> <li>• mounting also possible with <b>allen key</b></li> <li>• with <b>non-slip</b> rubber layer</li> <li>• with cleat set (also <b>suitable for Shimano</b> pedals)</li> <li>• pedal also suitable for <b>Shimano cleats</b> (no original Shimano spare part)</li> <li>• tread surface: 72 x 99 mm (L x W)</li> <li>• on M-Wave eurohole card</li> </ul> <p>Tested by the manufacturer based on ISO 4210</p> <p>UVP 37,90 €</p>	 <p>M-WAVE</p> <p>NON-SLIP</p>
<p><b>311753</b> 40 pair</p>	<p><b>CLIP-ON PEDAL</b> ›PROMENADE EZY‹</p> <ul style="list-style-type: none"> <li>• <b>sehr hochwertig</b></li> <li>• <b>abnehmbares, universelles Clip-on Pedal</b></li> <li>• Aluminium, titanfinish</li> <li>• von <b>MKS (Japan)</b> hergestellt</li> <li>• symmetrischer Käfig</li> <li>• Trittfläche: 62 x 85 mm (L x B)</li> <li>• in MKS Eurolochbox</li> </ul>	<p><b>CLIP-ON PEDAL</b> ›PROMENADE EZY‹</p> <ul style="list-style-type: none"> <li>• <b>very high quality</b></li> <li>• <b>detachable, universal clip on pedal</b></li> <li>• aluminium, titanium finish</li> <li>• made by <b>MKS (Japan)</b></li> <li>• symmetric cage</li> <li>• tread surface: 62 x 85 mm (L x W)</li> <li>• in MKS eurohole box</li> </ul> <p>MADE IN JAPAN</p> <p>UVP 101,00 €</p>	 <p>MKS</p>



ART.-NR.	BESCHREIBUNG	DESCRIPTION	
<p><b>311719</b> silberner Käfig</p> <p><b>311720</b> schwarzer Käfig 50/10 pair</p>	<p><b>PEDAL</b></p> <ul style="list-style-type: none"> <li>• Aluminiumkörper und -käfig</li> <li>• schwarze CrMo-Achse</li> <li>• mit Industriekugellager</li> <li>• beidseitig verwendbar</li> <li>• mit Reflektoren</li> <li>• mit deutschem Prüfzeichen</li> <li>• Trittläche: 63 x 82 mm (L x B)</li> <li>• auf VP Eurolochkarte</li> </ul>	<p><b>PEDAL</b></p> <ul style="list-style-type: none"> <li>• aluminium body and cage</li> <li>• black CrMo axle</li> <li>• with sealed bearing</li> <li>• useable on both sides</li> <li>• with reflectors</li> <li>• with German approval number</li> <li>• tread surface: 63 x 82 mm (L x W)</li> <li>• on VP eurohole card</li> </ul> <p>Tested by the manufacturer based on ISO 4210</p> <p>UVP 29,90 €</p>	
<p><b>311079</b> 50/10 pair</p>	<p><b>PEDAL</b></p> <ul style="list-style-type: none"> <li>• Aluminiumkäfig</li> <li>• schwarze CrMo-Achse</li> <li>• rechts und links montierbar</li> <li>• mit Reflektoren</li> <li>• mit deutschem Prüfzeichen</li> <li>• Trittläche: 65 x 82 mm (L x B)</li> <li>• auf VP Eurolochkarte</li> </ul>	<p><b>PEDAL</b></p> <ul style="list-style-type: none"> <li>• aluminium cage</li> <li>• black CrMo axle</li> <li>• mountable on the right and on the left</li> <li>• with reflectors</li> <li>• with German approval number</li> <li>• tread surface: 65 x 82 mm (L x W)</li> <li>• on VP eurohole card</li> </ul> <p>Tested by the manufacturer based on ISO 4210</p> <p>UVP 16,90 €</p>	
<p><b>311710</b> Montageverpackung</p> <p><b>311109</b> auf M-Wave Eurolochkarte</p> <p><b>NEW</b> 40 pair</p>	<p><b>PEDAL</b></p> <ul style="list-style-type: none"> <li>• Aluminiumkörper und -käfig</li> <li>• silberne CrMo-Achse</li> <li>• mit deutschem Prüfzeichen</li> <li>• mit Reflektoren</li> <li>• Montage auch mit Innensechskant möglich</li> <li>• extra breite Trittläche: 82 x 103 mm (L x B)</li> </ul>	<p><b>PEDAL</b></p> <ul style="list-style-type: none"> <li>• aluminium body and cage</li> <li>• silver CrMo axle</li> <li>• with German approval number</li> <li>• with reflectors</li> <li>• mounting also possible with allen key</li> <li>• extra wide tread surface: 82 x 103 mm (L x W)</li> </ul> <p>OEM</p> <p>on M-Wave eurohole card</p> <p>Tested by the manufacturer based on ISO 4210</p> <p>UVP 16,90 €</p>	
<p><b>311024</b> Montageverpackung</p> <p><b>311112</b> auf M-Wave Eurolochkarte</p> <p><b>NEW</b></p> <p><b>311063</b> Montageverpackung</p> <p><b>311113</b> auf M-Wave Eurolochkarte</p> <p><b>NEW</b> 50 pair</p>	<p><b>PEDAL</b></p> <ul style="list-style-type: none"> <li>• Aluminiumkörper und -käfig</li> <li>• gedichtete, verchromte CrMo-Achse</li> <li>• Montage mit Innen- und Außen-sechskantschlüssel möglich</li> <li>• Trittläche: 64 x 94 mm (L x B)</li> </ul> <p><b>silberner Käfig</b></p> <p><b>311024</b> Montageverpackung</p> <p><b>311112</b> auf M-Wave Eurolochkarte</p> <p><b>schwarzer Käfig</b></p> <p><b>311063</b> Montageverpackung</p> <p><b>311113</b> auf M-Wave Eurolochkarte</p>	<p><b>PEDAL</b></p> <ul style="list-style-type: none"> <li>• aluminium body and cage</li> <li>• sealed, c. p. CrMo axle</li> <li>• mounting possible with allen key and open hex wrench</li> <li>• tread surface: 64 x 94 mm (L x W)</li> </ul> <p><b>silver cage</b></p> <p>OEM</p> <p>on M-Wave eurohole card</p> <p><b>black cage</b></p> <p>OEM</p> <p>on M-Wave eurohole card</p> <p>Tested by the manufacturer based on ISO 4210</p> <p>UVP 14,90 €</p>	



ART.-NR.	BESCHREIBUNG	DESCRIPTION	
<b>311920</b> 50 pair	<b>PEDAL</b> <ul style="list-style-type: none"> <li>• <b>Aluminiumkörper</b> und <b>-käfig</b></li> <li>• 9/16"-Achse mit <b>hochwertigem Polymer-Gleitlager</b></li> <li>• <b>beidseitig</b> verwendbar</li> <li>• mit <b>Reflektoren</b></li> <li>• Montage mit <b>Innensechskant</b></li> <li>• Trittfläche: 63 x 87 mm (L x B)</li> <li>• Montageverpackung</li> </ul> <p>Ohne deutsches Prüfzeichen - Verkauf und Nutzung im Geltungsbereich der StVZO (Deutschland) unzulässig (Abgabe nur an außerdeutsche Kunden).</p>	<b>PEDAL</b> <ul style="list-style-type: none"> <li>• <b>aluminium body</b> and <b>cage</b></li> <li>• 9/16" axle with <b>high-quality polymer plain bearing</b></li> <li>• <b>both treads</b> usable</li> <li>• with <b>reflectors</b></li> <li>• mounting with <b>allen key</b></li> <li>• tread surface: 63 x 87 mm (L x W)</li> <li>• OEM</li> </ul> <p>UVP 12,90 €</p>	
<b>311107</b> <b>311108</b> 50 pair	<b>PEDAL ›STEADY-A 2‹</b> <ul style="list-style-type: none"> <li>• <b>Aluminiumkörper</b> und <b>-käfig</b></li> <li>• 9/16"-<b>Boron</b>-Achse mit <b>hochwertigem Polymer-Gleitlager</b></li> <li>• mit <b>Reflektoren</b></li> <li>• mit <b>deutschem Prüfzeichen</b></li> <li>• Montage auch mit <b>Innensechskant-schlüssel</b> möglich</li> <li>• Trittfläche: 62 x 90 mm (L x B)</li> </ul> <p>Montageverpackung</p> <p>auf M-Wave Eurolochkarte</p>	<b>PEDAL ›STEADY-A 2‹</b> <ul style="list-style-type: none"> <li>• <b>aluminium body</b> and <b>cage</b></li> <li>• 9/16" <b>boron</b> axle with <b>high-quality polymer plain bearing</b></li> <li>• with <b>reflectors</b></li> <li>• with <b>German approval number</b></li> <li>• mounting also possible with <b>allen key</b></li> <li>• tread surface: 62 x 90 mm (L x W)</li> </ul> <p>OEM</p> <p>on M-Wave eurohole card</p> <p>Tested by the manufacturer based on ISO 4210</p> <p>UVP 14,90 €</p>	
<b>311317</b> <b>311320</b> 50 pair	<b>PEDAL ›STEADY-A‹</b> <ul style="list-style-type: none"> <li>• <b>Aluminiumkörper</b></li> <li>• <b>Stahlkäfig</b></li> <li>• mit <b>Reflektoren</b></li> <li>• mit <b>deutschem Prüfzeichen</b></li> <li>• Trittfläche: 60 x 92 mm (L x B)</li> </ul> <p>Montageverpackung</p> <p>auf M-Wave Eurolochkarte</p>	<b>PEDAL ›STEADY-A‹</b> <ul style="list-style-type: none"> <li>• <b>aluminium body</b></li> <li>• <b>steel cage</b></li> <li>• with <b>reflectors</b></li> <li>• with <b>German approval number</b></li> <li>• tread surface: 60 x 92 mm (L x W)</li> </ul> <p>OEM</p> <p>on M-Wave eurohole card</p> <p>UVP 9,90 €</p>	
<b>311049</b> <b>311114</b> <b>NEW</b> 50 pair	<b>PEDAL</b> <ul style="list-style-type: none"> <li>• <b>Aluminiumkörper</b> und <b>-käfig</b></li> <li>• Trittfläche: 70 x 94 mm (L x B)</li> </ul> <p>Montageverpackung</p> <p>auf M-Wave Eurolochkarte</p>	<b>PEDAL</b> <ul style="list-style-type: none"> <li>• <b>aluminium body</b> and <b>cage</b></li> <li>• tread surface: 70 x 94 mm (L x W)</li> </ul> <p>OEM</p> <p>on M-Wave eurohole card</p> <p>UVP 8,90 €</p>	
<b>311319</b> <b>311115</b> <b>NEW</b> 50 pair	<b>PEDAL</b> <ul style="list-style-type: none"> <li>• <b>Kunststoffkörper</b></li> <li>• <b>Stahlkäfig</b></li> <li>• mit <b>Reflektoren</b></li> <li>• mit <b>deutschem Prüfzeichen</b></li> <li>• Trittfläche: 61 x 95 mm (L x B)</li> </ul> <p>Montageverpackung</p> <p>auf M-Wave Eurolochkarte</p>	<b>PEDAL</b> <ul style="list-style-type: none"> <li>• <b>PP body</b></li> <li>• <b>steel cage</b></li> <li>• with <b>reflectors</b></li> <li>• with <b>German approval number</b></li> <li>• tread surface: 61 x 95 mm (L x W)</li> </ul> <p>OEM</p> <p>on M-Wave eurohole card</p> <p>UVP 8,90 €</p>	

ART.-NR. 	BESCHREIBUNG	DESCRIPTION	
<b>311834</b> 50 pair	<b>CLIP-ON ANTI-RUTSCHPEDAL</b> <ul style="list-style-type: none"> <li>• <b>Aluminiumkörper</b> und Kunststoffkäfig</li> <li>• <b>CrMo</b>-Achse</li> <li>• <b>abnehmbar in Sekunden</b> durch <b>QR System</b></li> <li>• <b>schneller Pedalwechsel</b> zwischen Clipless und anderen Pedalen</li> <li>• durch Abnahme <b>Schutz vor Diebstahl</b> ("Wegfahrsperre")</li> <li>• Steckverbindung <b>passend für beide Seiten</b> (links und rechts), daher keine Verwechslung der Seiten möglich)</li> <li>• mit <b>deutschem Prüfzeichen</b></li> <li>• mit schwarzer <b>Non-Slip Gummiauflage</b></li> <li>• mit <b>Reflektoren</b></li> <li>• Trittfläche: 80 x 93 mm (L x B)</li> <li>• mit Wellgo Aufbewahrungstasche</li> </ul>	<b>CLIP-ON NON-SLIP PEDAL</b> <ul style="list-style-type: none"> <li>• <b>aluminium body</b> and plastic cage</li> <li>• <b>CrMo</b> axle</li> <li>• <b>detachable within seconds</b> by <b>QR system</b></li> <li>• <b>fast pedal change</b> between Clipless and other pedals</li> <li>• detachable and therefore <b>protection against theft</b> ("immobiliser system")</li> <li>• clip connection <b>fits for both sides</b> (left and right), therefore the sides cannot be mixed up</li> <li>• with <b>German approval number</b></li> <li>• with black <b>non-slip rubber layer</b></li> <li>• with <b>reflectors</b></li> <li>• tread surface: 80 x 93 mm (L x W)</li> <li>• in Wellgo bag</li> </ul> <p style="text-align: right; font-size: small;">Tested by the manufacturer based on ISO 4210</p> <p style="text-align: right;">UVP 43,90 €</p>	     <p style="font-size: x-small;">Art. 311839</p> 
<b>311035</b> 50/10 pair	<b>ANTI-RUTSCHPEDAL</b> <ul style="list-style-type: none"> <li>• <b>Aluminiumkörper</b> und Kunststoffkäfig</li> <li>• <b>CNC-gefräste CrMo</b>-Achse</li> <li>• mit <b>Industriekugellager</b></li> <li>• mit <b>deutschem Prüfzeichen</b></li> <li>• mit grauer <b>Non-Slip Gummiauflage</b></li> <li>• mit <b>Reflektoren</b></li> <li>• Trittfläche: 79 x 90 mm (L x B)</li> <li>• auf VP Eurolochkarte</li> </ul>	<b>NON-SLIP PEDAL</b> <ul style="list-style-type: none"> <li>• <b>aluminium body</b> and plastic cage</li> <li>• <b>CNC machined CrMo</b> axle</li> <li>• with <b>sealed bearing</b></li> <li>• with <b>German approval number</b></li> <li>• with grey <b>non-slip rubber layer</b></li> <li>• with <b>reflectors</b></li> <li>• tread surface: 79 x 90 mm (L x W)</li> <li>• on VP eurohole card</li> </ul> <p style="text-align: right; font-size: small;">Tested by the manufacturer based on ISO 4210</p> <p style="text-align: right;">UVP 34,90 €</p>	   
<b>311060</b> 30 pair	<b>ANTI-RUTSCHPEDAL ›E-PC97‹</b> <ul style="list-style-type: none"> <li>• <b>Aluminiumkörper</b> und -käfig</li> <li>• <b>CNC-gefräste CrMo</b>-Achse</li> <li>• mit <b>Industriekugellager</b></li> <li>• mit <b>deutschem Prüfzeichen</b></li> <li>• mit <b>Reflektoren</b></li> <li>• Trittfläche: 69 x 90 mm (L x B)</li> <li>• auf Exustar Eurolochkarte</li> </ul>	<b>NON-SLIP PEDAL ›E-PC97‹</b> <ul style="list-style-type: none"> <li>• <b>aluminium body</b> and cage</li> <li>• <b>CNC machined CrMo</b> axle</li> <li>• with <b>sealed bearing</b></li> <li>• with <b>German approval number</b></li> <li>• with <b>reflectors</b></li> <li>• tread surface: 69 x 90 mm (L x W)</li> <li>• on Exustar eurohole card</li> </ul> <p style="text-align: right; font-size: small;">Tested by the manufacturer based on ISO 4210</p> <p style="text-align: right;">UVP 28,90 €</p>	   
<b>NEW</b>	<b>ANTI-RUTSCHPEDAL</b> <ul style="list-style-type: none"> <li>• schwarzer <b>Aluminiumkörper</b></li> <li>• mit schwarzer <b>Non-Slip Gummiauflage</b></li> <li>• mit <b>deutschem Prüfzeichen</b></li> <li>• mit <b>Reflektoren</b></li> <li>• Trittfläche: 80 x 92 mm (L x B)</li> </ul>	<b>NON-SLIP PEDAL</b> <ul style="list-style-type: none"> <li>• <b>black aluminium body</b></li> <li>• with black <b>non-slip rubber layer</b></li> <li>• with <b>German approval number</b></li> <li>• with <b>reflectors</b></li> <li>• tread surface: 80 x 92 mm (L x W)</li> </ul>	     <p style="text-align: right;">UVP 19,90 €</p>
<b>311509</b>	Montageverpackung	OEM	
<b>311504</b> 50 pair	auf M-Wave Eurolochkarte	on M-Wave eurohole card	

ART.-NR.	BESCHREIBUNG	DESCRIPTION	
<p><b>312012</b></p> <p><b>NEW</b></p> <p><b>312013</b> 50 pair</p>	<p><b>ANTI-RUTSCHPEDAL</b> ›STEADY FLAT 2 AL‹</p> <ul style="list-style-type: none"> <li>• Aluminiumkörper</li> <li>• Boron-Achse</li> <li>• mit hochwertigem Polymer-Gleitlager</li> <li>• mit deutschem Prüfzeichen</li> <li>• mit Non-Slip Gummiauflage</li> <li>• mit Reflektoren</li> <li>• Trittfläche: 82 x 96 mm (L x B)</li> <li>• Montage auch mit Innensechskant möglich</li> </ul> <p>Montageverpackung</p> <p>auf M-Wave Eurolochkarte</p>	<p><b>NON-SLIP PEDAL</b> ›STEADY FLAT 2 AL‹</p> <ul style="list-style-type: none"> <li>• aluminium body</li> <li>• Boron axle</li> <li>• with high-quality polymer plain bearing</li> <li>• with German approval number</li> <li>• with non-slip rubber layer</li> <li>• with reflector</li> <li>• tread surface: 82 x 96 mm (L x W)</li> <li>• mounting also possible with allen key</li> </ul> <p>OEM</p> <p>on M-Wave eurohole card</p> <p><small>Tested by the manufacturer based on ISO 4210</small></p> <p>UVP 19,90 €</p>	   
<p><b>311830</b></p> <p><b>NEW</b></p> <p><b>311116</b> 30 pair</p>	<p><b>ANTI-RUTSCHPEDAL</b></p> <ul style="list-style-type: none"> <li>• Aluminiumkörper und -käfig</li> <li>• mit großer schwarzer Gummiauflagefläche</li> <li>• Boron-Achse</li> <li>• mit deutschem Prüfzeichen</li> <li>• mit Reflektoren</li> <li>• Trittfläche: 73 x 97 mm (L x B)</li> </ul> <p>Montageverpackung</p> <p>auf M-Wave Eurolochkarte</p>	<p><b>NON-SLIP PEDAL</b></p> <ul style="list-style-type: none"> <li>• aluminium body and cage</li> <li>• with big black rubber surface</li> <li>• boron axle</li> <li>• with German approval number</li> <li>• with reflectors</li> <li>• tread surface: 73 x 97 mm (L x W)</li> </ul> <p>OEM</p> <p>on M-Wave eurohole card</p> <p><small>Tested by the manufacturer based on ISO 4210</small></p> <p>UVP 16,90 €</p>	   
<p><b>311106</b></p> <p><b>NEW</b></p> <p><b>311117</b> 50 pair</p>	<p><b>ANTI-RUTSCHPEDAL</b></p> <ul style="list-style-type: none"> <li>• Aluminiumkörper und -käfig</li> <li>• anatomisch geformte, konkave Trittfläche mit Aluminium-Non-Slip-Profil</li> <li>• schwarze, gedichtete Boron-Achse</li> <li>• mit Reflektoren</li> <li>• mit deutschem Prüfzeichen</li> <li>• nur 379 g/Pair</li> <li>• Trittfläche: 81 x 97 mm (L x B)</li> </ul> <p>Montageverpackung</p> <p>auf M-Wave Eurolochkarte</p>	<p><b>NON-SLIP PEDAL</b></p> <ul style="list-style-type: none"> <li>• aluminium body and cage</li> <li>• anatomic shaped, concave platform with aluminium non slip profile</li> <li>• black, sealed boron axle</li> <li>• with reflectors</li> <li>• with German approval number</li> <li>• only 379 g/pair</li> <li>• tread surface: 81 x 97 mm (L x W)</li> </ul> <p>OEM</p> <p>on M-Wave eurohole card</p> <p>UVP 12,90 €</p>	   <p><b>ANATOMIC</b></p>  

ART.-NR. 	BESCHREIBUNG	DESCRIPTION	
<p><b>311121</b></p> <p><b>NEW</b></p> <p><b>311040</b> 50 pair</p>	<p><b>ANTI-RUTSCHPEDAL ›STEADY C‹</b></p> <ul style="list-style-type: none"> <li>• Aluminiumkörper</li> <li>• CrMo-Achse</li> <li>• mit Non-Slip Gummiauflage</li> <li>• mit Reflektoren</li> <li>• mit deutschem Prüfzeichen</li> <li>• Montage auch mit Innensechskant möglich</li> <li>• Trittfläche: 80 x 95 mm (L x B)</li> </ul> <p>Montageverpackung</p> <p>auf M-Wave Eurolochkarte</p>	<p><b>NON-SLIP PEDAL ›STEADY C‹</b></p> <ul style="list-style-type: none"> <li>• aluminium body</li> <li>• CrMo axle</li> <li>• with non-slip rubber layer</li> <li>• with reflectors</li> <li>• with German approval number</li> <li>• mounting also possible with allen key</li> <li>• tread surface: 80 x 95 mm (L x W)</li> </ul> <p>OEM</p> <p>on M-Wave eurohole card</p> <p>UVP 11,90 €</p>	   
<p><b>311000</b></p> <p><b>NEW</b></p> <p><b>311122</b> 50 pair</p>	<p><b>ANTI-RUTSCHPEDAL</b></p> <ul style="list-style-type: none"> <li>• Aluminiumkörper und -käfig</li> <li>• CNC-gefräste CrMo-Achse</li> <li>• mit Non-Slip Gummiauflage</li> <li>• mit Kugellager</li> <li>• mit Reflektoren</li> <li>• mit deutschem Prüfzeichen</li> <li>• Trittfläche: 70 x 95 mm (L x B)</li> </ul> <p>Montageverpackung</p> <p>auf M-Wave Eurolochkarte</p>	<p><b>NON-SLIP PEDAL</b></p> <ul style="list-style-type: none"> <li>• aluminium body and cage</li> <li>• CNC machined CrMo axle</li> <li>• with non-slip rubber layer</li> <li>• with ball bearing</li> <li>• with reflectors</li> <li>• with German approval number</li> <li>• tread surface: 70 x 95 mm (L x W)</li> </ul> <p>OEM</p> <p>on M-Wave eurohole card</p> <p><small>Tested by the manufacturer based on ISO 4210</small></p> <p>UVP 12,90 €</p>	   
<p><b>311002</b></p> <p><b>NEW</b></p> <p><b>311123</b> 50 pair</p>	<p><b>ANTI-RUTSCHPEDAL</b></p> <ul style="list-style-type: none"> <li>• Aluminiumkörper und -käfig</li> <li>• mit Non-Slip Gummiauflage</li> <li>• mit Reflektoren</li> <li>• mit deutschem Prüfzeichen</li> <li>• Trittfläche: 70 x 96 mm (L x B)</li> </ul> <p>Montageverpackung</p> <p>auf M-Wave Eurolochkarte</p>	<p><b>NON-SLIP PEDAL</b></p> <ul style="list-style-type: none"> <li>• aluminium body and cage</li> <li>• with non-slip rubber layer</li> <li>• with reflectors</li> <li>• with German approval number</li> <li>• tread surface: 70 x 96 mm (L x W)</li> </ul> <p>OEM</p> <p>on M-Wave eurohole card</p> <p>UVP 9,90 €</p>	   
<p><b>NEW</b></p> <p><b>311139</b></p> <p><b>311140</b> 50 pair</p>	<p><b>ANTI-RUTSCHPEDAL ›STEADY SAND‹</b></p> <ul style="list-style-type: none"> <li>• Aluminiumkörper mit sandartiger Anti-Rutschauflage</li> <li>• mit Industriekugellager</li> <li>• CrMo-Achse</li> <li>• mit deutschem Prüfzeichen</li> <li>• mit Reflektoren</li> <li>• Trittfläche: 85 x 92 mm (L x B)</li> </ul> <p>Montageverpackung</p> <p>auf M-Wave Eurolochkarte</p>	<p><b>NON-SLIP PEDAL ›STEADY SAND‹</b></p> <ul style="list-style-type: none"> <li>• aluminium body with sandlike non-slip layer</li> <li>• with sealed bearing</li> <li>• CrMo axle</li> <li>• with German approval number</li> <li>• with reflectors</li> <li>• tread surface: 85 x 92 mm (L x W)</li> </ul> <p>OEM</p> <p>on M-Wave eurohole card</p> <p>UVP 41,90 €</p>	   



ART.-NR.	BESCHREIBUNG	DESCRIPTION	
<p><b>313176</b></p> <p><b>311048</b> 50/10 pair</p>	<p><b>ANTI-RUTSCHPEDAL ›SAND‹</b></p> <ul style="list-style-type: none"> <li>• schwarzer Kunststoffkörper mit <b>sandartiger Anti-Rutschauflage</b></li> <li>• <b>anatomisch</b> geformte, konkave Auflagefläche</li> <li>• mit <b>Reflektoren</b></li> <li>• mit <b>deutschem Prüfzeichen</b></li> <li>• Trittfläche: 88 x 100 mm (L x B)</li> <li>• auf VP Eurolochkarte</li> </ul> <p>• <b>CrMo</b>-Achse</p> <p>• mit <b>Industriekugellager</b></p> <p>• <b>Boron</b>-Achse</p> <p>• mit <b>Kugellager</b></p>	<p><b>NON-SLIP PEDAL ›SAND‹</b></p> <ul style="list-style-type: none"> <li>• black plastic body with <b>sandlike non-slip layer</b></li> <li>• <b>anatomically</b> shaped concave supporting surface</li> <li>• with <b>reflectors</b></li> <li>• with <b>German approval number</b></li> <li>• tread surface: 88 x 100 mm (L x W)</li> <li>• on VP eurohole card</li> </ul> <p>• <b>CrMo</b> axle</p> <p>• with <b>sealed bearing</b></p> <p>UVP 39,90 €</p> <p>• <b>boron</b> axle</p> <p>• with <b>ball bearing</b></p> <p>UVP 25,90 €</p>	<p><b>SANDLIKE SURFACE</b></p> <p><b>ANATOMIC</b></p> <p>Tested by the manufacturer according to Zedler "Advanced Plus Standard"   Tested by the manufacturer based on ISO 4210</p>
<p><b>311523</b></p> <p>• <b>311503</b> 50 pair</p>	<p><b>ANTI-RUTSCHPEDAL ›STEADY FLAT‹</b></p> <ul style="list-style-type: none"> <li>• <b>Kunststoffkörper</b> mit <b>sandartiger Anti-Rutschauflage</b></li> <li>• <b>Boron</b>-Achse</li> <li>• mit hochwertigem <b>Polymer-Gleitlager</b></li> <li>• mit <b>deutschem Prüfzeichen</b></li> <li>• mit <b>Reflektoren</b></li> <li>• Montage auch mit <b>Innensechskant</b> möglich</li> <li>• Trittfläche: 86 x 96 mm (L x B)</li> </ul> <p>auf M-Wave Eurolochkarte</p> <p>Montageverpackung</p>	<p><b>NON-SLIP PEDAL ›STEADY FLAT‹</b></p> <ul style="list-style-type: none"> <li>• <b>plastic body</b> with <b>sandlike non-slip layer</b></li> <li>• <b>boron</b> axle</li> <li>• with high-quality <b>polymer plain bearing</b></li> <li>• with <b>german approval number</b></li> <li>• with <b>reflectors</b></li> <li>• mounting also possible with <b>allen key</b></li> <li>• tread surface: 86 x 96 mm (L x W)</li> </ul> <p>on M-Wave eurohole card</p> <p>OEM</p> <p>UVP 12,90 €</p>	<p><b>SANDLIKE SURFACE</b></p>
<p><b>311502</b></p> <p>• <b>311500</b> 50 pair</p>	<p><b>ANTI-RUTSCHPEDAL ›STEADY BEACH‹</b></p> <ul style="list-style-type: none"> <li>• schwarzer Kunststoffkörper mit <b>doppelter Anti-Rutschauflage</b>: <ul style="list-style-type: none"> <li>- sandartige Oberfläche</li> <li>- high-low Noppen</li> </ul> </li> <li>• <b>Boron</b>-Achse</li> <li>• anatomisch geformte, konkave Auflagefläche</li> <li>• mit <b>Reflektoren</b></li> <li>• mit <b>deutschem Prüfzeichen</b></li> <li>• Montage auch mit <b>Innensechskant</b> möglich</li> <li>• Trittfläche: 89 x 97 mm (L x B)</li> </ul> <p>auf M-Wave Eurolochkarte</p> <p>Montageverpackung</p>	<p><b>NON-SLIP PEDAL ›STEADY BEACH‹</b></p> <ul style="list-style-type: none"> <li>• black plastic body with <b>double non-slip layer</b> <ul style="list-style-type: none"> <li>- sandlike surface</li> <li>- high-low knobs</li> </ul> </li> <li>• <b>boron</b> axle</li> <li>• anatomisch shaped concave supporting surface</li> <li>• with <b>reflectors</b></li> <li>• with <b>German approval number</b></li> <li>• mounting also possible with <b>allen key</b></li> <li>• tread surface: 89 x 97 mm (L x W)</li> </ul> <p>on M-Wave eurohole card</p> <p>OEM</p> <p>UVP 8,90 €</p>	<p><b>HIGH-LOW KNOBS</b></p> <p><b>SANDLIKE SURFACE</b></p> <p><b>ANATOMIC</b></p>

# ANTI-RUTSCHPEDALE NON-SLIP PEDALS











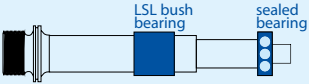

ART.-NR. 	BESCHREIBUNG	DESCRIPTION	
<b>311506</b> 50/10 pair 	<b>ANTI-RUTSCHPEDAL</b> <ul style="list-style-type: none"> <li>• Kunststoffkörper</li> <li>• <b>Boron</b>-Achse</li> <li>• mit hochwertigem <b>Polymer-Gleitlager</b></li> <li>• mit <b>Non-Slip Gummiauflage</b></li> <li>• mit <b>Reflektoren</b></li> <li>• mit <b>deutschem Prüfzeichen</b></li> <li>• Trittläche: 81 x 93 mm (L x B)</li> <li>• auf VP Eurolochkarte</li> </ul>	<b>NON-SLIP PEDAL</b> <ul style="list-style-type: none"> <li>• plastic body</li> <li>• <b>boron</b> axle</li> <li>• with high-quality <b>polymer plain bearing</b></li> <li>• with <b>non-slip rubber layer</b></li> <li>• with <b>reflectors</b></li> <li>• with <b>German approval number</b></li> <li>• tread surface: 81 x 93 mm (L x W)</li> <li>• on VP eurohole card</li> </ul> <p style="text-align: right; font-size: small;">Tested by the manufacturer based on ISO 4210</p> <p style="text-align: right;">UVP 10,90 €</p>	  
<b>311124</b> <b>NEW</b> <b>311041</b> 50 pair	<b>ANTI-RUTSCHPEDAL</b> <ul style="list-style-type: none"> <li>• Kunststoffkörper</li> <li>• <b>CrMo</b>-Achse</li> <li>• mit <b>Kugellager</b></li> <li>• mit <b>Non-Slip Gummiauflage</b></li> <li>• mit <b>Reflektoren</b></li> <li>• mit <b>deutschem Prüfzeichen</b></li> <li>• Montage auch mit <b>Innensechskant</b> möglich</li> <li>• Trittläche: 80 x 95 mm (L x B)</li> </ul> Montageverpackung auf M-Wave Eurolochkarte	<b>NON-SLIP PEDAL</b> <ul style="list-style-type: none"> <li>• plastic body</li> <li>• <b>CrMo</b> axle</li> <li>• with <b>ball bearing</b></li> <li>• with <b>non-slip rubber layer</b></li> <li>• with <b>reflectors</b></li> <li>• with <b>German approval number</b></li> <li>• mounting also possible with <b>allen key</b></li> <li>• tread surface: 80 x 95 mm (L x W)</li> </ul> OEM on M-Wave eurohole card UVP 6,90 €	  
<b>312008</b> 30 pair	<b>ANTI-RUTSCHPEDAL</b> <ul style="list-style-type: none"> <li>• mit <b>Non-Slip TPR-Auflage</b></li> <li>• mit <b>Kugellager</b></li> <li>• mit <b>Reflektoren</b></li> <li>• mit <b>deutschem Prüfzeichen</b></li> <li>• mit <b>extra großer Trittläche</b>: 85 x 98 mm (L x B)</li> <li>• Montageverpackung</li> </ul>	<b>NON-SLIP PEDAL</b> <ul style="list-style-type: none"> <li>• with <b>non-slip TPR-layer</b></li> <li>• with <b>ball bearing</b></li> <li>• with <b>reflectors</b></li> <li>• with <b>German approval number</b></li> <li>• with <b>extra wide tread surface</b>: 85 x 98 mm (L x W)</li> <li>• OEM</li> </ul> UVP 5,90 €	 
<b>311011</b>   <b>311508</b> <b>311125</b> <b>NEW</b> 50 pair	wie Art. 312008, aber: <ul style="list-style-type: none"> <li>• 75 x 96 mm (L x B)</li> </ul> mit <b>deutschem Prüfzeichen</b> Montageverpackung ohne deutsches Prüfzeichen Montageverpackung auf M-Wave Eurolochkarte Ohne deutsches Prüfzeichen - Verkauf und Nutzung im Geltungsbereich der StVZO (Deutschland) unzulässig (Abgabe nur an außerdeutsche Kunden).	like art. 312008, but: <ul style="list-style-type: none"> <li>• 75 x 96 mm (L x W)</li> </ul> with <b>German approval number</b> OEM without German approval number OEM on M-Wave eurohole card UVP 4,90 €	 <b>ORIGINAL NON-SLIP</b>  
<b>312000</b> 50 pair	<b>PEDAL</b> <ul style="list-style-type: none"> <li>• Non-Slip Optik</li> <li>• Kunststoffkörper</li> <li>• <b>Boron</b>-Achse</li> <li>• mit <b>Kugellager</b></li> <li>• mit <b>Reflektoren</b></li> <li>• Trittläche: 73 x 94 mm (L x B)</li> <li>• Montageverpackung</li> </ul> Ohne deutsches Prüfzeichen - Verkauf und Nutzung im Geltungsbereich der StVZO (Deutschland) unzulässig (Abgabe nur an außerdeutsche Kunden).	<b>PEDAL</b> <ul style="list-style-type: none"> <li>• non-slip optic</li> <li>• plastic body</li> <li>• <b>boron</b> axle</li> <li>• with <b>ball bearing</b></li> <li>• with <b>reflectors</b></li> <li>• tread surface: 73 x 94 mm (L x W)</li> <li>• OEM</li> </ul> UVP 3,90 €	

ART.-NR.	BESCHREIBUNG	DESCRIPTION	
<b>312134</b> 50 pair	<b>BLOCKPEDAL</b> <ul style="list-style-type: none"> <li>Aluminiumkörper</li> <li>mit <b>Reflektoren</b></li> <li>mit <b>deutschem Prüfzeichen</b></li> <li>Trittläche: 67 x 92 mm (L x B)</li> <li>Montageverpackung</li> </ul>	<b>PEDAL</b> <ul style="list-style-type: none"> <li>aluminium body</li> <li>with <b>reflectors</b></li> <li>with <b>German approval number</b></li> <li>tread surface: 67 x 92 mm (L x W)</li> <li>OEM</li> </ul>	  UVP 9,90 €
<b>311301</b> 50 pair  <b>311302</b> 40 pair	<b>BLOCKPEDAL</b> <ul style="list-style-type: none"> <li>Stahlachse</li> <li>mit <b>Reflektoren</b></li> <li>auswechselbare Gummiblöcke</li> <li>Trittläche: 72 x 92 mm (L x B)</li> <li>Montageverpackung</li> </ul> mit <b>deutschem Prüfzeichen</b>  ohne deutsches Prüfzeichen Ohne deutsches Prüfzeichen - Verkauf und Nutzung im Geltungsbereich der StVZO (Deutschland) unzulässig (Abgabe nur an außerdeutsche Kunden).	<b>PEDAL</b> <ul style="list-style-type: none"> <li>steel axle</li> <li>with <b>reflectors</b></li> <li>exchangeable rubber blocks</li> <li>tread surface: 72 x 92 mm (L x W)</li> <li>OEM</li> </ul> with <b>German approval number</b>  without German approval number	  UVP 8,90 €  UVP 5,90 €
 <b>312011</b>  <b>312010</b> 50 pair	<b>ANTI-RUTSCHPEDAL</b> <b>&gt;STEADY FLAT 2&lt;</b> <ul style="list-style-type: none"> <li><b>Non-Slip Profil</b></li> <li>Kunststoffkörper</li> <li><b>Boron-Achse</b></li> <li>mit hochwertigem <b>Polymer-Gleitlager</b></li> <li>Montage auch mit <b>Innensechskant</b> möglich</li> <li>mit <b>Reflektoren</b></li> <li>mit <b>deutschem Prüfzeichen</b></li> <li>Trittläche: 84 x 93 mm (L x B)</li> </ul> auf M-Wave Eurolochkarte Montageverpackung	<b>NON-SLIP PEDAL</b> <b>&gt;STEADY FLAT 2&lt;</b> <ul style="list-style-type: none"> <li><b>non-slip profile</b></li> <li>plastic body</li> <li><b>boron axle</b></li> <li>with high-quality <b>polymer plain bearing</b></li> <li>mounting also possible with <b>allen key</b></li> <li>with <b>reflectors</b></li> <li>with <b>german approval number</b></li> <li>tread surface: 84 x 93 mm (L x W)</li> </ul> on M-Wave eurohole card OEM	    UVP 6,90 €
<b>313300</b>	<b>PEDAL</b> <ul style="list-style-type: none"> <li>schwarzer Kunststoffkörper</li> <li>mit <b>Reflektoren</b></li> </ul> <b>mit Gleitlager</b> Trittläche: 71 x 99 mm (L x B) <ul style="list-style-type: none"> <li>ohne deutsches Prüfzeichen</li> <li>Montageverpackung</li> </ul> Ohne deutsches Prüfzeichen - Verkauf und Nutzung im Geltungsbereich der StVZO (Deutschland) unzulässig (Abgabe nur an außerdeutsche Kunden).	<b>PEDAL</b> <ul style="list-style-type: none"> <li>black plastic body</li> <li>with <b>reflectors</b></li> </ul> <b>with plain bearing</b> tread surface: 71 x 99 mm (L x W) <ul style="list-style-type: none"> <li>without German approval number</li> <li>OEM</li> </ul>	 UVP 2,90 €
<b>313306</b> <b>311126</b> <b>NEW</b>  <b>313301</b> <b>311127</b> <b>NEW</b> 50 pair	<ul style="list-style-type: none"> <li>mit <b>Kugellager</b></li> <li>Trittläche: 72 x 95 mm (L x B)</li> <li>mit <b>deutschem Prüfzeichen</b></li> </ul> Montageverpackung auf M-Wave Eurolochkarte  ohne deutsches Prüfzeichen Montageverpackung auf M-Wave Eurolochkarte Ohne deutsches Prüfzeichen - Verkauf und Nutzung im Geltungsbereich der StVZO (Deutschland) unzulässig (Abgabe nur an außerdeutsche Kunden).	<ul style="list-style-type: none"> <li>with <b>ball bearing</b></li> <li>tread surface: 72 x 95 mm (L x W)</li> <li>with <b>German approval number</b></li> </ul> OEM on M-Wave eurohole card  without German approval number OEM on M-Wave eurohole card	   UVP 4,90 €  UVP 3,90 €

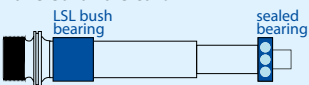
ART.-NR.	BESCHREIBUNG	DESCRIPTION	
<p><b>311046</b> Montageverpackung</p> <p><b>311128</b> auf M-Wave Eurolochkarte</p> <p><b>NEW</b></p> <p>50 pair</p>	<p><b>KINDER- UND JUGEND-ANTI-RUTSCHPEDAL</b></p> <ul style="list-style-type: none"> <li>• schwarzer Kunststoffkörper</li> <li>• mit grauer <b>Non-Slip Gummiauflage</b></li> <li>• mit <b>Reflektoren</b></li> <li>• mit <b>deutschem Prüfzeichen</b></li> <li>• Trittfläche: 60 x 82 mm (L x B)</li> </ul>	<p><b>KIDS AND JUVENILE NON-SLIP PEDAL</b></p> <ul style="list-style-type: none"> <li>• black PP body</li> <li>• with grey <b>non-slip rubber layer</b></li> <li>• with <b>reflectors</b></li> <li>• with <b>German approval number</b></li> <li>• tread surface: 60 x 82 mm (L x W)</li> </ul> <p>OEM</p> <p>on M-Wave eurohole card</p> <p>UVP 4,90 €</p>	
<p><b>311033</b> mit <b>deutschem Prüfzeichen</b></p> <p>50 pair</p> <p><math>\frac{1}{16}</math>" Achse</p> <p><b>311028</b> <math>\frac{1}{16}</math>" Achse</p> <p><b>311030</b> <math>\frac{1}{2}</math>" Achse</p> <p>50 pair</p>	<p><b>KINDER- UND JUGENDPEDAL</b></p> <ul style="list-style-type: none"> <li>• <b>MTB Design</b></li> <li>• schwarzer Kunststoffkörper</li> <li>• mit <b>Reflektoren</b></li> <li>• Gleitlager</li> <li>• Trittfläche: 56 x 83 mm (L x B)</li> <li>• Montageverpackung</li> </ul> <p>ohne deutsches Prüfzeichen</p>	<p><b>KIDS AND JUVENILE PEDAL</b></p> <ul style="list-style-type: none"> <li>• <b>MTB design</b></li> <li>• black PP body</li> <li>• with <b>reflectors</b></li> <li>• plain bearing</li> <li>• tread surface: 56 x 83 mm (L x W)</li> <li>• OEM</li> </ul> <p>with <b>German approval number</b></p> <p><math>\frac{1}{16}</math>" axle</p> <p>UVP 3,90 €</p> <p>without German approval number</p> <p><math>\frac{1}{16}</math>" axle</p> <p><math>\frac{1}{2}</math>" axle</p> <p>UVP 2,90 €</p> <p>Ohne deutsches Prüfzeichen - Verkauf und Nutzung im Geltungsbereich der StVZO (Deutschland) unzulässig (Abgabe nur an außerdeutsche Kunden).</p>	
<p><b>311765</b> Montageverpackung</p> <p><b>311129</b> auf M-Wave Eurolochkarte</p> <p><b>NEW</b></p> <p>50 pair</p>	<p><b>FALTPEDAL</b></p> <ul style="list-style-type: none"> <li>• <b>Aluminium/Kunststoffkörper</b></li> <li>• <b>CrMo-Achse</b></li> <li>• <b>leicht und sicher faltbar</b></li> <li>• <b>beidseitig</b> verwendbar</li> <li>• mit <b>Non-Slip Gummiauflage</b></li> <li>• mit <b>Reflektoren</b></li> <li>• mit <b>deutschem Prüfzeichen</b></li> <li>• Trittfläche: 69 x 98 mm (L x B)</li> </ul>	<p><b>FOLDING PEDAL</b></p> <ul style="list-style-type: none"> <li>• <b>aluminium/PP body</b></li> <li>• <b>CrMo axle</b></li> <li>• <b>simply and safely foldable</b></li> <li>• usable on <b>both sides</b></li> <li>• with <b>non-slip rubber layer</b></li> <li>• with <b>reflectors</b></li> <li>• with <b>German approval number</b></li> <li>• tread surface: 69 x 98 mm (L x W)</li> </ul> <p>OEM</p> <p>on M-Wave eurohole card</p> <p>UVP 13,90 €</p>	
<p><b>312137</b></p> <p>50 pair</p>	<p><b>FALTPEDAL</b></p> <ul style="list-style-type: none"> <li>• Kunststoffkörper</li> <li>• <b>Boron-Achse</b></li> <li>• mit <b>Reflektoren</b></li> <li>• mit <b>deutschem Prüfzeichen</b></li> <li>• Trittfläche: 72 x 98 mm (L x B)</li> <li>• Montageverpackung</li> </ul>	<p><b>FOLDING PEDAL</b></p> <ul style="list-style-type: none"> <li>• PP body</li> <li>• <b>boron axle</b></li> <li>• with <b>reflectors</b></li> <li>• with <b>German approval number</b></li> <li>• tread surface: 72 x 98 mm (L x W)</li> <li>• OEM</li> </ul> <p>UVP 8,90 €</p>	

















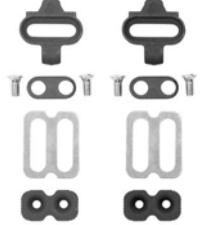

ART.-NR.	BESCHREIBUNG	DESCRIPTION	
<p><b>311013</b></p> <p>30 pair</p>	<p><b>PLATTFORM-PEDAL ›E-PC915‹</b></p> <ul style="list-style-type: none"> <li>• Design-Aluminium-Körper</li> <li>• gedichtete, CNC-gefräste CrMo-Achse</li> <li>• mit gedichtetem Industriekugellager und hochwertigem Gleitlager</li> <li>• mit austauschbaren Pins</li> <li>• nur <b>282 g</b>/Paar</li> <li>• Trittfläche: 100 x 95 mm (L x B)</li> <li>• in Exustar Einzelkarton</li> </ul>	<p><b>FLAT PEDAL ›E-PC915‹</b></p> <ul style="list-style-type: none"> <li>• design aluminium body</li> <li>• sealed, CNC machined CrMo axle</li> <li>• with sealed bearing and high quality bush bearing</li> <li>• with exchangeable pins</li> <li>• only <b>282g</b>/pair</li> <li>• tread surface: 100 x 95 mm (L x W)</li> <li>• in Exustar box</li> </ul>  <p>Tested by the manufacturer based on ISO 4210</p> <p>UVP 89,90 €</p>	<p><b>EXUSTAR</b></p> <p> <b>282 g</b></p>  <p>16 mm</p>
<p><b>311346</b> schwarz</p> <p><b>311349</b> pink</p> <p><b>311350</b> blau</p> <p><b>311351</b> grün</p> <p>30 pair</p>	<p><b>PLATTFORM-PEDAL ›E-PB525‹</b></p> <ul style="list-style-type: none"> <li>• Design-Aluminium-Körper</li> <li>• titanfarbene, gedichtete, CNC-gefräste CrMo-Achse</li> <li>• mit gedichtetem Industriekugellager und hochwertigem Gleitlager</li> <li>• mit austauschbaren Pins</li> <li>• nur <b>358 g</b>/Paar</li> <li>• Trittfläche: 95 x 100 mm (L x B)</li> <li>• in Exustar Eurolochbox</li> </ul>	<p><b>FLAT PEDAL ›E-PB525‹</b></p> <ul style="list-style-type: none"> <li>• design aluminium body</li> <li>• titanium coloured, sealed, CNC machined CrMo axle</li> <li>• with sealed bearing and high quality bush bearing</li> <li>• with interchangeable pins</li> <li>• only <b>358 g</b>/pair</li> <li>• tread surface: 95 x 100 mm (L x W)</li> <li>• in Exustar eurohole box</li> </ul> <p>black</p> <p>pink</p> <p>blue</p> <p>green</p>  <p>Tested by the manufacturer based on ISO 4210</p> <p>UVP 84,90 €</p>	<p><b>EXUSTAR</b></p> <p> <b>358 g</b></p> 
<p><b>311741</b></p> <p>40 set</p>	<p><b>ERSATZPINS</b></p> <ul style="list-style-type: none"> <li>• mit Werkzeug zur De-/Montage</li> <li>• M4-Gewinde</li> <li>• passend für Art. 311346, ...</li> <li>• 40 Stück in Blisterverpackung</li> </ul>	<p><b>REPLACEMENT PINS</b></p> <ul style="list-style-type: none"> <li>• with tool for de-/mounting</li> <li>• M4 thread</li> <li>• suitable for art. 311346, ...</li> <li>• 40 pcs in blister packaging UVP 11,90 €</li> </ul>	
<p><b>TRAIL / ENDURO</b></p> <p><b>4</b> <b>140 kg</b></p> <p><b>NEW</b></p> <p>• <b>311130</b> 50 pair</p> <p><b>313340</b> 40 pair</p> <p>• <b>311131</b> 50 pair</p> <p><b>NEW</b></p> <p><b>313341</b> 40 pair</p>	<p><b>PLATTFORM-PEDAL ›FREEDOM SL‹</b></p> <ul style="list-style-type: none"> <li>• CNC gefräster Aluminiumkörper</li> <li>• CNC gefräste CrMo-Achse</li> <li>• mit Industriekugellager</li> <li>• Montage auch mit Innensechskant möglich</li> <li>• mit austauschbaren Pins</li> <li>• gemäß <b>ISO 4210</b>: erhöhte Anforderungen bis <b>140 kg</b></li> <li>• nur <b>297 g</b>/Paar</li> <li>• Trittfläche: 96 x 91 mm (L x B)</li> </ul> <p><b>schwarz</b></p> <p>Montageverpackung</p> <p>auf M-Wave Eurolochkarte</p> <p><b>titan grau</b></p> <p>Montageverpackung</p> <p>auf M-Wave Eurolochkarte</p>	<p><b>FLAT PEDAL ›FREEDOM SL‹</b></p> <ul style="list-style-type: none"> <li>• CNC machined aluminium body</li> <li>• CNC machined CrMo axle</li> <li>• with sealed bearing</li> <li>• mounting also possible with allen key</li> <li>• with interchangeable pins</li> <li>• based on <b>ISO 4210</b>: increased requirements up to <b>140 kg</b></li> <li>• only <b>297 g</b>/pair</li> <li>• tread surface: 96 x 91 mm (L x W)</li> </ul> <p><b>black</b></p> <p>OEM</p> <p>on M-Wave eurohole card</p> <p><b>titan grey</b></p> <p>OEM</p> <p>on M-Wave eurohole card</p>  <p>Tested by the manufacturer based on ISO 4210</p> <p>UVP 39,90 €</p>	<p> <b>297 g</b></p> <p><b>M-WAVE</b></p>  <p>16 mm</p> 

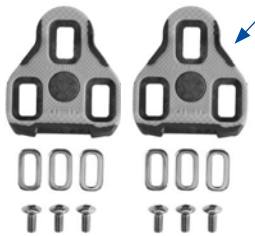
ART.-NR. 	BESCHREIBUNG	DESCRIPTION	
<b>311132</b> <b>NEW</b> <b>313350</b> 40 pair	<b>PLATTFORM-PEDAL ›FREEDOM CS‹</b> <ul style="list-style-type: none"> <li>• <b>sehr großer und stabiler Nylonkörper</b></li> <li>• besonders <b>große XXL-Trittläche:</b> <b>120 x 110 mm</b> (L x B)</li> <li>• <b>CrMo-Achse</b></li> <li>• mit <b>2 gedichteten Industriekugellagern</b></li> <li>• mit <b>austauschbaren Pins</b></li> <li>• nur <b>328 g/</b>Paar</li> </ul> Montageverpackung auf M-Wave Eurolochkarte	<b>FLAT PEDAL ›FREEDOM CS‹</b> <ul style="list-style-type: none"> <li>• <b>very large and stable nylon body</b></li> <li>• extra wide <b>XXL tread surface:</b> <b>120 x 110 mm</b> (L x W)</li> <li>• <b>CrMo axle</b></li> <li>• with <b>2 sealed bearings</b></li> <li>• with <b>exchangeable pins</b></li> <li>• only <b>328 g/</b>pair</li> </ul> OEM on M-Wave eurohole card 	   <p><b>XXL</b></p> <p> <b>328 g</b></p> <p></p> <p></p> <p>120 mm</p> <p>110 mm</p> <p>UVP 24,90 €</p>
<b>311531</b> <b>311532</b> 50 pair	<b>PLATTFORM-PEDAL ›STEADY FLAT 3‹</b> <ul style="list-style-type: none"> <li>• <b>Aluminiumkörper</b></li> <li>• Montage auch mit Innensechskant möglich</li> <li>• mit <b>hochwertigem Polymer-Gleitlager</b></li> <li>• mit austauschbaren Pins</li> <li>• mit <b>Reflektoren</b></li> <li>• mit <b>deutschem Prüfzeichen</b></li> <li>• nur 397 g/</li> <li>• Trittfläche: 93 x 97 mm (L x B)</li> </ul> Montageverpackung auf M-Wave Eurolochkarte	<b>FLAT PEDAL ›STEADY FLAT 3‹</b> <ul style="list-style-type: none"> <li>• <b>aluminium body</b></li> <li>• mounting also possible with allen key</li> <li>• with <b>high quality polymer</b> plain bearing</li> <li>• with interchangeable pins</li> <li>• with <b>reflectors</b></li> <li>• with <b>German approval number</b></li> <li>• only 397 g/</li> <li>• tread surface: 93 x 97 mm (L x W)</li> </ul> OEM on M-Wave eurohole card	  <p> <b>397 g</b></p> <p></p> <p></p> <p>UVP 24,90 €</p>
<b>311133</b> <b>NEW</b> <b>313315</b> 40 pair	<b>PLATTFORM-PEDAL ›FLAT‹</b> <ul style="list-style-type: none"> <li>• <b>Aluminiumkörper</b></li> <li>• <b>gedichtete</b> Achse</li> <li>• mit <b>hochwertigem Polymer-Gleitlager</b></li> <li>• mit austauschbaren Pins</li> <li>• nur 398 g/</li> <li>• Trittfläche: 105 x 94 mm (L x B)</li> </ul> Montageverpackung auf M-Wave Eurolochkarte	<b>FLAT PEDAL ›FLAT‹</b> <ul style="list-style-type: none"> <li>• <b>aluminium body</b></li> <li>• <b>sealed axle</b></li> <li>• with <b>high quality polymer</b> plain bearing</li> <li>• with exchangeable pins</li> <li>• only 398 g/</li> <li>• tread surface: 105 x 94 mm (L x W)</li> </ul> OEM on M-Wave eurohole card	   <p> <b>398 g</b></p> <p></p> <p>21 mm</p> <p>UVP 19,90 €</p>
<b>312014</b> <b>311134</b> <b>NEW</b> 50 pair	<b>PLATTFORM-PEDAL</b> <ul style="list-style-type: none"> <li>• <b>Aluminiumkörper</b></li> <li>• <b>Boron-Achse</b></li> <li>• Montage mit <b>Innen- und Außen-sechskantschlüssel</b> möglich</li> <li>• mit <b>hochwertigem Polymer-Gleitlager</b></li> <li>• mit <b>Reflektoren</b></li> <li>• mit <b>deutschem Prüfzeichen</b></li> <li>• Trittfläche: 84 x 90 mm (L x B)</li> </ul> Montageverpackung auf M-Wave Eurolochkarte	<b>FLAT PEDAL</b> <ul style="list-style-type: none"> <li>• <b>aluminium body</b></li> <li>• <b>boron axle</b></li> <li>• mounting possible with <b>allen key</b> and <b>open hex wrench</b></li> <li>• with <b>high quality polymer</b> plain bearing</li> <li>• with <b>reflectors</b></li> <li>• with <b>German approval number</b></li> <li>• tread surface: 84 x 90 mm (L x W)</li> </ul> OEM on M-Wave eurohole card	  <p></p> <p></p> <p>UVP 11,90 €</p>
<b>311348</b> <b>311332</b> <b>311330</b> 50 pair	<b>PLATTFORM-PEDAL</b> <ul style="list-style-type: none"> <li>• <b>Aluminiumkörper</b></li> <li>• Trittfläche: 87 x 94 mm (L x B)</li> <li>• Montageverpackung</li> </ul> 1/16" Achse, schwarz 1/16" Achse, silber 1/2" Achse, silber	<b>FLAT PEDAL</b> <ul style="list-style-type: none"> <li>• <b>aluminium body</b></li> <li>• tread surface: 87 x 94 mm (L x W)</li> <li>• OEM</li> </ul> 1/16" axle, black 1/16" axle, silver 1/2" axle, silver	  <p>UVP 6,90 €</p>

ART.-NR.	BESCHREIBUNG	DESCRIPTION	
<p><b>311135</b></p> <p><b>NEW</b></p> <p><b>311380</b></p> <p>50 pair</p>	<p><b>BMX-PEDAL</b></p> <ul style="list-style-type: none"> <li>aus <b>Polycarbonat</b></li> <li>Trittläche: 95 x 104 mm (L x B)</li> </ul> <p>Montageverpackung</p> <p>auf M-Wave Eurolochkarte</p>	<p><b>BMX PEDAL</b></p> <ul style="list-style-type: none"> <li><b>polycarbonate</b> body</li> <li>tread surface: 95 x 104 mm (L x W)</li> </ul> <p>OEM</p> <p>on M-Wave eurohole card</p> <p><small>Tested by the manufacturer based on ISO 4210</small></p> <p>UVP 8,90 €</p>	
<p><b>313180</b></p> <p><b>313181</b></p> <p>50 pair</p>	<p><b>PLATTFORM-PEDAL</b></p> <ul style="list-style-type: none"> <li>Kunststoffkörper</li> <li><b>anatomisch</b> geformte, konkave Auflagefläche</li> <li><b>CrMo</b>-Achse</li> <li>mit 2 <b>Kugellagern</b></li> <li>mit <b>deutschem Prüfzeichen</b></li> <li>mit <b>Reflektoren</b></li> <li>Montage auch mit <b>Innensechskant</b> möglich</li> <li><b>XL</b>-Trittläche: 106 x 101 mm (L x B)</li> </ul> <p>Montageverpackung</p> <p>auf M-Wave Eurolochkarte</p>	<p><b>FLAT PEDAL</b></p> <ul style="list-style-type: none"> <li>plastic body</li> <li><b>anatomically</b> shaped concave supporting surface</li> <li><b>CrMo</b> axle</li> <li>with 2 <b>ball bearings</b></li> <li>with <b>German approval number</b></li> <li>with <b>reflectors</b></li> <li>mounting also possible with <b>allen key</b></li> <li><b>XL</b> tread surface: 106 x 101 mm (L x W)</li> </ul> <p>OEM</p> <p>on M-Wave eurohole card</p> <p><small>Tested by the manufacturer based on ISO 4210</small></p> <p>UVP 5,90 €</p>	
<p><b>313310</b></p> <p><b>311136</b></p> <p><b>NEW</b></p> <p><b>313311</b></p> <p><b>311137</b></p> <p><b>NEW</b></p> <p>50 pair</p>	<p><b>PLATTFORM-PEDAL</b></p> <ul style="list-style-type: none"> <li>Kunststoffkörper</li> <li>mit 2 <b>Kugellagern</b></li> <li>mit <b>Reflektoren</b></li> <li>Trittläche: <b>96 x 95 mm</b> (L x B)</li> </ul> <p>9/16" Achse</p> <p>Montageverpackung</p> <p>auf M-Wave Eurolochkarte</p> <p>1/2" Achse</p> <p>Montageverpackung</p> <p>auf M-Wave Eurolochkarte</p> <p>Ohne deutsches Prüfzeichen - Verkauf und Nutzung im Geltungsbereich der StVZO (Deutschland) unzulässig (Abgabe nur an außerdeutsche Kunden).</p>	<p><b>FLAT PEDAL</b></p> <ul style="list-style-type: none"> <li>plastic body</li> <li>with 2 <b>ball bearings</b></li> <li>with <b>reflectors</b></li> <li>tread surface: <b>96 x 95 mm</b> (L x W)</li> </ul> <p>9/16" axle</p> <p>OEM</p> <p>on M-Wave eurohole card</p> <p>1/2" axle</p> <p>OEM</p> <p>on M-Wave eurohole card</p> <p>UVP 4,90 €</p>	
<p><b>311292</b></p> <p>50 pair</p>	<p><b>RENNRADPEDAL</b></p> <p><b>›SYLVAN ROAD BLACK‹</b></p> <ul style="list-style-type: none"> <li><b>sehr hochwertig</b></li> <li><b>Aluminiumkörper</b> und -käfig</li> <li>nur <b>337 g</b></li> <li>von <b>MKS (Japan)</b> hergestellt</li> <li>Trittläche: 61 x 102 mm (L x B)</li> <li>Montageverpackung</li> </ul>	<p><b>ROAD PEDAL</b></p> <p><b>›SYLVAN ROAD BLACK‹</b></p> <ul style="list-style-type: none"> <li><b>very high quality</b></li> <li><b>aluminium body</b> and cage</li> <li>only <b>337 g</b></li> <li>manufactured by <b>MKS (Japan)</b></li> <li>tread surface: 61 x 102 mm (L x W)</li> <li>OEM</li> </ul> <p><small>Tested by the manufacturer based on ISO 4210</small></p> <p>UVP 47,90 €</p>	<p><b>MADE IN JAPAN</b></p> 
<p><b>313461</b></p> <p><b>311138</b></p> <p><b>NEW</b></p> <p>50 pair</p>	<p><b>RENNRADPEDAL</b></p> <ul style="list-style-type: none"> <li><b>Aluminiumkörper</b> und -käfig</li> <li><b>CrMo</b>-Achse</li> <li>Pedalhaken nachrüstbar</li> <li>Trittläche: 62 x 96 mm (L x B)</li> </ul> <p>Montageverpackung</p> <p>auf M-Wave Eurolochkarte</p>	<p><b>ROAD PEDAL</b></p> <ul style="list-style-type: none"> <li><b>aluminium body</b> and cage</li> <li><b>CrMo</b> axle</li> <li>toe clips attachable</li> <li>tread surface: 62 x 96 mm (L x W)</li> </ul> <p>OEM</p> <p>on M-Wave eurohole card</p> <p>UVP 10,90 €</p>	

ART.-NR. 	BESCHREIBUNG	DESCRIPTION	
<b>313127</b> 50 set	<b>PEDALHAKEN</b> <ul style="list-style-type: none"> <li>• mit Riemen und Befestigungsteilen</li> <li>• Universalgröße: M / L</li> <li>• Set im Polybeutel</li> </ul>	<b>TOE CLIPS</b> <ul style="list-style-type: none"> <li>• with pedal straps and mounting parts</li> <li>• universal size: M / L</li> <li>• set in PE bag</li> </ul>	 <p>UVP 5,90 €</p>
<b>313137</b> 300 pair	<b>PEDALRIEMEN</b> 1 Paar im Polybeutel	<b>PEDAL STRAPS</b> 1 pair in PE bag	 <p>UVP 2,90 €</p>
<b>313126</b> 100 pair	<b>PEDALHAKEN</b> <ul style="list-style-type: none"> <li>• kurze Ausführung</li> <li>• Benutzung <b>ohne Riemen möglich</b></li> <li>• mit Befestigungsteilen</li> <li>• Universalgröße: M / L</li> <li>• Montageverpackung</li> </ul>	<b>TOE CLIPS</b> <ul style="list-style-type: none"> <li>• short design</li> <li>• usage <b>without straps possible</b></li> <li>• with mounting parts</li> <li>• universal size: M / L</li> <li>• OEM</li> </ul>	 <p>UVP 4,90 €</p>
<b>313702</b> 200/4 set	<b>PEDALREFLEKTOREN</b> <ul style="list-style-type: none"> <li>• verpackt zu <b>4 Stück im Set</b></li> <li>• mit Schrauben und Muttern</li> </ul> <p>Ohne deutsches Prüfzeichen - Verkauf und Nutzung im Geltungsbereich der StVZO (Deutschland) unzulässig (Abgabe nur an außerdeutsche Kunden).</p>	<b>PEDAL REFLECTORS</b> <ul style="list-style-type: none"> <li>• <b>4 pieces</b> packed in one set</li> <li>• with screws and nuts</li> </ul> <p>UVP 2,90 €</p>	
<b>122900</b> 150/5 pair	<b>PEDALTASCHE</b> ›ROTTERDAM PEDAL P‹ <ul style="list-style-type: none"> <li>• <b>2 Taschen für 1 Paar Pedale</b></li> <li>• aus Neopren</li> <li>• als <b>Transporttaschen oder zum Schutz am Rad</b> verwendbar</li> <li>• ca. 135 x 145 mm</li> <li>• 1 Paar auf M-Wave Eurolochkarte</li> </ul>	<b>PEDAL BAG</b> ›ROTTERDAM PEDAL P‹ <ul style="list-style-type: none"> <li>• <b>2 bags for 1 pair of pedals</b></li> <li>• made of neoprene</li> <li>• suitable as <b>transport bags or as protection on the bike</b></li> <li>• approx. 135 x 145 mm</li> <li>• 1 pair on M-Wave eurohole card</li> </ul> <p>UVP 10,90 €</p>	  



ART.-NR.	BESCHREIBUNG	DESCRIPTION	
          <b>311796</b> 100 set	<p><b>SCHUHPLATTEN-SET</b></p> <ul style="list-style-type: none"> <li>• Shimano kompatibel (kein original Shimano Ersatzteil)</li> <li>• passend für Klick-Pedale Art. 311099/310/804/11/35/47/49/52/64/66/67/2060/1/2, ...</li> <li>• mit Befestigungsteilen</li> </ul> <p>›E-C05F‹ paarweise in Exustar Blisterverpackung</p>	<p><b>CLEAT SET</b></p> <ul style="list-style-type: none"> <li>• Shimano compatible (no original Shimano spare part)</li> <li>• suitable for clipless pedals art. 311099/310/804/11/35/47/49/52/64/66/67/2060/1/2, ...</li> <li>• with mounting parts</li> </ul> <p>›E-C05F‹ one pair in Exustar blister packaging</p> <p style="text-align: right;">UVP 12,90 €</p>	  
<b>311812</b> 100 set	<p>›Cleat S‹ paarweise in M-Wave Blisterverpackung</p>	<p>›Cleat S‹ one pair in M-Wave blister packaging</p> <p style="text-align: right;">UVP 9,90 €</p>	  
<b>311758</b> 100/25 set          <b>311896</b> 100/25 set	<p><b>SCHUHPLATTEN-SET</b></p> <ul style="list-style-type: none"> <li>• Look Keo kompatibel</li> <li>• mit <b>Non-Slip</b> Auflage</li> <li>• passend für Art. 311821/53/55, 313451, ...</li> <li>• mit Befestigungsteilen</li> <li>• paarweise in Exustar Blisterverpackung</li> </ul> <p>›E-ARC11+‹ <b>7° seitliche Bewegungsfreiheit</b></p> <p>›E-BLK 11+‹ <b>fixe Positionierung</b></p>	<p><b>CLEAT SET</b></p> <ul style="list-style-type: none"> <li>• Look Keo compatible</li> <li>• with <b>non-slip</b> layer</li> <li>• suitable for art. 311821/53/55, 313451, ...</li> <li>• with mounting parts</li> <li>• one pair in Exustar blister packaging</li> </ul> <p>›E-ARC11+‹ <b>7° lateral tolerance</b></p> <p>›E-BLK 11+‹ <b>fixed position</b></p> <p style="text-align: right;">UVP 13,90 €</p>	   
<b>311786</b> 100/25 set	<p><b>SCHUHPLATTEN-SET</b></p> <ul style="list-style-type: none"> <li>• Look Keo kompatibel</li> <li>• mit Befestigungsteilen</li> <li>• passend für Art. 311821/53/55, 313451, ...</li> </ul> <p>›E-ARC 10‹ <b>7° seitliche Bewegungsfreiheit</b></p> <p>• paarweise in Exustar Blisterverpackung</p>	<p><b>CLEAT SET</b></p> <ul style="list-style-type: none"> <li>• Look Keo compatible</li> <li>• with mounting parts</li> <li>• suitable for art. 311821/53/55, 313451, ...</li> </ul> <p>›E-ARC 10‹ <b>7° lateral tolerance</b></p> <p>• one pair in Exustar blister packaging</p> <p style="text-align: right;">UVP 11,90 €</p>	  
<b>311836</b> 100 set	<p>›Cleat L‹ <b>5° seitliche Bewegungsfreiheit</b></p> <p>• paarweise in M-Wave Blisterverpackung</p>	<p>›Cleat L‹ <b>5° lateral tolerance</b></p> <p>• one pair in M-Wave blister packaging</p> <p style="text-align: right;">UVP 9,90 €</p>	  



**NOVATEC®**  
QUALITY • PERFORMANCE • RELIABILITY

**LEICHT WIE EINE FEDER - STARK WIE EIN OCHSE  
LIGHT AS A FEATHER - STRONG AS AN OX**

Leicht, zuverlässig, innovativ. Qualitativ hochwertig, ansprechender Look, ein attraktiver Preis. Die Wahrnehmung von Novatec im Markt könnte nicht besser sein. Und das wissen auch zahlreiche renommierte Erstausrüster zu schätzen, für die Novatec Naben produziert.

Lightweight, reliable and innovative. High quality, appealing look and attractive price. The perception of Novatec could not be better in the market. Numerous renowned original equipment manufacturer – for which Novatec hubs are produced – will appreciate this.



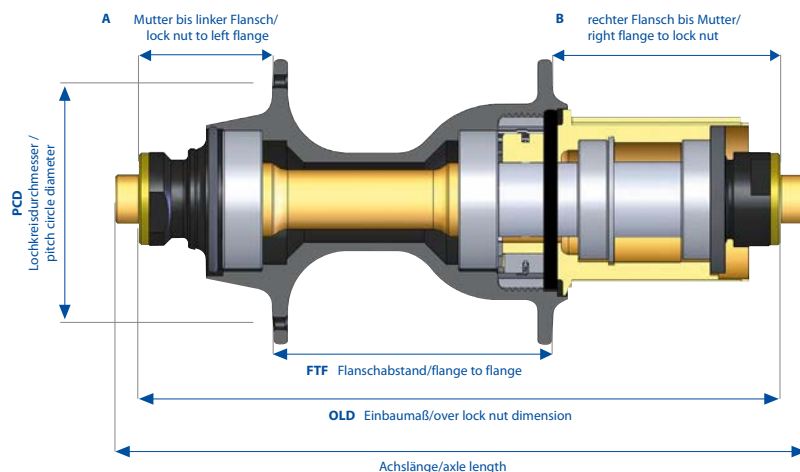

## ULTRALIGHT

## CARBON

## ULTRALIGHT

### VORDERRADSCHWIBEN- BREMSNABE ›D411CB‹

- **UD-Carbon Straight Pull-** Scheibenbremsnabe
- **2 japanische Industriekugellager**
- **4 in 1:** serienmäßig vorbereitet für 15 mm Steckachse, Umrüstset für Schnellspanner 5 mm (Art. 320290), 9 mm und 12 mm (Art. 320107) optional erhältlich
- vom Hersteller empfohlen für Rennrad und Cyclocross
- nur **79 g**
- Einbaumaß: 100 mm
- PCD 34 mm, FTF 63,6 mm, Offset: 3,2 mm
- im Novatec Einzelkarton

**326378** 28 Loch  
**326391** 24 Loch  
30

### FRONT DISC BRAKE HUB ›D411CB‹

- **UD carbon straight pull** disc brake hub
- **2 Japanese sealed bearings**
- **4 in 1:** standard fitted for 15 mm thru axle, conversion kit for QR 5 mm (art. 320290), 9 mm and 12 mm (art. 320107) optionally available
- recommended by the manufacturer for roadbike und cyclocross
- only **79 g**
- OLD: 100 mm
- PCD 34 mm, FTF 63.6 mm, Offset: 3.2 mm
- in Novatec box

28 hole  
24 hole

UVP 129,00 €

4 IN 1



CARBON



**320290** 100 set Ausgleichshülsen für 5 mm Schnellspanner  
**320107** 200 set Ausgleichshülsen für 12 mm Schnellspanner

spacers for 5 mm quick release  
spacers for 12 mm quick release  
UVP 11,90 €

### HINTERRADSCHWIBEN- BREMSNABE ›D412CB‹

- **UD-Carbon Straight Pull-** Scheibenbremsnabe
- **4 Industriekugellager**
- **4 in 1:** serienmäßig vorbereitet für 12 x 142 mm-Steckachse, Umrüstset für Schnellspanner 5 mm (Art. 320291), 10 x 135 mm, 12 x 135 mm optional erhältlich
- für 10- und 11-fach (Shimano Road und MTB)
- umrüstbar auf Sram XD Drive durch Kassettenkörper Art. 326293 und für 12-fach Sram-Kassetten durch XD und XDR Drive Kassettenfreilaufkörper Art. 326272
- nur **229 g**
- Einbaumaß: 142 mm
- PCD 34/47 mm, FTF 68 mm, Offset: 6,3 mm
- im Novatec Einzelkarton

**326379** 28 Loch  
**326392** 24 Loch  
30

### REAR DISC BRAKE HUB ›D412CB‹

- **UD carbon straight pull** disc brake hub
- **4 sealed bearings**
- **4 in 1:** standard fitted for 12 x 142 mm thru axle, conversion kit for QR 5 mm (art. 320291), 10 x 135 mm, 12 x 135 mm optionally available
- for 10 and 11 speed (Shimano Road and MTB)
- convertibel to Sram XD Drive by cassette body art. 326293 and for 12 speed Sram cassettes by XD and XDR Drive cassette body art. 326272
- only **229 g**
- OLD: 142 mm
- PCD 34/47 mm, FTF 68 mm, Offset: 6.3 mm
- in Novatec box

28 hole  
24 hole

UVP 185,00 €

4 IN 1













CARBON















**320291** 30 set Umrüstset für 5 x 135 mm Schnellspanner

conversion kit for 5 x 135 mm quick release  
UVP 19,90 €





# SCHEIBENBREMSNABEN DISC BRAKE HUBS

ART.-NR.	BESCHREIBUNG	DESCRIPTION	
			<b>SUPERLIGHT</b> <b>FRONT</b> <b>SUPERLIGHT</b>
	<p><b>VORDERRADSCHIBEN-BREMSNABE ›D791SB/A‹</b></p> <ul style="list-style-type: none"> <li>• 32 Loch</li> <li>• <b>4 in 1:</b> ausgestattet mit <b>5 mm Aluminium Schnellspanner</b>, optional umrüstbar durch Ausgleichshülsen für 9 mm (Art. 320118) Schnellspanner, 12 mm (Art. 320119) und 15 mm (Art. 320120) Steckachse</li> <li>• <b>2 japanische Industriekugellager</b></li> <li>• Aluminium-Achse</li> <li>• nur <b>157 g</b> (ohne Schnellspanner)</li> <li>• Einbaumaß: 100 mm</li> <li>• PCD: 58/45 mm, FTF: 62 mm</li> <li>• A: 26,2 mm, B: 11,8 mm</li> <li>• im Novatec Einzelkarton</li> </ul>	<p><b>FRONT DISC BRAKE HUB ›D791SB/A‹</b></p> <ul style="list-style-type: none"> <li>• 32 hole</li> <li>• <b>4 in 1:</b> equipped with <b>5 mm aluminium quick release</b>, optionally convertible through spacers to 9 mm (art. 320118) QR, 12 mm (art. 320119) and 15 mm (art. 320120) thru axle</li> <li>• <b>2 Japanese sealed bearings</b></li> <li>• aluminium axle</li> <li>• only <b>157 g</b> (w/o quick release)</li> <li>• OLD: 100 mm</li> <li>• PCD: 58/45 mm, FTF: 62 mm</li> <li>• A: 26.2 mm, B: 11.8 mm</li> <li>• in Novatec box</li> </ul>	<p><b>4 IN 1</b></p>  <p>157 g</p>  <p>Japan</p>  
<b>326420</b> 30	schwarz eloxiert	black anodised	
<b>326423</b> 30	rot eloxiert	red anodised	UVP 74,90 €
<b>326417</b> 30	<ul style="list-style-type: none"> <li>• <b>32 Loch</b></li> <li>• <b>4 in 1:</b> vorbereitet für <b>15 mm Steckachse</b>, optional umrüstbar durch Ausgleichshülsen auf 5 mm (Art. 320117), 9 mm (Art. 320118) Schnellspanner und 12 mm (Art. 320119) Steckachse</li> <li>• nur <b>141 g</b> (ohne Steckachse)</li> </ul>	<ul style="list-style-type: none"> <li>• <b>32 hole</b></li> <li>• <b>4 in 1:</b> prepared for <b>15 mm thru axle</b>, optionally convertible through spacers to 5 mm (art. 320117), 9 mm (art. 320118) QR and 12 mm (art. 320119) thru axle</li> <li>• only <b>141 g</b> (w/o thru axle)</li> </ul>	 <p>141 g</p>  <p>15 mm</p>
			UVP 64,90 €
<b>326416</b> 30	<ul style="list-style-type: none"> <li>• <b>24 Loch</b></li> <li>• <b>4 in 1:</b> vorbereitet für <b>12 mm Steckachse</b>, optional umrüstbar durch Ausgleichshülsen für 5 mm (Art. 320117) oder 9 mm (Art. 320118) Schnellspanner und 15 mm (Art. 320120) Steckachse</li> <li>• nur <b>141 g</b> (ohne Steckachse)</li> </ul>	<ul style="list-style-type: none"> <li>• <b>24 hole</b></li> <li>• <b>4 in 1:</b> prepared for <b>12 mm thru axle</b>, optionally convertible through spacers to 5 mm (art. 320117) or 9 mm (art. 320118) QR and 15 mm thru axle (art. 320120)</li> <li>• only <b>141 g</b> (w/o thru axle)</li> </ul>	 <p>141 g</p>  <p>12 mm</p>
			UVP 64,90 €
<b>326448</b> 30	<ul style="list-style-type: none"> <li>• <b>28 Loch</b></li> <li>• <b>4 in 1:</b> vorbereitet für <b>12 mm Steckachse</b>, optional umrüstbar durch Ausgleichshülsen für 5 mm (Art. 320280) oder 9 mm Schnellspanner und für 15 mm Steckachse</li> <li>• für <b>Centerlock</b> Bremsscheiben</li> <li>• nur <b>141 g</b> (ohne Steckachse)</li> </ul>	<ul style="list-style-type: none"> <li>• <b>28 hole</b></li> <li>• <b>4 in 1:</b> prepared for <b>12 mm thru axle</b>, optionally convertible through spacers to 5 mm (art. 320280) or 9 mm QR and to 15 mm thru axle</li> <li>• for <b>centerlock</b> brake discs</li> <li>• only <b>141 g</b> (w/o thru axle)</li> </ul>	<p><b>CENTERLOCK</b></p>  <p>141 g</p>  <p>12 mm</p> 
			UVP 64,90 €
	Ausgleichshülsen für Nabenmodell D791SB	spacers for hub type D791SB	
<b>320117</b> 30 set	für 5 mm Schnellspanner	for 5 mm quick release	
<b>320118</b> 20 set	für 9 mm Schnellspanner	for 9 mm quick release	
<b>320119</b> 100 set	für 12 mm Schnellspanner	for 12 mm quick release	
<b>320120</b> 100 set	für 15 mm Steckachse	for 15 mm thru axle	
			UVP 11,90 €





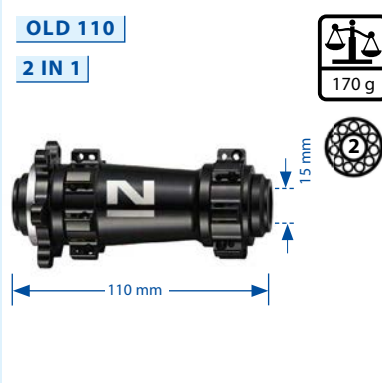

ART.-NR.	BESCHREIBUNG	DESCRIPTION	
<b>SUPERLIGHT</b>		<b>REAR</b>	<b>SUPERLIGHT</b>
	<p><b>HINTERRADSCHIBEN-BREMSNABE ›D792SB/A-AA‹</b></p> <ul style="list-style-type: none"> <li>• 32 Loch</li> <li>• <b>4 in 1:</b> ausgestattet mit 5 mm Aluminium-Schnellspanner, optional umrüstbar durch Umrüstsets für 10 mm (Art. 320079), 12 mm (Art. 320080) und X12 Steckachse (Art. 320081)</li> <li>• <b>4 japanische Industriekugellager</b></li> <li>• Aluminium-Achse</li> <li>• kompatibel mit Shimano 8-11-fach (MTB+Road)</li> <li>• umrüstbar auf Sram XD Drive durch Kassettenkörper Art. 326293 und für 12-fach Sram-Kassetten durch XD und XDR Drive Kassettenkörper Art. 326272</li> <li>• nur <b>269 g</b> (ohne Schnellspanner)</li> <li>• Einbaumaß: 135 mm</li> <li>• PCD: 58/49 mm, FTF: 56,4 mm A: 31,5 mm, B: 47,1 mm</li> <li>• im Novatec Einzelkarton</li> </ul>	<p><b>REAR DISC BRAKE HUB ›D792SB/A-AA‹</b></p> <ul style="list-style-type: none"> <li>• 32 hole</li> <li>• <b>4 in 1:</b> equipped with aluminium quick release (5 mm), optionally convertible through spacers to 10 mm thru axle (art. 320079), 12 mm thru axle (art. 320080) and X12 thru axle (art. 320081)</li> <li>• <b>4 Japanese sealed bearings</b></li> <li>• aluminium axle</li> <li>• compatible with Shimano 8-11speed (MTB+Road)</li> <li>• convertible to Sram XD Drive by cassette body art. 326293 and for 12 speed Sram cassettes by XD and XDR Drive cassette body art. 326272</li> <li>• only <b>269 g</b> (w/o quick release)</li> <li>• OLD: 135 mm</li> <li>• PCD: 58/49 mm, FTF: 56.4 mm A: 31.5 mm, B: 47.1 mm</li> <li>• in Novatec box</li> </ul>	<p><b>4 IN 1</b></p>      <p>UVP 137,00 €</p>
<b>326450</b>	schwarz eloxiert	black anodised	
<b>326453</b>	rot eloxiert	red anodised	
30			
	<ul style="list-style-type: none"> <li>• <b>4 in 1:</b> vorbereitet für <b>12 x 142 mm Steckachse</b>, optional umrüstbar durch Ausgleichshülsen auf 5 mm Schnellspanner (Art. 320112) und 10 mm Steckachse (Art. 320079) sowie 12 x 135 mm Steckachse (Art. 320080)</li> <li>• Einbaumaß: 142 mm</li> </ul> <p>Kassettenfreilaufkörper passend für Shimano 8-11-fach (MTB + Road)</p>	<ul style="list-style-type: none"> <li>• <b>4 in 1:</b> prepared for <b>12 x 142 mm thru axle</b>, optionally convertible through spacers to 5 mm quick release (art. 320112) and 10 mm thru axle (art. 320079) as well as 12 x 135 mm thru axle (art. 320080)</li> <li>• OLD: 142 mm</li> </ul> <p>cassette body suitable for Shimano 8-11speed (MTB+Road)</p>	
<b>326460</b>	32 Loch	32 hole	
20			
<b>326473</b>	24 Loch	24 hole	
30			
<b>326449</b>	<ul style="list-style-type: none"> <li>• 28 Loch</li> <li>• für <b>Centerlock</b> Bremsscheiben</li> <li>• optional umrüstbar durch Ausgleichshülsen auf 5 mm Schnellspanner (Art. 320282)</li> </ul>	<ul style="list-style-type: none"> <li>• 28 hole</li> <li>• for <b>centerlock</b> brake discs</li> <li>• optionally convertible through spacers to 5 mm quick release (art. 320282)</li> </ul> <p>UVP 132,00 €</p>	<p><b>CENTERLOCK</b></p> 
<b>326463</b>	<ul style="list-style-type: none"> <li>• 32 Loch</li> <li>• Kassettenfreilaufkörper passend für <b>Sram</b>, mit XD Drive für XX1, silber (Ersatzkassettenfreilaufkörper Art. 326293)</li> </ul>	<ul style="list-style-type: none"> <li>• 32 hole</li> <li>• cassette body suitable for <b>Sram</b>, with XD Drive for XX1, silver (replacement cassette body art. 326293)</li> </ul> <p>UVP 128,00 €</p>	
20			
	Umrüstsets für Nabenmodell D792SB	spacers for hub type D792SB	
<b>320112</b>	Umrüstset, CrMo, für 5 mm Schnellspanner	conversion kit, CrMo, for 5 mm QR	 <p>UVP 19,90 €</p>
<b>320079</b>	Umrüstset, CrMo, für 10 mm Steckachse, mit Schnellspanner	conversion kit, CrMo, for 10 mm thru axle, with QR	 <p>UVP 29,90 €</p>
<b>320080</b>	Umrüstset, CrMo, für 12 mm Steckachse, Einbaumaß: 135 mm	conversion kit, CrMo, for 12 mm thru axle, OLD: 135 mm	 <p>UVP 19,90 €</p>
50 set			
<b>320081</b>	Umrüstset, CrMo, für X12 Steckachse, Einbaumaß: 142 mm	conversion kit, CrMo, for X12 thru axle, OLD: 142 mm	 <p>UVP 19,90 €</p>
100 set			

# SCHEIBENBREMSNABEN DISC BRAKE HUBS









ART.-NR.	BESCHREIBUNG	DESCRIPTION	
<b>ENDURO/ROAD</b>			
<b>325123</b> 30	<b>VORDERRADSCHIBEN- BREMSNABE ›D811SB-15‹</b> <ul style="list-style-type: none"> <li>• 32 Loch</li> <li>• für <b>15 mm Steckachse</b></li> <li>• <b>2 Industriekugellager</b></li> <li>• nur 173 g</li> <li>• Einbaumaß: 100 mm</li> <li>• PCD: 58/45 mm, FTF: 62 mm</li> <li>• A: 26,2 mm, B: 11,8 mm</li> <li>• im Novatec Einzelkarton</li> </ul>	<b>FRONT DISC BRAKE HUB ›D811SB-15‹</b> <ul style="list-style-type: none"> <li>• 32 hole</li> <li>• for <b>15 mm thru axle</b></li> <li>• <b>2 sealed bearings</b></li> <li>• only 173 g</li> <li>• OLD: 100 mm</li> <li>• PCD: 58/45 mm, FTF: 62 mm</li> <li>• A: 26.2 mm, B: 11.8 mm</li> <li>• in Novatec box</li> </ul>	<b>Ø 15 MM</b> 
<b>321443</b> 30	<b>HINTERRADSCHIBENBREMS- NABE ›D982TSB-X12-115‹</b> <ul style="list-style-type: none"> <li>• 32 Loch</li> <li>• für <b>12 mm Steckachse</b></li> <li>• <b>2 Industriekugellager</b></li> <li>• für 8-11(MTB)-fach Shimano Kassette</li> <li>• Einbaumaß: <b>142 mm</b></li> <li>• PCD: 58/49 mm, FTF: 63,1 mm</li> <li>• A: 35,4 mm, B: 49,3 mm</li> <li>• Montageverpackung</li> </ul>	<b>REAR DISC BRAKE HUB ›D982TSB-X12-115‹</b> <ul style="list-style-type: none"> <li>• 32 hole</li> <li>• for <b>12 mm thru axle</b></li> <li>• <b>2 sealed bearings</b></li> <li>• for 8-11(MTB) speed Shimano cassette</li> <li>• OLD: <b>142 mm</b></li> <li>• PCD: 58/49 mm, FTF: 63.1 mm</li> <li>• A: 35.4 mm, B: 49.3 mm</li> <li>• OEM</li> </ul>	<b>Ø 12 MM</b> 
<b>BOOST</b>			
<b>326500</b> 50	<b>VORDERRADSCHIBEN- BREMSNABE ›XDS641SB-B15‹</b> <ul style="list-style-type: none"> <li>• <b>Boost</b></li> <li>• Aluminium <b>Straight Pull</b></li> <li>• <b>28 Loch</b></li> <li>• für <b>15 mm Steckachse</b></li> <li>• 2 Industriekugellager</li> <li>• Gewicht: 170 g</li> <li>• Einbaumaß: <b>110 mm</b></li> <li>• PCD: 37 mm, FTF: 77,5 mm</li> <li>• Offset: 6,5 mm</li> <li>• Montageverpackung</li> </ul>	<b>FRONT DISC BRAKE HUB ›XDS641SB-B15‹</b> <ul style="list-style-type: none"> <li>• <b>Boost</b></li> <li>• aluminium <b>Straight Pull</b></li> <li>• <b>28 hole</b></li> <li>• for <b>15 mm thru axle</b></li> <li>• 2 sealed bearings</li> <li>• weight: 170 g</li> <li>• OLD: <b>110 mm</b></li> <li>• PCD: 37 mm, FTF: 77.5 mm</li> <li>• Offset: 6.5 mm</li> <li>• OEM</li> </ul>	<b>OLD 110</b> <b>2 IN 1</b> 
<b>326502</b> 32	<b>HINTERRADSCHIBENBREMS- NABE ›XDS642SB-B12-ABG‹</b> <ul style="list-style-type: none"> <li>• <b>Boost</b></li> <li>• Aluminium <b>Straight Pull</b></li> <li>• <b>28 Loch</b></li> <li>• für <b>12 mm Steckachse</b></li> <li>• <b>5 Industriekugellager</b></li> <li>• für 8-11 (MTB)-fach Shimano</li> <li>• nur 337 g</li> <li>• Kassettenfreilaufkörper mit <b>6 Sperr- klinken, Anti-Bite-Guard</b> und Ratchet Ring mit 42 Zähnen für schnelle Kraft- übertragung fast <b>ohne Verzögerung</b></li> <li>• Ersatzkassettenfreilaufkörper Shimano Art. 326296</li> <li>• umrüstbar auf Sram XD Drive durch Kassettenfreilaufkörper Art. 326286</li> <li>• Einbaumaß: <b>148 mm</b></li> <li>• Montageverpackung</li> </ul>	<b>REAR DISC BRAKE HUB ›XDS642SB-B12-ABG‹</b> <ul style="list-style-type: none"> <li>• <b>Boost</b></li> <li>• aluminium <b>Straight Pull</b></li> <li>• <b>28 hole</b></li> <li>• for <b>12 mm thru axle</b></li> <li>• <b>5 sealed bearings</b></li> <li>• for 8-11(MTB) speed Shimano</li> <li>• only 337 g</li> <li>• cassette body with <b>6 pawls, anti-bite- guard</b> and ratchet ring with 42 teeth for fast power transmission nearly <b>without delay</b></li> <li>• replacement cassette body Shimano art. 326296</li> <li>• convertible to Sram XD Drive through cassette body art. 326286</li> <li>• OLD: <b>148 mm</b></li> <li>• OEM</li> </ul>	<b>OLD 148</b> 

ART.-NR.	BESCHREIBUNG	DESCRIPTION	
<b>BOOST</b>			
326137 30	<b>VORDERRADSCHIEBEN-BREMSNABE ›D791SB-B15‹</b> <ul style="list-style-type: none"> <li>• <b>Boost</b></li> <li>• 32 Loch</li> <li>• für <b>15 mm Steckachse</b></li> <li>• 2 Industriekugellager</li> <li>• nur 146 g</li> <li>• Einbaumaß: <b>110 mm</b></li> <li>• PCD: 58/45 mm, FTF: 72 mm</li> <li>• A: 26,7 mm, B: 12,3 mm</li> <li>• im Novatec Einzelkarton</li> </ul>	<b>FRONT DISC BRAKE HUB ›D791SB-B15‹</b> <ul style="list-style-type: none"> <li>• <b>Boost</b></li> <li>• 32 hole</li> <li>• for <b>15 mm thru axle</b></li> <li>• 2 sealed bearings</li> <li>• only 146 g</li> <li>• OLD: <b>110 mm</b></li> <li>• PCD: 58/45 mm, FTF: 72 mm</li> <li>• A: 26.7 mm, B: 12.3 mm</li> <li>• in Novatec box</li> </ul>	<div style="display: flex; align-items: center;"> <div style="border: 1px solid black; padding: 2px; margin-right: 10px;">OLD 110</div> </div>
326127 30	<b>HINTERRADSCHIEBEN-BREMSNABE ›D462SB‹</b> <ul style="list-style-type: none"> <li>• <b>Boost</b></li> <li>• 32 Loch</li> <li>• für <b>12 mm Steckachse</b></li> <li>• <b>5 Industriekugellager</b></li> <li>• Kassettenfreilaufkörper mit <b>5 Sperrklinken</b> und Ratchet Ring mit 33 Zähnen für schnelle Kraftübertragung fast <b>ohne Verzögerung</b></li> <li>• nur 325 g</li> <li>• Ersatzkassettenfreilaufkörper Art. 326274</li> <li>• umrüstbar auf <b>Microspline</b> Kassettenkörper Art. 326268</li> <li>• umrüstbar auf Sram XD Drive durch Kassettenfreilaufkörper Art. 326031</li> <li>• Einbaumaß: <b>148 mm</b></li> <li>• PCD: 62/58 mm, FTF: 62,5 mm</li> <li>• A: 35,2 mm, B: 50,3 mm</li> <li>• im Novatec Einzelkarton</li> </ul>	<b>REAR DISC BRAKE HUB ›D462SB‹</b> <ul style="list-style-type: none"> <li>• <b>Boost</b></li> <li>• 32 hole</li> <li>• for <b>12 mm thru axle</b></li> <li>• <b>5 sealed bearings</b></li> <li>• cassette body with <b>5 pawls</b> and ratchet ring with 33 teeth for fast power transmission nearly <b>without delay</b></li> <li>• only 325 g</li> <li>• replacement cassette body art. 326274</li> <li>• conversion kit to <b>Microspline</b> cassette body art. 326268</li> <li>• convertible to Sram XD Drive through cassette body art. 326031</li> <li>• OLD: <b>148 mm</b></li> <li>• PCD: 62/58 mm, FTF: 62.5 mm</li> <li>• A: 35.2 mm, B: 50.3 mm</li> <li>• in Novatec box</li> </ul>	<div style="display: flex; align-items: center;"> </div>
326140 30	<ul style="list-style-type: none"> <li>• mit <b>Microspline</b> Kassettenkörper Art. 326268</li> <li>• Kassettenkörper mit 3 Sperrklinken</li> <li>• im Novatec Einzelkarton</li> </ul>	<ul style="list-style-type: none"> <li>• with <b>Microspline</b> cassette body art. 326268</li> <li>• cassette body with 3 pawls</li> <li>• in Novatec box</li> </ul>	<div style="display: flex; align-items: center;"> </div>
326184 32	<ul style="list-style-type: none"> <li>• <b>verstärkte Nabe</b> um den erhöhten Anforderungen von <b>E-Bikes</b> zu entsprechen</li> <li>• Kassettenkörper mit 3 Sperrklinken</li> <li>• für 8-11 (MTB)-fach Shimano</li> <li>• 463 g</li> <li>• Montageverpackung</li> </ul>	<ul style="list-style-type: none"> <li>• <b>reinforced hub</b> to conform to the increased demands of <b>e-bikes</b></li> <li>• cassette body with 3 pawls</li> <li>• for 8-11 (MTB) speed Shimano</li> <li>• 463 g</li> <li>• OEM</li> </ul>	<div style="display: flex; align-items: center;"> </div>
326435 30	<b>HINTERRADSCHIEBEN-BREMSNABE ›D442SB-S4S-B12-MS‹</b> <ul style="list-style-type: none"> <li>• <b>Boost</b></li> <li>• 32 Loch</li> <li>• für <b>12 mm Steckachse</b></li> <li>• <b>4 Industriekugellager</b></li> <li>• mit <b>Microspline</b> Kassettenkörper</li> <li>• Einbaumaß: <b>148 mm</b></li> <li>• PCD: 58 mm, FTF: 62,9 mm</li> <li>• A: 35,2 mm, B: 49,9 mm</li> <li>• Montageverpackung</li> </ul>	<b>REAR DISC BRAKE HUB ›D442SB-S4S-B12-MS‹</b> <ul style="list-style-type: none"> <li>• <b>Boost</b></li> <li>• 32 hole</li> <li>• for <b>12 mm thru axle</b></li> <li>• <b>4 sealed bearings</b></li> <li>• with <b>microspline</b> cassette body</li> <li>• OLD: <b>148 mm</b></li> <li>• PCD: 58 mm, FTF: 62.9 mm</li> <li>• A: 35.2 mm, B: 49.9 mm</li> <li>• OEM</li> </ul>	<div style="display: flex; align-items: center;"> </div>



# SCHEIBENBREMSNABEN DISC BRAKE HUBS

ART.-NR.	BESCHREIBUNG	DESCRIPTION	
<b>BOOST</b>			
<b>326442</b> 30	<b>VORDERRADSCHIBEN-BREMSNABE ›D041SB-B15‹</b> <ul style="list-style-type: none"> <li>• <b>Boost</b></li> <li>• Aluminium</li> <li>• 32 Loch</li> <li>• für <b>15 mm Steckachse</b></li> <li>• nur 298 g</li> <li>• Einbaumaß: <b>110 mm</b></li> <li>• PCD: 58 mm, FTF: 72 mm</li> <li>• A: 26,2 mm, B: 11,8 mm</li> <li>• neutral, ohne Logo</li> <li>• Montageverpackung</li> </ul>	<b>FRONT DISC BRAKE HUB ›D041SB-B15‹</b> <ul style="list-style-type: none"> <li>• <b>boost</b></li> <li>• aluminium</li> <li>• 32 hole</li> <li>• for <b>15 mm thru axle</b></li> <li>• nur 298 g</li> <li>• OLD: <b>110 mm</b></li> <li>• PCD: 58 mm, FTF: 72 mm</li> <li>• A: 26,2 mm, B: 11.8 mm</li> <li>• neutral, without logo</li> <li>• OEM</li> </ul>	<b>OLD 110</b> 
			UVP 34,90 €
<b>326443</b> 30	<b>HINTERRADSCHIBEN-BREMSNABE ›D952TSE-B12‹</b> <ul style="list-style-type: none"> <li>• <b>Boost</b></li> <li>• Aluminium</li> <li>• 32 Loch</li> <li>• für <b>12 mm Steckachse</b></li> <li>• für 8-11 (MTB)-fach Shimano</li> <li>• nur 394 g</li> <li>• Einbaumaß: <b>148 mm</b></li> <li>• PCD: 58/49 mm, FTF: 64 mm</li> <li>• A: 35 mm, B: 49 mm</li> <li>• neutral, ohne Logo</li> <li>• Montageverpackung</li> </ul>	<b>REAR DISC BRAKE HUB ›D952TSE-B12‹</b> <ul style="list-style-type: none"> <li>• <b>boost</b></li> <li>• aluminium</li> <li>• 32 hole</li> <li>• for <b>12 mm thru axle</b></li> <li>• for 8-11(MTB) speed Shimano</li> <li>• only 394 g</li> <li>• OLD: <b>148 mm</b></li> <li>• PCD: 58/49 mm, FTF: 64 mm</li> <li>• A: 35 mm, B: 49 mm</li> <li>• neutral, without logo</li> <li>• OEM</li> </ul>	<b>OLD 148</b> 
			UVP 49,90 €
<b>DOWNHILL</b>			
<b>326330</b> 30	<b>VORDERRADSCHIBEN-BREMSNABE ›DH61SB-HL‹</b> <ul style="list-style-type: none"> <li>• <b>2 Industriekugellager</b></li> <li>• für <b>20 mm Steckachse</b></li> <li>• 179 g</li> <li>• 32 Loch</li> <li>• Einbaumaß: <b>110 mm</b></li> <li>• PCD: 58/45 mm, FTF: 60,4 mm</li> <li>• A: 30,8 mm, B: 19 mm</li> <li>• im Novatec Einzelkarton</li> </ul>	<b>FRONT DISC BRAKE HUB ›DH61SB-HL‹</b> <ul style="list-style-type: none"> <li>• <b>2 sealed bearings</b></li> <li>• for <b>20 mm thru axle</b></li> <li>• 179 g</li> <li>• 32 hole</li> <li>• OLD: <b>110 mm</b></li> <li>• PCD: 58/45 mm, FTF: 60.4 mm</li> <li>• A: 30.8 mm, B: 19 mm</li> <li>• in Novatec box</li> </ul>	
			UVP 54,90 €
<b>326151</b> 30	<b>HINTERRADSCHIBEN-BREMSNABE ›DH82SB/A-SS‹</b> <ul style="list-style-type: none"> <li>• <b>4 japanische Industriekugellager</b></li> <li>• für <b>12 mm Festachse</b></li> <li>• 390 g</li> <li>• 32 Loch</li> <li>• für 8/9/10/11(MTB)-fach Shimano</li> <li>• Einbaumaß: <b>150 mm</b></li> <li>• PCD: 58/49 mm, FTF: 74,45 mm</li> <li>• A: 31 mm, B: 45 mm</li> <li>• im Novatec Einzelkarton</li> </ul>	<b>REAR DISC BRAKE HUB ›DH82SB/A-SS‹</b> <ul style="list-style-type: none"> <li>• <b>4 Japanese sealed bearings</b></li> <li>• for <b>12 mm solid axle</b></li> <li>• 390 g</li> <li>• 32 hole</li> <li>• for 8/9/10/11(MTB) speed Shimano</li> <li>• OLD: <b>150 mm</b></li> <li>• PCD: 58/49 mm, FTF: 74.45 mm</li> <li>• A: 31 mm, B: 45 mm</li> <li>• in Novatec box</li> </ul>	
			UVP 127,00 €



ART.-NR.	BESCHREIBUNG	DESCRIPTION	
<b>FAT TIRE</b>			
<b>326148</b> 50	<b>VORDERRADSCHNABEN-BREMSNABE ›D101SB‹</b> <ul style="list-style-type: none"> <li>für Fat Tire Bikes</li> <li>36 Loch</li> <li><b>3 in 1:</b> ausgestattet mit 5 mm Aluminium-Schnellspanner, optional umrüstbar für 9 mm und 15 mm</li> <li><b>2 Industriekugellager</b></li> <li>schwarz</li> <li>nur 208 g (ohne Schnellspanner)</li> <li><b>Einbaumaß: 135 mm</b></li> <li>PCD: 58 mm, FTF: 72 mm A: 28 mm, B: 28 mm</li> <li>Montageverpackung</li> </ul>	<b>FRONT DISC BRAKE HUB ›D101SB‹</b> <ul style="list-style-type: none"> <li>for Fat Tire Bikes</li> <li>36 hole</li> <li><b>3 in 1:</b> equipped with aluminium quick release 5 mm, optionally convertible for 9 mm and 15 mm</li> <li><b>2 sealed bearings</b></li> <li>black</li> <li>only 208 g (w/o quick release)</li> <li><b>OLD: 135 mm</b></li> <li>PCD: 58 mm, FTF: 72 mm A: 28 mm, B: 28 mm</li> <li>OEM</li> </ul>	<b>3 IN 1</b>   135 mm
<b>326149</b> 24	<b>HINTERRADSCHNABEN-BREMSNABE ›D102SB/SS‹</b> <ul style="list-style-type: none"> <li>für Fat Tire Bikes</li> <li>36 Loch</li> <li><b>4 in 1:</b> ausgestattet mit 10 mm Aluminium-Schnellspanner, optional umrüstbar für 5 mm, 12 mm und X12</li> <li><b>5 Industriekugellager</b></li> <li>schwarz</li> <li>für 8-11 (MTB)-fach Shimano</li> <li>nur 418 g (ohne Schnellspanner)</li> <li><b>Einbaumaß: 170 mm</b></li> <li>PCD: 58 mm, FTF: 78 mm A: 46 mm, B: 46 mm</li> <li>Montageverpackung</li> </ul>	<b>REAR DISC BRAKE HUB ›D102SB/SS‹</b> <ul style="list-style-type: none"> <li>for Fat Tire Bikes</li> <li>36 hole</li> <li><b>4 in 1:</b> equipped with aluminium quick release 10 mm, optionally convertible for 5 mm, 12 mm and X12</li> <li><b>5 sealed bearings</b></li> <li>black</li> <li>for 8-11 (MTB) speed Shimano</li> <li>only 418 g (w/o quick release)</li> <li><b>OLD: 170 mm</b></li> <li>PCD: 58 mm, FTF: 78 mm A: 46 mm, B: 46 mm</li> <li>OEM</li> </ul>	<b>4 IN 1</b>   170 mm
<b>326132</b> 50	<b>VORDERRADSCHNABEN-BREMSNABE ›D201SB‹</b> <ul style="list-style-type: none"> <li>für Fat Tire Bikes</li> <li>32 Loch</li> <li><b>3 in 1:</b> ausgestattet für <b>15 mm Steckachse</b>, optional umrüstbar für 5 mm und 9 mm</li> <li><b>2 Industriekugellager</b></li> <li>nur 207 g</li> <li><b>Einbaumaß: 150 mm</b></li> <li>PCD: 58 mm, FTF: 90,6 mm A: 26,2 mm, B: 26,2 mm</li> <li>Montageverpackung</li> </ul>	<b>FRONT DISC BRAKE HUB ›D201SB‹</b> <ul style="list-style-type: none"> <li>for Fat Tire Bikes</li> <li>32 hole</li> <li><b>3 in 1:</b> equipped for <b>15 mm thru axle</b>, optionally convertible for 5 mm and 9 mm</li> <li><b>2 sealed bearings</b></li> <li>only 207 g</li> <li><b>OLD: 150 mm</b></li> <li>PCD: 58 mm, FTF: 90.6 mm A: 26.2 mm, B: 26.2 mm</li> <li>OEM</li> </ul>	<b>3 IN 1</b>   150 mm
<b>326134</b> 24	<b>HINTERRADSCHNABEN-BREMSNABE ›D202SB/A4A‹</b> <ul style="list-style-type: none"> <li>für Fat Tire Bikes</li> <li>32 Loch</li> <li><b>4 in 1:</b> ausgestattet für <b>12 x 197 mm Steckachse</b> (für X-12 Schnellspanner), optional umrüstbar für 5 mm (Art. 320292), 10 mm und 12 x 190 mm</li> <li><b>5 Industriekugellager</b></li> <li>für 8-11 (MTB)-fach Shimano</li> <li><b>Einbaumaß: 197 mm</b></li> <li>PCD: 58 mm, FTF: 98 mm A: 49,2 mm, B: 52,5 mm</li> <li>Montageverpackung</li> </ul>	<b>REAR DISC BRAKE HUB ›D202SB/A4A‹</b> <ul style="list-style-type: none"> <li>for Fat Tire Bikes</li> <li>32 hole</li> <li><b>4 in 1:</b> equipped for <b>12 x 197 mm thru axle</b> (for QR X-12), optionally convertible for 5 mm (art. 320292), 10 mm and 12 x 190 mm</li> <li><b>5 sealed bearings</b></li> <li>for 8-11 (MTB) speed Shimano</li> <li><b>OLD: 197 mm</b></li> <li>PCD: 58 mm, FTF: 98 mm A: 49.2 mm, B: 52.5 mm</li> <li>OEM</li> </ul>	<b>4 IN 1</b>   197 mm
<b>320292</b> 50 set	Umrüstset für 5 x 190 mm Schnellspanner	conversion kit for QR 5 x 190 mm	 UVP 32,90 €

ART.-NR.	BESCHREIBUNG	DESCRIPTION	
<b>SEALED</b>			
	<b>VORDERRADSCHIBEN-BREMSNABE ›D041SB‹</b> <ul style="list-style-type: none"> <li>• mit <b>2 Industriekugellagern</b></li> <li>• 216 g (ohne Schnellspanner)</li> <li>• Einbaumaß: 100 mm</li> <li>• PCD: 58 mm, FTF: 62 mm A: 26,2 mm, B: 11,8 mm</li> <li>• Montageverpackung</li> </ul>	<b>FRONT DISC BRAKE HUB ›D041SB‹</b> <ul style="list-style-type: none"> <li>• with <b>2 sealed bearings</b></li> <li>• 216 g (w/o quick release)</li> <li>• OLD: 100 mm</li> <li>• PCD: 58 mm, FTF: 62 mm A: 26.2 mm, B: 11.8 mm</li> <li>• OEM</li> </ul>	
<b>326220</b>	36 Loch	36 hole	UVP 39,90 €
<b>326222</b>	32 Loch	32 hole	
30			
	<b>HINTERRADSCHIBEN-BREMSNABE ›D042SB‹</b> <ul style="list-style-type: none"> <li>• mit <b>4 Industriekugellagern</b></li> <li>• 492 g (ohne Schnellspanner)</li> <li>• für 8-11-fach MTB und 8-10-fach Road Shimano Kasette</li> <li>• Einbaumaß: 135 mm</li> <li>• PCD: 58 mm, FTF: 58,4 mm A: 31,5 mm, B: 45,1 mm</li> <li>• Montageverpackung</li> </ul>	<b>REAR DISC BRAKE HUB ›D042SB‹</b> <ul style="list-style-type: none"> <li>• with <b>4 sealed bearings</b></li> <li>• 492 g (w/o quick release)</li> <li>• for 8-11 speed MTB and 8-10 speed road Shimano cassette</li> <li>• OLD: 135 mm</li> <li>• PCD: 58 mm, FTF: 58.4 mm A: 31.5 mm, B: 45.1 mm</li> <li>• OEM</li> </ul>	
<b>326221</b>	36 Loch	36 hole	UVP 64,90 €
<b>326223</b>	32 Loch	32 hole	
30			
	<b>VORDERRADSCHIBEN-BREMSNABE</b> <ul style="list-style-type: none"> <li>• 32 Loch</li> <li>• mit <b>2 Industriekugellagern</b></li> <li>• <b>CrMo-Achse</b></li> <li>• mit Schnellspanner</li> <li>• Einbaumaß: <b>100 mm</b></li> <li>• PCD: 58 mm, FTF: 58 mm A: 26,5 mm, B: 15,5 mm</li> <li>• Montageverpackung</li> </ul>	<b>FRONT DISC BRAKE HUB</b> <ul style="list-style-type: none"> <li>• 32 holes</li> <li>• with <b>2 sealed bearings</b></li> <li>• <b>CrMo axle</b></li> <li>• with quick release</li> <li>• OLD: <b>100 mm</b></li> <li>• PCD: 58 mm, FTF: 58 mm A: 26.5 mm, B: 15.5 mm</li> <li>• OEM</li> </ul>	
<b>324926</b>	36 Loch	36 hole	UVP 19,90 €
• <b>324920</b>	32 Loch	32 hole	
50			
	<b>HINTERRADSCHIBEN-BREMSNABE</b> <ul style="list-style-type: none"> <li>• 32 Loch</li> <li>• mit <b>2 Industriekugellagern</b></li> <li>• <b>CrMo-Achse</b></li> <li>• mit Schnellspanner</li> <li>• für 8-11-fach MTB und 8-10-fach Road Shimano Kasette</li> <li>• Einbaumaß: <b>135 mm</b></li> <li>• PCD: 58 mm, FTF: 58 mm A: 31 mm, B: 46 mm</li> <li>• Montageverpackung</li> </ul>	<b>REAR DISC BRAKE HUB</b> <ul style="list-style-type: none"> <li>• 32 holes</li> <li>• with <b>2 sealed bearings</b></li> <li>• <b>CrMo axle</b></li> <li>• with quick release</li> <li>• for 8-11 speed MTB and 8-10 speed road Shimano cassette</li> <li>• OLD: <b>135 mm</b></li> <li>• PCD: 58 mm, FTF: 58 mm A: 31 mm, B: 46 mm</li> <li>• OEM</li> </ul>	
<b>324927</b>	36 Loch	36 hole	UVP 33,90 €
• <b>324921</b>	32 Loch	32 hole	
50			

ART.-NR.	BESCHREIBUNG	DESCRIPTION	
<b>GREAT VALUE</b>			<b>GREAT VALUE</b>
<b>326440</b> <small>30</small>	<b>VORDERRAD-SCHEIBENBREMSNABE</b> <ul style="list-style-type: none"> <li>• 36 Loch</li> <li>• mit Aluminium-Schnellspanner</li> <li>• Einbaumaß: 100 mm</li> <li>• PCD: 58 mm, FTF: 62 mm</li> </ul>	<b>FRONT DISC BRAKE HUB</b> <ul style="list-style-type: none"> <li>• 36 hole</li> <li>• with aluminium quick release</li> <li>• OLD: 100 mm</li> <li>• PCD: 58 mm, FTF: 62 mm</li> </ul>	  UVP 14,90 €
<b>325162</b>	<b>HINTERRAD-SCHEIBENBREMSNABE</b> <ul style="list-style-type: none"> <li>• 36 Loch</li> <li>• Einbaumaß: 135 mm</li> </ul>	<b>REAR DISC BRAKE HUB</b> <ul style="list-style-type: none"> <li>• 36 hole</li> <li>• OLD: 135 mm</li> </ul>	  UVP 14,90 €
<b>326441</b> <small>30</small>	<ul style="list-style-type: none"> <li>• für Freilaufzahnkranz,</li> <li>• PCD: 58 mm, FTF: 58 mm</li> </ul>	<ul style="list-style-type: none"> <li>• for freewheel,</li> <li>• PCD: 58 mm, FTF: 58 mm</li> </ul>	  UVP 27,90 €
	<ul style="list-style-type: none"> <li>• für 8-11-fach MTB und 8-10-fach Road Shimano Kassette,</li> <li>• PCD: 58 mm, FTF: 52 mm A: 31,5 mm, B: 46,4 mm</li> </ul>	<ul style="list-style-type: none"> <li>• for 8-11 speed MTB and 8-10 speed road Shimano cassette,</li> <li>• PCD: 58 mm, FTF: 52 mm A: 31.5 mm, B: 46.4 mm</li> </ul>	



ART.-NR. 	BESCHREIBUNG	DESCRIPTION	
			
<p><b>ULTRALIGHT</b></p> <p><b>326374</b> <b>VORDERRADNABE ›AS61CB/A‹</b> 30</p> <ul style="list-style-type: none"> <li>• UD-Carbon Straight Pull-Nabe</li> <li>• <b>2 japanische Industriekugellager</b></li> <li>• 20 Loch</li> <li>• nur <b>69 g</b> (ohne Schnellspanner)</li> <li>• Einbaumaß: 100 mm</li> <li>• im Novatec Einzelkarton</li> </ul>	<p><b>CARBON</b></p> <p><b>FRONT HUB ›AS61CB/A‹</b></p> <ul style="list-style-type: none"> <li>• UD carbon straight pull hub</li> <li>• <b>2 Japanese sealed bearings</b></li> <li>• 20 hole</li> <li>• only <b>69 g</b> (w/o quick release)</li> <li>• OLD: 100 mm</li> <li>• in Novatec box</li> </ul> <p style="text-align: right;">UVP 97,90 €</p>		<p><b>ULTRALIGHT</b></p> <div style="text-align: right;">  69 g   </div> <div style="text-align: center;"> <p><b>CARBON</b></p>  </div>
<p><b>326375</b> <b>HINTERRADNABE ›FS62CB/A-AA-11S‹</b> 30</p> <ul style="list-style-type: none"> <li>• UD-Carbon Straight Pull-Nabe</li> <li>• für Shimano 8-11-fach (MTB + Road)</li> <li>• <b>1 japanisches und 3 Industriekugellager</b></li> <li>• 24 Loch</li> <li>• nur <b>215 g</b> (ohne Schnellspanner)</li> <li>• Einbaumaß: 130 mm</li> <li>• umrüstbar für Campagnolo-Zahnkranz mit Kassettenfreilaufkörper Art. 325706</li> <li>• im Novatec Einzelkarton</li> </ul>	<p><b>REAR HUB ›FS62CB/A-AA-11S‹</b></p> <ul style="list-style-type: none"> <li>• UD carbon straight pull hub</li> <li>• for Shimano 8-11 speed (MTB + Road)</li> <li>• <b>1 Japanese and 3 sealed bearings</b></li> <li>• 24 hole</li> <li>• only <b>215 g</b> (w/o quick release)</li> <li>• OLD: 130 mm</li> <li>• convertible for Campagnolo sprocket with cassette body art. 325706</li> <li>• in Novatec box</li> </ul> <p style="text-align: right;">UVP 149,00 €</p>		<p><b>LIGHTEST ROAD REAR</b></p> <div style="text-align: right;">  215 g   </div> <div style="text-align: center;"> <p><b>CARBON</b></p>  </div> <div style="text-align: right;">  </div>
<p><b>325175</b> <b>VORDERRADNABE ›A291SB/A-SL‹</b> 30</p> <ul style="list-style-type: none"> <li>• 20 Loch</li> <li>• <b>2 japanische Industriekugellager</b></li> <li>• nur <b>59 g</b> (ohne Schnellspanner)</li> <li>• mit <b>abnehmbarem</b> Schnellspannhebel</li> <li>• Speichenlöcher auch passend für Aero-Speichen (bis 2,5 mm)</li> <li>• Einbaumaß: 100 mm</li> <li>• PCD: 30 mm, FTF: 68,7 mm A: 16 mm, B: 16 mm</li> <li>• im Novatec Einzelkarton</li> </ul>	<p><b>FRONT HUB ›A291SB/A-SL‹</b></p> <ul style="list-style-type: none"> <li>• 20 hole</li> <li>• <b>2 Japanese sealed bearings</b></li> <li>• only <b>59 g</b> (w/o quick release)</li> <li>• with <b>removable</b> quick release lever</li> <li>• holes also suitable for Aero spokes (up to 2.5 mm)</li> <li>• OLD: 100 mm</li> <li>• PCD: 30 mm, FTF: 68.7 mm A: 16 mm, B: 16 mm</li> <li>• in Novatec box</li> </ul> <p style="text-align: right;">UVP 66,90 €</p>		<p><b>LIGHTEST ROAD FRONT</b></p> <div style="text-align: right;">  59 g   </div> <div style="text-align: center;">  </div> <div style="text-align: right;">  </div>











ART.-NR.	BESCHREIBUNG	DESCRIPTION	
<b>SUPERLIGHT</b>			
	<b>VORDERRADNABE ›A291SB‹</b> <ul style="list-style-type: none"> <li>mit <b>2 Industriekugellagern</b></li> <li>mit <b>abnehmbarem</b> Schnellspannhebel</li> <li>Speichenlöcher auch passend für Aero-Speichen (bis 2,5 mm)</li> <li>Einbaumaß: 100 mm</li> <li>PCD: 30 mm, FTF: 68,7 mm A: 15,6 mm, B: 15,6 mm</li> <li>im Novatec Einzelkarton</li> </ul>	<b>FRONT HUB ›A291SB‹</b> <ul style="list-style-type: none"> <li>with <b>2 sealed bearings</b></li> <li>with <b>removable</b> quick release lever</li> <li>holes also suitable for Aero spokes (up to 2.5 mm)</li> <li>OLD: 100 mm</li> <li>PCD: 30 mm, FTF: 68.7 mm A: 15.6 mm, B: 15.6 mm</li> <li>in Novatec box</li> </ul>	  
<b>325268</b>	32 Loch, <b>76 g</b> (ohne Schnellspanner)	32 hole, <b>76 g</b> (w/o quick release)	
30			
<b>325353</b>	28 Loch, Montageverpackung	28 hole, OEM	
50			
<b>325210</b>	20 Loch	20 hole	
30			UVP 42,90 €
<b>SUPERLIGHT</b>			
	<b>HINTERRADNABE ›F482SB/A4A-11S‹</b> <ul style="list-style-type: none"> <li>mit <b>4 Industriekugellagern</b></li> <li>Aluminium-Kassettenfreilaufkörper</li> <li>für <b>8-11-fach</b> Shimano Kasette (MTB + Road)</li> <li>umrüstbar für Campagnolo-Zahnkranz mit Kassettenfreilaufkörper Art. 325706</li> <li><b>235 g</b> (ohne Schnellspanner)</li> <li>Speichenlöcher auch passend für Aero-Speichen (bis 2,5 mm)</li> <li>Einbaumaß: 130 mm</li> <li>PCD: 41/49 mm, FTF: 57 mm A: 27,2 mm, B: 47,4 mm</li> <li>im Novatec Einzelkarton</li> </ul>	<b>REAR HUB ›F482SB/A4A-11S‹</b> <ul style="list-style-type: none"> <li>with <b>4 sealed bearings</b></li> <li>aluminium cassette body</li> <li>for <b>8-11</b> speed Shimano cassette (MTB + road)</li> <li>convertible for Campagnolo sprocket with cassette body art. 325706</li> <li><b>235 g</b> (w/o quick release)</li> <li>holes also suitable for Aero spokes (up to 2.5 mm)</li> <li>OLD: 130 mm</li> <li>PCD: 41/49 mm, FTF: 57 mm A: 27.2 mm, B: 47.4 mm</li> <li>in Novatec box</li> </ul>	   
<b>326080</b>	32 Loch	32 hole	
<b>326081</b>	24 Loch	24 hole	
30			UVP 89,90 €
<b>LIGHT + SEALED + NICE PRICE</b>			
	<b>VORDERRADNABE ›A141SB‹</b> <ul style="list-style-type: none"> <li>mit <b>2 austauschbaren Industriekugellagern</b></li> <li><b>118 g</b> (ohne Schnellspanner)</li> <li>Einbaumaß: 100 mm</li> <li>PCD: 38 mm, FTF: 72 mm A: 14 mm, B: 14 mm</li> <li>Montageverpackung</li> </ul>	<b>FRONT HUB ›A141SB‹</b> <ul style="list-style-type: none"> <li>with <b>2 replaceable sealed bearings</b></li> <li><b>118 g</b> (w/o quick release)</li> <li>OLD: 100 mm</li> <li>PCD: 38 mm, FTF: 72 mm A: 14 mm, B: 14 mm</li> <li>OEM</li> </ul>	  
<b>325156</b>	36 Loch	36 hole	
<b>325157</b>	32 Loch	32 hole	
50			UVP 21,90 €
	<b>HINTERRADNABE ›F162SB/AA-11S‹</b> <ul style="list-style-type: none"> <li>mit <b>4 Industriekugellagern</b></li> <li><b>276 g</b> (ohne Schnellspanner)</li> <li>für 8-11-fach Road + MTB Shimano Kasette mit <b>3 Sperrklinken</b> (Ersatzkassettenfreilaufkörper Art. 326292)</li> <li>umrüstbar auf Campagnolo Art. 325283</li> <li>Einbaumaß: 135 mm</li> <li>PCD: 49 mm, FTF: 57,3 mm A: 31,25, B: 46,45</li> <li>Montageverpackung</li> </ul>	<b>REAR HUB ›F162SB/AA-11S‹</b> <ul style="list-style-type: none"> <li>with <b>4 sealed bearings</b></li> <li><b>276 g</b> (w/o quick release)</li> <li>for 8-11 speed road + MTB Shimano cassette with <b>3 pawls</b> (replacement cassette body art. 326292)</li> <li>convertible to Campagnolo art. 325283</li> <li>OLD: 135 mm</li> <li>PCD: 49 mm, FTF: 57.3 mm A: 31.25, B: 46.45</li> <li>OEM</li> </ul>	  
<b>325158</b>	36 Loch	36 hole	
<b>325159</b>	32 Loch	32 hole	
50			UVP 59,90 €

# NON-DISC NABEN NON-DISC HUBS





ART.-NR.	BESCHREIBUNG	DESCRIPTION	
<b>GREAT VALUE</b>			<b>GREAT VALUE</b>
	<b>VORDERRADNABE</b> <ul style="list-style-type: none"> <li>• Aluminium</li> <li>• mit <b>Aluminium-Schnellspanner</b></li> <li>• Einbaumaß: 100 mm</li> <li>• PCD: 38 mm, FTF: 72 mm A: 14 mm, B: 14 mm</li> <li>• Montageverpackung</li> </ul>	<b>FRONT HUB</b> <ul style="list-style-type: none"> <li>• aluminium</li> <li>• with <b>aluminium quick release</b></li> <li>• OLD: 100 mm</li> <li>• PCD: 38 mm, FTF: 72 mm A: 14 mm, B: 14 mm</li> <li>• OEM</li> </ul>	
	36 Loch	36 hole	
<b>325031</b>	silber, abgedichtet	silver, sealed	UVP 8,90 €
• <b>325134</b>	silber, Modell ›Eco‹	silver, model ›Eco‹	UVP 6,90 €
	32 Loch	32 hole	
• <b>324917</b>	schwarz, Modell ›Eco‹ 100	black, model ›Eco‹	UVP 6,90 €
	<b>HINTERRADNABE</b>	<b>REAR HUB</b>	
	<ul style="list-style-type: none"> <li>• Aluminium</li> <li>• mit <b>Aluminium-Schnellspanner</b></li> <li>• Einbaumaß: 130 mm</li> <li>• PCD: 45 mm, FTF: 57 mm A: 30 mm, B: 43 mm</li> <li>• Montageverpackung</li> </ul>	<ul style="list-style-type: none"> <li>• aluminium</li> <li>• with <b>aluminium quick release</b></li> <li>• OLD: 130 mm</li> <li>• PCD: 45 mm, FTF: 57 mm A: 30 mm, B: 43 mm</li> <li>• OEM</li> </ul>	
	36 Loch	36 hole	
<b>325036</b>	silber, abgedichtet	silver, sealed	UVP 9,90 €
• <b>325135</b>	silber, Modell ›Eco‹	silver, model ›Eco‹	UVP 7,90 €
	32 Loch	32 hole	
• <b>324939</b>	schwarz, Modell ›Eco‹ 50	black, model ›Eco‹	UVP 6,90 €
	<b>HINTERRADNABE</b>	<b>REAR HUB</b>	
	<ul style="list-style-type: none"> <li>• <b>gute Staub- und Wasserabdichtung</b></li> <li>• 36 Loch</li> <li>• Einbaumaß: 135 mm</li> <li>• PCD: 45 mm, FTF: 57 mm A: 32,8 mm, B: 46 mm</li> <li>• Montageverpackung</li> </ul>	<ul style="list-style-type: none"> <li>• <b>good dust- and waterprotection</b></li> <li>• 36 hole</li> <li>• OLD: 135 mm</li> <li>• PCD: 45 mm, FTF: 57 mm A: 32.8 mm, B: 46 mm</li> <li>• OEM</li> </ul>	
	36 Loch	36 hole	
<b>324858</b>	für 7-fach Kassette	for 7 speed cassette	UVP 23,90 €
<b>324854</b>	für 8-11-fach MTB und 8-10-fach Road Kassette 50	for 8-11 speed and 8-10 speed road cassette	UVP 23,90 €

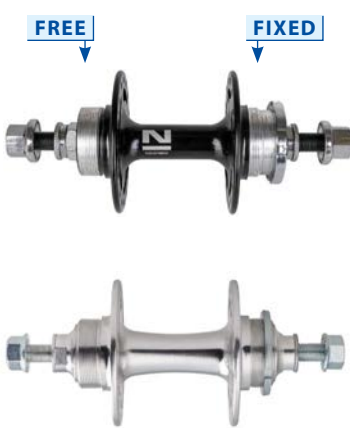



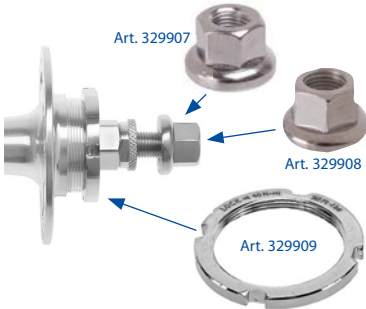





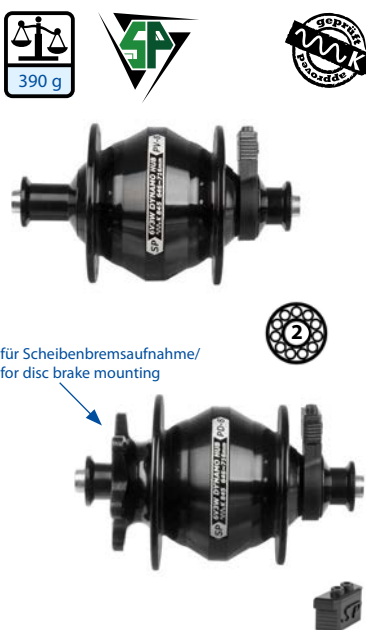

ART.-NR.	BESCHREIBUNG	DESCRIPTION	
<b>GREAT VALUE</b>		<b>GREAT VALUE</b>	
	<b>VORDERRADNABE</b> <ul style="list-style-type: none"> <li>• Aluminium</li> <li>• Vollachse, mit Achsmuttern (Art. 329902)</li> <li>• 36 Loch</li> <li>• Einbaumaß: 100 mm</li> <li>• PCD: 38 mm, FTF: 72 mm A: 14 mm, B: 14 mm</li> <li>• Montageverpackung</li> </ul>	<b>FRONT HUB</b> <ul style="list-style-type: none"> <li>• aluminium</li> <li>• solid type, with nuts (art. 329902)</li> <li>• 36 hole</li> <li>• OLD: 100 mm</li> <li>• PCD: 38 mm, FTF: 72 mm A: 14 mm, B: 14 mm</li> <li>• OEM</li> </ul>	
• 325064	schwarz	black	
• 325021	silber	silver	UVP 6,90 €
	›ECO‹	›ECO‹	
• 324928	schwarz	black	
• 325130	silber	silver	UVP 4,90 €
100			
	<b>HINTERRADNABE</b> <ul style="list-style-type: none"> <li>• Aluminium</li> <li>• Vollachse, mit Achsmuttern (Art. 329902)</li> <li>• 36 Loch</li> <li>• Einbaumaß: 130 mm</li> <li>• PCD: 45 mm, FTF: 57 mm A: 31,5 mm, B: 41,5 mm</li> <li>• Montageverpackung</li> </ul>	<b>REAR HUB</b> <ul style="list-style-type: none"> <li>• aluminium</li> <li>• solid type, with nuts (art. 329902)</li> <li>• 36 hole</li> <li>• OLD: 130 mm</li> <li>• PCD: 45 mm, FTF: 57 mm A: 31.5 mm, B: 41.5 mm</li> <li>• OEM</li> </ul>	
• 325065	schwarz	black	
• 325026	silber	silver	UVP 6,90 €
	›ECO‹	›ECO‹	
• 324929	schwarz	black	
• 325132	silber	silver	UVP 5,90 €
50			
• 325001	<b>VORDERRADNABE</b> <ul style="list-style-type: none"> <li>• Stahl</li> <li>• 36 Loch</li> <li>• Vollachse</li> <li>• mit Achsmuttern</li> <li>• Einbaumaß: 100 mm</li> <li>• PCD: 38 mm, FTF: 62 mm A: 19 mm, B: 19 mm</li> <li>• Montageverpackung</li> </ul>	<b>FRONT HUB</b> <ul style="list-style-type: none"> <li>• steel</li> <li>• 36 hole</li> <li>• solid type</li> <li>• with nuts</li> <li>• OLD: 100 mm</li> <li>• PCD: 38 mm, FTF: 62 mm A: 19 mm, B: 19 mm</li> <li>• OEM</li> </ul>	
100			UVP 3,90 €
• 325006	<b>HINTERRADNABE</b> <ul style="list-style-type: none"> <li>• Stahl</li> <li>• 36 Loch</li> <li>• Vollachse</li> <li>• mit Achsmuttern</li> <li>• Einbaumaß: 130 mm</li> <li>• PCD: 44 mm, FTF: 57 mm A: 30 mm, B: 43 mm</li> <li>• Montageverpackung</li> </ul>	<b>REAR HUB</b> <ul style="list-style-type: none"> <li>• steel</li> <li>• 36 hole</li> <li>• solid type</li> <li>• with nuts</li> <li>• OLD: 130 mm</li> <li>• PCD: 44 mm, FTF: 57 mm A: 30 mm, B: 43 mm</li> <li>• OEM</li> </ul>	
50			UVP 4,90 €

ART.-NR.	BESCHREIBUNG	DESCRIPTION	
  <b>326700</b>  <b>326701</b> 30  <b>325932</b> 50	<b>VORDERRADNABE ›A565SBT‹</b>  <ul style="list-style-type: none"> <li>für Vorderrad Hochflansch</li> <li>mit 2 <b>Industriekugellagern</b></li> <li><b>CrMo</b>-Achse M9 x 140 mm</li> <li>Einbaumaß: 100 mm</li> <li>PCD: 62 mm, FTF: 70 mm</li> <li>A: 15 mm, B: 15 mm</li> <li>Montageverpackung</li> </ul> <ul style="list-style-type: none"> <li><b>36 Loch</b></li> <li>silber</li> </ul> <ul style="list-style-type: none"> <li><b>32 Loch</b></li> <li>schwarz eloxiert</li> </ul> Modell ›Eco‹ <ul style="list-style-type: none"> <li>32 Loch</li> <li><b>Aluminium</b>-Dichtungsscheiben</li> <li>silber</li> <li>PCD: 63 mm, FTF: 70 mm</li> </ul>	<b>FRONT HUB ›A565SBT‹</b>  <ul style="list-style-type: none"> <li>front high flange</li> <li>with 2 <b>sealed bearings</b></li> <li><b>CrMo</b> axle M9 x 140 mm</li> <li>OLD: 100 mm</li> <li>PCD: 62 mm, FTF: 70 mm</li> <li>A: 15 mm, B: 15 mm</li> <li>OEM</li> </ul> <ul style="list-style-type: none"> <li><b>36 hole</b></li> <li>silver</li> </ul> <ul style="list-style-type: none"> <li><b>32 hole</b></li> <li>black anodised</li> </ul> model ›Eco‹ <ul style="list-style-type: none"> <li>32 hole</li> <li>sealed <b>aluminium</b> washers</li> <li>silver</li> <li>PCD: 63 mm, FTF: 70 mm</li> </ul> UVP 38,90 €  UVP 39,90 €  UVP 17,90 €	 
<b>326702</b>  <b>326703</b> 30	<b>HINTERRADNABE ›A566SBT‹</b>  <ul style="list-style-type: none"> <li>für Hinterrad Hochflansch</li> <li>32 Loch</li> <li>mit 2 <b>Industriekugellagern</b></li> <li><b>CrMo</b>-Achse M10 x 165 mm</li> <li>Einbaumaß: 120 mm</li> <li>PCD: 62 mm, FTF: 59 mm</li> <li>A: 30,5 mm, B: 30,5 mm</li> <li>Montageverpackung</li> </ul> Gewinde 1,37" und 1,29" <b>beidseitig</b>	<b>REAR HUB ›A566SBT‹</b>  <ul style="list-style-type: none"> <li>rear high flange</li> <li>32 hole</li> <li>with 2 <b>sealed bearings</b></li> <li><b>CrMo</b> axle M10 x 165 mm</li> <li>OLD: 120 mm</li> <li>PCD: 62 mm, FTF: 59 mm</li> <li>A: 30,5 mm, B: 30,5 mm</li> <li>OEM</li> </ul> thread 1.37" and 1.29" on <b>both sides</b>  <ul style="list-style-type: none"> <li>36 hole</li> <li>silver</li> </ul> <ul style="list-style-type: none"> <li>32 hole</li> <li>black anodised</li> </ul> UVP 51,90 €	 
<b>326704</b> 30  <b>325933</b> 50	<ul style="list-style-type: none"> <li><b>free/ fixed</b></li> <li>Gewinde 1,37" und 1,37/1,29"</li> <li>schwarz eloxiert</li> </ul> Modell ›Eco‹ <ul style="list-style-type: none"> <li><b>Aluminium</b>-Dichtungsscheiben</li> <li>silber</li> <li>PCD: 62 mm, FTF: 60 mm</li> </ul>	<ul style="list-style-type: none"> <li><b>free/ fixed</b></li> <li>thread 1.37" and 1.37/1.29"</li> <li>black anodised</li> </ul> model ›Eco‹ <ul style="list-style-type: none"> <li>sealed <b>aluminium</b> washers</li> <li>silver</li> <li>PCD: 62 mm, FTF: 60 mm</li> </ul> UVP 44,90 €  UVP 24,90 €	







ART.-NR.	BESCHREIBUNG	DESCRIPTION	
			
<b>329907</b>	<b>BAHN/SINGLE SPEED-NABENZUBEHÖR</b> Mutter für <b>VR</b> -Bahn-Naben (Art. 326700, ...)	<b>TRACK/SINGLE SPEED HUB ACCESSORIES</b> nut for <b>front</b> track hubs (art. 326700, ...)	
<b>329908</b> 100	Mutter für <b>Hinterrad</b> -Bahn-Naben (Art. 326702, ...)	nut for <b>rear</b> track hubs (art. 326702, ...)	
<b>329909</b> 300	Zahnkranzverschlussring für Hinterrad-Naben (Art. 326702, ...)	lock ring for rear hubs (art. 326702, ...)	
<b>700136</b> AD	<b>FREILAUFZAHNKRANZ 1/2 X 1/8"</b> • BSA-Gewinde • <b>Full Ball</b> • silber 16 Zähne	<b>FREEWHEEL 1/2 X 1/8"</b> • BSA thread • <b>full ball</b> • silver 16 teeth	
<b>700138</b> AD 100	18 Zähne	18 teeth UVP 4,90 € UVP mAD 7,90 €	
<b>325797</b>	<b>ZAHNKRANZ 1/2 X 1/8"</b> 13 Zähne	<b>SPROCKET 1/2 X 1/8"</b> 13 teeth	
<b>325591</b>	14 Zähne	14 teeth	
<b>325592</b>	15 Zähne	15 teeth	
<b>325593</b>	16 Zähne	16 teeth	
<b>325604</b> <b>325594</b> 200/50	17 Zähne 18 Zähne	17 teeth 18 teeth UVP 4,90 €	
<b>320070</b>	<b>SINGLE-SPEED-UMRÜSTKIT</b> zur Umrüstung von Shimano 8/9/10-fach Kassettennabe auf Single Speed • 3 x Zahnkränze 14, 16 und 18 Zähne • 2 x flexibel anbringbare Distanzringe (13,25 und 20,25 mm Breite) zur Optimierung der Kettenlinie durch 4 verschiedene Positionen auf M-Wave Eurolochkarte	<b>SINGLE SPEED REFIT SET</b> for conversion from Shimano 8/9/10 speed cassette hub to single speed • 3 x sprockets 14, 16 and 18 teeth • 2 x flexibly attachable spacers (13.25 and 20.25 mm width) for optimizing the chain line through 4 different positions on M-Wave eurohole card	
<b>320071</b> 50 set	Montageverpackung	OEM UVP 14,90 €	
<b>329984</b> 25 pair	<b>ACHSVERLÄNGERUNG</b> Fußraster für BMX-Räder • <b>Aluminium</b> • silber eloxiert • für <b>14 mm</b> -Achsen • 50 x 110 mm • Montageverpackung	<b>AXLE PEGS</b> foot peg for BMX bikes • <b>aluminium</b> • silver anodized • for <b>14 mm</b> axles • 50 x 110 mm • OEM	
<b>329982</b>	für <b>14 mm</b> -Achsen, verchromt	for <b>14 mm</b> axles, c.p.	
<b>329985</b> 20 pair	für <b>3/8"</b> x <b>26 TPI</b> -Achsen, schwarz	for <b>3/8"</b> x <b>26 TPI</b> axles, black UVP 6,90 €	

ART.-NR. 	BESCHREIBUNG	DESCRIPTION	
	<p><b>NABENDYNAMO ›SHUTTER‹</b></p> <ul style="list-style-type: none"> <li>• Aluminium</li> <li>• schwarz eloxiert</li> <li>• <b>klein und leicht, nur 390 g</b></li> <li>• sehr <b>leicht laufend</b></li> <li>• <b>Wirkungsgrad 72 %</b> bei 15 km/h</li> <li>• mit <b>2 Industriekugellagern</b></li> <li>• Einbaumaß: 100 mm</li> <li>• 32 Loch (andere Lochzahl auf Anfrage)</li> <li>• 6 V/3 W</li> <li>• mit Hohlachse für <b>Schnellspanner</b></li> <li>• mit <b>deutschem Prüfzeichen</b></li> <li>• geeignet für 26" - 28"</li> <li>• mit <b>Flachstecker</b> für Dynamokabel</li> <li>• Montageverpackung</li> </ul>	<p><b>HUB DYNAMO ›SHUTTER‹</b></p> <ul style="list-style-type: none"> <li>• aluminium</li> <li>• black anodized</li> <li>• <b>small and light, only 390 g</b></li> <li>• very <b>smooth running</b></li> <li>• <b>efficiency 72 %</b> at 15 km/h</li> <li>• with <b>2 sealed bearings</b></li> <li>• OLD: 100 mm</li> <li>• 32 hole (other number of holes on request)</li> <li>• 6 V/3 W</li> <li>• with hollow axle for <b>QR</b></li> <li>• with <b>German approval number</b></li> <li>• suitable for 26" - 28"</li> <li>• with <b>flat plug</b> for dynamo cable</li> <li>• OEM</li> </ul>	 <p>für Scheibenbremsaufnahme/ for disc brake mounting</p>
<p><b>460020</b> 25</p>	<p>für <b>V-Bremse</b></p>	<p>for <b>V-brake</b> UVP 129,00 €</p>	
<p><b>460025</b> 36</p>	<p>für <b>Scheibenbremse</b></p>	<p>for <b>disc brake</b> UVP 156,00 €</p>	
	<p><b>Auch für Steckachse erhältlich!</b></p>	<p><b>Also available for thru axle!</b></p>	
	<p><b>NABENDYNAMO</b></p> <ul style="list-style-type: none"> <li>• Aluminium</li> <li>• Einbaumaß: 100 mm</li> <li>• 6 V/3 W</li> <li>• für 16" - 28"</li> <li>• Montageverpackung</li> </ul> <p><b>588343 ›SHIMANO DH-3D32-QR‹</b> 20</p> <ul style="list-style-type: none"> <li>• für <b>Scheibenbremse</b></li> <li>• mit <b>deutschem Prüfzeichen</b></li> <li>• 32 Loch</li> <li>• mit Schnellspanner</li> <li>• mit Stecker und Verbinder</li> </ul>	<p><b>HUB DYNAMO</b></p> <ul style="list-style-type: none"> <li>• aluminium</li> <li>• OLD: 100 mm</li> <li>• 6 V/3 W</li> <li>• for 16" - 28"</li> <li>• OEM</li> </ul> <p><b>›SHIMANO DH-3D32-QR‹</b></p> <ul style="list-style-type: none"> <li>• for <b>disc brake</b></li> <li>• with <b>German approval number</b></li> <li>• 32 hole</li> <li>• with QR</li> <li>• with plug and connector</li> </ul> <p>UVP 95,90 €</p>	 <p>für Scheibenbremsaufnahme/ for disc brake mounting</p>
	<p><b>›SHIMANO DH-C3000-3N-NT‹</b></p> <ul style="list-style-type: none"> <li>• mit <b>deutschem Prüfzeichen</b></li> <li>• mit Festachse</li> </ul> <p><b>587791</b></p> <ul style="list-style-type: none"> <li>• 36 Loch</li> <li>• silber</li> </ul> <p><b>588347</b> 20</p> <ul style="list-style-type: none"> <li>• 32 Loch</li> <li>• schwarz</li> </ul>	<p><b>›SHIMANO DH-C3000-3N-NT‹</b></p> <ul style="list-style-type: none"> <li>• with <b>German approval number</b></li> <li>• with solid axle</li> </ul> <ul style="list-style-type: none"> <li>• 36 hole</li> <li>• silver</li> <li>• 32 hole</li> <li>• black</li> </ul> <p>UVP 58,90 €</p>	
<p>• <b>460036</b> 500/100</p>	<p><b>Stecker</b> für Nabendynamos, (kein original Shimano Ersatzteil), ...</p>	<p><b>connector</b> for hub dynamos, (no original Shimano spare part), ...</p> <p>UVP 0,99 €</p>	

ART.-NR.	BESCHREIBUNG	DESCRIPTION	
<ul style="list-style-type: none"> <li>• <b>460063</b> <b>NEW</b></li> <li>• <b>460055</b></li> <li>• <b>460056</b> 12</li> </ul>	<p><b>NABENDYNAMO</b></p> <ul style="list-style-type: none"> <li>• <b>Aluminium</b></li> <li>• Einbaumaß: 100 mm</li> <li>• 36 Loch</li> <li>• 6 V/3 W</li> <li>• mit <b>deutschem Prüfzeichen</b></li> <li>• mit Verbindungsstecker (Art. 460036), passend auch für Shimano (kein original Shimano Ersatzteil)</li> <li>• geeignet für 16" - 28"</li> </ul> <p>mit Festachse</p> <p>schwarz</p> <p>silber</p> <p>mit Schnellspanner</p>	<p><b>HUB DYNAMO</b></p> <ul style="list-style-type: none"> <li>• <b>aluminium</b></li> <li>• OLD: 100 mm</li> <li>• 36 hole</li> <li>• 6 V/3 W</li> <li>• with <b>German approval number</b></li> <li>• with connector (art. 460036), also suitable for Shimano (no original Shimano spare part)</li> <li>• suitable for 16" - 28"</li> </ul> <p>with solid axle</p> <p>black</p> <p>silver</p> <p>with quick release</p>	
<ul style="list-style-type: none"> <li>• <b>460057</b> 12</li> </ul>	<p>für <b>Scheibenbremse</b>, mit Festachse</p>	<p>for <b>disc brake</b>, with solid axle</p>	
<p><b>587117</b> 20</p> <p><b>587118</b> 200 set</p>	<p><b>NEXUS 3-GANG RÜCKTRITTBREMSNABE</b></p> <p>Nabe SG-3C41</p> <ul style="list-style-type: none"> <li>• 36 Loch</li> <li>• Einbaumaß: 120 mm</li> <li>• Achslänge: 168 mm</li> </ul> <p>Montagesatz für Nabe SG-3C41 Art. 587117</p> <ul style="list-style-type: none"> <li>• 2 Achsmuttern</li> <li>• 1 Fixierscheibe</li> <li>• 1 Sprengring</li> <li>• 1 Staubkappe</li> <li>• 1 Schubstange</li> </ul> <p>(Schutzbügel, Zahnkranz und Bandage müssen dazu bestellt werden.)</p>	<p><b>NEXUS 3-SPEED COASTER BRAKE HUB</b></p> <p>hub SG-3C41</p> <ul style="list-style-type: none"> <li>• 36 hole</li> <li>• OLD: 120 mm</li> <li>• axle length: 168 mm</li> </ul> <p>mounting components for hub SG-3C41 art. 587117</p> <ul style="list-style-type: none"> <li>• 2 axle nuts</li> <li>• 1 non-turn washer</li> <li>• 1 snap ring</li> <li>• 1 dust cap</li> <li>• 1 push rod</li> </ul> <p>(Derailleur guard, sprocket and clamp must be ordered separately.)</p>	
<p><b>587116</b> 60 set</p>	<p>Drehgriff-Schalthebel Revo SL-3S41E</p> <ul style="list-style-type: none"> <li>• Innenzug 2.200 mm</li> <li>• Außenhülle SP-40, 2.000 mm</li> <li>• mit Clickbox</li> </ul>	<p>twist shifter Revo SL-3S41E</p> <ul style="list-style-type: none"> <li>• inner casing 2,200 mm</li> <li>• outer casing SP-40, 2,000 mm</li> <li>• with click box</li> </ul>	
<p><b>325408</b> <b>NEW</b> 100</p>	<p>Drehgriffschalter DN85-8</p> <ul style="list-style-type: none"> <li>• 8 Gang</li> <li>• Edelstahl-Innenzug 2.140 mm</li> <li>• rechts</li> <li>• Montageverpackung</li> </ul>	<p>twist lever DN85-8</p> <ul style="list-style-type: none"> <li>• 8 speed</li> <li>• stainless steel inner cable 2,140 mm</li> <li>• right</li> <li>• OEM</li> </ul>	
<p><b>325407</b> <b>NEW</b> 100</p>	<p>Drehgriffschalter DN85-7</p> <ul style="list-style-type: none"> <li>• 7 Gang</li> <li>• Edelstahl-Innenzug 2.140 mm</li> <li>• rechts</li> <li>• Montageverpackung</li> </ul>	<p>twist lever DN85-7</p> <ul style="list-style-type: none"> <li>• 7 speed</li> <li>• stainless steel inner cable 2,140 mm</li> <li>• right</li> <li>• OEM</li> </ul>	
<p><b>325449</b> <b>NICE PRICE</b> 50</p>	<p>3-fach Drehgriffschalter</p> <ul style="list-style-type: none"> <li>• <b>Nirosta</b>-Innenzug 2.000 mm</li> <li>• Montageverpackung</li> </ul>	<p>3 speed twist lever</p> <ul style="list-style-type: none"> <li>• <b>stainless steel</b> inner cable 2,000 mm</li> <li>• OEM</li> </ul>	

# RÜCKTRITTBREMSNABEN COASTER BRAKE HUBS

ART.-NR.	BESCHREIBUNG	DESCRIPTION	
 • <b>325467</b> 25	<b>RÜCKTRITTBREMSNABE</b> <ul style="list-style-type: none"> <li>• 36 Loch</li> <li>• verchromt</li> <li>• mit Achsmuttern</li> <li>• Einbaumaß: 110 mm</li> <li>• Achslänge: 165 mm (andere Achslängen und Lochzahlen sind ebenfalls lieferbar)</li> </ul>	<b>COASTER BRAKE HUB</b> <ul style="list-style-type: none"> <li>• 36 hole</li> <li>• chromium plated</li> <li>• with axle nuts</li> <li>• OLD: 110 mm</li> <li>• axle length: 165 mm (other axle lengths and holes are also available)</li> </ul>	 <small>according to EN 14764</small>  UVP 12,90 €
• <b>325484</b> AD • <b>325485</b> AD • <b>325486</b> AD • <b>325487</b> AD 200/50	<b>ZAHNKRANZ</b> für 1/2" x 3/32" (und 1/2" x 1/8") Kette  16 Zähne  18 Zähne  19 Zähne  20 Zähne	<b>SPROCKET</b> for 1/2" x 3/32" (and 1/2" x 1/8") chain  16 teeth  18 teeth  19 teeth  20 teeth	  UVP 1,99 € UVP mAD 2,99 €
• <b>325482</b> 1.000	<b>Universal-Bandage</b> mit Schraube und Mutter, verzinkt, passend für fast alle Rücktrittbremsnaben und Kettenstreben	<b>universal clamp</b> with screw and nut, c.p., suitable for almost all coaster brake hubs and chain stays	  UVP 0,79 €



# microSHIFT

ab Seite 663 // from page 663



ART.-NR.	BESCHREIBUNG	DESCRIPTION	
	<b>KASSETTENFREILAUFKÖRPER</b> im Novatec Einzelkarton	<b>CASSETTE BODY</b> in Novatec Box	 <div style="border: 1px solid black; padding: 5px; margin-top: 10px;"> <b>INFO</b>            Welcher Kassettenfreilaufkörper passt zu meiner Nabe? - Siehe Seite 247.            Which cassette body fits to my hub? - Just have a look on page 247.         </div>
SHIMANO TYP		SHIMANO TYPE	
<b>326283</b>	Typ ›B2‹ • <b>Aluminium</b> • für 8-11-fach <b>Shimano</b> Kassette (Road + MTB) • 4 Sperrklinken • mit <b>Anti-Bite-Guard</b>	›B2‹ type • <b>aluminium</b> • for 8-11 speed <b>Shimano</b> cassette (road + MTB) • 4 pawls • with <b>Anti-Bite-Guard</b>	 <div style="border: 1px solid black; padding: 2px; margin-top: 5px; width: fit-content;"> <b>ANTI-BITE-GUARD</b> </div>
		UVP 59,90 €	
<b>326294</b>	Typ ›B2‹ • <b>Aluminium</b> • für 8-11-fach <b>Shimano</b> Kassette (Road + MTB) • 4 Sperrklinken	›B2‹ type • <b>aluminium</b> • for 8-11 speed <b>Shimano</b> cassette (road + MTB) • 4 pawls	
		UVP 37,90 €	
<b>326274</b>	Typ ›F‹ • <b>Aluminium</b> • für 8-10-(Road) + 11(MTB)-fach <b>Shimano</b> Kassette • <b>5 Sperrklinken</b>	›F‹ type • <b>aluminium</b> • for 8-10 (road) + 11 (MTB) speed <b>Shimano</b> cassette • <b>5 pawls</b>	
		UVP 49,90 €	
<b>326292</b>	Typ ›A2‹ • <b>Aluminium</b> • für 8-11-fach <b>Shimano</b> Kassette (Road + MTB)	›A2‹ type • <b>aluminium</b> • for 8-11 speed <b>Shimano</b> cassette (road + MTB)	
		UVP 36,90 €	
<b>325725</b>	Typ ›B1‹ • <b>Aluminium</b> • für 8-10-(Road) + 11(MTB)-fach <b>Shimano</b> Kassette • 4 Sperrklinken	›B1‹ type • <b>aluminium</b> • for 8-10 (road) + 11 (MTB) speed <b>Shimano</b> cassette • 4 pawls	
		UVP 36,90 €	
<b>325285</b> 50	Typ ›B LS‹ • für 8-10-(Road) + 11(MTB)-fach <b>Shimano</b> Kassette	›B LS‹ type • for 8-10 (road) + 11 (MTB) speed <b>Shimano</b> cassette	
		UVP 36,90 €	
CAMPAGNOLO TYP		CAMPAGNOLO TYPE	
<b>325283</b>	Typ ›A‹ • <b>Aluminium</b> • für 9-12-fach <b>Campagnolo</b> Kassette	›A‹ type • <b>aluminium</b> • for 9-12-speed <b>Campagnolo</b> cassette	
		UVP 42,90 €	
<b>325706</b>	Typ ›B1‹ • <b>Aluminium</b> • für 9-12-fach <b>Campagnolo</b> Kassette	›B1‹ type • <b>aluminium</b> • for 9-12-speed <b>Campagnolo</b> cassette	
		UVP 42,90 €	
<b>326266</b> 50	Typ ›B1‹ • <b>Aluminium</b> • für 13-fach <b>Campagnolo</b> Kassette	›B1‹ type • <b>aluminium</b> • for 13-speed <b>Campagnolo</b> cassette	
		UVP 59,90 €	

# KASSETTENFREILAUFKÖRPER, UMRÜSTSETS CASSETTE BODIES, CONVERSION KITS

ART.-NR.	BESCHREIBUNG	DESCRIPTION	
<b>SRAM TYP</b>		<b>SRAM TYPE</b>	
<b>326286</b> 100	XD Drive: für <b>Sram</b> XG-Kassetten  Typ ›XX1‹ • <b>Aluminium</b> • <b>6 Sperrklinken</b> • im Polybeutel	XD Drive: for <b>Sram</b> XG cassettes  ›XX1‹ type • <b>aluminium</b> • <b>6 pawls</b> • in PE bag	  UVP 82,90 €
<b>326031</b>	Typ ›F‹ • <b>3 Sperrklinken</b> • im Novatec Einzelkarton	›F‹ type • <b>3 pawls</b> • in Novatec box	  UVP 49,90 €
<b>326293</b> 50	Typ ›B‹ • 4 Sperrklinken • im Novatec Einzelkarton	›B‹ type • 4 pawls • in Novatec box	  UVP 57,90 €
<b>326272</b> 50	XDR Drive: für 11-/12-fach <b>Sram</b> XG-Kassette  Typ ›B‹ • <b>Aluminium</b> • schwarz • im Novatec Einzelkarton	XDR Drive: for 11/12 speed <b>Sram</b> XG-cassette  ›B‹ type • <b>aluminium</b> • black • in Novatec box	  UVP 69,90 €



## INFO WELCHES UMRÜSTSET BENÖTIGE ICH? WHICH CONVERSION KIT DO I NEED?

Vorderradnabe front hub	5 mm	9 mm	12 mm	15 mm	20 mm	Hinterradnabe rear hub	5x135	10x135	12x135	12x142
D411	320290		320107			D412	320291			
D791	320117	320118	320119	320120		D792	320112	320079	320080	320081
D791-CL	320281			320098		D792-CL	326282			
XD611-CL	320110	320092	320111	320093		XD612	320112	320079	320080	320081
D541	320094			320293		D542				320069
D101						D102				
D201	320117	320118	320119	320297		D202	320292			325472
D881	320094			320293	325897	Diablo	320095			320096
XD641SB-B15					320123	Flowtrail	320095			320096
30 Disc	320117	320118	320119	320120		Alpine	320095			320096
Diablo	320094			320293	325897	Dragon	320095			320096
Diablo XL					320123	Demon				
Flowtrail	320094			320293	325897	CXD 4.0	320112	320079	320080	320081
Alpine	320094			320293	325897	Jetfly Disc 4.0	320112	320079	320080	320081
Dragon	320094			320293	325897	R3 Disc 3.0	320112	320079	320080	320081
Demon	320094			320293	325897	R3 Disc 4.0	320291			
CXD 4.0	320117	320118	320119	320120						
Jetfly Disc 4.0	320117	320118	320119	320120						
R3 Disc 3.0/4.0	320290		320107							

**INFO** **WELCHER KASSETTENFREILAUFKÖRPER PASST ZU MEINER NABE/LAUFRAD?**  
**WHICH CASSETTE BODY FITS TO MY HUB RESP. WHEEL SET?**

Art. Nabe/Laufrad art. hub/wheelset	Modell Nabe/Laufrad model hub / wheelset	Body- Type	Shimano	Microspline	Campagnolo	XD-Drive (Sram)	XDR-Drive
321405	D142SB-X12	S5	326288	-	-	-	-
325158	F162SB-11S	A2	326292	-	325283	-	-
325159	F162SB-11S	A2	326292	-	325283	-	-
325198	D722SB-11S	B2	326294, 326283 with ABG	-	325706	326293	326272
326080	F482SB-11S	B2	326294	-	325706	-	326272
326081	F482SB-11S	B2	326294	-	325706	-	326272
326082	F482SB-11S	B2	326294	-	325706	-	326272
326088	F172SB-11S	A2	326292	-	325283	-	-
326089	F172SB-11S	A2	326292	-	325283	-	-
326101	D042SB	A	325281	-	325283	-	-
326118	D712SB-B12	B1	325725	-	-	326293	326272
326131	D102SB	B	325285	-	-	326293	326272
326134	D202SB	B1	325725	-	-	326293	326272
326151	DH82SB	B	325285	-	-	326393	326272
326181	D542SB	XS	-	-	-	-	-
326321	D042SB	A	325281	-	-	-	-
326323	D042SB	A	325281	-	-	-	-
326354	D772SB-11S	B2	326294, 326283 with ABG	-	-	326293	326272
326355	D772SB-11S	B2	326294, 326283 with ABG	-	-	326293	326272
326356	D772SB-11S	B2	326294, 326283 with ABG	-	-	326293	326272
326361	D772SB-11S	B2	326294, 326283 with ABG	-	-	326293	326272
326362	D772SB-11S	B2	326294, 326283 with ABG	-	-	326293	326272
326363	D772SB-11S	B2	326294, 326283 with ABG	-	-	326293	326272
326333	D772SB-11S	B2	326294, 326283 with ABG	-	-	326293	326272
326335	D772SB-11S	B2	326294, 326283 with ABG	-	-	326293	326272
326450	D792SB-11S	B2	326294, 326283 with ABG	-	-	326293	326272
326452	D792SB-11S	B2	326294, 326283 with ABG	-	-	326293	326272
326453	D792SB-11S	B2	326294, 326283 with ABG	-	-	326293	326272
326454	D792SB-11S	B2	326294, 326283 with ABG	-	-	326293	326272
326455	D792SB-11S	B2	326294, 326283 with ABG	-	-	326293	326272
326456	D792SB-11S	B2	326294, 326283 with ABG	-	-	326293	326272
326460	D792SB-11S	B2	326294, 326283 with ABG	-	-	326293	326272
326461	D792SB-11S	B2	326294, 326283 with ABG	-	-	326293	326272
326127	D462SB-B12	F	326274	326268	-	326031	-
326184	D462SB-SL-B12/A-53S-11S	F	326274	326268	-	326031	-
321440	D162SB-SL-X12	F (Loose ball)		-	-	-	-
326375	FS62CB-11S	B2	326294	-	-	-	326272
326379	D412CB-11S	B2	326294	-	-	326293	326272
326501	DS462SB-A5A-B12	F	326274	-	-	326031	-
326502	XDS642SB-B12-ABG	X4	326296	-	-	326286	-
326572	D932SB-B12	E		-	-	326282	-
384126	R5 Clincher	D2	326297	-	326298	-	-
384213	R3 Clincher Disc 4.0	B2	326294, 326283 with ABG	-	-	326293	326272
384128	R3 Clincher Disc 3.0	D2	326297	-	326298	-	-
384144	Demon U2.1	X4	326296	-	-	326286	-
384159	Thirty U1.1			-	-	-	-
384179	Jetfly Disc 4.0	B2	326294, 326283 with ABG	-	-	326293	326272
384181	CXD 4.0	B2	326294, 326283 with ABG	-	-	326293	326272
384182	Jetfly SL U1.1	D2	326297	-	326298	-	-
384184	Thirty Disc 1.1			-	-	-	-
384236	Flowtrail 2.1 - Boost	X4	326296	-	-	326286	-
384237	Flowtrail 2.1 - Boost	X4	326296	-	-	326286	-
384238	Alpine U2.1 - Boost	X4	326296	-	-	326286	-
384239	Alpine U2.1 - Boost	X4	326296	-	-	326286	-
384240	Diablo XL U2.1 - Boost	X4	326296	-	-	326286	-

# INDUSTRIEKUGELLAGER SEALED BEARINGS

ART.-NR.	BESCHREIBUNG	DESCRIPTION				
50	<b>ERSATZKUGELLAGER</b> <b>Industriekugellager</b> , zum Beispiel für <ul style="list-style-type: none"> <li>• Novatec Naben, linker/rechter Flansch</li> <li>• Novatec Kassettenfreilaufkörper</li> </ul>	<b>REPLACEMENT BEARINGS</b> <b>sealed bearings</b> , for example for <ul style="list-style-type: none"> <li>• Novatec hubs, left and right flange</li> <li>• Novatec cassette body</li> </ul>	Art. 327011 ind. spec. 6902 Innen/Außen-Ø 15/28 mm	Art. 327012 ind. spec. 6000 Innen/Außen-Ø 10/26 mm		
Art. 327013 ind. spec. 6901 Innen/Außen-Ø 12/24 mm	Art. 327014 ind. spec. 6001 Innen/Außen-Ø 12/28 mm	Art. 327015 ind. spec. 699 Innen/Außen-Ø 9/20 mm	Art. 327016 ind. spec. 6804 Innen/Außen-Ø 20/32 mm	Art. 327017 ind. spec. 609RS Innen/Außen-Ø 9/24 mm	Art. 327018 ind. spec. 6802 Innen/Außen-Ø 12/24 mm	Art. 327019 ind. spec. 15267 Innen/Außen-Ø 15/26 mm
						
Model	left flange	art.	right flange	art.	cassette body	
A Type Campy					2 x 327013	
A Type Shimano					2 x 327013	
B Type Shimano					2 x 327011	
B1 Campy					2 x 327018	
B1 Shimano					2 x 327011	
B2 Type					2 x 327011	
A2 Type					2 x 327013	
F Type Shimano					2 x 327019, 1 x 327011	
F Type Sram					3 x 327019	
A141SB	609RS x 1	327017	609RS x 1	327017	X	
A165SBT	6000 x 1	327012	6000 x 1	327012	X	
A166SBT	6000 x 1	327012	6000 x 1	327012	X	
A171SB	609RS x 1	327017	609RS x 1	327017	X	
A291SB	699 x 1	327015	699 x 1	327015	X	
A565SBT	6000 x 1	327012	6000 x 1	327012	X	
A566SBT	6000 x 1	327012	6000 x 1	327012	X	
AS61CB	699 x 1	327015	699 x 1	327015	X	
D032SB	6001 x 1	327014	6001 x 1	327014	2 x 327014	
D041SB	6001 x 1	327014	6001 x 1	327014	X	
D042SB	6001 x 1	327014	6001 x 1	327014	2 x 327014	
D101SB	6902 x 1	327011	6902 x 1	327011	2 x 327011	
D102SB	6902 x 1	327011	6902 x 1	327011	2 x 327011	
D142SB-X12	6902 x 1	327011			1 x 327019	
D162SB-SL-X12	6902 x 1	327011	6902 x 1	327011	only change complete cassette-body	
D201SB	6902 x 1	327011	6902 x 1	327011	X	
D202SB	6902 x 1	327011	6902 x 1	327011	2 x 327011	
D252SB	6001 x 1	327014	6001 x 1	327014	2 x 327014	
D411CB	6803 x 1		6803 x 1		X	
D412CB	15267 x 1	327019	15267 x 1	327019	2 x 327019	
D462SB	6902 x 1	327011	6902 x 1	327011	3 x 327019	
D462SB-B12	6902 x 1	327011	6902 x 1	327011	3 x 327019	
D541SB	6804 x 1	327016	6804 x 1	327016	X	
D542SB	6902 x 1	327011	6809 x 1		2 x 327011	
D711SB	6902 x 1	327011	6902 x 1	327011	X	
D712SB	6902 x 1	327011	6902 x 1	327011	2 x 327011	
D712SB/S4S-B12	6902 x 1	327011	6902 x 1	327011	2 x 327011	
D722SB	6902 x 1	327011	6902 x 1	327011	2 x 327011	
D771SB	6902 x 1	327011	6902 x 1	327011	X	
D772SB	6902 x 1	327011	6902 x 1	327011	2 x 327011	
D791SB	6902 x 1	327011	6902 x 1	327011	X	
D791SB-B12	6902 x 1	327011	6902 x 1	327011	X	
D792SB	6902 x 1	327011	6902 x 1	327011	2 x 327011	
D811SB-15	6902 x 1	327011	6902 x 1	327011	X	
D881SB	6804 x 1	327016	6804 x 1	327016	X	
D882SB	6902 x 1	327011	6902 x 1	327011	2 x 327011	
D932SB-B12	6902 x 1	327011	6902 x 1	327011	2 x 327018	
DH61SB	6804 x 1	327016	6804 x 1	327016	X	
DH82SB	6902 x 1	327011	6902 x 1	327011	2 x 327011	
F162SB	6001 x 1	327014	6001 x 1	327014	2 x 327013	
F172SB	6901 x 1	327013	6001 x 1	327014	2 x 327013	
F482SB	6802 x 1	327018	6902 x 1	327011	2 x 327011	
FS62CB	6802 x 1	327018	15267 x 1	327019	2 x 327019	
XDS641SB-B15	6804 x 1	327016	6804 x 1	327016	X	
XDS642SB-B12-ABG	6903 x 1	327021	6903 x 1	327021	2 x #17287	







**311878** passend für Exustar Pedale Art. 311855,  
Maße: außen 12,94 mm, innen  
5,67 mm, Dicke 4,97 mm

suitable for Exustar pedals art. 311855,  
size: outside 12.94 mm, inside 5.67 mm,  
width 4.97 mm  
UVP 9,90 €





ind. spec. 686ZZ  
Innen/Außen-Ø 5,67/12,94 mm



ART.-NR.	BESCHREIBUNG	DESCRIPTION	
	<p><b>STECKACHSE MIT HEBEL</b></p> <ul style="list-style-type: none"> <li>Aluminium</li> <li>Ausrichtung des Hebels auch in geschlossenem Zustand änderbar</li> <li>im Polybeutel mit Novatec Euroloch-header</li> </ul> <p>›QR269F‹</p>	<p><b>THRU AXLE WITH LEVER</b></p> <ul style="list-style-type: none"> <li>aluminium</li> <li>adjustable position of lever even when closed</li> <li>in PE bag with Novatec eurohole header</li> </ul> <p>›QR269F‹</p>	 
<b>321086</b> 50	<ul style="list-style-type: none"> <li>Einbaumaß 12 x 100 mm</li> <li>M12 x Länge 118,5 mm</li> <li>Gewindesteigung 1,5 mm</li> <li>Gewindelänge 10,5 mm</li> <li>passend für z. B. Art. 391570</li> </ul>	<ul style="list-style-type: none"> <li>OLD 12 x 100 mm</li> <li>M12 x length 118.5 mm</li> <li>thread pitch: 1.5 mm</li> <li>thread length: 10.5 mm</li> <li>suitable for e. g. art. 391570</li> </ul> <p>UVP 34,90 €</p>	
<b>321097</b> 50	<ul style="list-style-type: none"> <li>Einbaumaß 15 x 100 mm</li> <li>M15 x Länge 148 mm</li> <li>Gewindesteigung 1,5 mm</li> <li>Gewindelänge 10 mm</li> <li>passend für z. B. Art. 395040 und diverse Rockshox Gabeln</li> </ul>	<ul style="list-style-type: none"> <li>OLD 15 x 100 mm</li> <li>M15 x length 148 mm</li> <li>thread pitch: 1.5 mm</li> <li>thread length: 10 mm</li> <li>suitable for e. g. art. 395040 and other Rockshox forks</li> </ul> <p>UVP 34,90 €</p>	
<b>321096</b> 50	<p>›QR269R‹</p> <ul style="list-style-type: none"> <li>Einbaumaß 142 mm (X12)</li> <li>M12 x Länge 166 mm</li> <li>Gewindesteigung 1,5 mm</li> <li>Gewindelänge 10 mm</li> </ul>	<p>›QR269R‹</p> <ul style="list-style-type: none"> <li>OLD 142 mm (X12)</li> <li>M12 x length 166 mm</li> <li>thread pitch: 1.5 mm</li> <li>thread length: 10 mm</li> </ul> <p>UVP 34,90 €</p>	
<b>321070</b> 100	<p>›QR264 SYNTACE‹</p> <ul style="list-style-type: none"> <li>Einbaumaß 142 mm (X12)</li> <li>M12 x Länge 163 mm</li> <li>Gewindesteigung 1 mm</li> <li>Gewindelänge 20 mm</li> </ul>	<p>›QR264 SYNTACE‹</p> <ul style="list-style-type: none"> <li>OLD 142 mm (X12)</li> <li>M12 x length 163 mm</li> <li>thread pitch: 1 mm</li> <li>thread length: 20 mm</li> </ul> <p>UVP 34,90 €</p>	
<b>321071</b> 100	<p>›QR264 SHIMANO‹</p> <ul style="list-style-type: none"> <li>Einbaumaß 142 mm (X12)</li> <li>M12 x Länge 172 mm</li> <li>Gewindesteigung 1,5 mm</li> <li>Gewindelänge 18 mm</li> <li>für Shimano-X12 (kein original Shimano Ersatzteil)</li> <li>z. B. für 661953 ff, ...</li> </ul>	<p>›QR264 SHIMANO‹</p> <ul style="list-style-type: none"> <li>OLD 142 mm (X12)</li> <li>M12 x length 172 mm</li> <li>thread pitch: 1.5 mm</li> <li>thread length: 18 mm</li> <li>for Shimano-X12 (no original Shimano spare part)</li> <li>e. g. for 661953 et seq., ...</li> </ul> <p>UVP 34,90 €</p>	
	<p><b>Steckachse mit anderem Durchmesser, Länge, ... auf Anfrage erhältlich</b></p>	<p><b>Thru axle with other diameter, length, ... available on request</b></p>	

ART.-NR.	BESCHREIBUNG	DESCRIPTION	
<p><b>321195</b> 200</p> <p><b>321138</b> 200</p> <p><b>NEW</b></p>	<p><b>STECKACHSE MIT HEBEL</b></p> <ul style="list-style-type: none"> <li>• versenkbarer Schnellspann-Hebel</li> <li>• <b>Aluminium</b></li> <li>• Gewindesteigung 1,5 mm</li> <li>• Montageverpackung</li> </ul> <p>›SCRAX B-12 148 QR‹</p> <ul style="list-style-type: none"> <li>• <b>Einbaumaß 148 mm</b></li> <li>• M12 x Länge 178 mm</li> <li>• nur <b>55 g</b></li> <li>• Gewindelänge 18 mm</li> <li>• z. B. für MTB- oder E-Bike-Rahmen</li> </ul> <p>›SCRAX B-12 142 QR‹</p> <ul style="list-style-type: none"> <li>• <b>Einbaumaß 142 mm</b></li> <li>• M12 x Länge 157 mm</li> <li>• nur <b>53 g</b></li> <li>• Gewindelänge 10 mm</li> <li>• z. B. für Gravel-Rahmen Art. 666141-5</li> </ul>	<p><b>THRU AXLE WITH LEVER</b></p> <ul style="list-style-type: none"> <li>• <b>hidden</b> QR lever</li> <li>• <b>aluminium</b></li> <li>• thread pitch: 1.5 mm</li> <li>• OEM</li> </ul> <p>›SCRAX B-12 148 QR‹</p> <ul style="list-style-type: none"> <li>• <b>OLD 148 mm</b></li> <li>• M12 x length 178 mm</li> <li>• only <b>55 g</b></li> <li>• thread length: 18 mm</li> <li>• e. g. for MTB or e-bike frames</li> </ul> <p>›SCRAX B-12 142 QR‹</p> <ul style="list-style-type: none"> <li>• <b>OLD 142 mm</b></li> <li>• M12 x length 157 mm</li> <li>• only <b>53 g</b></li> <li>• thread length: 10 mm</li> <li>• e. g. for gravel frame art. 666141-5</li> </ul> <p>UVP 36,90 €</p>	 <div data-bbox="1181 414 1380 459"> <p><b>BOOST</b> OLD 148</p> </div> <div data-bbox="1181 481 1252 571">  <p>55 g</p> </div> <div data-bbox="1396 414 1556 571">  </div> <div data-bbox="1181 582 1556 705">  <p>178 mm</p> </div> <div data-bbox="1181 728 1252 817">  <p>53 g</p> </div> <div data-bbox="1181 828 1556 952">  <p>157 mm</p> </div>
<p><b>321137</b> 100</p> <p><b>NEW</b></p>	<p><b>STECKACHSE</b></p> <ul style="list-style-type: none"> <li>• <b>Einbaumaß 148 mm</b></li> <li>• mit Schnellspanner</li> <li>• Aluminium</li> <li>• Boost Standard</li> <li>• M12 x Länge <b>173 mm</b></li> <li>• Gewindesteigung 1,0 mm</li> <li>• Gewindelänge 14 mm</li> <li>• für Rahmen Art. 661250-3</li> <li>• Montageverpackung</li> </ul>	<p><b>THRU AXLE</b></p> <ul style="list-style-type: none"> <li>• <b>OLD 148 mm</b></li> <li>• with QR</li> <li>• aluminium</li> <li>• boost standard</li> <li>• M12 x length <b>173 mm</b></li> <li>• thread pitch: 1.0 mm</li> <li>• thread length: 14 mm</li> <li>• for frames art. 661250-3</li> <li>• OEM</li> </ul> <p>UVP 31,90 €</p>	 <p>173 mm</p>
<p><b>321130</b></p> <p><b>321131</b> 200</p>	<p><b>STECKACHSE</b></p> <ul style="list-style-type: none"> <li>• <b>Einbaumaß 148 mm</b></li> <li>• <b>Innensechskant Fixierung</b></li> <li>• Gewindesteigung 1,0 mm</li> <li>• Gewindelänge 12,7 mm</li> <li>• mit Innengewinde M5 x P0,8 auf beiden Seiten</li> <li>• Montageverpackung</li> </ul> <p>M12 x Länge <b>186 mm</b></p> <p>Flat-Achse</p> <p>M12 x Länge <b>170 mm</b></p> <p>Cone-Achse</p>	<p><b>THRU AXLE</b></p> <ul style="list-style-type: none"> <li>• <b>OLD 148 mm</b></li> <li>• <b>allen screw fixation</b></li> <li>• thread pitch: 1.0 mm</li> <li>• thread length: 12.7 mm</li> <li>• with inner thread M5 x P0.8 on both sides</li> <li>• OEM</li> </ul> <p>M12 x length <b>186 mm</b></p> <p>flat axle</p> <p>M12 x length <b>170 mm</b></p> <p>cone axle</p> <p>UVP 24,90 €</p> <p>UVP 24,90 €</p>	<div data-bbox="1189 1344 1380 1388"> <p><b>BOOST</b> OLD 148</p> </div> <div data-bbox="1181 1456 1556 1624">  <p>186 mm</p> </div> <div data-bbox="1181 1657 1556 1825">  <p>170 mm</p> </div>
<p><b>321193</b> 200</p> <p><b>NEW</b></p>	<p>›SCRAX B-12 148‹</p> <ul style="list-style-type: none"> <li>• <b>Einbaumaß 148 mm</b></li> <li>• Boost Standard</li> <li>• <b>6 mm Innensechskant Fixierung</b></li> <li>• M12 x Länge <b>178 mm</b></li> <li>• Gewindesteigung: 1,5 mm</li> <li>• Gewindelänge: 20 mm</li> <li>• Montageverpackung</li> </ul>	<p>›SCRAX B-12 148‹</p> <ul style="list-style-type: none"> <li>• <b>OLD 148 mm</b></li> <li>• boost standard</li> <li>• <b>6 mm allen screw fixation</b></li> <li>• M12 x length <b>178 mm</b></li> <li>• thread pitch: 1.5 mm</li> <li>• thread length: 20 mm</li> <li>• OEM</li> </ul> <p>UVP 19,90 €</p>	  <p>178 mm</p> 









ART.-NR.	BESCHREIBUNG	DESCRIPTION	
  <b>321009</b> 100/25 set  <b>321030</b> 100 set	<b>SCHNELLSPANNER-SET</b> <ul style="list-style-type: none"> <li>mit <b>Spezienschlüssel</b> (Art. 321000) als <b>Diebstahlschutz</b></li> <li>für Vorderradnabe mit Einbaumaß 100 mm, für Hinterradnabe mit Einbaumaß 130 -135 mm und für Sattelstützklemme mit Einbaumaß 28 - 32 mm</li> <li>auf <b>Tranz X</b> Eurolochkarte</li> </ul> schwarz  silber	<b>QUICK RELEASE SET</b> <ul style="list-style-type: none"> <li>with <b>special key</b> (art. 321000) as <b>thief protection</b></li> <li>for front hub with OLD 100 mm, for rear hub with OLD 130 - 135 mm and for seat post clamp with OLD 28 - 32 mm</li> <li>on <b>Tranz X</b> eurohole card</li> </ul> black  silver   UVP 18,90 €	
<b>321116</b>   <b>321117</b> 400  <b>321135</b> 200	<b>SCHNELLSPANNER</b> <b>Diebstahlschutz</b> , da mit <b>Innensechskant-Fixierung</b> <ul style="list-style-type: none"> <li>für <b>Vorderradnabe</b></li> <li>Einbaumaß: 100 mm</li> <li>Montageverpackung</li> </ul> <ul style="list-style-type: none"> <li>für <b>Hinterradnabe</b></li> <li>Einbaumaß: 130-135 mm</li> <li>Montageverpackung</li> </ul> <ul style="list-style-type: none"> <li><b>Set für Vorder- und Hinterradnabe</b></li> <li>Einbaumaße: 100 mm / 130-135 mm</li> <li>auf M-Wave Eurolochkarte</li> </ul>	<b>QUICK RELEASE</b> <b>theft protection</b> due to <b>allen screw fixation</b> <ul style="list-style-type: none"> <li>for <b>front hub</b></li> <li>OLD: 100 mm</li> <li>OEM</li> </ul> UVP 4,90 €  <ul style="list-style-type: none"> <li>for <b>rear hub</b></li> <li>OLD: 130-135 mm</li> <li>OEM</li> </ul> UVP 4,90 €  <ul style="list-style-type: none"> <li><b>set for front and rear hub</b></li> <li>OLD: 100 mm / 130-135 mm</li> <li>on M-Wave eurohole card</li> </ul> UVP 9,90 €	







LINK TO PERFECTION

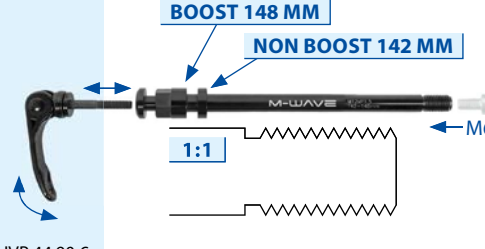
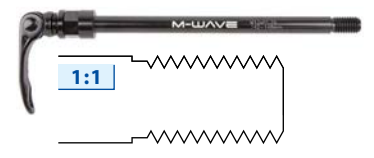
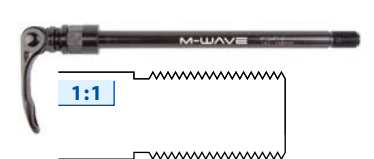

[www.kmc.messingschlager.com](http://www.kmc.messingschlager.com)

ART.-NR. 	BESCHREIBUNG	DESCRIPTION	
<p><b>321122</b></p> <p><b>321123</b> 200/50</p>	<p><b>SCHNELLSPANNER</b></p> <ul style="list-style-type: none"> <li>• Aluminium</li> <li>• schwarz eloxiert</li> <li>• Montageverpackung</li> </ul> <p>für Vorderradnabe • Einbaumaß: 100 mm • nur <b>39 g</b></p> <p>für Hinterradnabe • Einbaumaß: 135 mm • nur <b>45 g</b></p>	<p><b>QUICK RELEASE</b></p> <ul style="list-style-type: none"> <li>• aluminium</li> <li>• black anodised</li> <li>• OEM</li> </ul> <p>for front hub • OLD: 100 mm • only <b>39 g</b></p> <p>for rear hub • OLD 135 mm • only <b>45 g</b></p>	   <p>UVP 6,90 €</p>
<p><b>321060</b> 50 set</p>	<p>Set aus Schnellspannern für Vorderradnabe (Art. 321122) und für Hinterradnabe (Art. 321123)</p> <ul style="list-style-type: none"> <li>• nur <b>84 g/Set</b></li> <li>• auf Novatec Eurolochkarte</li> </ul>	<p>Set of quick releases for front hub (art. 321122) and for rear hub (art. 321123)</p> <ul style="list-style-type: none"> <li>• only <b>84 g/set</b></li> <li>• on Novatec eurohole card</li> </ul>	   <p>UVP 12,90 €</p>
<p><b>321028</b></p> <p><b>321087</b> 250</p> <p><b>321191</b> <b>NEW</b> 500</p> <p><b>321025</b></p> <p><b>321088</b> 250</p> <p><b>321141</b> <b>NEW</b> 500</p>	<p><b>SCHNELLSPANNER</b></p> <ul style="list-style-type: none"> <li>• Aluminium-Hebel</li> <li>• Montageverpackung</li> </ul> <p>für Vorderradnabe mit Einbaumaß 100 mm</p> <p>silber</p> <p>schwarz</p> <p>schwarz, alternatives Design</p> <p>für Hinterradnabe mit Einbaumaß 135 mm</p> <p>silber</p> <p>schwarz</p> <p>schwarz, alternatives Design</p>	<p><b>QUICK RELEASE</b></p> <ul style="list-style-type: none"> <li>• aluminium lever</li> <li>• OEM</li> </ul> <p>for front hub with OLD 100 mm</p> <p>silver</p> <p>black</p> <p>black, alternative design</p> <p>for rear hub with OLD 135 mm</p> <p>silver</p> <p>black</p> <p>black, alternative design</p>	 <p>UVP 2,90 €</p>  <p>UVP 2,90 €</p>

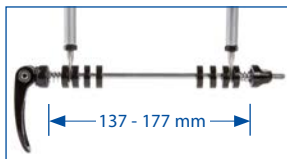

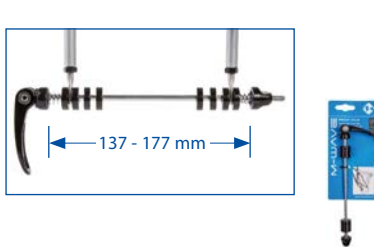
ART.-NR.	BESCHREIBUNG	DESCRIPTION	
	<p><b>STECKACHSE FÜR ANHÄNGER-KUPPLUNG</b> ›STALWART AXLE‹</p> <ul style="list-style-type: none"> <li>durch Innengewinde auch zur <b>Montage von Gepäckträgern an Steckachsen</b> geeignet</li> <li>zur <b>werkzeuglosen Montage von Standard Fahrrad-Anhänger-Kupplungen</b> an <b>12 mm Steckachs-naben</b></li> <li><b>2 in 1:</b> durch 6 mm Distanzscheibe passend für 12 mm Steckachs-naben mit <b>142 mm</b> Einbaumaß und für <b>Boost-Naben</b> mit <b>148 mm</b> Einbaumaß</li> <li>Aluminium</li> <li>mit Schnellspanner</li> <li>auch <b>ohne Schnellspanner als saubere Lösung</b> für Steckachsen nutzbar</li> <li>mit <b>zusätzlichem Innengewinde</b> für M6-Schraube für z. B. Gepäckträgermontage</li> <li>mit zusätzlichen Unterlegscheiben zur <b>Einstellung der Schnellspannhebel-Position</b></li> <li>auf M-Wave Eurolochkarte</li> </ul>	<p><b>THRU AXLE FOR TRAILER MOUNT</b> ›STALWART AXLE‹</p> <ul style="list-style-type: none"> <li>due to the internal thread also suitable for <b>mounting carriers to thru axles</b></li> <li>for <b>toolless mounting of standard bicycle trailer adapters</b> at <b>12 mm thru axle hubs</b></li> <li><b>2 in 1:</b> by 6 mm spacer suitable for 12 mm thru axle hubs with OLD <b>142 mm</b> and for <b>boost hubs</b> with OLD <b>148 mm</b></li> <li>aluminium</li> <li>with QR</li> <li>also usable <b>without QR as clean solution</b> for quick-release axle</li> <li>with <b>additional internal thread</b> for M6 screw for e. g. luggage rack mounting</li> <li>with additional spacers for <b>adjusting the QR lever position</b></li> <li>on M-Wave eurohole card</li> </ul>	<p><b>BOOST</b></p>  <p><b>BOOST 148 MM</b> <b>NON BOOST 142 MM</b></p>  <p>1:1</p>  <p>1:1</p>  <p>UVP 44,90 €</p> <p>UVP 44,90 €</p> <p>UVP 44,90 €</p>
640140	<ul style="list-style-type: none"> <li><b>Shimano Type</b> (kein original Shimano Ersatzteil)</li> <li>Gewindesteigung: P1.5 x T20</li> </ul>	<ul style="list-style-type: none"> <li><b>Shimano Type</b> (no original Shimano spare part)</li> <li>thread pitch: P1.5 x T20</li> </ul>	
640141	<ul style="list-style-type: none"> <li><b>Maxle Type</b> (kein original Maxle Ersatzteil)</li> <li>Gewindesteigung: P1.75 x T20</li> </ul>	<ul style="list-style-type: none"> <li><b>Maxle Type</b> (no original Maxle spare part)</li> <li>thread pitch: P1.75 x T20</li> </ul>	
640142 50	<ul style="list-style-type: none"> <li><b>Syntace Type</b> (kein original Syntace Ersatzteil)</li> <li>Gewindesteigung: P1.0 x T20</li> <li>mit konischer Verbindungsscheibe</li> </ul>	<ul style="list-style-type: none"> <li><b>Syntace Type</b> (no original Syntace spare part)</li> <li>thread pitch: P1.0 x T20</li> <li>with conical spacer</li> </ul>	
440490 100	<p><b>SCHNELLSPANNER</b></p> <ul style="list-style-type: none"> <li>zur <b>Montage von Gepäckträgern</b> an Räder:</li> <li>- <b>ohne Befestigungsösen</b> (z. B. Rennräder)</li> <li>- mit <b>hinderlichen Sitzrohr- oder Kettenstreben, Ausfallenden, ...</b></li> <li>passend auch für <b>Fahrradanhänger</b> Art. 640050, ...</li> <li>mit 8 je 5 mm breiten <b>Adapter-scheiben</b></li> <li><b>Aluminiumhebel</b></li> <li>Länge 210 mm</li> <li>für Nabeneinbaumaß: <math>\geq 130</math> mm</li> <li><b>Einklembreite: 137 mm - 177 mm</b> (in 5 mm Schritten)</li> <li>auf M-Wave Eurolochkarte</li> </ul> 	<p><b>QUICK RELEASE</b></p> <ul style="list-style-type: none"> <li>for <b>mounting of carriers</b> to bicycles:</li> <li>- <b>without mounting eyelets</b> (e. g. road bikes)</li> <li>- with <b>obstructive seat stays, chain stays, derailleur hangers, ...</b></li> <li>also suitable for <b>bicycle trailer</b> art. 640050, ...</li> <li>with 8 <b>adapters</b>, each 5 mm wide</li> <li><b>aluminium lever</b></li> <li>length 210 mm</li> <li>OLD: <math>\geq 130</math> mm</li> <li><b>clamp width: 137 - 177 mm</b> (in 5 mm steps)</li> <li>on M-Wave eurohole card</li> </ul>   <p>UVP 9,90 €</p>	 <p><b>M-WAVE</b></p> 











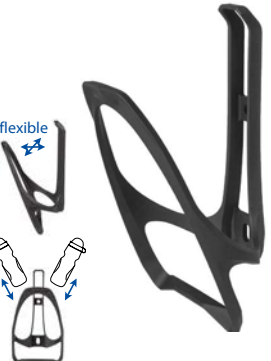

# BOTTLES

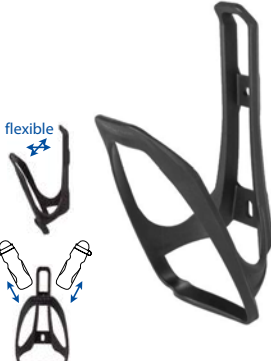





















ART.-NR.	BESCHREIBUNG	DESCRIPTION	
<b>340250</b> 24	<b>EDELSTAHL-TRINKFLASCHE</b> ›SBO 750‹ <ul style="list-style-type: none"> <li>• 750 ml</li> <li>• aus <b>Edelstahl</b></li> <li>• <b>umweltschützend</b>, da <b>wiederverwendbar</b></li> <li>• mit <b>Staubschutzkappenverschluss</b></li> <li>• mit <b>Dichtungsring</b></li> <li>• frei von Schadstoffen</li> <li>• <b>geruchs- und geschmacksneutral</b></li> <li>• auf <b>M-Wave Eurolochkarte</b></li> </ul>	<b>STAINLESS STEEL WATER BOTTLE</b> ›SBO 750‹ <ul style="list-style-type: none"> <li>• 750 ml</li> <li>• made of <b>stainless steel</b></li> <li>• <b>environment-friendly</b>, because <b>reusable</b></li> <li>• with <b>protection cap</b></li> <li>• with <b>sealing ring</b></li> <li>• free of contaminants</li> <li>• <b>odorless and neutral in taste</b></li> <li>• on <b>M-Wave eurohole card</b></li> </ul> <p style="text-align: right;"><small>according to FDA</small></p> <p style="text-align: right;">UVP 8,90 €</p>	  <p style="text-align: right;"><b>STAINLESS</b></p>
<b>340295</b> 24	<b>ALUMINIUM-TRINKFLASCHE</b> ›ABO 750‹ <ul style="list-style-type: none"> <li>• 750 ml</li> <li>• mit <b>Staubschutzkappenverschluss</b></li> <li>• mit <b>Dichtungsring</b></li> <li>• farbig sortiert</li> <li>• auf <b>M-Wave Eurolochkarte</b></li> </ul>	<b>ALUMINIUM WATER BOTTLE</b> ›ABO 750‹ <ul style="list-style-type: none"> <li>• 750 ml</li> <li>• with <b>protection cap</b></li> <li>• with <b>sealing ring</b></li> <li>• assorted colours</li> <li>• on <b>M-Wave eurohole card</b></li> </ul> <p style="text-align: right;">UVP 6,90 €</p>	 <p style="text-align: right;"><b>ALUMINIUM</b></p> 
<b>340290</b> <b>340291</b> <b>340292</b> <b>340293</b> 24	Montageverpackung silber schwarz rot blau	OEM silver black red blue <p style="text-align: right;">UVP 6,90 €</p>	 
<b>340340</b> 100	<b>ISOLIER-/THERMOFLASCHE</b> ›PBO 400-ISO‹ <ul style="list-style-type: none"> <li>• 400 ml</li> <li>• aus transparentem Kunststoff</li> <li>• mit <b>Isolierfolie</b></li> <li>• mit <b>abnehmbarem Staubschutzkappenverschluss</b></li> <li>• auf M-Wave Eurolochkarte</li> </ul>	<b>INSULATED/THERMO BOTTLE</b> ›PBO 400-ISO‹ <ul style="list-style-type: none"> <li>• 400 ml</li> <li>• made of transparent plastic</li> <li>• with <b>insulating foil</b></li> <li>• with <b>detachable protection cap</b></li> <li>• on M-Wave eurohole card</li> </ul> <p style="text-align: right;">UVP 8,90 €</p>	  
<b>NEW</b> <b>340450</b> <b>340452</b> 100	<b>ISOLIER-/THERMOFLASCHE</b> ›PBO 500-ISO‹ <ul style="list-style-type: none"> <li>• 500 ml</li> <li>• modernes Design</li> <li>• aus <b>hochwertigem Kunststoff</b></li> <li>• leichte Entnahme von Isolierung und Innenbehälter zur Reinigung</li> <li>• mit Staubschutzkappe</li> <li>• auf M-Wave Eurolochkarte</li> </ul>	<b>INSULATED/THERMO BOTTLE</b> ›PBO 500-ISO‹ <ul style="list-style-type: none"> <li>• 500 ml</li> <li>• modern design</li> <li>• <b>high quality plastic</b></li> <li>• easy removal of insulation and inner container for cleaning</li> <li>• with protection cap</li> <li>• on M-Wave eurohole card</li> </ul> <p style="text-align: right;">UVP 7,90 €</p>	   

ART.-NR.	BESCHREIBUNG	DESCRIPTION	
<b>340351</b> 50	<b>TRINKFLASCHE ›PBO 700-NS‹</b> <ul style="list-style-type: none"> <li>• 700 ml</li> <li>• mit <b>Anti-Rutsch</b>-Einlage</li> <li>• aus hochwertigem Kunststoff</li> <li>• abnehmbarer <b>Staubschutzkappenverschluss</b></li> <li>• silber/schwarz</li> <li>• mit <b>Skala</b></li> <li>• auf M-Wave Eurolochkarte</li> </ul>	<b>WATER BOTTLE ›PBO 700-NS‹</b> <ul style="list-style-type: none"> <li>• 700 ml</li> <li>• with <b>non-slip</b> inlay</li> <li>• high quality plastic</li> <li>• detachable <b>protection cap</b></li> <li>• silver/black</li> <li>• with <b>scale</b></li> <li>• on M-Wave eurohole card</li> </ul>	 <p><b>NON-SLIP</b></p>  <p>UVP 6,90 €</p>
<b>340365</b>   <b>340366</b> 50	<b>TRINKFLASCHE ›PBO 600-NS‹</b> <ul style="list-style-type: none"> <li>• 600 ml</li> <li>• mit <b>Anti-Rutsch</b>-Einlage</li> <li>• aus <b>hochwertigem</b> Kunststoff</li> <li>• mit <b>Staubschutzkappenverschluss</b></li> <li>• auf M-Wave Eurolochkarte</li> </ul> <p>weiß/schwarz</p> <p>silber/schwarz</p>	<b>WATER BOTTLE ›PBO 600-NS‹</b> <ul style="list-style-type: none"> <li>• 600 ml</li> <li>• with <b>non-slip</b> inlay</li> <li>• <b>high quality</b> plastic</li> <li>• with <b>protection cap</b></li> <li>• on M-Wave eurohole card</li> </ul> <p>white/black</p> <p>silver/black</p>	 <p><b>NON-SLIP</b></p>  <p>UVP 5,90 €</p>
<b>NEW</b>  <b>340440</b> <b>340442</b> 50	<b>TRINKFLASCHE</b> <ul style="list-style-type: none"> <li>• aus <b>hochwertigem Kunststoff</b></li> <li>• mit weichem <b>Big Flow Mundstück</b></li> <li>• auf M-Wave Eurolochkarte</li> </ul> <p><b>›PBO 1000‹, 1.000 ml, mit Skala</b></p> <p>schwarz</p> <p>weiß</p>	<b>WATER BOTTLE</b> <ul style="list-style-type: none"> <li>• <b>high quality plastic</b></li> <li>• with soft <b>big flow bite valve</b></li> <li>• on M-Wave eurohole card</li> </ul> <p><b>›PBO 1000‹, 1,000 ml, with scale</b></p> <p>black</p> <p>white</p>	 <p><b>1000 ML</b></p>  <p>UVP 5,90 €</p>
<b>340420</b> <b>340421</b> <b>340422</b> <b>340423</b> <b>340424</b> 100	<p><b>›PBO 750‹, 750 ml, mit Skala</b></p> <p>schwarz</p> <p>schwarz transparent</p> <p>weiß</p> <p>transparent</p> <p>blau transparent</p>	<p><b>›PBO 750‹, 750 ml, with scale</b></p> <p>black</p> <p>black transparent</p> <p>white</p> <p>transparent</p> <p>blue transparent</p>	 <p><b>750 ML</b></p>  <p>UVP 4,90 €</p>
<b>NEW</b>  <b>340425</b> <b>340426</b> <b>340427</b> <b>340428</b> <b>340429</b> 90	<p><b>›PBO 550‹, 550 ml, mit Skala</b></p> <p>schwarz</p> <p>schwarz transparent</p> <p>weiß</p> <p>transparent</p> <p>blau transparent</p>	<p><b>›PBO 550‹, 550 ml, with scale</b></p> <p>black</p> <p>black transparent</p> <p>white</p> <p>transparent</p> <p>blue transparent</p>	 <p><b>550 ML</b></p>  <p>UVP 3,90 €</p>
<b>NEW</b>  <b>340430</b> <b>340432</b> 130	<p><b>›PBO 350‹, 350 ml</b></p> <p>schwarz</p> <p>weiß</p>	<p><b>›PBO 350‹, 350 ml</b></p> <p>black</p> <p>white</p>	 <p><b>350 ML</b></p>  <p>UVP 3,90 €</p>





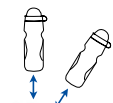

ART.-NR.	BESCHREIBUNG	DESCRIPTION	
<p>340212</p> <p>340213</p> <p>340214</p> <p>100</p>	<p><b>KINDERTRINKFLASCHE MIT HALTER</b></p> <ul style="list-style-type: none"> <li>• 300 ml Volumen</li> <li>• mit Motivaufklebern und Staubschutzkappe</li> <li>• <b>inkl. Halter</b> und gleichfarbigem Kabelbinder für <b>universelle Befestigungsmöglichkeiten</b> am Rahmen, Lenker, ...</li> <li>• Montageverpackung</li> </ul>	<p><b>CHILDREN WATER BOTTLE WITH CAGE</b></p> <ul style="list-style-type: none"> <li>• 300 ml volume</li> <li>• with design stickers and protection cap</li> <li>• <b>incl. cage</b> and cable tie in the same colour for <b>universal mounting possibilities</b> at the frame, handlebar, ...</li> <li>• OEM</li> </ul>	<p>VENTURA®</p> 
<p>341020</p> <p>50</p> <p><b>NEW</b></p>	<p><b>FLASCHENHALTER MIT MULTITOOL ›BC 99 TOOL‹</b></p> <ul style="list-style-type: none"> <li>• mit <b>integriertem Multitool</b> (9 Funktionen)</li> <li>• Glasfaserverstärkter Kunststoff (GFK)</li> <li>• <b>nur 99 g inkl. Multitool</b></li> <li>• inkl. Befestigungsschrauben</li> <li>• auf M-Wave Eurolochkarte</li> </ul>	<p><b>BOTTLE CAGE WITH MULTITOOL ›BC 99 TOOL‹</b></p> <ul style="list-style-type: none"> <li>• with <b>integrated multitool</b> (9 functions)</li> <li>• fiberglass reinforced plastic</li> <li>• <b>only 99 g incl. multitool</b></li> <li>• incl. fixing screws</li> <li>• on M-Wave eurohole card</li> </ul>	 <p>M-WAVE</p> 
<p>340908</p> <p>50/10</p>	<p><b>FLASCHENHALTER ›BC 19-C‹</b></p> <ul style="list-style-type: none"> <li>• modernes und funktionelles Design</li> <li>• <b>carbonfaserverstärkter</b> Kunststoff</li> <li>• superleicht, nur <b>19 g</b></li> <li>• inkl. Befestigungsschrauben</li> <li>• auf M-Wave Eurolochkarte</li> </ul>	<p><b>BOTTLE CAGE ›BC 19-C‹</b></p> <ul style="list-style-type: none"> <li>• modern and functional design</li> <li>• <b>carbon fiber</b> composite plastic</li> <li>• super light, only <b>19 g</b></li> <li>• incl. fixing screws</li> <li>• on M-Wave eurohole card</li> </ul>	<p><b>CARBON</b></p>  <p>M-WAVE</p> 
<p>340707</p> <p>50/10</p>	<p><b>FLASCHENHALTER ›BC 30-K‹</b></p> <ul style="list-style-type: none"> <li>• modernes und funktionelles Design</li> <li>• <b>hochwertiger Kunststoff</b></li> <li>• nur <b>30 g</b></li> <li>• <b>leichtes Herausnehmen und Einführen</b> der Flasche durch abgerundete Kanten</li> <li>• inkl. Befestigungsschrauben</li> <li>• auf M-Wave Eurolochkarte</li> </ul>	<p><b>BOTTLE CAGE ›BC 30-K‹</b></p> <ul style="list-style-type: none"> <li>• modern and functional design</li> <li>• <b>high quality plastic</b></li> <li>• only <b>30 g</b></li> <li>• <b>easy placement and removal</b> of the bottle by rounded brims</li> <li>• incl. fixing screws</li> <li>• on M-Wave eurohole card</li> </ul>	 <p>M-WAVE</p> 

ART.-NR. 	BESCHREIBUNG	DESCRIPTION	
<b>340720</b> 50/10	<b>FLASCHENHALTER ›BC VARIO SIDE‹</b> <ul style="list-style-type: none"> <li>• <b>Montageadapter</b> ermöglicht <b>links-</b> wie auch <b>rechtsseitige</b> Einführung und Entnahme der Flasche. Dadurch besonders geeignet für <b>E-Bike Rahmengenometrien</b> mit eingeschränktem Platz</li> <li>• <b>hochwertiger Kunststoff</b></li> <li>• nur 44 g</li> <li>• <b>leichtes Herausnehmen und Einführen</b> der Flasche durch nach außen abgerundete Kanten</li> <li>• universelle Passform</li> <li>• inkl. Befestigungsschrauben</li> <li>• auf M-Wave Eurolochkarte</li> </ul>	<b>BOTTLE CAGE ›BC VARIO SIDE‹</b> <ul style="list-style-type: none"> <li>• <b>mounting adapter</b> enables the bottle to be placed and removed from the <b>left</b> and the <b>right side</b>. Therefore particularly suitable for <b>e-bike frame geometries</b> with limited space</li> <li>• <b>high quality plastic</b></li> <li>• only 44 g</li> <li>• <b>easy placement and removal</b> of the bottle by to the outside rounded brims</li> <li>• universal fitting</li> <li>• incl. fixing screws</li> <li>• on M-Wave eurohole card</li> </ul> <p style="text-align: right;">UVP 7,90 €</p>	
<b>340916</b> 100	<b>FLASCHENHALTER ›BC 21‹</b> <ul style="list-style-type: none"> <li>• hochwertiger Kunststoff</li> <li>• nur <b>21 g</b></li> <li>• <b>leichtes</b> Herausnehmen und Einführen der Flasche durch abgerundete Kanten</li> <li>• <b>gute Passform</b> durch flexible Seitenteile</li> <li>• <b>Non-Slip</b> Gummieinlage erschwert das Herausfallen der Flasche</li> <li>• auf M-Wave Eurolochkarte</li> </ul>	<b>BOTTLE CAGE ›BC 21‹</b> <ul style="list-style-type: none"> <li>• high quality plastic</li> <li>• only <b>21 g</b></li> <li>• <b>easy</b> placement and removal of the bottle by rounded brims</li> <li>• <b>good fitting</b> because of flexible side parts</li> <li>• <b>non-slip</b> rubber prevents the bottle from falling out</li> <li>• on M-Wave eurohole card</li> </ul> <p style="text-align: right;">UVP 5,90 €</p>	
<b>340790</b> 100/10	<b>FLASCHENHALTER ›BC VARIO‹</b> <ul style="list-style-type: none"> <li>• fast <b>unzerstörbares</b>, hochwertiges, schwarzes Nylonmaterial</li> <li>• Trinkflasche sowohl <b>von oben</b>, als auch <b>von vorne</b> einsteckbar</li> <li>• inklusive 2 Befestigungsschrauben</li> <li>• auf M-Wave Eurolochkarte</li> </ul>	<b>BOTTLE CAGE ›BC VARIO‹</b> <ul style="list-style-type: none"> <li>• almost <b>indestructible</b>, high quality, black nylon</li> <li>• water bottle can be put in <b>from top</b> or <b>front side</b></li> <li>• incl. 2 mounting screws</li> <li>• on M-Wave eurohole card</li> </ul> <p style="text-align: right;">UVP 4,90 €</p>	
<b>340719</b> 125	<b>FLASCHENHALTER ›BC 33‹</b> <ul style="list-style-type: none"> <li>• <b>hochwertiges</b>, schwarzes <b>Nylonmaterial</b></li> <li>• Flasche kann leicht von Rechts- und Linkshändern entnommen werden</li> <li>• <b>flexible</b> und universelle Anpassung an verschiedene Flaschenformen</li> <li>• leichtes <b>Einführen und Herausnehmen</b> der Flasche durch nach außen abgerundete Ränder</li> <li>• nur <b>33 g</b></li> <li>• inkl. Befestigungsschrauben</li> <li>• auf M-Wave Eurolochkarte</li> </ul>	<b>BOTTLE CAGE ›BC 33‹</b> <ul style="list-style-type: none"> <li>• <b>high quality</b>, black <b>nylon</b></li> <li>• bottle can be easily taken out from right- and left-handers</li> <li>• <b>flexible</b> and universal adaptation to different bottle forms</li> <li>• <b>outward chamfered edges</b> make <b>placing and removing</b> of the bottle easier</li> <li>• only <b>33 g</b></li> <li>• incl. fixing screws</li> <li>• on M-Wave eurohole card</li> </ul> <p style="text-align: right;">UVP 4,90 €</p>	

ART.-NR.	BESCHREIBUNG	DESCRIPTION	
<p><b>340051</b></p> <p><b>340053</b> 100</p>	<p><b>FLASCHENHALTER</b></p> <ul style="list-style-type: none"> <li>• besonders geeignet für <b>E-Bike Rahmengeometrien</b> mit eingeschränktem Platz</li> <li>• nach außen gebogene Ränder <b>erleichtern</b> das Einführen der Flasche</li> <li>• mit Befestigungsschrauben</li> <li>• auf M-Wave Eurolochkarte</li> </ul> <p><b>›BC 29 Side:</b></p> <ul style="list-style-type: none"> <li>• Flasche kann <b>auch von der Seite</b> leicht eingeführt und entnommen werden</li> <li>• nur 29 g</li> </ul> <p><b>›BC 26 Side:</b></p> <ul style="list-style-type: none"> <li>• Flasche kann auch <b>schräg von der Seite</b> leicht eingeführt und entnommen werden</li> <li>• nur 26 g</li> </ul>	<p><b>BOTTLE CAGE</b></p> <ul style="list-style-type: none"> <li>• especially suitable for <b>e-bike frame geometries</b> with limited space</li> <li>• outward chamfered edges <b>make it easier</b> to put in the bottle</li> <li>• with mounting screws</li> <li>• on M-Wave eurohole card</li> </ul> <p><b>›BC 29 Side:</b></p> <ul style="list-style-type: none"> <li>• bottle can be easily put in and taken away, also <b>from the side</b></li> <li>• only 29 g</li> </ul> <p><b>›BC 26 Side:</b></p> <ul style="list-style-type: none"> <li>• bottle can be easily put in and taken away, also <b>diagonal from the side</b></li> <li>• only 26 g</li> </ul>	         <p>UVP 3,90 €</p>
<p><b>340991</b></p> <p><b>340989</b> 100</p>	<p><b>FLASCHENHALTER</b></p> <ul style="list-style-type: none"> <li>• Aluminium</li> <li>• nur <b>49 g</b></li> <li>• Flasche kann <b>auch von vorne leicht eingeführt</b> und <b>entnommen</b> werden</li> <li>• leicht nach außen gebogene Ränder <b>erleichtern das Einführen</b> der Flasche</li> <li>• inkl. Befestigungsschrauben</li> <li>• Montageverpackung</li> </ul> <p>mattschwarz eloxiert</p> <p>weiß</p>	<p><b>BOTTLE CAGE</b></p> <ul style="list-style-type: none"> <li>• aluminium</li> <li>• only <b>49 g</b></li> <li>• bottle can be <b>easily put in</b> and <b>taken away also from the front</b></li> <li>• outward chamfered edges <b>make placing the bottle easier</b></li> <li>• incl. fixing screws</li> <li>• OEM</li> </ul> <p>matt black anodised</p> <p>white</p>	      <p>UVP 5,90 €</p>
<p><b>340884</b></p> <p><b>340889</b> 100/20</p>	<p><b>FLASCHENHALTER ›BC 47 A‹</b></p> <ul style="list-style-type: none"> <li>• Aluminium</li> <li>• nur <b>47 g</b></li> <li>• Flasche kann <b>leicht entnommen</b> werden</li> <li>• <b>leichtes Einführen</b> der Flasche durch leicht nach außen gebogene Ränder</li> <li>• inkl. Befestigungsschrauben</li> <li>• auf M-Wave Eurolochkarte</li> </ul> <p>schwarz</p> <p>silber</p>	<p><b>BOTTLE CAGE ›BC 47 A‹</b></p> <ul style="list-style-type: none"> <li>• aluminium</li> <li>• only <b>47 g</b></li> <li>• bottle can be <b>easily taken away</b></li> <li>• outward chamfered edges <b>make placing the bottle easier</b></li> <li>• incl. fixing screws</li> <li>• on M-Wave eurohole card</li> </ul> <p>black</p> <p>silver</p>	       <p>UVP 5,90 €</p>

ART.-NR. 	BESCHREIBUNG	DESCRIPTION	
<p><b>NICE PRICE</b></p> <p><b>340965</b> schwarz</p> <p><b>340966</b> silber 200</p>	<p><b>FLASCHENHALTER ›BC 54 A‹</b></p> <ul style="list-style-type: none"> <li>• mit <b>Knopf</b> für <b>besseren Halt</b> und <b>Schutz</b> der Flasche</li> <li>• nur 54 g</li> <li>• inkl. Befestigungsschrauben</li> <li>• auf M-Wave Eurolochkarte</li> </ul>	<p><b>BOTTLE CAGE ›BC 54 A‹</b></p> <ul style="list-style-type: none"> <li>• with <b>knob</b> for <b>better fixation</b> and <b>protection</b> of the bottle</li> <li>• only 54 g</li> <li>• incl. fixing screws</li> <li>• on M-Wave eurohole card</li> </ul> <p>UVP 4,90 €</p>	
<p><b>340018</b> 100</p>	<p><b>FLASCHENHALTER ›BC 45‹</b></p> <ul style="list-style-type: none"> <li>• <b>Aluminium</b> und hochwertiger Kunststoff</li> <li>• nur 45 g</li> <li>• guter Halt der Flasche durch <b>flexibles Rückenteil</b></li> <li>• mit Befestigungsschrauben</li> <li>• auf M-Wave Eurolochkarte</li> </ul>	<p><b>BOTTLE CAGE ›BC 45‹</b></p> <ul style="list-style-type: none"> <li>• <b>aluminium</b> and high quality plastic</li> <li>• only 45 g</li> <li>• good hold of the bottle due to <b>flexible back part</b></li> <li>• with mounting screws</li> <li>• on M-Wave eurohole card</li> </ul> <p>UVP 3,90 €</p>	
<p><b>340938</b> schwarz</p> <p><b>340939</b> silber 100</p>	<p><b>FLASCHENHALTER</b></p> <ul style="list-style-type: none"> <li>• Aluminium</li> <li>• mit <b>Knopf</b> für <b>besseren Halt</b> und <b>Schutz</b> der Flasche</li> <li>• 6 mm</li> <li>• Montageverpackung</li> </ul>	<p><b>BOTTLE CAGE</b></p> <ul style="list-style-type: none"> <li>• aluminium</li> <li>• with <b>knob</b> for <b>better fixation</b> and <b>protection</b> of the bottle</li> <li>• 6 mm</li> <li>• OEM</li> </ul> <p>UVP 3,90 €</p>	
<ul style="list-style-type: none"> <li>• <b>340883</b> schwarz</li> <li>• <b>340882</b> silber</li> <li>• <b>340842</b> weiß</li> <li>• <b>340843</b> rot</li> <li>• <b>340844</b> blau</li> <li>• <b>340845</b> grün</li> <li>• <b>340847</b> orange/gold</li> <li>• <b>340848</b> pink 100</li> </ul>	<p><b>FLASCHENHALTER</b></p> <ul style="list-style-type: none"> <li>• Aluminium</li> <li>• 6 mm</li> <li>• Montageverpackung</li> </ul>	<p><b>BOTTLE CAGE</b></p> <ul style="list-style-type: none"> <li>• aluminium</li> <li>• 6 mm</li> <li>• OEM</li> </ul> <p>UVP 3,90 €</p>	



ART.-NR.	BESCHREIBUNG	DESCRIPTION	
<b>340896</b> 100/5	<b>FLASCHENHALTER</b> <ul style="list-style-type: none"> <li>• 5 mm <b>Aluminium</b></li> <li>• flexibler Befestigungsabstand</li> <li>• inkl. Befestigungsschrauben</li> <li>• Montageverpackung</li> </ul>	<b>BOTTLE CAGE</b> <ul style="list-style-type: none"> <li>• 5 mm <b>aluminium</b></li> <li>• flexible fixing distance</li> <li>• incl. fixing screws</li> <li>• OEM</li> </ul>	
<b>340927</b> 240	<b>FLASCHENHALTER ›BC PET 500 A‹</b> <ul style="list-style-type: none"> <li>• nur <b>31 g</b></li> <li>• passend auch für (PET)-Flaschen mit <b>500 ml</b> Volumen</li> <li>• Durchmesser 64 - 66 mm</li> <li>• schwarz</li> <li>• auf M-Wave Eurolochkarte</li> </ul>	<b>BOTTLE CAGE ›BC PET 500 A‹</b> <ul style="list-style-type: none"> <li>• only <b>31 g</b></li> <li>• also suitable for (PET) bottles with <b>500 ml</b> volume</li> <li>• diameter 64 - 66 mm</li> <li>• black</li> <li>• on M-Wave eurohole card</li> </ul>	
<b>340725</b> 100  <b>340726</b> 200	<b>FLASCHENHALTER ›BC 32 FLEX‹</b> <ul style="list-style-type: none"> <li>• hochwertiger Kunststoff</li> <li>• sehr <b>flexibel</b>, passt sich Flaschen von <b>0,33 l - 1,5 l</b> Volumen an</li> <li>• nur <b>32 g</b></li> </ul> auf M-Wave Eurolochkarte	<b>BOTTLE CAGE ›BC 32 FLEX‹</b> <ul style="list-style-type: none"> <li>• high quality plastic</li> <li>• very <b>flexible</b>, suitable for bottles with <b>0.33 l up to 1.5 l</b> volume</li> <li>• only <b>32 g</b></li> </ul> on M-Wave eurohole card  OEM	<b>0,33L - 1,5 L</b> <b>XS-XL</b> 
<b>340920</b> 100	<b>FLASCHENHALTER</b> <ul style="list-style-type: none"> <li>• <b>Länge individuell verstellbar</b></li> <li>• passend auch für (PET)-Flaschen mit bis zu <b>1,5 l</b> Volumen</li> <li>• Durchmesser 88 mm</li> <li>• mit zusätzlichem <b>Sicherungshaltegummi</b></li> <li>• Montageverpackung</li> </ul>	<b>BOTTLE CAGE</b> <ul style="list-style-type: none"> <li>• <b>length individually adjustable</b></li> <li>• also suitable for (PET) bottles with up to <b>1.5 l</b> volume</li> <li>• diameter 88 mm</li> <li>• with additional <b>safety rubber</b></li> <li>• OEM</li> </ul>	

ART.-NR.	BESCHREIBUNG	DESCRIPTION	
<p><b>340950</b> 40</p> <p><b>340951</b> 50</p>	<p><b>FLASCHENHALTER ›BC 360°‹</b></p> <ul style="list-style-type: none"> <li>hochwertiger, schwarzer Kunststoff</li> <li>mit <b>drehbarer Schelle</b>, werkzeuglose Montage am Rahmen, Lenkerbügel, ... mit <b>Schnellspanner</b> möglich (ca. Ø 16 - 32 mm)</li> <li>auch passend für die meisten 0,7 - 1,0 Liter Flaschen</li> </ul> <p>auf M-Wave Eurolochkarte</p> <p>Modell ›Eco‹</p> <ul style="list-style-type: none"> <li>im Polybeutel, ohne Logo</li> </ul>	<p><b>BOTTLE CAGE ›BC 360°‹</b></p> <ul style="list-style-type: none"> <li>high grade, black plastic</li> <li>with <b>turnable clamp</b>, toolless mounting at the frame, handlebar, ... with <b>QR</b> (approx. Ø 16 - 32 mm)</li> <li>also suitable for the most 0.7 - 1.0 litre bottles</li> </ul> <p>on M-Wave eurohole card</p> <p>model ›Eco‹</p> <ul style="list-style-type: none"> <li>in PE bag, w/o logo</li> </ul> <p>UVP 6,90 €</p>	     
<p><b>340793</b> 100</p> <p><b>NEW</b></p>	<p><b>FLASCHENHALTER</b></p> <ul style="list-style-type: none"> <li>Kunststoff</li> <li>nur 29 g</li> <li>Montageverpackung</li> </ul>	<p><b>BOTTLE CAGE</b></p> <ul style="list-style-type: none"> <li>plastic</li> <li>only 29 g</li> <li>OEM</li> </ul> <p>UVP 2,90 €</p>	 <p>29 g</p> 
<p><b>340150</b> 100</p>	<p><b>BECHERHALTER ›TO GO‹</b></p> <ul style="list-style-type: none"> <li><b>universell</b> passend für handelsübliche <b>Trinkflaschen, Kaffeebecher</b>, ...</li> <li>mit Anti-Rutsch-Einlage</li> <li>mit Befestigungsklemme für Ø 22,2 - 25,4 mm</li> <li>aus Aluminium</li> <li>auf M-Wave Eurolochkarte</li> </ul>	<p><b>CUPHOLDER ›TO GO‹</b></p> <ul style="list-style-type: none"> <li><b>universally</b> suitable for customary <b>bottles, coffee mugs</b>, ...</li> <li>with non slip insole</li> <li>with fastening clamp for Ø 22.2 - 25.4 mm</li> <li>made of aluminium</li> <li>on M-Wave eurohole card</li> </ul> <p>UVP 4,90 €</p>	    
<p><b>340152</b> 250</p>	<p><b>FLASCHENHALTER</b></p> <ul style="list-style-type: none"> <li><b>universell</b> passend für handelsübliche <b>Trinkflaschen, Kaffeebecher</b>, ...</li> <li>aus hochwertigem Kunststoff</li> <li>nur 24 g</li> <li>für Lenker, ...</li> <li>Befestigungsklemme Ø 22,2 - 25,4 mm</li> <li>auf Ventura Eurolochkarte</li> </ul>	<p><b>BOTTLE CAGE</b></p> <ul style="list-style-type: none"> <li><b>universally</b> suitable for customary <b>bottles, coffee mugs</b>, ...</li> <li>made of high quality plastic</li> <li>only 24 g</li> <li>for handlebar, ...</li> <li>mounting clamp Ø 22.2 - 25.4 mm</li> <li>on Ventura eurohole card</li> </ul> <p>UVP 2,90 €</p>	    

ART.-NR.	BESCHREIBUNG	DESCRIPTION	
<b>NEW</b>  <b>245025</b> 400  <b>245026</b> 200	<b>HALTER FÜR AIRTAG</b> <b>›AIRCASE BC‹</b>  <ul style="list-style-type: none"> <li>ermöglicht die <b>unauffällige Anbringung des Apple AirTag Senders unter dem Flaschenhalter</b></li> <li>inkl. längerer Schrauben</li> </ul>	<b>BRACKET FOR AIRTAG</b> <b>›AIRCASE BC‹</b>  <ul style="list-style-type: none"> <li>enables the <b>Apple AirTag transmitter to be unobtrusively attached under the bottle holder</b></li> <li>incl. extra long screws</li> </ul>	
<b>340041</b> 100 set	<b>FLASCHENHALTER-ADAPTER</b> <b>›ADA BC FLEX 2‹</b>  <ul style="list-style-type: none"> <li>zur universellen Montage eines Flaschenhalters an unterschiedlichen Stellen, bei <b>verschiedensten Rahmengeometrien</b> oder bei eingeschränktem Platz an E-Bikes</li> <li>schnelle und flexible <b>Montagemöglichkeiten durch</b> non-slip Klettbänder (Art. 340042)</li> <li>1 Set = 1 Paar Adapter, 1 Paar Klett-bänder</li> <li>auf M-Wave Eurolochkarte</li> </ul>	<b>BOTTLE CAGE ADAPTER</b> <b>›ADA BC FLEX 2‹</b>  <ul style="list-style-type: none"> <li>for universal mounting of a bottle cage at different places, at <b>most different frame geometries</b> or for e-bikes with little space for bottle cage mounting</li> <li>fast and flexible <b>mounting possibilities</b> by non-slip hook and loop fasteners (art. 340042)</li> <li>1 set = 1 pair of adapters, 1 pair of hook and loop fasteners</li> <li>on M-Wave eurohole card</li> </ul>	
<b>340042</b> 3.000	<b>UNIVERSALBEFESTIGUNGS-BAND</b>  <ul style="list-style-type: none"> <li>Klettband</li> <li>mit <b>Silikon-Antirutsch-Streifen</b></li> <li>Länge: 25 cm, Breite: 2 cm</li> <li>Montageverpackung</li> </ul>	<b>UNIVERSAL MOUNTING TAPE</b>  <ul style="list-style-type: none"> <li>hook and loop fastener</li> <li>with <b>silicone non-slip stripes</b></li> <li>length: 25 cm, width: 2 cm</li> <li>OEM</li> </ul>	
<b>340013</b> 100 Set	<b>FLASCHENHALTER-ADAPTER</b> <b>›ADA SLIDE‹</b>  <ul style="list-style-type: none"> <li>zur optimalen Montage eines Flaschenhalters bei <b>verschiedensten Rahmengeometrien</b> oder bei eingeschränktem Platz an E-Bikes</li> <li><b>90 mm (+/- 45 mm) Verstellbereich</b> in der Höhe</li> <li>aus Aluminium</li> <li>inkl. Befestigungsmaterial</li> <li>in M-Wave Eurolochbox</li> </ul>	<b>BOTTLE CAGE ADAPTER</b> <b>›ADA SLIDE‹</b>  <ul style="list-style-type: none"> <li>for optimal mounting of a bottle cage at <b>most different frame geometries</b> or for e-bikes with little space for bottle cage mounting</li> <li><b>90 mm (+/- 45 mm) height adjustment range</b></li> <li>made of aluminium</li> <li>incl. fixing material</li> <li>in M-Wave eurohole box</li> </ul>	
<b>340015</b> 250 Set	<b>FLASCHENHALTER-ADAPTER</b> <b>›ADA TWO‹</b>  <ul style="list-style-type: none"> <li>zur Befestigung von <b>2 Flaschenhaltern</b> an einer Flaschenhalteraufnahme</li> <li><b>seitliche Befestigung</b> von Flaschenhaltern möglich, auch bei Rahmengeometrien mit <b>Platzproblemen</b></li> <li>aus <b>Aluminium</b></li> <li>nur <b>9 g</b></li> <li>inkl. Befestigungsmaterial</li> <li>auf M-Wave Eurolochkarte</li> </ul>	<b>BOTTLE CAGE ADAPTER</b> <b>›ADA TWO‹</b>  <ul style="list-style-type: none"> <li>for assembling of <b>2 bottle cages</b> at one bottle cage eyelet</li> <li>bottle cages can be <b>sloped to the sides</b>, also for frame geometries that leave <b>little space</b> for bottle cages</li> <li>made of <b>aluminium</b></li> <li>only <b>9 g</b></li> <li>incl. fixing material</li> <li>on M-Wave eurohole card</li> </ul>	





ART.-NR. 	BESCHREIBUNG	DESCRIPTION	
<b>340046</b> 100 <b>NEW</b>	<b>FLASCHENHALTER ADAPTER ›ADA S III‹</b> <ul style="list-style-type: none"> <li>zur Montage von zwei <b>Flaschenhaltern am Sattelgestell</b></li> <li>zusätzliche <b>Stabilisierung großer Satteltaschen</b>, z. B. Art. 122630/6</li> <li>Aluminium</li> <li>stabile Klemmbefestigung</li> <li>auf M-Wave Eurolochkarte</li> </ul>	<b>BOTTLE CAGE ADAPTER ›ADA S III‹</b> <ul style="list-style-type: none"> <li>for mounting of two <b>bottle cages at the saddle rails</b></li> <li>additional <b>stabilization of big saddle bags</b>, e. g. art. 122630/6</li> <li>aluminium</li> <li>stable clamp attachment</li> <li>on M-Wave eurohole card</li> </ul>	   
<b>340019</b> 200 set	<b>FLASCHENHALTER-ADAPTER ›ADA FLEX‹</b> <ul style="list-style-type: none"> <li>zur Montage von <b>Flaschenhaltern an beliebigen Rohren</b> (z. B. Vorbau, Sitzrohr, Sattelstütze, Lenker, ...)</li> <li>mit <b>3 Nirosta-Halteschellen</b> für 19 - 22,4 mm, 22,4 - 27 mm und 28,6 - 31,8 mm Rohrdurchmesser</li> <li>mit <b>werkzeuglos abnehmbarem Halter</b></li> <li>passend für <b>alle gängigen Flaschenhalter</b></li> <li>auf M-Wave Eurolochkarte</li> </ul>	<b>BOTTLE CAGE ADAPTER ›ADA FLEX‹</b> <ul style="list-style-type: none"> <li>for assembling a <b>bottle cage at any tubes</b> (e. g. stem, seat tube, seat post, handlebar, ...)</li> <li>with <b>3 stainless steel clamps</b> for tube diameter 19 - 22.4 mm, 22.4 - 27 mm und 28.6 - 31.8 mm</li> <li>with <b>toolless disassembling bracket</b></li> <li>usable for <b>all current bottle cages</b></li> <li>on M-Wave eurohole card</li> </ul>	 
<b>340017</b> 100	<b>FLASCHENHALTER-ADAPTER ›ADA T90‹</b> <ul style="list-style-type: none"> <li>zur Montage eines <b>Flaschenhalters am Lenker</b>, Sattelstütze, ...</li> <li>Aluminium</li> <li>für Lenkerdurchmesser 22,2 - 25,4 mm</li> <li>inkl. Edelstahlbefestigungsschrauben</li> <li>auf M-Wave Eurolochkarte</li> </ul>	<b>BOTTLE CAGE ADAPTER ›ADA T90‹</b> <ul style="list-style-type: none"> <li>for mounting of a <b>bottle cage at the handlebar</b>, seat post, ...</li> <li>aluminium</li> <li>for handlebar diameter 22.2 - 25.4 mm</li> <li>incl. stainless steel fixing screws</li> <li>on M-Wave eurohole card</li> </ul>	 
<b>122830</b> 100	<b>FLASCHENHALTER-TASCHE ›GRONINGEN BC‹</b> <ul style="list-style-type: none"> <li>inkl. Aluminium-Adapter zur Befestigung an den Flaschenhalterösen (unter dem Flaschenhalter)</li> <li><b>wasserdicht</b></li> <li>mit Innentasche für z. B. Kettenverschlussglieder, ...</li> <li>Tasche kann leicht (de-)montiert werden</li> <li>Adapter kann auch nur mit Klettbindern (z. B. Art. 340042) genutzt werden</li> <li>Größe: ca. 11,0 x 7,5 x 6,5 cm (L x B x H)</li> <li>auf M-Wave Eurolochkarte</li> </ul>	<b>BOTTLE CAGE BAG ›GRONINGEN BC‹</b> <ul style="list-style-type: none"> <li>incl. aluminium adapter for mounting to the bottle cage eyelets (below the bottle cage)</li> <li><b>waterproof</b></li> <li>with inner bag for e. g. chain links, ...</li> <li>bag can easily be (de-)mounted</li> <li>bracket can also be used only with hook and loop straps (e. g. art. 340042)</li> <li>size: approx. 11.0 x 7.5 x 6.5 cm (L x B x H)</li> <li>on M-Wave eurohole card</li> </ul>	 
<b>340014</b> 1.400 set	<b>BEFESTIGUNGS-SET</b> <ul style="list-style-type: none"> <li>für Trinkflaschenhalter</li> <li>je 2 Schellen, Schrauben und Muttern</li> <li>1 Set im Polybeutel</li> </ul>	<b>FITTING SET</b> <ul style="list-style-type: none"> <li>for water bottle cage</li> <li>each 2 clamps, screws and nuts</li> <li>1 set in PE bag</li> </ul>	





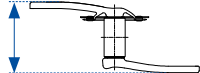



# CHAINWHEEL SETS AND BOTTOM BRACKETS



# RENNRAD-KETTENRADGARNITUREN ROAD CHAINWHEEL SETS

ART.-NR.	BESCHREIBUNG	DESCRIPTION	Q-FAKTOR 
ROAD <span style="float: right;">ROAD</span>			
<p><b>351005</b> AD 10</p> <p><b>NEW</b></p>	<p><b>KOMPAKT KETTENRAD-GARNITUR</b></p> <ul style="list-style-type: none"> <li>• 34/50 Zähne</li> <li>• geschmiedete Aluminiumkurbel</li> <li>• Kurbellänge: 172,5 mm</li> <li>• Q-Faktor: 153 mm</li> <li>• <b>CrMo</b>-Hohlachse</li> <li>• nur <b>1.100 g</b></li> <li>• <b>CNC-gefräste Aluminiumkettenblätter</b></li> <li>• Kettenblätter auswechselbar</li> <li>• Lochkreis: 110 mm</li> <li>• Kettenlinie: 43,5 mm</li> <li>• passendes Innenlager Art. 359430</li> <li>• Montageverpackung</li> </ul>	<p><b>COMPACT CHAINWHEEL SET</b></p> <ul style="list-style-type: none"> <li>• 34/50 teeth</li> <li>• forged aluminium crank</li> <li>• crank length: 172.5 mm</li> <li>• Q-factor: 153 mm</li> <li>• <b>CrMo</b> hollow axle</li> <li>• only <b>1,100 g</b></li> <li>• <b>CNC machined aluminium chainrings</b></li> <li>• replaceable chainrings</li> <li>• bolt circle: 110 mm</li> <li>• chain line: 43.5 mm</li> <li>• suitable bottom bracket art. 359430</li> <li>• OEM</li> </ul> <p style="text-align: right;">UVP 69,90 € UVP mAD 101,90 €</p>	<p>Tested by the manufacturer based on ISO 4210</p> <p style="text-align: right;"><b>11</b> Speed</p> 
<p><b>351001</b> AD 10 set</p>	<p><b>KOMPAKT KETTENRAD-GARNITUR</b></p> <ul style="list-style-type: none"> <li>• 34/50 Zähne</li> <li>• kaltgeschmiedete Aluminiumkurbel</li> <li>• Kurbellänge: 172,5 mm</li> <li>• Q-Faktor: 158 mm</li> <li>• <b>CrMo</b>-Hohlachse</li> <li>• nur 837 g</li> <li>• <b>CNC-gefräste Aluminiumkettenblätter</b></li> <li>• Kettenblätter auswechselbar</li> <li>• Lochkreis: 110 mm</li> <li>• Kettenlinie: 43,5 mm</li> <li>• passendes Innenlager Art. 359310</li> <li>• Montageverpackung</li> </ul>	<p><b>COMPACT CHAINWHEEL SET</b></p> <ul style="list-style-type: none"> <li>• 34/50 teeth</li> <li>• cold forged aluminium crank</li> <li>• crank length: 172.5 mm</li> <li>• Q-factor: 158 mm</li> <li>• <b>CrMo</b> hollow axle</li> <li>• only 837 g</li> <li>• <b>CNC machined aluminium chainrings</b></li> <li>• replaceable chainrings</li> <li>• bolt circle: 110 mm</li> <li>• chain line: 43.5 mm</li> <li>• suitable bottom bracket art. 359310</li> <li>• OEM</li> </ul> <p style="text-align: right;">UVP 77,90 € UVP mAD 113,90 €</p>	<p>Tested by the manufacturer based on ISO 4210</p> <p style="text-align: right;"><b>10</b> Speed</p>  <p style="text-align: center;"><b>CNC ALUMINIUM</b></p>
<p><b>351002</b> AD 10 set</p>	<p><b>KOMPAKT KETTENRAD-GARNITUR</b></p> <ul style="list-style-type: none"> <li>• 34/50 Zähne</li> <li>• Aluminiumkurbel</li> <li>• Kurbellänge: 172,5 mm</li> <li>• JIS</li> <li>• <b>CNC-gefrästes Aluminiumkettenblatt (50 Zähne)</b></li> <li>• <b>Aluminiumkettenblätter auswechselbar</b></li> <li>• Lochkreis: 110 mm</li> <li>• für Vierkant-Innenlager</li> <li>• Innenlagerlänge: 110,5 mm</li> <li>• Gewicht <b>nur 659 g</b></li> <li>• Montageverpackung</li> </ul>	<p><b>COMPACT CHAINWHEEL SET</b></p> <ul style="list-style-type: none"> <li>• 34/50 teeth</li> <li>• aluminium crank</li> <li>• crank length: 172.5 mm</li> <li>• JIS</li> <li>• <b>CNC machined aluminium chainring (50 teeth)</b></li> <li>• <b>replaceable aluminium chainrings</b></li> <li>• bolt circle: 110 mm</li> <li>• for square link bottom bracket</li> <li>• B.B. set length: 110.5 mm</li> <li>• weight <b>only 659 g</b></li> <li>• OEM</li> </ul> <p style="text-align: right;">UVP 54,90 € UVP mAD 79,90 €</p>	<p>Tested by the manufacturer based on ISO 4210</p> <p style="text-align: right;"> <b>659 g</b></p> 
<p><b>351007</b> AD</p> <p><b>351008</b> AD 10 set</p>	<p><b>KETTENRADGARNITUR</b></p> <ul style="list-style-type: none"> <li>• <b>Aluminium/Stahl</b></li> <li>• Kurbellänge: 170 mm</li> <li>• JIS</li> <li>• <b>Kettenblätter auswechselbar</b></li> <li>• Lochkreis: 110 mm</li> <li>• für Vierkant-Innenlager</li> <li>• Innenlagerlänge: 113,5 mm (47,5 mm = Mitte Innenlager bis Innenkante kleines Kettenblatt)</li> <li>• Montageverpackung</li> </ul> <p>34/50 Zähne (kompakt)</p> <p>42/52 Zähne</p>	<p><b>CHAINWHEEL SET</b></p> <ul style="list-style-type: none"> <li>• <b>aluminium/steel</b></li> <li>• crank length: 170 mm</li> <li>• JIS</li> <li>• <b>replaceable chainrings</b></li> <li>• bolt circle: 110 mm</li> <li>• for square link bottom bracket</li> <li>• B.B. set length: 113.5 mm (47.5 mm = center B.B.-Set till inner edge of small chainring)</li> <li>• OEM</li> </ul> <p>34/50 teeth (compact)</p> <p>42/52 teeth</p> <p style="text-align: right;">UVP 32,90 € UVP mAD 47,90 €</p>	<p>Tested by the manufacturer based on ISO 4210</p> <p style="text-align: right;"><b>9</b> Speed</p> 

# ROAD/MTB KETTENRADGARNITUREN ROAD/MTB CHAINWHEEL SETS

ART.-NR.	BESCHREIBUNG	DESCRIPTION	
<b>351009</b> AD 10 set	<b>KETTENRADGARNITUR</b> <ul style="list-style-type: none"> <li>• 30/42/52 Zähne</li> <li>• <b>polierte, kaltgeschmiedete Aluminiumkurbel</b></li> <li>• Kurbellänge: 170 mm</li> <li>• JIS</li> <li>• silberne Stahlkettenblätter, <b>auswechselbar</b></li> <li>• Lochkreis: 74 mm (30 Z.)/110 mm (42/52 Z.)</li> <li>• Innenlagerlänge: 113 mm</li> <li>• Montageverpackung</li> </ul>	<b>CHAINWHEEL SET</b> <ul style="list-style-type: none"> <li>• 30/42/52 teeth</li> <li>• <b>polished, cold forged aluminium crank</b></li> <li>• crank length: 170 mm</li> <li>• JIS</li> <li>• silver steel chainrings, <b>replaceable</b></li> <li>• bolt circle: 74 mm (30 t.) /110 mm (42/52 t.)</li> <li>• B.B. set length: 113 mm</li> <li>• OEM</li> </ul>	  <p style="text-align: right;">UVP 34,90 € UVP mAD 50,90 €</p>
<b>MTB</b>			
<b>351200</b> AD 10 set	<b>KETTENRADGARNITUR</b> <ul style="list-style-type: none"> <li>• 32 Zähne, <b>Narrow wide</b></li> <li>• <b>AL-6061 T6 Aluminiumkurbel</b></li> <li>• Lochkreis: 104 mm</li> <li>• für 11-fach</li> <li>• Kurbellänge: 175 mm</li> <li>• Q-Faktor: 171 mm</li> <li>• <b>CrMo</b>-Hohlachse</li> <li>• Lagerstandard Shimano</li> <li>• Kettenlinie: 50 mm</li> <li>• Montageverpackung</li> </ul>	<b>CHAINWHEEL SET</b> <ul style="list-style-type: none"> <li>• 32 teeth, <b>narrow wide</b></li> <li>• <b>AL-6061 T6 aluminium crank</b></li> <li>• bolt circle: 104 mm</li> <li>• for 11 speed</li> <li>• crank length: 175 mm</li> <li>• Q-factor: 171 mm</li> <li>• <b>CrMo</b> hollow axle</li> <li>• bottom bracket standard Shimano</li> <li>• chain line: 50 mm</li> <li>• OEM</li> </ul>	<p>Tested by the manufacturer based on ISO 4210</p>   <p style="text-align: right;">UVP 89,90 € UVP mAD 130,90 €</p>
<b>351201</b> AD 10 set	<b>KETTENRADGARNITUR BOOST</b> <ul style="list-style-type: none"> <li>• 32 Zähne, <b>Narrow wide</b></li> <li>• <b>AL-6061 T6 Aluminiumkurbel</b></li> <li>• für <b>Boost 148</b> Standard</li> <li>• <b>AL-7075 T6 Aluminiumkettenblatt</b></li> <li>• Sram Vielzahn-Aufnahme kompatibel</li> <li>• für <b>11-fach</b></li> <li>• Kurbellänge: 175 mm</li> <li>• Q-Faktor: 171 mm</li> <li>• <b>CrMo</b>-Hohlachse</li> <li>• Lagerstandard Shimano</li> <li>• Kettenlinie 52 mm</li> <li>• Montageverpackung</li> </ul>	<b>CHAINWHEEL SET BOOST</b> <ul style="list-style-type: none"> <li>• 32 teeth, <b>narrow wide</b></li> <li>• <b>AL-6061 T6 aluminium crank</b></li> <li>• for <b>boost 148</b> standard</li> <li>• <b>AL-7075 T6 aluminium chainring</b></li> <li>• Sram multi-tooth type compatible</li> <li>• for <b>11 speed</b></li> <li>• crank length: 175 mm</li> <li>• Q-factor: 171 mm</li> <li>• <b>CrMo</b> hollow axle</li> <li>• bottom bracket standard Shimano</li> <li>• chain line 52 mm</li> <li>• OEM</li> </ul>	<p>Tested by the manufacturer based on ISO 4210</p>  <p style="text-align: right;">UVP 83,90 € UVP mAD 121,90 €</p>
<b>350624</b>  <b>350625</b>  <b>350626</b> 10	<b>Umrüst-/Ersatzkettenblatt</b> <ul style="list-style-type: none"> <li>• <b>AL-7075 Aluminium</b></li> <li>• für 351201, ...</li> <li>• Montageverpackung</li> </ul> <p>zur Umrüstung auf <b>boost</b> Ausführung, <b>Narrow wide</b></p>	<b>conversion /replaceable chain ring</b> <ul style="list-style-type: none"> <li>• <b>AL-7075 aluminium</b></li> <li>• für 351201, ...</li> <li>• OEM</li> </ul> <p>for conversion to <b>boost</b> type, <b>narrow wide</b></p>	 <p style="text-align: right;">UVP 55,90 €</p>

# MTB/TREKKING KETTENRADGARNITUREN

## MTB/TREKKING CHAINWHEEL SETS

ART.-NR.	BESCHREIBUNG	DESCRIPTION	
<b>MTB/TREKKING</b>			
<b>351202</b> AD 10 set	<b>KETTENRADGARNITUR</b> <ul style="list-style-type: none"> <li>• 26/36 Zähne</li> <li>• <b>geschmiedete AL-6061 T6 Aluminium-kurbel</b></li> <li>• <b>CNC-gefrästes AL-7075 T6 Aluminiumkettenblatt (36 Z.)</b></li> <li>• Lochkreis: 64 mm (26 Z.), 104 mm (36 Z.)</li> <li>• für 11-fach</li> <li>• Kurbellänge: 175 mm</li> <li>• Q-Faktor: 176 mm</li> <li>• <b>CrMo</b>-Hohlachse</li> <li>• Kettenlinie 49 mm</li> <li>• passendes Innenlager Art. 359311</li> <li>• Montageverpackung</li> </ul>	<b>CHAINWHEEL SET</b> <ul style="list-style-type: none"> <li>• 26/36 teeth</li> <li>• <b>forged AL-6061 T6 aluminium crank</b></li> <li>• <b>CNC machined AL-7075 T6 aluminium chainring (36 t.)</b></li> <li>• bolt circle: 64 mm (26 t.), 104 mm (36 t.)</li> <li>• for 11 speed</li> <li>• crank length: 175 mm</li> <li>• Q-factor: 176 mm</li> <li>• <b>CrMo</b> hollow axle</li> <li>• chain line 49 mm</li> <li>• suitable bottom bracket art. 359311</li> <li>• OEM</li> </ul>	<div style="border: 1px solid black; padding: 2px; font-size: 8px;">Tested by the manufacturer based on ISO 4210</div> <div style="text-align: right; margin-top: 10px;">  </div> 
<b>351238</b> AD 10 set	<b>KETTENRADGARNITUR</b> <ul style="list-style-type: none"> <li>• 24/38 Zähne</li> <li>• AL-6061 T6 Kurbel</li> <li>• Kurbellänge: 175 mm</li> <li>• Q-Faktor: 176 mm</li> <li>• <b>CrMo</b>-Hohlachse</li> <li>• für 20 Gang</li> <li>• <b>CNC-gefrästes Aluminiumkettenblatt (38 Zähne)</b></li> <li>• Stahl-Kettenblatt 24 Zähne</li> <li>• Lochkreis: 64 mm (24 Z.), 104 mm (38 Z.)</li> <li>• Kettenlinie 49 mm</li> <li>• passendes Innenlager Art. 359430</li> <li>• Montageverpackung</li> </ul>	<b>CHAINWHEEL SET</b> <ul style="list-style-type: none"> <li>• 24/38 teeth</li> <li>• AL-6061 T6 crank</li> <li>• crank length: 175 mm</li> <li>• Q-factor: 176 mm</li> <li>• <b>CrMo</b> hollow axle</li> <li>• for 20 speed</li> <li>• <b>CNC machined aluminium chainring (38 teeth)</b></li> <li>• chainring steel 24 teeth</li> <li>• bolt circle: 64 mm (24 t.), 104 mm (38 t.)</li> <li>• chain line 49 mm</li> <li>• suitable bottom bracket art. 359430</li> <li>• OEM</li> </ul>	<div style="border: 1px solid black; padding: 2px; font-size: 8px;">Tested by the manufacturer based on ISO 4210</div> 
<b>351239</b> AD 10 set	<b>KETTENRADGARNITUR</b> <ul style="list-style-type: none"> <li>• 22/36 Zähne</li> <li>• AL-6061 T6 Kurbel</li> <li>• Kurbellänge: 175 mm</li> <li>• JIS</li> <li>• Q-Faktor: 176/146 mm</li> <li>• für 20 Gang</li> <li>• <b>austauschbare Kettenblätter Stahl (22 Z.)/Aluminium (36 Z.)</b></li> <li>• Lochkreis: 64 mm (22 Z.)/ 104 mm (36 Z.)</li> <li>• Montageverpackung</li> </ul>	<b>CHAINWHEEL SET</b> <ul style="list-style-type: none"> <li>• 22/36 teeth</li> <li>• AL-6061 T6 crank</li> <li>• crank length: 175 mm</li> <li>• JIS</li> <li>• Q-factor: 176/146 mm</li> <li>• for 20 speed</li> <li>• <b>replaceable chainrings steel (22 t.)/aluminium (36 t.)</b></li> <li>• bolt circle: 64 mm (22 t.)/ 104 mm (36 t.)</li> <li>• OEM</li> </ul>	<div style="border: 1px solid black; padding: 2px; font-size: 8px;">Tested by the manufacturer based on ISO 4210</div> <div style="margin-top: 10px;"> <input type="checkbox"/> <b>SQUARE/JIS</b> </div> 
<b>351232</b> AD 10 set	<b>KETTENRADGARNITUR</b> <ul style="list-style-type: none"> <li>• 22/32/44 Zähne</li> <li>• kaltgeschmiedete AL-6061 T6 Kurbel</li> <li>• Q-Faktor: 181 mm</li> <li>• Kurbellänge: 170 mm</li> <li>• <b>CrMo</b>-Hohlachse</li> <li>• für 27 (und 24) Gang</li> <li>• nur 1087 g</li> <li>• 22 (Stahl)/32 (<b>CrMo</b>)/44 (<b>Aluminium, CNC-gefräst</b>) Zähne</li> <li>• Kettenblätter <b>auswechselbar</b></li> <li>• Lochkreis: 64 mm (22 Z.), 104 mm (32/44 Z.)</li> <li>• Kettenlinie: 50 mm</li> <li>• passendes Innenlager Art. 359311</li> <li>• Montageverpackung</li> </ul>	<b>CHAINWHEEL SET</b> <ul style="list-style-type: none"> <li>• 22/32/44 teeth</li> <li>• cold forged AL-6061 T6 crank</li> <li>• Q-factor: 181 mm</li> <li>• crank length: 170 mm</li> <li>• <b>CrMo</b> hollow axle</li> <li>• for 27 (and 24) speed</li> <li>• only 1087 g</li> <li>• 22 (steel)/32 (<b>CrMo</b>)/44 (<b>aluminium, CNC machined</b>) teeth</li> <li>• <b>replaceable</b> chainrings</li> <li>• bolt circle: 64 mm (22 t.), 104 mm (32/44 t.)</li> <li>• chain line: 50 mm</li> <li>• suitable bottom bracket art. 359311</li> <li>• OEM</li> </ul>	<div style="border: 1px solid black; padding: 2px; font-size: 8px;">Tested by the manufacturer based on ISO 4210</div> <div style="text-align: right; margin-top: 10px;">  </div> 

UVP 62,90 €  
UVP mAD 91,90 €

UVP 61,90 €  
UVP mAD 89,90 €

UVP 36,90 €  
UVP mAD 53,90 €







UVP 82,90 €  
UVP mAD 120,90 €



ART.-NR.	BESCHREIBUNG	DESCRIPTION	
<b>351233</b> AD 10 set	<b>KETTENRADGARNITUR</b> <ul style="list-style-type: none"> <li>• 28/38/48 Zähne</li> <li>• <b>kaltgeschmiedete AL-6061 T6 Kurbel</b></li> <li>• Kurbellänge: 170 mm</li> <li>• Q-Faktor: 181 mm</li> <li>• <b>CrMo</b>-Hohlachse</li> <li>• für 27 (und 24) Gang</li> <li>• nur <b>942 g</b></li> <li>• 28/38 (Stahl)/48 (<b>Aluminium, CNC-gefräst</b>) Zähne</li> <li>• Kettenblätter <b>auswechselbar</b></li> <li>• Lochkreis: 64 mm (28 Z.), 104 mm (38/48 Z.)</li> <li>• Kettenlinie: 50 mm</li> <li>• mit <b>Kettenschutz</b></li> <li>• passendes Innenlager Art. 359311</li> <li>• Montageverpackung</li> </ul>	<b>CHAINWHEEL SET</b> <ul style="list-style-type: none"> <li>• 28/38/48 teeth</li> <li>• <b>cold forged AL-6061 T6 crank</b></li> <li>• crank length: 170 mm</li> <li>• Q-factor: 181 mm</li> <li>• <b>CrMo</b> hollow axle</li> <li>• for 27 (and 24) speed</li> <li>• only <b>942 g</b></li> <li>• 28/38 (steel)/48 (<b>aluminium, CNC machined</b>) teeth</li> <li>• <b>replaceable</b> chainrings</li> <li>• bolt circle: 64 mm (28 t.), 104 mm (38/48 t.)</li> <li>• chain line: 50 mm</li> <li>• with <b>chainguard</b></li> <li>• suitable bottom bracket art. 359311</li> <li>• OEM</li> </ul> <p style="text-align: right;">UVP 80,90 € UVP mAD 117,90 €</p>	<div style="border: 1px solid black; padding: 2px; font-size: 8px;">Tested by the manufacturer based on ISO 4210</div> 
<b>INFO</b>	Die angegebene Innenlagerlänge ist gültig für die Verwendung eines BSA-Innenlagers mit einer JIS-Vierkantachse um eine Kettenlinie von 47,5 mm zu erreichen.	Stated B.B. set length is available for using BSA B.B. set with JIS cotterless axle to reach a chain line of 47.5 mm.	
<b>351234</b> AD	<b>KETTENRADGARNITUR</b> <ul style="list-style-type: none"> <li>• 22/32/44 Zähne</li> <li>• für 27 (und 24) Gang</li> <li>• Stahl/Stahl/<b>Aluminium</b>kettenblätter, <b>auswechselbar</b></li> <li>• Lochkreis: 64 mm (22 Z.), 104 mm (32/44 Z.)</li> <li>• JIS</li> <li>• Innenlagerlänge: 119 mm</li> <li>• Montageverpackung</li> </ul>	<b>CHAINWHEEL SET</b> <ul style="list-style-type: none"> <li>• 22/32/44 teeth</li> <li>• for 27 (and 24) speed</li> <li>• steel/steel/<b>aluminium</b> chainrings, <b>replaceable</b></li> <li>• bolt circle: 64 mm (22 t.), 104 mm (32/44 t.)</li> <li>• JIS</li> <li>• B.B. set length: 119 mm</li> <li>• OEM</li> </ul>	<div style="border: 1px solid black; padding: 2px; font-size: 8px;">Tested by the manufacturer based on ISO 4210</div> <div style="text-align: right; font-size: 24px; font-weight: bold; border: 1px solid black; border-radius: 50%; padding: 5px; width: 30px; margin: 0 auto;">9 Speed</div>   <p style="text-align: right;">UVP 37,90 € UVP mAD 55,90 €</p>
<b>351235</b> AD 10 set	<ul style="list-style-type: none"> <li>• <b>schwarze Kurbel</b></li> <li>• Kurbellänge: <b>175 mm</b></li> <li>• schwarzes Kettenblatt, 44 Zähne</li> </ul>	<ul style="list-style-type: none"> <li>• <b>black crank</b></li> <li>• crank length: <b>175 mm</b></li> <li>• black chainring, 44 teeth</li> </ul>	<div style="border: 1px solid black; padding: 2px; font-size: 8px;">Tested by the manufacturer based on ISO 4210</div> <div style="text-align: right; font-size: 24px; font-weight: bold; border: 1px solid black; border-radius: 50%; padding: 5px; width: 30px; margin: 0 auto;">8 Speed</div>   <p style="text-align: right;">UVP 27,00 € UVP mAD 38,90 €</p> <p style="text-align: right;">UVP 27,90 € UVP mAD 39,90 €</p>
<b>351236</b> AD 10 set	ohne Kettenschutz	without chainguard	
<b>351237</b> AD 10 set	mit Kettenschutz	with chainguard	









ART.-NR. 	BESCHREIBUNG	DESCRIPTION	
<b>351240</b> AD 10 set	<b>KETTENRADGARNITUR</b> <ul style="list-style-type: none"> <li>• <b>26/38/48</b> Zähne</li> <li>• für 24 (und 21) Gang</li> <li>• <b>polierte Aluminiumkurbel</b></li> <li>• Kurbellänge: 170 mm</li> <li>• JIS</li> <li>• <b>silberne, auswechselbare</b> Stahlkettenblätter</li> <li>• mit transparentem Kettenschutz</li> <li>• Lochkreis: 64 mm</li> <li>• Innenlagerlänge: 107 mm</li> <li>• Montageverpackung</li> </ul>	<b>CHAINWHEEL SET</b> <ul style="list-style-type: none"> <li>• <b>26/38/48</b> teeth</li> <li>• for 24 (and 21) speed</li> <li>• <b>polished aluminium crank</b></li> <li>• crank length: 170 mm</li> <li>• JIS</li> <li>• <b>silver, replaceable</b> steel chainrings</li> <li>• with transparent chainguard</li> <li>• bolt circle: 64 mm</li> <li>• B.B. set length: 107 mm</li> <li>• OEM</li> </ul> <p style="text-align: right;">UVP 29,90 € UVP mAD 43,90 €</p>	<div style="border: 1px solid black; padding: 2px; font-size: 8px; margin-bottom: 10px;">Tested by the manufacturer based on ISO 4210</div> 
<b>351242</b> AD	<b>KETTENRADGARNITUR</b> <ul style="list-style-type: none"> <li>• <b>Aluminiumkurbel</b></li> <li>• Kurbellänge: 170 mm</li> <li>• JIS</li> <li>• mit Kettenschutz</li> <li>• Innenlagerlänge: 119 mm</li> <li>• Montageverpackung</li> </ul> <p><b>28/38/48</b> Zähne, silber</p> <p><b>22/32/42</b> Zähne</p>	<b>CHAINWHEEL SET</b> <ul style="list-style-type: none"> <li>• <b>aluminium crank</b></li> <li>• crank length: 170 mm</li> <li>• JIS</li> <li>• with chainguard</li> <li>• B.B. set length: 119 mm</li> <li>• OEM</li> </ul> <p><b>28/38/48</b> teeth, silver</p> <p><b>22/32/42</b> teeth</p>	   <p style="text-align: right;">UVP 21,90 € UVP mAD 31,90 €</p>
<b>351243</b> AD	silber	silver	
<b>351249</b> AD 10 set	schwarz	black	
<b>351244</b> AD 10 set	<b>KETTENRADGARNITUR</b> <ul style="list-style-type: none"> <li>• <b>polierte Aluminiumkurbel</b></li> <li>• Kurbellänge: <b>165 mm</b></li> <li>• JIS</li> <li>• 24/34/42 Zähne</li> <li>• silberne Stahlkettenblätter</li> <li>• mit Kettenschutz</li> <li>• Innenlagerlänge: 119 mm</li> <li>• Montageverpackung</li> </ul>	<b>CHAINWHEEL SET</b> <ul style="list-style-type: none"> <li>• <b>polished aluminium crank</b></li> <li>• crank length: <b>165 mm</b></li> <li>• JIS</li> <li>• 24/34/42 teeth</li> <li>• silver steel chainrings</li> <li>• with chainguard</li> <li>• B.B. set length: 119 mm</li> <li>• OEM</li> </ul> <p style="text-align: right;">UVP 20,90 € UVP mAD 30,90 €</p>	
<b>351245</b> AD 10 set	<b>KETTENRADGARNITUR</b> <ul style="list-style-type: none"> <li>• Kurbel kunststoffummantelt</li> <li>• Kurbellänge: 170 mm</li> <li>• JIS</li> <li>• 24/34/42 Zähne</li> <li>• silberne Kettenblätter</li> <li>• mit Kettenschutz</li> <li>• Innenlagerlänge: 119 mm</li> <li>• Montageverpackung</li> </ul>	<b>CHAINWHEEL SET</b> <ul style="list-style-type: none"> <li>• crank plastic coated</li> <li>• crank length: 170 mm</li> <li>• JIS</li> <li>• 24/34/42 teeth</li> <li>• silver chainrings</li> <li>• with chainguard</li> <li>• B.B. set length: 119 mm</li> <li>• OEM</li> </ul> <p style="text-align: right;">UVP 14,90 € UVP mAD 21,90 €</p>	

ART.-NR. 	BESCHREIBUNG	DESCRIPTION	
<p><b>351246</b> AD</p> <p><b>351247</b> AD 10 set</p>	<p><b>KETTENRADGARNITUR</b></p> <ul style="list-style-type: none"> <li>• Kurbel kunststoffummantelt</li> <li>• Kurbellänge: 170 mm</li> <li>• JIS</li> <li>• <b>28/38/48</b> Zähne</li> <li>• mit Kettenschutz</li> <li>• Innenlagerlänge: 119 mm</li> <li>• Montageverpackung</li> </ul> <p>schwarz</p> <p>schwarz/ silber</p>	<p><b>CHAINWHEEL SET</b></p> <ul style="list-style-type: none"> <li>• crank plastic coated</li> <li>• crank length: 170 mm</li> <li>• JIS</li> <li>• <b>28/38/48</b> teeth</li> <li>• with chainguard</li> <li>• B.B. set length: 119 mm</li> <li>• OEM</li> </ul> <p>black</p> <p>black/silver</p> <p>UVP 12,90 € UVP mAD 18,90 €</p>	
<p><b>351248</b> AD 10 set</p>	<p><b>KETTENRADGARNITUR</b></p> <ul style="list-style-type: none"> <li>• Kurbel kunststoffummantelt</li> <li>• Kurbellänge: 170 mm</li> <li>• JIS</li> <li>• <b>24/34/42</b> Zähne</li> <li>• schwarz</li> <li>• mit Kettenschutz</li> <li>• Innenlagerlänge: 119 mm</li> <li>• Montageverpackung</li> </ul>	<p><b>CHAINWHEEL SET</b></p> <ul style="list-style-type: none"> <li>• crank plastic coated</li> <li>• crank length: 170 mm</li> <li>• JIS</li> <li>• <b>24/34/42</b> teeth</li> <li>• black</li> <li>• with chainguard</li> <li>• B.B. set length: 119 mm</li> <li>• OEM</li> </ul> <p>UVP 12,90 € UVP mAD 18,90 €</p>	
<p><b>356193</b> AD 10 set</p>	<p><b>KETTENRADGARNITUR</b></p> <ul style="list-style-type: none"> <li>• <b>Aluminium-Kurbel</b></li> <li>• <b>Aluminiumkettenblatt Narrow Wide</b>, auswechselbar</li> <li>• mit <b>Aluminiumkettenschutz</b></li> <li>• Lochkreis: 104 mm</li> <li>• Kurbellänge: 170 mm</li> <li>• JIS</li> <li>• für 1/2" x 3/32", 1/2" x 11/128" Ketten</li> <li>• für 10/11/12-fach</li> <li>• 40 Zähne</li> <li>• Montageverpackung</li> </ul>	<p><b>CHAINWHEEL SET</b></p> <ul style="list-style-type: none"> <li>• <b>aluminium</b> crank</li> <li>• <b>aluminium</b> chainring <b>narrow wide</b>, changeable</li> <li>• with <b>aluminium chainguard</b></li> <li>• bolt circle: 104 mm</li> <li>• crank length: 170 mm</li> <li>• JIS</li> <li>• for 1/2" x 3/32", 1/2" x 11/128" chains</li> <li>• for 10/11/12 speed</li> <li>• 40 teeth</li> <li>• OEM</li> </ul> <p>UVP 79,90 € UVP mAD 116,90 €</p>	
<p><b>350630</b> AD</p> <p><b>350640</b> AD 10 set</p>	<p><b>KETTENRADGARNITUR</b></p> <ul style="list-style-type: none"> <li>• polierte <b>Aluminiumkurbel</b></li> <li>• schwarzes, <b>austauschbares CNC gefrästes Aluminium</b> Kettenblatt</li> <li>• Lochkreis: 130 mm</li> <li>• Kurbellänge: 165 mm</li> <li>• JIS</li> <li>• 1/2" x 1/8"</li> <li>• Kettenlinie: 45 mm</li> <li>• Innenlagerlänge: 110,5 mm</li> <li>• silber/schwarz</li> <li>• Montageverpackung</li> </ul> <p><b>46 Zähne</b></p> <p><b>44 Zähne</b></p>	<p><b>CHAINWHEEL SET</b></p> <ul style="list-style-type: none"> <li>• polished <b>aluminium</b> crank</li> <li>• black, <b>replacable CNC-machined aluminium</b> chainring</li> <li>• bolt circle: 130 mm</li> <li>• crank length: 165 mm</li> <li>• JIS</li> <li>• 1/2" x 1/8"</li> <li>• chain line: 45 mm</li> <li>• B.B. set length: 110.5 mm</li> <li>• silver/black</li> <li>• OEM</li> </ul> <p><b>46 teeth</b></p> <p><b>44 teeth</b></p> <p>UVP 35,90 € UVP mAD 52,90 €</p>	<p>Tested by the manufacturer based on ISO 4210</p> 

ART.-NR. 	BESCHREIBUNG	DESCRIPTION	
<ul style="list-style-type: none"> <li>• <b>350650</b> AD 10 set</li> <li>• <b>350651</b> AD</li> <li>• <b>350652</b> AD</li> <li>• <b>350653</b> AD 10 set</li> </ul>	<p><b>KETTENRADGARNITUR</b></p> <ul style="list-style-type: none"> <li>• geschmiedete, polierte <b>Aluminiumkurbel</b></li> <li>• Kurbellänge: 170 mm</li> <li>• JIS</li> <li>• silbernes Stahlkettenblatt</li> <li>• 1/2" x 3/32"</li> <li>• Innenlagerlänge: 131 mm</li> <li>• Montageverpackung</li> </ul> <p>46 Zähne</p> <p>44 Zähne</p> <p>38 Zähne</p> <p>33 Zähne</p>	<p><b>CHAINWHEEL SET</b></p> <ul style="list-style-type: none"> <li>• forged, polished <b>aluminium crank</b></li> <li>• crank length: 170 mm</li> <li>• JIS</li> <li>• silver steel chainring</li> <li>• 1/2" x 3/32"</li> <li>• B.B. set length: 131 mm</li> <li>• OEM</li> </ul> <p>46 teeth</p> <p>44 teeth</p> <p>38 teeth</p> <p>33 teeth</p> <p style="text-align: right;">UVP 17,90 € UVP mAD 25,90 €</p>	<p style="border: 1px solid black; padding: 2px; font-size: 8px;">Tested by the manufacturer based on ISO 4210</p> 
<ul style="list-style-type: none"> <li>• <b>350680</b> AD 10 set</li> <li>• <b>350671</b> AD 10 set</li> </ul>	<p><b>KETTENRADGARNITUR</b></p> <ul style="list-style-type: none"> <li>• Kurbellänge: 170 mm</li> <li>• JIS</li> <li>• 38 Zähne</li> <li>• 1/2" x 3/32"</li> <li>• Innenlagerlänge: 127 mm</li> <li>• Montageverpackung</li> </ul> <p><b>Aluminiumkurbel</b></p> <ul style="list-style-type: none"> <li>• schwarz Ersatzkurbel, links = Art. 352671</li> <li>• silber Ersatzkurbel, links = Art. 352672</li> </ul>	<p><b>CHAINWHEEL SET</b></p> <ul style="list-style-type: none"> <li>• crank length: 170 mm</li> <li>• JIS</li> <li>• 38 teeth</li> <li>• 1/2" x 3/32"</li> <li>• B.B. set length: 127 mm</li> <li>• OEM</li> </ul> <p><b>aluminium crank</b></p> <ul style="list-style-type: none"> <li>• black spare crank, left = art. 352671</li> <li>• silver spare crank, left = art. 352672</li> </ul> <p style="text-align: right;">UVP 17,90 € UVP mAD 25,90 €</p>	<p style="border: 1px solid black; padding: 2px; font-size: 8px;">Tested by the manufacturer based on ISO 4210</p> 
<ul style="list-style-type: none"> <li>• <b>352510</b> AD</li> <li>• <b>352511</b> AD 10 set</li> </ul>	<p><b>Kurbel kunststoffummantelt</b></p> <p>schwarz</p> <p>silber</p>	<p><b>crank plastic coated</b></p> <p>black</p> <p>silver</p> <p style="text-align: right;">UVP 9,90 € UVP mAD 14,90 €</p>	
<ul style="list-style-type: none"> <li>• <b>350710</b> AD 20 set</li> </ul>	<p><b>KETTENRADGARNITUR</b></p> <ul style="list-style-type: none"> <li>• <b>für 20" (18" - 24")</b></li> <li>• 1/2" x 3/32"</li> <li>• schwarz</li> <li>• Kurbellänge: <b>152 mm</b>, kunststoffummantelt</li> <li>• JIS</li> <li>• <b>40 Zähne</b></li> <li>• Innenlagerlänge: 119 mm</li> <li>• Montageverpackung</li> </ul>	<p><b>CHAINWHEEL SET</b></p> <ul style="list-style-type: none"> <li>• <b>for 20" (18" - 24")</b></li> <li>• 1/2" x 3/32"</li> <li>• black</li> <li>• crank length: <b>152 mm</b>, plastic coated</li> <li>• JIS</li> <li>• <b>40 teeth</b></li> <li>• B.B. set length: 119 mm</li> <li>• OEM</li> </ul> <p style="text-align: right;">UVP 9,90 € UVP mAD 14,90 €</p>	
<ul style="list-style-type: none"> <li>• <b>350711</b> AD 20 set</li> </ul>	<p><b>KETTENRADGARNITUR</b></p> <ul style="list-style-type: none"> <li>• <b>für 18" (16" - 20")</b></li> <li>• 1/2" x 3/32"</li> <li>• schwarz</li> <li>• Kurbellänge: <b>127 mm</b>, kunststoffummantelt</li> <li>• JIS</li> <li>• <b>36 Zähne</b></li> <li>• Innenlagerlänge: 131 mm</li> <li>• Montageverpackung</li> </ul>	<p><b>CHAINWHEEL SET</b></p> <ul style="list-style-type: none"> <li>• <b>for 18" (16" - 20")</b></li> <li>• 1/2" x 3/32"</li> <li>• black</li> <li>• crank length: <b>127 mm</b>, plastic coated</li> <li>• JIS</li> <li>• <b>36 teeth</b></li> <li>• B.B. set length: 131 mm</li> <li>• OEM</li> </ul> <p style="text-align: right;">UVP 8,90 € UVP mAD 12,90 €</p>	<p style="border: 1px solid black; padding: 2px; font-size: 8px;">Tested by the manufacturer based on ISO 4210</p> 
<ul style="list-style-type: none"> <li>• <b>350712</b> AD 20 set</li> </ul>	<p><b>KETTENRADGARNITUR</b></p> <ul style="list-style-type: none"> <li>• <b>für 16" (12" - 18")</b></li> <li>• 1/2" x 3/32"</li> <li>• schwarz</li> <li>• Kurbellänge: <b>102 mm</b></li> <li>• JIS</li> <li>• <b>32 Zähne</b></li> <li>• Innenlagerlänge: 127 mm</li> <li>• Montageverpackung</li> </ul>	<p><b>CHAINWHEEL SET</b></p> <ul style="list-style-type: none"> <li>• <b>for 16" (12" - 18")</b></li> <li>• 1/2" x 3/32"</li> <li>• black</li> <li>• crank length: <b>102 mm</b></li> <li>• JIS</li> <li>• <b>32 teeth</b></li> <li>• B.B. set length: 127 mm</li> <li>• OEM</li> </ul> <p style="text-align: right;">UVP 7,90 € UVP mAD 11,90 €</p>	



# KETTENRADGARNITUREN UND INNENLAGER CHAINWHEEL SETS AND BOTTOM BRACKET

ART.-NR. 	BESCHREIBUNG	DESCRIPTION	
<b>350715</b> AD 20 set	<b>KETTENRADGARNITUR</b> <ul style="list-style-type: none"> <li>• für 12"</li> <li>• 1/2" x 1/8"</li> <li>• schwarz</li> <li>• Kurbellänge: 89 mm</li> <li>• JIS</li> <li>• <b>28 Zähne</b></li> <li>• Innenlagerlänge: 127 mm</li> <li>• Montageverpackung</li> </ul>	<b>CHAINWHEEL SET</b> <ul style="list-style-type: none"> <li>• for 12"</li> <li>• 1/2" x 1/8"</li> <li>• black</li> <li>• crank length: 89 mm</li> <li>• JIS</li> <li>• <b>28 teeth</b></li> <li>• B.B. set length: 127 mm</li> <li>• OEM</li> </ul>	
<b>350740</b> AD  <b>350741</b> AD  <b>350742</b> AD  <b>350743</b> AD 10 set	<b>KETTENRADGARNITUR</b> <ul style="list-style-type: none"> <li>• JIS</li> <li>• 1/2" x 1/8"</li> <li>• Kurbellänge: 170 mm</li> <li>• Innenlagerlänge: 127 mm</li> <li>• Montageverpackung</li> </ul> <p>46 Zähne, verchromt</p> <p>44 Zähne, verchromt</p> <p>46 Zähne, schwarz</p> <p>44 Zähne, schwarz</p>	<b>CHAINWHEEL SET</b> <ul style="list-style-type: none"> <li>• JIS</li> <li>• 1/2" x 1/8"</li> <li>• crank length: 170 mm</li> <li>• B.B. set length: 127 mm</li> <li>• OEM</li> </ul> <p>46 teeth, c.p.</p> <p>44 teeth, c.p.</p> <p>46 teeth, black</p> <p>44 teeth, black</p>	
<b>359704</b> 10 set	<b>KETTENRADGARNITUR</b> <ul style="list-style-type: none"> <li>• für Keilachse</li> <li>• 1/2" x 1/8"</li> <li>• Kurbellänge: 170 mm</li> <li>• verchromt</li> <li>• 46 Zähne</li> <li>• mit Thompson-Keil-Innenlager</li> <li>• <b>komplett</b> verpackt im Polybeutel</li> </ul>	<b>CHAINWHEEL SET</b> <ul style="list-style-type: none"> <li>• for <b>cottered axle</b></li> <li>• 1/2" x 1/8"</li> <li>• crank length: 170 mm</li> <li>• c.p.</li> <li>• 46 teeth</li> <li>• with Thompson cottered B.B. set</li> <li>• <b>complete</b> in PE bag</li> </ul>	
<b>350781</b> AD 20 set	wie Art. 359704, ohne Innenlager	like art. 359704, w/o B.B. set	<p>UVP 9,90 € UVP mAD 14,90 €</p>
<b>359191</b> 50 set	<b>THOMPSON-KEIL-INNENLAGER</b> <ul style="list-style-type: none"> <li>• mit Konen, Schalen (40 mm) und Kugelringen</li> <li>• Keilachse 148 mm</li> <li>• Ø 15,8 mm</li> <li>• im Einzelkarton</li> </ul>	<b>THOMPSON COTTERED B.B. SET</b> <ul style="list-style-type: none"> <li>• with cones, cups (40 mm) and ball retainers</li> <li>• cottered axle 148 mm</li> <li>• Ø 15.8 mm</li> <li>• in box</li> </ul>	 <p>UVP 4,90 €</p>
<b>359395</b> 50	<b>BMX KETTENBLATT</b> <ul style="list-style-type: none"> <li>• Stahl</li> <li>• 44 Zähne</li> <li>• 1/2" x 1/8"</li> <li>• schwarz</li> <li>• Montageverpackung</li> </ul>	<b>BMX CHAINRING</b> <ul style="list-style-type: none"> <li>• steel</li> <li>• 44 teeth</li> <li>• 1/2" x 1/8"</li> <li>• black</li> <li>• OEM</li> </ul>	 <p>UVP 3,90 €</p>
<b>359393</b> 25	<b>BMX KURBEL</b> <ul style="list-style-type: none"> <li>• Stahl verchromt</li> <li>• Gewinde links 7/8" x 24 TPI</li> <li>• Gewinde rechts 15/16" x 24 TPI</li> <li>• Länge 152 mm</li> <li>• Pedalgewinde 1/2"</li> <li>• Montageverpackung</li> </ul>	<b>BMX CRANKSET</b> <ul style="list-style-type: none"> <li>• steel c.p.</li> <li>• left thread 7/8" x 24 TPI</li> <li>• right thread 15/16" x 24 TPI</li> <li>• length 152 mm</li> <li>• pedal thread 1/2"</li> <li>• OEM</li> </ul>	 <p>UVP 5,90 €</p>
<b>359396</b> 50 set	<b>BMX INNENLAGER SET</b> <ul style="list-style-type: none"> <li>• Stahl verchromt</li> <li>• für Gehäusebreite 65 - 68 mm</li> <li>• Schalendurchmesser 51 mm (2")</li> <li>• passend für Kurbel Art. 359393, ...</li> <li>• im Einzelkarton</li> </ul>	<b>BMX BOTTOM BRACKET SET</b> <ul style="list-style-type: none"> <li>• steel c.p.</li> <li>• for housing width 65 - 68 mm</li> <li>• cup diameter 51 mm (2")</li> <li>• fits for crankset art. 359393, ...</li> <li>• in box</li> </ul>	 <p>UVP 3,90 €</p>

Lebensdauer des Antriebs bei E-Bikes mit Mittelmotor

Drive durability of e-bikes with mid-mounted engine

e101 EPT / KMC Ritzel breit (1/2 x 1/8")

10.000 km +

powered by

e1 EPT / KMC Ritzel schmal 3.500 km +

powered by

Standard

- + signifikante **Erhöhung der Lebensdauer** der Antriebseinheit durch die **abgestimmte Kombination** von **Kette und Kettenblatt**
- + **garantierete Haltbarkeit von über 10.000 km**

- + significant **increase of lifetime** of the drive unit through the **matched combination** of **chain and chainring**
- + **guaranteed durability of more than 10,000 km**

ART.-NR.	BESCHREIBUNG	DESCRIPTION
	<b>KETTENBLÄTTER</b> • CrMo • schwarz	<b>CHAINRINGS</b> • CrMo • black
<b>Zähne/ teeth</b>	<b>Bosch</b> <b>E-Bikemotoren</b> Generation 2 <b>e-bike engines</b> generation 2	<b>Shimano</b> <b>Schaltungs-naben</b> <b>circuit hubs</b>
	1/2 x 1/8"      1/2 x 11/128"	1/2 x 1/8"      1/2 x 3/32"
	AM      AM	AM      AM      OEM
<b>15</b>		<b>350079</b>
<b>17</b>		<b>350087      350090</b>
<b>18</b>	<b>350075</b>	<b>350083      350094      350088      350091</b>
<b>19</b>	<b>350076</b>	<b>350084      350095      350089      350092</b>
<b>20</b>	<b>350077</b>	<b>350085      350096      350097      350093</b>
<b>21</b>	<b>350078</b>	<b>350086</b>
	25	25      25      25      100
<b>UVP</b>	13,90 €	11,90 €      12,90 €      11,90 €      11,90 €

BOSCH ✓

SHIMANO ✓

NUVINCI ✓





ART.-NR.	BESCHREIBUNG	DESCRIPTION
	<b>KETTENBLÄTTER</b> <ul style="list-style-type: none"> <li>• schwarz</li> <li>• Lochkreis 104 mm</li> <li>• für Brose, Bosch, Shimano, ...</li> <li>• für Schaltungsketten 1/2 x 3/32" &amp; 11/128"</li> <li>• gerade, nicht gekröpft</li> </ul>	<b>CHAINRINGS</b> <ul style="list-style-type: none"> <li>• black</li> <li>• BCD 104 mm</li> <li>• for Brose, Bosch, Shimano, ...</li> <li>• for 1/2 x 3/32" &amp; 11/128" chains</li> <li>• 0 offset</li> </ul>



32 - 40 Zähne / teeth

Zähne / teeth	Stahl steel		Stahl / Narrow Wide steel / narrow wide		Aluminium / Narrow Wide aluminium / narrow wide	
	AM	OEM	AM	OEM	AM	OEM
32			<b>356213</b>	<b>356202</b>	<b>356243</b>	<b>356238</b>
34			<b>356214</b>	<b>356230</b>	<b>356244</b>	<b>356229</b>
36	<b>356204</b>	<b>356201</b>	<b>356215</b>	<b>356203</b>	<b>356245</b>	<b>356239</b>
UVP	8,90 €	8,90 €	18,90 €	18,90 €	32,90 €	32,90 €
38	<b>352682</b>	<b>352685</b>	<b>356216</b>	<b>356232</b>	<b>356246</b>	<b>356231</b>
40	<b>356205</b>	<b>356220</b>	<b>356217</b>	<b>356235</b>	<b>356247</b>	<b>356240</b>
42	<b>352683</b>	<b>352686</b>	<b>356218</b>	<b>356236</b>	<b>356248</b>	<b>356241</b>
44	<b>352684</b>	<b>352687</b>	<b>356219</b>	<b>356226</b>		
46	<b>356206</b>	<b>356228</b>	<b>356242</b>	<b>356237</b>		
UVP	8,90 €	8,90 €	23,90 €	23,90 €	39,90 €	39,90 €



42 - 46 Zähne / teeth



ART.-NR.	BESCHREIBUNG	DESCRIPTION
	<b>DIRECT MOUNTS</b> <ul style="list-style-type: none"> <li>• schwarz</li> <li>• für Schaltungsketten 1/2 x 3/32" &amp; 11/128"</li> <li>• Stahl</li> </ul>	<b>DIRECT MOUNTS</b> <ul style="list-style-type: none"> <li>• black</li> <li>• for 1/2 x 3/32" &amp; 11/128" chains</li> <li>• steel</li> </ul>

Zähne / teeth	Bosch* GEN 2		Bosch* GEN 3 Kettenlinie / chainline 47 mm		Bosch* GEN 4 Kettenlinie / chainline 50 mm Narrow Wide	
	AM	OEM	AM	OEM	AM	OEM
15	<b>356264</b>	<b>356263</b>				
16	<b>356283</b>	<b>356281</b>				
17	<b>356284</b>	<b>356282</b>				
34					<b>356252</b>	<b>356210</b>
36					<b>356253</b>	<b>356211</b>
38			<b>356249</b>	<b>356207</b>	<b>356254</b>	<b>356212</b>
40			<b>356250</b>	<b>356208</b>		
42			<b>356251</b>	<b>356209</b>		
UVP	4,90 €	4,90 €	8,90 €	8,90 €	23,90 €	23,90 €



Bosch GEN 2



Bosch GEN 3



Bosch GEN 4



Weitere Größen und Designs auf Wunsch erhältlich.

\*kein original Bosch Ersatzteil

Other sizes and designs available on request

\*no original Bosch spare part



ART.-NR.	BESCHREIBUNG	DESCRIPTION				
	<b>KETTENSCHUTZ</b> • Aluminium • schwarz eloxiert • Lochkreis 104 mm	<b>CHAINGUARD</b> • aluminium • black anodized • BCD 104 mm				
Zähne / teeth	CHAINGUARD 104		CHAINGUARD 104SL		CHAINGUARD 104CNC	
	AM	OEM	AM	OEM	AM	OEM
<b>NEW</b> 32		<b>356370</b>				
<b>NEW</b> 34		<b>356371</b>				
36					<b>356256</b>	<b>356278</b>
38					<b>356257</b>	<b>356279</b>
40	<b>356255</b>	<b>356273</b>			<b>356258</b>	<b>356280</b>
42			<b>356261</b>	<b>356272</b>		
44			<b>356259</b>	<b>356275</b>		
46			<b>356260</b>	<b>356276</b>		
48				<b>356274</b>		
<b>UVP</b>	13,90 €	13,90 €	15,90 €	15,90 €	20,90 €	20,90 €
	100	50	30	50	100	50

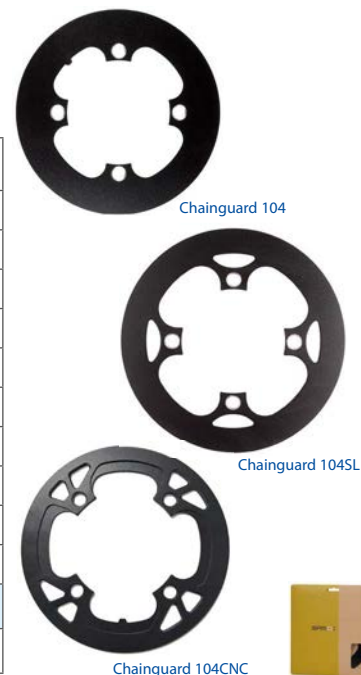

KETTENBLATTSCHRAUBEN	CHAINRING BOLTS	
	<b>AM</b> (4 Stück im Polybeutel mit Samox Eurolochheader / 4 pieces in PE bag with Samox eurohole header)	<b>OEM</b>
<b>M8 x 0,75 x L6,35 mm</b> (Verwendung ohne Kettenschutz / usage without chainguard)	<b>356304</b>	<b>356300</b>
<b>M8 x 0,75 x L7 mm</b> (Verwendung ohne Kettenschutz / usage without chainguard)	<b>356305</b>	<b>356301</b>
<b>M8 x 0,75 x L8 mm</b> (Verwendung mit und ohne Kettenschutz / usage with and without chainguard)	<b>356306</b>	<b>356302</b>
<b>M8 x 0,75 x L10,3 mm</b> (Verwendung mit Kettenschutz / usage with chainguard)	<b>356307</b>	<b>356303</b>
<b>UVP</b>	2,90 € / Set	0,69 € / St
	50	1.000/40



KETTENBLATTMUTTERN	CHAINRING NUTS	
	<b>AM</b> (4 Stück im Polybeutel mit Samox Eurolochheader / 4 pieces in PE bag with Samox eurohole header)	<b>OEM</b>
<b>M8 x 0,75 x L3,7 mm</b> (Verwendung ohne Kettenschutz / usage without chainguard)	<b>356310</b>	<b>356308</b>
<b>M8 x 0,75 x L6,7 mm</b> (Verwendung mit Kettenschutz / usage with chainguard)	<b>356311</b>	<b>356309</b>
<b>UVP</b>	2,90 € / Set	0,69 € / St
	50	1.000/40

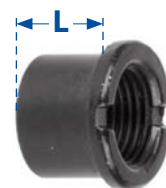

<b>356291</b> AD	<b>SET AUS KETTENBLATT-SCHRAUBEN UND KETTENBLATTMUTTERN</b> Set aus 4x Schraube M8 x 6,25 mm und 4x Mutter M8 x 5 mm, Verwendung ohne Kettenschutz, im Polybeutel	<b>SET OF CHAINRING BOLTS AND CHAINRING NUTS</b> set of 4x screw M8 x 6.25 mm and 4x nut M8 x 5 mm, usage without chainguard, in PE bag
<b>356293</b> AD 500 set	Set aus 4x Schraube M8 x 8 mm und 4x Mutter M8 x 7 mm, Verwendung mit Kettenschutz, im Polybeutel	set of 4x screw M8 x 8 mm and 4x nut M8 x 7 mm, usage with chainguard, in PE bag
	Weitere Größen und Designs auf Wunsch erhältlich.	Other sizes and designs available on request. UVP 4,90 € UVP mAD 8,90 €

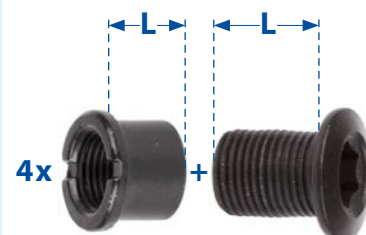





ART.-NR.	BESCHREIBUNG	DESCRIPTION																																							
	<b>SPIDER FÜR E-BIKE MOTOREN VON BROSE*</b> <ul style="list-style-type: none"> <li>Aluminium</li> <li>schwarz eloxiert</li> <li>Lochkreis 104 mm</li> </ul>	<b>SPIDER FOR E-BIKE ENGINES OF BROSE*</b> <ul style="list-style-type: none"> <li>aluminium</li> <li>black anodized</li> <li>BCD 104 mm</li> </ul>																																							
	<table border="1"> <thead> <tr> <th rowspan="2">für Kettenlinie for chainline</th> <th colspan="2">mit Kettenschutzaufnahme with chainguard mounting</th> <th colspan="2">ohne Kettenschutzaufnahme without chainguard mounting</th> </tr> <tr> <th>NEW AM</th> <th>OEM</th> <th>NEW AM</th> <th>OEM</th> </tr> </thead> <tbody> <tr> <td>45</td> <td>613530</td> <td>613524</td> <td>613531</td> <td>613502</td> </tr> <tr> <td>47</td> <td>613532</td> <td>613522</td> <td>613533</td> <td>613523</td> </tr> <tr> <td>49</td> <td>613534</td> <td>613520</td> <td>613535</td> <td>613521</td> </tr> <tr> <td>52</td> <td></td> <td></td> <td>613536**</td> <td>613501**</td> </tr> <tr> <td>UVP</td> <td>22,90 €</td> <td>22,90 €</td> <td>22,90 €</td> <td>22,90 €</td> </tr> <tr> <td></td> <td>80</td> <td>80</td> <td>80</td> <td>80</td> </tr> </tbody> </table>	für Kettenlinie for chainline	mit Kettenschutzaufnahme with chainguard mounting		ohne Kettenschutzaufnahme without chainguard mounting		NEW AM	OEM	NEW AM	OEM	45	613530	613524	613531	613502	47	613532	613522	613533	613523	49	613534	613520	613535	613521	52			613536**	613501**	UVP	22,90 €	22,90 €	22,90 €	22,90 €		80	80	80	80	
für Kettenlinie for chainline	mit Kettenschutzaufnahme with chainguard mounting		ohne Kettenschutzaufnahme without chainguard mounting																																						
	NEW AM	OEM	NEW AM	OEM																																					
45	613530	613524	613531	613502																																					
47	613532	613522	613533	613523																																					
49	613534	613520	613535	613521																																					
52			613536**	613501**																																					
UVP	22,90 €	22,90 €	22,90 €	22,90 €																																					
	80	80	80	80																																					
	**z. B. für MTB Linkage-Akku Rahmen mit Boost Standard	**e. g. for MTB Linkage battery frames with boost standard																																							

<b>SPIDER FÜR E-BIKE MOTOREN VON BOSCH*</b> <ul style="list-style-type: none"> <li>Aluminium</li> <li>ohne Kettenschutzaufnahme</li> <li>schwarz eloxiert</li> <li>Lochkreis 104 mm</li> </ul>	<b>SPIDER FOR E-BIKE ENGINES OF BOSCH*</b> <ul style="list-style-type: none"> <li>aluminium</li> <li>without chainguard mounting</li> <li>black anodized</li> <li>BCD 104 mm</li> </ul>
für BOSCH GEN3 System, Kettenlinie <b>47 mm</b> Montageverpackung <b>613513</b> <b>613537</b> im Polybeutel mit Samox Eurolochheader <b>NEW</b>	for BOSCH GEN3 system, chainline <b>47 mm</b> OEM in PE bag with Samox eurohole header UVP 14,90 €
für BOSCH GEN4 System, Kettenlinie <b>50 mm</b> Montageverpackung <b>613514</b> <b>613538</b> im Polybeutel mit Samox Eurolochheader <b>NEW</b> 80	for BOSCH GEN4 system, chainline <b>50 mm</b> OEM in PE bag with Samox eurohole header UVP 25,90 €

<b>SPIDER FÜR E-BIKE MOTOREN VON SHIMANO*</b> <ul style="list-style-type: none"> <li>Aluminium</li> <li>mit Kettenschutzaufnahme</li> <li>schwarz eloxiert</li> <li>Lochkreis 104 mm</li> </ul>	<b>SPIDER FOR E-BIKE ENGINES OF SHIMANO*</b> <ul style="list-style-type: none"> <li>aluminium</li> <li>with chainguard mounting</li> <li>black anodized</li> <li>BCD 104 mm</li> </ul>
für Shimano E6000, Kettenlinie <b>47 mm</b> Montageverpackung <b>613511</b> <b>613539</b> im Polybeutel mit Samox Eurolochheader <b>NEW</b>	for Shimano E6000, chainline <b>47 mm</b> OEM in PE bag with Samox eurohole header UVP 22,90 €
für Shimano E5000, Kettenlinie <b>47 mm</b> Montageverpackung <b>613510</b> <b>613540</b> im Polybeutel mit Samox Eurolochheader <b>NEW</b> 10	for Shimano E5000, chainline <b>47 mm</b> OEM in PE bag with Samox eurohole header UVP 22,90 €

für Shimano E6100, Kettenlinie <b>47 mm</b> Montageverpackung <b>613512</b> <b>613543</b> im Polybeutel mit Samox Eurolochheader <b>NEW</b>	for Shimano E6100, chainline <b>47 mm</b> OEM in PE bag with Samox eurohole header UVP 27,90 €
für Shimano E7000 / 8000, Kettenlinie <b>50 mm</b> Montageverpackung <b>613508</b> <b>613541</b> im Polybeutel mit Samox Eurolochheader <b>NEW</b>	for Shimano E7000 / 8000, chainline <b>50 mm</b> OEM in PE bag with Samox eurohole header UVP 26,90 €
für Shimano E7000 / 8000, Kettenlinie <b>53 mm</b> Montageverpackung <b>613509</b> <b>613542</b> im Polybeutel mit Samox Eurolochheader <b>NEW</b> 10	for Shimano E7000 / 8000, chainline <b>53 mm</b> OEM in PE bag with Samox eurohole header UVP 26,90 €

\*kein original Shimano / Bosch / Brose Ersatzteil

\*no original Shimano / Bosch / Brose spare part

ART.-NR.	BESCHREIBUNG	DESCRIPTION
	<p><b>KURBEL MIT ISIS AUFNAHME FÜR BOSCH GEN1+2+4, BROSE*, ...</b></p> <ul style="list-style-type: none"> <li>Aluminium, schwarz</li> </ul> <p><small>*kein original Shimano / Bosch / Brose Ersatzteil</small></p>	<p><b>CRANK, ISIS TYPE FOR BOSCH GEN1+2+4, BROSE*, ...</b></p> <ul style="list-style-type: none"> <li>aluminium, black</li> </ul> <p><small>*no original Shimano / Bosch / Brose spare part</small></p>



Länge / length	links / left		rechts / right		Offset	
	AM	OEM	AM	OEM		
<b>SHAPE 1</b>						
170	356108	356127	356109	356126	0 mm	
175	356110	356125	356111	356124		
170	356112	356123	356113	356122	5 mm	
175	356114	356121	356115	356120		
UVP	12,90 €	11,90 €	12,90 €	11,90 €		
170				356167	13 mm	
UVP				16,90 €		
	50	50	50	50		

SHAPE 1

Länge / length	links / left		rechts / right		Offset	
	AM	OEM	AM	OEM		
<b>SHAPE 2</b>						
160	356150		356161		5 mm	
165	356152		356153			
UVP		15,90 €		15,90 €		
170		356191		356192	13 mm	
160	356116	356135	356117	356133		
165	356148		356149			
170	356118	356134	356119	356132		
UVP	12,90 €	11,90 €	12,90 €	11,90 €		
	50	50	50	50		





SHAPE 2

ART.-NR.	BESCHREIBUNG	DESCRIPTION
	<p><b>KURBEL MIT BNI AUFNAHME (MINI-ISIS), BOSCH GEN3*</b></p> <ul style="list-style-type: none"> <li>Aluminium, schwarz</li> </ul> <p><small>*kein original Shimano / Bosch / Brose Ersatzteil</small></p>	<p><b>CRANK, BNI TYPE (MINI-ISIS), BOSCH GEN3*</b></p> <ul style="list-style-type: none"> <li>aluminium, black</li> </ul> <p><small>*no original Shimano / Bosch / Brose spare part</small></p>



Länge / length	links / left		rechts / right		Offset	
	AM	OEM	AM	OEM		
160	356140	356131	356141	356129	5 mm	
170	356142	356130	356143	356128		
UVP	12,90 €	11,90 €	12,90 €	11,90 €		
	50	50	50	50		

SHAPE 1

ART.-NR.	BESCHREIBUNG	DESCRIPTION				
	<b>KURBEL, FÜR SHIMANO 24 MM AXLEN (SHIMANO E8000 / 7000 / 6100)*</b> <ul style="list-style-type: none"> <li>Aluminium, schwarz</li> <li>passend auch für Hollowtech II Kurbeln</li> </ul>	<b>CRANK, FOR SHIMANO 24 MM AXLES (SHIMANO E8000 / 7000 / 6100)*</b> <ul style="list-style-type: none"> <li>aluminium, black</li> <li>also suitable for Hollowtech II cranks</li> </ul>				
<b>Länge / length</b>	<b>links / left</b>		<b>rechts / right</b>		<b>Offset</b>	
	AM	OEM	AM	OEM		
<b>165</b>	<b>356144</b>	<b>356139</b>	<b>356145</b>	<b>356138</b>	<b>13 mm</b>	
<b>175</b>	<b>356146</b>	<b>356137</b>	<b>356147</b>	<b>356136</b>		
<b>UVP</b>	15,90 €	14,90 €	15,90 €	14,90 €		
	50	50	50	50		<b>SHAPE 3</b>

Die Kurbeln sind auf Wunsch auch in weiteren Längen, Offsets und Designs erhältlich.  
\*kein original Shimano / Bosch / Brose Ersatzteil

The cranks are also available on request in other lengths, offsets and designs.  
\*no original Shimano / Bosch / Brose spare part

<b>352660</b> 50	<b>KURBELARM</b> <ul style="list-style-type: none"> <li>Aluminium</li> <li>170 mm</li> <li>JIS</li> <li>Montageverpackung</li> </ul> <ul style="list-style-type: none"> <li>links</li> <li>Offset: 13 mm</li> <li>silber poliert</li> <li>für Art. 351236/37/40, 350650/1/2/3</li> </ul>	<b>CRANK</b> <ul style="list-style-type: none"> <li>aluminium</li> <li>170 mm</li> <li>JIS</li> <li>OEM</li> </ul> <ul style="list-style-type: none"> <li>left</li> <li>offset: 13 mm</li> <li>silver polished</li> <li>für art. 351236/37/40 350650/1/2/3</li> </ul>	UVP 9,90 €		
<b>352602</b>	Offset: 0 mm links, schwarz	offset: 0 mm left, black			
<b>352603</b> 50	rechts, schwarz	right, black			UVP 9,90 €
<b>352671</b>	<b>KURBELARM</b> <ul style="list-style-type: none"> <li>Aluminium</li> <li>170 mm</li> <li>links</li> <li>JIS, um 45° gedreht</li> <li>Offset: 20 mm</li> <li>Montageverpackung</li> </ul> schwarz, für Art. 350680	<b>CRANK</b> <ul style="list-style-type: none"> <li>aluminium</li> <li>170 mm</li> <li>left</li> <li>JIS, turned by 45°</li> <li>offset: 20 mm</li> <li>OEM</li> </ul> black, for art. 350680	UVP 8,90 €		
<b>352672</b> 50	silber, für Art. 350671	silver, for art. 350671			
<b>352661</b>	<b>KURBELARM</b> <ul style="list-style-type: none"> <li>Aluminium</li> <li>JIS</li> <li>Offset: 20 mm</li> <li>Montageverpackung</li> <li>170 mm</li> </ul> links, silber poliert	<b>CRANK</b> <ul style="list-style-type: none"> <li>aluminium</li> <li>JIS</li> <li>offset: 20 mm</li> <li>OEM</li> <li>170 mm</li> </ul> left, silver polished			
<b>352662</b>	links, schwarz	left, black			
<b>352667</b>	rechts, schwarz	right, black			
<b>352681</b>	<b>175 mm</b> links, silber poliert	<b>175 mm</b> left, silver polished	UVP 8,90 €		
<b>352688</b> 50	links, schwarz	left, black			
<b>352663</b> 50	<b>KURBELARM</b> <ul style="list-style-type: none"> <li>Stahl kunststoffummantelt</li> <li>170 mm</li> <li>links</li> <li>JIS</li> <li>schwarz</li> <li>Montageverpackung</li> </ul>	<b>CRANK</b> <ul style="list-style-type: none"> <li>steel plastic coated</li> <li>170 mm</li> <li>left</li> <li>JIS</li> <li>black</li> <li>OEM</li> </ul>	UVP 6,90 €		

ART.-NR. 	BESCHREIBUNG	DESCRIPTION	
	<b>KURBELENSCHUTZ ›CRANK BOOTS‹</b> <ul style="list-style-type: none"> <li>zum Schutz gegen Steinschlag, Verkratzen, ...</li> <li>schlagfestes und langlebiges Material</li> <li>leichte und schnelle Montage</li> <li>auf M-Wave Eurolochkarte</li> </ul>	<b>CRANK PROTECTION ›CRANK BOOTS‹</b> <ul style="list-style-type: none"> <li>protection against stone chipping, scratching, ...</li> <li>impact resistant and durable material</li> <li>easy and fast mounting</li> <li>on M-Wave eurohole card</li> </ul>	 <p>M-WAVE</p>
<b>352730</b>	schwarz	black	
<b>352731</b>	rot	red	
100 pair			UVP 4,90 €
	<ul style="list-style-type: none"> <li><b>352639</b> Achsschrauben</li> </ul>	<b>BOLTS</b> <ul style="list-style-type: none"> <li>suitable for <b>Bosch</b> and <b>Brose E-bike</b> cranks (no original Bosch/Brose spare part)</li> <li>also suitable for <b>ISIS</b> bottom bracket with M15 thread</li> <li>10 pieces in PE bag</li> </ul>	 <p>BOSCH ✓ BROSE ✓ ISIS ✓</p>
1.000/10			UVP 1,90 €
	<ul style="list-style-type: none"> <li><b>352630</b> Achsschrauben/-Mutter</li> </ul>	<b>BOLTS AND NUT</b> <ul style="list-style-type: none"> <li>bolt for hollow axle with sealing, chromium plated</li> </ul>	
1.000/100			UVP 1,90 €
	<ul style="list-style-type: none"> <li><b>352633</b> Achsschraube für Hohlachse</li> </ul>	<ul style="list-style-type: none"> <li>bolt for hollow axle</li> </ul>	
1.000/100			UVP 0,89 €
	<ul style="list-style-type: none"> <li><b>352632</b> Achsmutter für 4-Kantachse</li> </ul>	<ul style="list-style-type: none"> <li>nut for cotterless axle</li> </ul>	
2.500/100			UVP 0,79 €
	<b>KURBELKEIL</b> <ul style="list-style-type: none"> <li>verzinkt</li> <li>Ø 9,5 mm</li> <li>mit Mutter und Beilagscheibe</li> </ul>	<b>CRANK COTTER PIN</b> <ul style="list-style-type: none"> <li>zinc plated</li> <li>Ø 9.5 mm</li> <li>with nut and washer</li> </ul>	
<b>352640</b>	mit kurzem Schliff	with short cut	UVP 27,90 €/100
<b>352641</b>	mit langem Schliff	with long cut	UVP 59,90 €/100
1.000/100			
<b>352654</b>	<b>KETTENSCHUTZ ›CHAIN CAGE‹</b> <ul style="list-style-type: none"> <li>Clip-on Ketten- und Hosenschutz für 1/2" x 1/8" Ketten ohne Schaltwerk</li> <li>wird direkt auf die Kette montiert, muss nicht am Rad befestigt werden</li> <li>werkzeuglose und schnelle Montage</li> <li>geräuschreduziert</li> <li>120 Glieder</li> <li>im M-Wave Eurolochbox</li> </ul>	<b>CHAINSLIDER ›CHAIN CAGE‹</b> <ul style="list-style-type: none"> <li>clip-on chain and trousers protection</li> <li>for 1/2" x 1/8" chains w/o rear derailleur</li> <li>mounted directly on the chain, no need to be fixed at the bike</li> <li>toolless and quick mounting</li> <li>noise reduced</li> <li>120 links</li> <li>in M-Wave eurohole box</li> </ul>	 <p>M-WAVE</p>
100			UVP 16,90 €
	<b>KETTENSCHUTZSCHEIBE</b> <ul style="list-style-type: none"> <li>verschiedene Befestigungsmöglichkeiten:</li> <li>- am Gewinde für Staubschutzkappe</li> <li>- Konusbefestigung (Hollowtech II)</li> <li>aus Kunststoff</li> <li>schwarz</li> <li>inkl. Befestigungsmaterial</li> <li>Montageverpackung</li> </ul>	<b>CHAINGUARD</b> <ul style="list-style-type: none"> <li>multiple mounting positions:</li> <li>- at dust cap thread</li> <li>- cone fixation (Hollowtech II)</li> <li>made of plastic</li> <li>black</li> <li>incl. mounting material</li> <li>OEM</li> </ul>	 <p>HOLLOWTECH II ✓</p> <p>M-WAVE</p>
<b>352648</b>	42 - 44 Zähne	42 - 44 teeth	
<b>352649</b>	46 - 48 Zähne	46 - 48 teeth	
100 set			UVP 5,90 €



# KETTENRADGARNITUREN-ZUBEHÖR ACCESSORIES FOR CHAINWHEEL SETS

ART.-NR.	BESCHREIBUNG	DESCRIPTION	
 • <b>356285</b> • <b>356286</b> 100/10	<b>KETTENSCHUTZ</b> <ul style="list-style-type: none"> <li>für <b>Brose Motor Drive S + C + T + TF</b></li> <li>aus <b>Aluminium</b></li> <li>schwarz</li> <li>Montageverpackung</li> </ul> 42 - 44 Zähne 46 - 48 Zähne	<b>CHAINGUARD</b> <ul style="list-style-type: none"> <li>for <b>Brose Motor Drive S + C + T + TF</b></li> <li>made of <b>aluminium</b></li> <li>black</li> <li>OEM</li> </ul> 42 - 44 teeth 46 - 48 teeth	 <b>BROSE</b> ✓  UVP 9,90 €
<b>NEW</b> <b>352768</b> <b>352769</b> 300/100	<b>HALTER FÜR KETTENSCHUTZ</b> <ul style="list-style-type: none"> <li>für <b>Brose Gen 2</b></li> <li>Montageverpackung</li> </ul> passend zu Art. 356285 (44 - 48 Zähne) passend zu Art. 356285 & 356298 (bis 44 Zähne)	<b>BRACKET FOR CHAINGUARD</b> <ul style="list-style-type: none"> <li>for <b>Brose Gen 2</b></li> <li>OEM</li> </ul> suitable for art. 356285 (44 - 48 teeth) suitable for art. 356285 & 356298 (up to 44 teeth)	 UVP 49,90 €
• <b>356298</b> 4.000/100	<b>HALTEWINKEL</b> <ul style="list-style-type: none"> <li>zur Befestigung des Kettenschutzes an der Sitzrohrstrebe oder am Ausfallende</li> <li>aus <b>Aluminium</b></li> <li>passend zu Art. 356285/6</li> <li>schwarz</li> <li>inkl. Befestigungsmaterial</li> <li>Montageverpackung</li> </ul>	<b>ANGLE BRACKET</b> <ul style="list-style-type: none"> <li>for fixing the chainguard at the seat stay or at the drop out</li> <li>made of <b>aluminium</b></li> <li>suitable for art. 356285/6</li> <li>black</li> <li>incl. mounting material</li> <li>OEM</li> </ul>	  UVP 0,99 €
<b>352780</b> <b>352781</b> <b>352782</b> 50	<b>KETTENSCHUTZ</b> <ul style="list-style-type: none"> <li><b>schwarz</b></li> <li>aus Kunststoff</li> <li>inkl. Stahlhalter</li> <li>Montageverpackung</li> </ul> 33 - 38 Zähne (Ersatzschraube M4x8 mm: Art. 352637) 38 - 40 Zähne (Ersatzschraube M4x8 mm: Art. 352637) 38 - 48 Zähne (Ersatzschraube M5x8 mm: Art. 352638)	<b>CHAINGUARD</b> <ul style="list-style-type: none"> <li><b>black</b></li> <li>made of plastic</li> <li>incl. steel bracket</li> <li>OEM</li> </ul> 33 - 38 teeth (replacement screw M4x8 mm: art. 352637) 38 - 40 teeth (replacement screw M4x8 mm: art. 352637) 38 - 48 teeth (replacement screw M5x8 mm: art. 352638)	 UVP 5,90 €
<b>325482</b> 1.000	<b>Universal-Bandage</b> mit Schraube und Mutter, passend für (fast) alle Kettenstreben	<b>universal clamp</b> with screw and nut, suitable for (almost) all chain stays	 UVP 0,79 €
<b>352600</b> 100/50	<b>VIERKANT BSA TRETLAGER-ACHSE ›3SS‹</b> <ul style="list-style-type: none"> <li>A: 32, B: 52, C: 37,5, D: 121,5 mm</li> <li>inkl. Muttern</li> <li>JIS</li> <li>für Gehäusebreite 68 mm</li> </ul>	<b>COTTERLESS BSA AXLE ›3SS‹</b> <ul style="list-style-type: none"> <li>A: 32, B: 52, C: 37,5, D: 121.5 mm</li> <li>including nuts</li> <li>JIS</li> <li>for B.B. width 68 mm</li> </ul>	  UVP 3,90 €
<b>352610</b> 100 set	<b>SCHRAUBSCHALEN</b> <ul style="list-style-type: none"> <li>schwarz</li> <li>mit BSA Gewinde</li> <li>linke Schale mit Konterring</li> </ul>	<b>B.B. CUPS</b> <ul style="list-style-type: none"> <li>black</li> <li>with BSA thread</li> <li>left cup with lock ring</li> </ul>	 UVP 2,90 €
<b>352620</b> 2.000/200	<b>KUGELRINGE</b> <ul style="list-style-type: none"> <li>9A x 1/4"</li> <li>für BSA-Innenlager</li> </ul>	<b>BALL RETAINERS</b> <ul style="list-style-type: none"> <li>9A x 1/4"</li> <li>for BSA-B.B. set</li> </ul>	 UVP 0,99 €

ART.-NR.	BESCHREIBUNG	DESCRIPTION	
  <b>BSA KOMPAKT-INNENLAGER FÜR SHIMANO WERKZEUG</b> <ul style="list-style-type: none"> <li>Aluminiumschalen mit Lockseal</li> <li>nur <b>244 g</b> (107,5 mm)</li> <li>Industriekugellager</li> <li>Achsschrauben mit Dichtungsring und Lockseal</li> <li>BSA, JIS</li> </ul> <ul style="list-style-type: none"> <li>silberne <b>CrMo-Hohlachse</b></li> <li>im Neco Karton</li> </ul> <u>L1 / L2</u> <b>359260</b> 107,5/20,5 mm <b>359261</b> 110,5/20,5 mm <b>359262</b> 113,5/23 mm <b>359263</b> 115/24 mm <b>359264</b> 119/27 mm <b>359265</b> 122,5/28,5 mm <b>359266</b> 127,5/31 mm <b>359267</b> 131/34 mm 50	<b>BSA CARTRIDGE B.B. SET FOR SHIMANO TOOL</b> <ul style="list-style-type: none"> <li>aluminium cups and lockseal</li> <li>only <b>244 g</b> (107,5 mm)</li> <li>sealed bearing</li> <li>axle bolts with <b>sealing ring</b> and lockseal</li> <li>BSA, JIS</li> </ul> <ul style="list-style-type: none"> <li>silver <b>CrMo hollow axle</b></li> <li>in Neco box</li> </ul> <u>L1 / L2</u> <b>359260</b> 107,5/20,5 mm <b>359261</b> 110,5/20,5 mm <b>359262</b> 113,5/23 mm <b>359263</b> 115/24 mm <b>359264</b> 119/27 mm <b>359265</b> 122,5/28,5 mm <b>359266</b> 127,5/31 mm <b>359267</b> 131/34 mm UVP 19,90 €	Tested by the manufacturer based on ISO 4210     	
<b>&gt;CAROUSEL BB BSA SQ&lt;</b> <ul style="list-style-type: none"> <li><b>CrMo-Hohlachse, Dacromet</b> beschichtet</li> <li>Aluminiumschalen mit Lockseal</li> <li>nur <b>218 g</b> (107,5 mm)</li> <li>im M-Wave Karton</li> </ul> <u>L1 / L2</u> <b>359450</b> 107,5/20,5 mm <b>359451</b> 110,5/20,5 mm <b>359452</b> 113,5/23 mm <b>359453</b> 115/24 mm <b>359454</b> 119/27 mm <b>359455</b> 122,5/28,5 mm <b>359456</b> 127,5/31 mm 50	<b>&gt;CAROUSEL BB BSA SQ&lt;</b> <ul style="list-style-type: none"> <li><b>CrMo hollow axle, Dacromet</b> coated</li> <li>aluminium cups with lockseal</li> <li>only <b>218 g</b> (107,5 mm)</li> <li>in M-Wave box</li> </ul> <u>L1 / L2</u> <b>359450</b> 107,5/20,5 mm <b>359451</b> 110,5/20,5 mm <b>359452</b> 113,5/23 mm <b>359453</b> 115/24 mm <b>359454</b> 119/27 mm <b>359455</b> 122,5/28,5 mm <b>359456</b> 127,5/31 mm UVP 13,90 €	   	
<ul style="list-style-type: none"> <li>mit <b>Stahlschalen</b></li> <li>schwarze Vollachse</li> <li>Montageverpackung</li> </ul> <u>L1 / L2</u> <b>359270</b> 110,5/20,5 mm <b>359271</b> 113,5/23 mm <b>359272</b> 115/24 mm <b>359273</b> 119/27 mm <b>359274</b> 122,5/28,5 mm <b>359275</b> 127,5/31 mm <b>359276</b> 131/34 mm 50	<ul style="list-style-type: none"> <li>with <b>steel cups</b></li> <li>black massive axle</li> <li>OEM</li> </ul> <u>L1 / L2</u> <b>359270</b> 110,5/20,5 mm <b>359271</b> 113,5/23 mm <b>359272</b> 115/24 mm <b>359273</b> 119/27 mm <b>359274</b> 122,5/28,5 mm <b>359275</b> 127,5/31 mm <b>359276</b> 131/34 mm UVP 8,90 €	Tested by the manufacturer based on ISO 4210  	

ART.-NR.	BESCHREIBUNG	DESCRIPTION
	<b>BSA KOMPAKT-INNENLAGER</b>	<b>BSA CARTRIDGE B.B. SET</b>
	mit <b>Nylonschalen</b> auf beiden Seiten / with <b>nylon</b> cups on both sides	mit <b>Nylon-</b> (links) und <b>Stahlschale</b> (rechts) / with <b>nylon</b> (left) and <b>steel</b> cup (right)
	<b>L1 / L2</b>	
	<ul style="list-style-type: none"> <li>• <b>359350</b></li> <li>• <b>359351</b></li> <li>• <b>359352</b></li> <li>• <b>359353</b></li> <li>• <b>359354</b></li> <li>• <b>359355</b></li> <li>• <b>359356</b> UVP 7,90 €</li> </ul>	<ul style="list-style-type: none"> <li>• <b>359339</b></li> <li>• <b>359340</b></li> <li>• <b>359341</b></li> <li>• <b>359342</b></li> <li>• <b>359343</b></li> <li>• <b>359344</b></li> <li>• <b>359345</b> UVP 7,90 €</li> </ul>
50		
<b>359133</b>	<ul style="list-style-type: none"> <li>• mit <b>Stahlschalen</b></li> <li>• mit italienischem Gewinde 36 x 24 T</li> <li>• 127 / 30,5 mm</li> </ul>	<ul style="list-style-type: none"> <li>• with <b>steel cups</b></li> <li>• with italian thread 36 x 24 T</li> <li>• 127 / 30.5 mm</li> </ul>
50		UVP 6,90 €
<b>359940</b>	<ul style="list-style-type: none"> <li>• für <b>Kurbelkeile</b></li> <li>• mit <b>Stahlschalen</b></li> <li>• <b>136 / 37 mm</b></li> <li>• BSA</li> </ul>	<ul style="list-style-type: none"> <li>• fixed by <b>crank cotter pins</b></li> <li>• with <b>steel cups</b></li> <li>• <b>136 / 37 mm</b></li> <li>• BSA</li> </ul>
50		UVP 6,90 €
	<b>KOMPAKT-INNENLAGER</b>	<b>CARTRIDGE B.B. SET</b>
	<ul style="list-style-type: none"> <li>• mit <b>Kunststoffschalen</b></li> <li>• <b>Industriekugellager</b></li> <li>• schwarze <b>Boron-Achse</b></li> <li>• mit viel Platz für Lichtkabelführung, ...</li> <li>• BSA, JIS</li> <li>• passend für Shimano Werkzeug</li> <li>• Montageverpackung</li> </ul>	<ul style="list-style-type: none"> <li>• with <b>plastic cups</b></li> <li>• <b>sealed bearing</b></li> <li>• black <b>boron axle</b></li> <li>• with a lot of space for light cable guiding, ...</li> <li>• BSA, JIS</li> <li>• compatible to Shimano tools</li> <li>• OEM</li> </ul>
	<b>L1 / L2</b>	<b>L1 / L2</b>
	<ul style="list-style-type: none"> <li>• <b>359461</b> 110,5 / 20,5 mm</li> <li>• <b>359464</b> 119,0 / 27,0 mm</li> <li>• <b>359465</b> 122,5 / 28,5 mm</li> <li>• <b>359466</b> 127,5 / 31,0 mm</li> <li>• <b>359467</b> 131,0 / 34,0 mm</li> </ul>	<ul style="list-style-type: none"> <li>110.5 / 20.5 mm</li> <li>119.0 / 27.0 mm</li> <li>122.5 / 28.5 mm</li> <li>127.5 / 31.0 mm</li> <li>131.0 / 34.0 mm</li> </ul>
50		UVP 6,90 €

Tested by the manufacturer based on ISO 4210

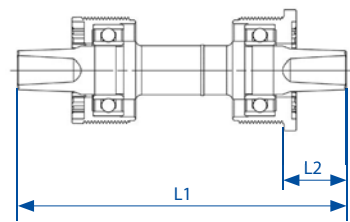





ART.-NR.	BESCHREIBUNG	DESCRIPTION	
Innenlager-gehäuse/ BB shell	<p>BSA</p> <p>BC1,37 24T LH</p> <p>68 or 73</p> <p>BC1,37 24T RH</p>	<p>BB86/92</p> <p>Ø 41</p> <p>86,5 - 92</p>	<p>BB30</p> <p>Ø 42</p> <p>7</p> <p>68/73</p>
Artikel- nummer	<b>359310</b> <b>359311</b> <b>359305</b>	<b>359430</b> <b>359432</b>	<b>359435</b>  <b>359902</b>

### GEWINDE-INNENLAGER

- außenliegende, **CNC-gefräste Aluminium-Lagerschalen**
- BSA
- für 24 mm Achse
- **2 Industriekugellager**
- mit Kunststoff-Innenhülse
- im Polybeutel

- 359310**
- für 68 mm Tretlagergehäuse
  - empfohlen für **Rennrad**-Kettenradgarnituren Art. 351001, ...
  - nur **102 g**

- 359311**  
60/10
- für 68 - 73 mm Tretlagergehäuse (inkl. Adapterringe)
  - empfohlen für **MTB**-Kettenradgarnituren Art. 351232, 351233, ...
  - nur **105 g**

### THREADED BOTTOM BRACKET

- outer, **CNC machined aluminium bearing cups**
- BSA
- for 24 mm axle
- **2 sealed bearings**
- with plastic inner casing
- in PE bag

- for 68 mm bottom bracket housing
- commended for **road** chainwheel sets art. 351001, ...
- only **102 g**

- for 68 - 73 mm bottom bracket housing (incl. adaptor rings)
- commended for **MTB** chainwheel sets art. 351232, 351233, ...
- only **105 g**

UVP 18,90 €

Tested by the manufacturer based on ISO 4210

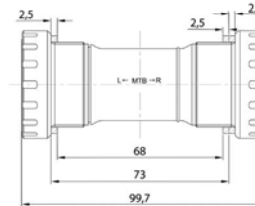
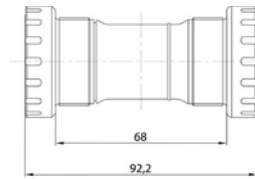

### 359305 GEWINDE-INNENLAGER

50

- **außenliegende, CNC-gefräste Aluminium-Lagerschalen**
- BSA
- für 24 mm Achse
- **2 Industriekugellager**
- nur **106 g**
- für **Shimano Hollowtech II, Race Face, ...** -Tretlager (kein original Shimano / Race Face Ersatzteil)
- für 68-73 mm Gehäusebreite, inkl. Spacer
- im Neco Einzelkarton

### THREADED BOTTOM BRACKET

- outer, **CNC machined aluminium bearing cups**
- BSA
- for 24 mm axle
- **2 sealed bearings**
- only **106 g**
- for **Shimano Hollowtech II, Race Face, ...** crankssets (no original Shimano / Race Face spare part)
- for 68-73 mm b.b. housing width, incl. spacer
- in Neco box

UVP 29,90 €



**neco**

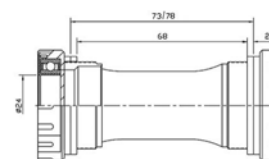





# BRAKES AND PARTS

CAF















ART.-NR. 	BESCHREIBUNG	DESCRIPTION	
<b>NEW</b>	<b>SCHEIBENBREMSE HYDRAULISCH ›DBH-2‹</b>	<b>DISC BRAKE HYDRAULIC ›DBH-2‹</b>	
	<ul style="list-style-type: none"> <li>• <b>2-Kolben-Bremse</b></li> <li>• kompakte Bauweise</li> <li>• für Mineralöl</li> <li>• <b>kaltgeschmiedetes Aluminium</b></li> <li>• <b>selbstjustierende Kolben</b></li> <li>• <b>Griffweite einstellbar</b></li> <li>• mit kürzbarer Hydraulikleitung, Ø 5 mm</li> <li>• mit Ersatzpin und Olive</li> <li>• für Postmount System</li> <li>• Montageverpackung</li> </ul>	<ul style="list-style-type: none"> <li>• <b>Dual Piston brake</b></li> <li>• compact construction</li> <li>• for mineral oil</li> <li>• <b>cold forged aluminium</b></li> <li>• <b>self-adjusting pistons</b></li> <li>• <b>adjustable reach</b></li> <li>• hydraulic hose can be shortened, Ø 5 mm</li> <li>• with replacement pin and olive</li> <li>• for postmount system</li> <li>• OEM</li> </ul>	
<b>360718</b>	<ul style="list-style-type: none"> <li>• für <b>VR</b></li> <li>• 900 mm Leitung</li> </ul>	<ul style="list-style-type: none"> <li>• for <b>front</b></li> <li>• 900 mm tube</li> </ul>	
<b>360719</b> 40 set	<ul style="list-style-type: none"> <li>• für <b>HR</b></li> <li>• 1.600 mm Leitung</li> </ul>	<ul style="list-style-type: none"> <li>• for <b>rear</b></li> <li>• with 1,600 mm tube</li> </ul>	<p>UVP 41,90 € UVP mAD 61,90 €</p>

<b>360692</b> 50 set	<b>WARTUNGSSET FÜR SCHEIBENBREMSEN ›BLEEDBOX‹</b>	<b>BLEEDING KIT FOR DISC BRAKES ›BLEEDBOX‹</b>	
	<ul style="list-style-type: none"> <li>• 2 x Spritze 25 ml</li> <li>• 2 x M5 Adapter</li> <li>• 2 x M6 Adapter</li> <li>• 2 x O-Ring für DOT 4 Bremsflüssigkeit</li> <li>• 2 x O-Ring für Mineralöl</li> <li>• Leitungsschneider</li> <li>• Entlüftungs-Distanzstück (für Promax-Scheibenbremsen)</li> <li>• im M-Wave Einzelkarton</li> </ul>	<ul style="list-style-type: none"> <li>• 2 x syringe 25 ml</li> <li>• 2 x M5 adapter</li> <li>• 2 x M6 adapter</li> <li>• 2 x O-ring for DOT 4 brake liquid</li> <li>• 2 x O-ring for mineral oil</li> <li>• tube cutter</li> <li>• bleed block (for Promax disc brakes)</li> <li>• in M-Wave box</li> </ul>	
			UVP 23,90 €

<b>360691</b> 20 set	<b>WARTUNGSSET FÜR HYDRAULISCHE SCHEIBEN- BREMSEN ›BRAKE DOC BOX‹</b>	<b>BLEEDING KIT FOR HYDRAULIC DISC BRAKE ›BRAKE DOC BOX‹</b>	
	<ul style="list-style-type: none"> <li>• passend für <b>Shimano</b> Deore XT 2005 - 2007 / 2009-2013 / 2016, Deore LX 2009 - 2013, Deore 2009 - 2013, XTR 2009 - 2013 / 2014 - 2015 / 2016 <b>Hayes</b> Stroker Trail, Stroker Carbon, Stroker Ace, Stroker Gram, El Camino <b>Tektro</b> Auriga Pro, Auriga SUB, Auriga Comp, Auriga Comp WS <b>Magura</b> Louise, Louise FR und Marta <b>Avid</b> Juicy 5/7 und Ultimate <b>Bengal</b> Helix 1.0/1.1, Helix 3 5 L, Helix 3 Carbon</li> <li>• zwei Spritzen (30 ml und 10 ml)</li> <li>• Schlauch-Adapter (4/5/6 mm) und Überwurfmutter</li> <li>• Bremsflüssigkeit DOT 5.1</li> <li>• in M-Wave Aufbewahrungsbox</li> </ul>	<ul style="list-style-type: none"> <li>• suitable for <b>Shimano</b> Deore XT 2005 - 2007 / 2009 - 2013 / 2016, Deore LX 2009 - 2013, Deore 2009 - 2013, XTR 2009 - 2013 / 2014 - 2015 / 2016 <b>Hayes</b> Stroker Trail, Stroker Carbon, Stroker Ace, Stroker Gram, El Camino <b>Tektro</b> Auriga Pro, Auriga SUB, Auriga Comp, Auriga Comp WS <b>Magura</b> Louise, Louise FR and Marta <b>Avid</b> Juicy 5/7 and Ultimate <b>Bengal</b> Helix 1.0/1.1, Helix 3 5 L, Helix 3 Carbon</li> <li>• two syringes (30 ml and 10 ml)</li> <li>• adapters (4/5/6 mm) and swivel nuts</li> <li>• brake liquid DOT 5.1</li> <li>• in M-Wave storage box</li> </ul>	
			UVP 143,00 €

Shimano® Deore XT 2005-2007 XTR 2014-2015  5x	Shimano® Deore XT 2016 XTR 2016  5x	Tektro® Auriga Pro Auriga SUB Auriga Comp Auriga Comp WS  8x	Magura® Louise Louise FR Marta  4x	Bengal® Helix 1.0/1.1 Helix 3 5 L Helix 3 carbon  3x	Hayes® Stroker Trail Stroker Carbon Stroker Ace Stroker Gram El Camino  4x	Avid® Juicy 5/7 Ultimate  4x	 1x	 1x
Shimano® Deore XT 2009-2013 Deore LX 2009-2013 XTR 2009-2013  8x	Überwurfmutter/ swivel nut für/for Shimano® für/for Avid® für/for Sram®  5x	Überwurfmutter/ swivel nut für/for Hayes® für/for Tektro®  5x	Schlauch-Adapter/ adapter for hose fitting 4mm 5mm 6mm  2x	Bremsflüssigkeit DOT 5.1/ brake fluid DOT 5.1  1x	 2x			



ART.-NR.	BESCHREIBUNG	DESCRIPTION	
 <b>360648</b> 10	<b>HYDRAULIKLEITUNG</b> <ul style="list-style-type: none"> <li>geeignet für <b>DOT</b> und <b>Mineralöl</b></li> <li>30 m gerollt</li> </ul> <ul style="list-style-type: none"> <li>Innen-Ø <b>2,5 mm</b>, Außen-Ø 5,5 mm</li> <li>passend für die meisten Modelle von Tektro, Bengal, Hayes</li> </ul>	<b>HYDRAULIC TUBE</b> <ul style="list-style-type: none"> <li>usable with <b>DOT</b> and <b>mineral oil</b></li> <li>30 m rolls</li> </ul> <ul style="list-style-type: none"> <li>inner Ø <b>2.5 mm</b>, outer Ø 5.5 mm</li> <li>suitable for most models from Tektro, Bengal, Hayes</li> </ul>	  UVP 116,00 €
<b>360649</b> 10	<ul style="list-style-type: none"> <li>Innen-Ø <b>2,2 mm</b>, Außen-Ø 5,0 mm</li> <li>passend für die meisten Modelle von Shimano, Magura, Formula</li> </ul>	<ul style="list-style-type: none"> <li>inner Ø <b>2.2 mm</b>, outer Ø 5.0 mm</li> <li>suitable for most models from Shimano, Magura, Formula</li> </ul>	  UVP 116,00 €
<b>880311</b> 100/25	<b>SCHNEIDWERKZEUG FÜR HYDRAULIKLEITUNGEN ›TB-HC20‹</b> <ul style="list-style-type: none"> <li>universell passend</li> <li>sehr <b>sauberer Schnitt</b></li> <li>stabile Kunststoffausführung</li> <li>mit <b>Reserveklinge</b></li> <li>in Super B Blisterverpackung</li> </ul>	<b>HYDRAULIC HOSE CUTTER ›TB-HC20‹</b> <ul style="list-style-type: none"> <li>universally suitable</li> <li>very <b>clean cut</b></li> <li>stable plastic version</li> <li>with <b>replacement blade</b></li> <li>in Super B blister packaging</li> </ul>	    UVP 13,90 €
<b>365900</b> 72	<b>BREMSFLÜSSIGKEIT</b> für hydraulische (Brems-)Systeme (z. B. für Scheibenbremsen von Fahrrädern) <b>Dot 5.1</b> 100 ml Flasche	<b>BRAKE LIQUID</b> for hydraulic (brake) systems (e. g. for bicycle disc brakes) <b>Dot 5.1</b> 100 ml bottle	     UVP 6,90 €
<b>365901</b> 9	1 l Kanister	1 l canister	  UVP 29,90 €
<b>365902</b> 72	<b>Mineralöl</b> 100 ml Flasche	<b>Mineral oil</b> 100 ml bottle	   UVP 5,90 €
<b>365903</b> 11	1 l Kanister	1 l canister	  UVP 19,90 €

ART.-NR. 	BESCHREIBUNG	DESCRIPTION	
<b>360460</b> 25	<b>MECHANISCHER SCHEIBENBREMSKÖRPER</b> <ul style="list-style-type: none"> <li>• für <b>Vorderrad</b> oder <b>Hinterrad</b></li> <li>• <b>Aluminium</b></li> <li>• Zuglänge per Hand einstellbar</li> <li>• passend für Postmount System, passende Adapter siehe Seite 291</li> <li>• Einstellung des Druckpunkts am Bremskörper</li> <li>• inkl. Bremsbeläge (Art. 360590)</li> <li>• Montageverpackung</li> </ul>	<b>MECHANICAL DISC BRAKE CALIPER</b> <ul style="list-style-type: none"> <li>• for <b>front</b> or <b>rear</b></li> <li>• <b>aluminium</b></li> <li>• cable length adjustable without tools</li> <li>• suitable for postmount system, suitable adapters see page 291</li> <li>• pressure point adjustment on caliper</li> <li>• incl. brake pads (art. 360590)</li> <li>• OEM</li> </ul>	 
<b>NICE PRICE</b>  <b>360551</b> 50/5 set	<b>MECHANISCHER SCHEIBENBREMSKÖRPER</b> <ul style="list-style-type: none"> <li>• (für <b>VR</b>)</li> <li>• mit Adapter passend für <b>Postmount System</b> und <b>IS 2000</b> (<b>vorne für 160 mm</b> oder <b>hinten für 140 mm</b> Scheibe)</li> </ul>	<b>MECHANICAL DISC BRAKE CALIPER</b> <ul style="list-style-type: none"> <li>• (for <b>front</b>)</li> <li>• with adapter suitable for <b>postmount system</b> and <b>IS 2000</b> (<b>front for 160 mm</b> or <b>rear for 140 mm</b> disc)</li> </ul>	<p>Tested by the manufacturer based on ISO 4210</p> 
<b>360595</b> 50/5 set	<ul style="list-style-type: none"> <li>• (für <b>HR</b>)</li> <li>• mit Adapter passend für <b>Postmount System</b> und <b>IS 2000</b> (<b>vorne für 180 mm</b> oder <b>hinten für 160 mm</b> Scheibe)</li> </ul>	<ul style="list-style-type: none"> <li>• (for <b>rear</b>)</li> <li>• with adapter suitable for <b>postmount system</b> and <b>IS 2000</b> (<b>front for 180 mm</b> or <b>rear for 160 mm</b> disc)</li> </ul>	
<b>360411</b> 50	<b>MECHANISCHER SCHEIBENBREMSKÖRPER</b> <ul style="list-style-type: none"> <li>• für <b>VR</b> oder <b>HR</b></li> <li>• <b>Flatmount</b></li> <li>• <b>Aluminium</b></li> <li>• 2 Kolben</li> <li>• seitlich über Sechskantschlüssel einstellbar</li> <li>• inkl. Befestigungsschrauben</li> <li>• Montageverpackung</li> </ul>	<b>MECHANICAL DISC BRAKE CALIPER</b> <ul style="list-style-type: none"> <li>• for <b>front</b> or <b>rear</b></li> <li>• <b>flatmount</b></li> <li>• <b>aluminium</b></li> <li>• dual piston</li> <li>• laterally adjustable with an allen key</li> <li>• incl. fixing screws</li> <li>• OEM</li> </ul>	<p>Tested by the manufacturer based on ISO 4210</p> <p><b>✓ FLATMOUNT</b></p> 
<b>360420</b> 100  <b>360421</b> 100  <b>360422</b> 100	<b>SCHEIBENBREMSADAPTER</b> <ul style="list-style-type: none"> <li>• für mechanische <b>Flatmount</b> Scheibenbremsen</li> <li>• <b>Aluminium</b></li> <li>• inkl. Befestigungsschrauben</li> <li>• Montageverpackung</li> </ul> <ul style="list-style-type: none"> <li>• für <b>VR</b></li> <li>• für Ø 140 mm</li> </ul> <ul style="list-style-type: none"> <li>• für <b>VR</b></li> <li>• für Ø 160 mm</li> </ul> <ul style="list-style-type: none"> <li>• für <b>HR</b></li> <li>• für Ø 160 mm</li> </ul>	<b>ADAPTER FOR DISC BRAKE</b> <ul style="list-style-type: none"> <li>• for mechanical <b>flatmount</b> disc brakes</li> <li>• <b>aluminium</b></li> <li>• incl. fixing screws</li> <li>• OEM</li> </ul> <ul style="list-style-type: none"> <li>• for <b>front</b></li> <li>• for Ø 140 mm</li> </ul> <ul style="list-style-type: none"> <li>• for <b>front</b></li> <li>• for Ø 160 mm</li> </ul> <ul style="list-style-type: none"> <li>• for <b>rear</b></li> <li>• for Ø 160 mm</li> </ul>	

ART.-NR.	BESCHREIBUNG	DESCRIPTION
	<p><b>SCHEIBENBREMSADAPTER</b></p> <p>für die Verwendung von Postmount Bremskörpern mit größerer / kleinerer Bremsscheibe, sowie zur Montage an IS2000-Aufnahmen.</p> <p>Passend für alle gängigen Postmount Bremskörper mit 6" Befestigungsschraubenabstand</p> <p>*Postmount-Adapter (Art. 360626-9) inkl. Befestigungsschrauben für Postmount.</p>	<p><b>ADAPTER FOR DISC BRAKE</b></p> <p>for the use of postmount brake calipers with larger / smaller brake disc and for mounting to IS2000 base.</p> <p>Suitable for all common postmount brake calipers with 6" mounting screw distance.</p> <p>*postmount adapters (art. 360626-9) incl. mounting screws for postmount.</p>

Tested by the manufacturer based on ISO 4210



Montagesockel / assembly base			Ø Bremsscheibe / disc			
			140 mm	160 mm	180 mm	203 mm
IS 2000	vorne / front	AM		<b>360621</b> 50	<b>360623</b> 200	<b>360631</b> 100
		OEM		<b>360620</b> 500	<b>360622</b> 500	<b>360630</b> 250
	hinten / rear	AM		<b>360623</b> 200	<b>360625</b> 100	
		OEM		<b>360622</b> 500	<b>360624</b> 250	
Postmount	vorne / front	AM			<b>360627*</b> 100	<b>360629*</b> 200
		OEM			<b>360626*</b> 250	<b>360628*</b> 200
	hinten / rear	AM			<b>360627*</b> 100	<b>360629*</b> 200
		OEM			<b>360626*</b> 250	<b>360628*</b> 100
Flatmount	vorne / front	AM	<b>360434</b> 100	<b>360435</b> 100		
		OEM	<b>360430</b> 100	<b>360431</b> 100		
	hinten / rear	AM	<b>360436</b> 100	<b>360437</b> 100		
		OEM	<b>360432</b> 100	<b>360433</b> 100		













UVP 7,90 €



NEW			CENTERLOCK ADAPTER FÜR BREMSSCHEIBEN ›ADA DB CL‹	CENTER LOCK ADAPTER FOR BRAKE DISCS ›ADA DB CL‹
			<ul style="list-style-type: none"> <li>ermöglicht die Montage von <b>6-Loch Bremsscheiben</b> auf <b>Center Lock Naben</b></li> <li>CNC gefrästes Aluminium</li> </ul>	<ul style="list-style-type: none"> <li>allows the mounting of <b>6-hole brake discs</b> on <b>Center Lock hubs</b></li> <li>CNC machined aluminium</li> </ul>
<b>361120</b>	Montageverpackung			OEM
<b>361121</b> 250	auf M-Wave Eurolockkarte			on M-Wave eurohole card



UVP 16,90 €

ART.-NR. 	BESCHREIBUNG	DESCRIPTION	
<b>360533</b> 50	<b>BREMSSCHEIBE</b> <ul style="list-style-type: none"> <li>• 140 mm</li> <li>• nur 76 g</li> <li>• inkl. Befestigungsschrauben</li> <li>• Montageverpackung</li> </ul>	<b>BRAKE DISC</b> <ul style="list-style-type: none"> <li>• 140 mm</li> <li>• only 76 g</li> <li>• incl. fixing screws</li> <li>• OEM</li> </ul>	<div style="border: 1px solid black; padding: 2px; font-size: 8px;">Tested by the manufacturer based on ISO 4210</div>   
<b>360593</b> 50	<ul style="list-style-type: none"> <li>• 160 mm</li> <li>• nur 96 g</li> <li>• inkl. Befestigungsschrauben</li> <li>• in <b>Promax Blisterverpackung</b></li> <li>• inkl. Vielzahn Schlüssel</li> </ul>	<ul style="list-style-type: none"> <li>• 160 mm</li> <li>• only 96 g</li> <li>• incl. fixing screws</li> <li>• in <b>Promax blister packaging</b></li> <li>• incl. star screwdriver</li> </ul>	 
<b>360556</b> 50	Montageverpackung	OEM	UVP 13,90 €
<b>360594</b> 50	<ul style="list-style-type: none"> <li>• 180 mm</li> <li>• inkl. Befestigungsschrauben</li> <li>• in <b>Promax Blisterverpackung</b></li> <li>• inkl. Vielzahn Schlüssel</li> </ul>	<ul style="list-style-type: none"> <li>• 180 mm</li> <li>• incl. fixing screws</li> <li>• in <b>Promax blister packaging</b></li> <li>• incl. star screwdriver</li> </ul>	 
<b>360597</b> 50	Montageverpackung	OEM	UVP 13,90 €
<b>360632</b> 50	<ul style="list-style-type: none"> <li>• 203 mm</li> <li>• inkl. Befestigungsschrauben</li> <li>• inkl. Vielzahn Schlüssel</li> <li>• in <b>Promax Blisterverpackung</b></li> </ul>	<ul style="list-style-type: none"> <li>• 203 mm</li> <li>• incl. fixing screws</li> <li>• incl. star screwdriver</li> <li>• in <b>Promax blister packaging</b></li> </ul>	 
<b>360632</b> 50	Montageverpackung	OEM	UVP 15,90 €
<b>360645</b> 50 set	<b>BREMSSCHEIBE</b> <ul style="list-style-type: none"> <li>• <b>Edelstahl</b></li> <li>• inkl. Befestigungsschrauben</li> </ul>	<b>BRAKE DISC</b> <ul style="list-style-type: none"> <li>• <b>stainless steel</b></li> <li>• incl. fixing screws</li> </ul>	 
• <b>360643</b> 50 set	<ul style="list-style-type: none"> <li>• <b>BD-140</b>, 140 mm</li> <li>in M-Wave Verpackung</li> <li>Montageverpackung</li> </ul>	<ul style="list-style-type: none"> <li>• <b>BD-140</b>, 140 mm</li> <li>in M-Wave packaging</li> <li>OEM</li> </ul>	UVP 11,90 €
<b>360634</b> 50 set	<ul style="list-style-type: none"> <li>• <b>BD-160</b>, 160 mm</li> <li>in M-Wave Verpackung</li> </ul>	<ul style="list-style-type: none"> <li>• <b>BD-160</b>, 160 mm</li> <li>in M-Wave packaging</li> </ul>	UVP 11,90 €
• <b>360600</b> 60 set	Montageverpackung	OEM	UVP 11,90 €
<b>360633</b> 50 set	<ul style="list-style-type: none"> <li>• <b>BD-180</b>, 180 mm</li> <li>in M-Wave Verpackung</li> </ul>	<ul style="list-style-type: none"> <li>• <b>BD-180</b>, 180 mm</li> <li>in M-Wave packaging</li> </ul>	UVP 12,90 €
• <b>360606</b> 60 set	Montageverpackung	OEM	UVP 12,90 €
<b>360644</b> 50 set	<ul style="list-style-type: none"> <li>• <b>BD-203</b>, 203 mm</li> <li>in M-Wave Verpackung</li> </ul>	<ul style="list-style-type: none"> <li>• <b>BD-203</b>, 203 mm</li> <li>in M-Wave packaging</li> </ul>	UVP 12,90 €
• <b>360641</b> 60 set	Montageverpackung	OEM	UVP 12,90 €





ART.-NR.	BESCHREIBUNG	DESCRIPTION	
	<b>BREMSBELÄGE</b> <ul style="list-style-type: none"> <li>• <b>Sinterbremsbeläge</b></li> <li>• <b>verschleißarm</b> und <b>hitzebeständig</b></li> <li>• 1 Paar auf <b>Promax</b> Blisterverpackung</li> </ul>	<b>BRAKE PADS</b> <ul style="list-style-type: none"> <li>• <b>sinter brake pads</b></li> <li>• <b>hardwearing</b> and <b>heat-resistant</b></li> <li>• 1 pair on <b>Promax</b> blister packaging</li> </ul>	<div data-bbox="970 235 1153 273" style="border: 1px solid black; padding: 2px;">Tested by the manufacturer based on ISO 4210</div> 
<b>369999</b> 100	<b>POSTER ÜBERSICHT</b> alle Bremsbeläge in <b>Originalgröße</b> abgebildet	<b>POSTER OVERVIEW</b> all brake pads shown in <b>actual size</b>	 <div data-bbox="849 660 936 683" style="text-align: right;">UVP 0,99 €</div>
<b>360590</b>	für <b>Promax DSK 300/310/300R/330R</b> , DC 710/720/913, Render, Render R und <b>Avid BB5</b> , mit Nirosta Ersatz-Clip	für <b>Promax DSK 300/310/300R/330R</b> , DC 710/720/913, Render, Render R und <b>Avid BB5</b> , with stainless steel replacement clip	
<b>360583</b>	für Avid BB7, Juicy 5/7, Promax DC 905/907/908, mit Nirosta Ersatz-Clip	for Avid BB7, Juicy 5/7, Promax DC 905/907/908, with stainless steel replacement clip	
<b>360567</b>	für Promax DC 400 / 610 / 610J	for Promax DC 400 / 610 / 610J	
<b>360580</b> 200/20 pair	für Promax DC320 und DC700	for Promax DC320 and DC700	 <div data-bbox="837 1321 936 1344" style="text-align: right;">UVP 11,90 €</div>
<b>360587</b>	für <b>Shimano XTR (BR-M 785/885)</b> , mit Nirosta Ersatz-Clip	for <b>Shimano XTR (BR-M 785/885)</b> , with stainless steel replacement pin	 <div data-bbox="837 1489 936 1512" style="text-align: right;">UVP 11,90 €</div>
<b>360579</b>	für Shimano XT, Shimano BR-M765, XTR BR-M 965 + SAINT BR-M800, mit Nirosta Ersatz-Clip	for Shimano XT, Shimano BR-M765, XTR BR-M 965 + SAINT BR-M800, with stainless steel replacement pin	 <div data-bbox="837 1747 936 1769" style="text-align: right;">UVP 11,90 €</div>
<b>360577</b> 200/20 pair	für Shimano: BR-C501, BR-M515, BR-M575, BR-M525, BR-M495, BR-M486, BR-M485, BR-M475, BR-M465, BR-M447, BR-M446, BR-M445, BR-M416, BR-M416A, BR-M415, BR-M395, BR-M375, BR-T675, BR-T615, Tektro: - Auriga Pro, - Auriga E-Comp, - Auriga Comp, - Aquila, - Draco WS, - Dorado, - Orion, - Gemini, - Draco 2, TRP: - HY/RD, - Spyre, - Hywire, - Parabox R, - Parabox 2012, mit Nirosta Ersatz-Clip	for Shimano: BR-C501, BR-M515, BR-M575, BR-M525, BR-M495, BR-M486, BR-M485, BR-M475, BR-M465, BR-M447, BR-M446, BR-M445, BR-M416, BR-M416A, BR-M415, BR-M395, BR-M375, BR-T675, BR-T615, Tektro: - Auriga Pro, - Auriga E-Comp, - Auriga Comp, - Aquila, - Draco WS, - Dorado, - Orion, - Gemini, - Draco 2, TRP: - HY/RD, - Spyre, - Hywire, - Parabox R, - Parabox 2012, with stainless steel replacement pin	 <div data-bbox="837 2116 936 2139" style="text-align: right;">UVP 11,90 €</div>

ART.-NR. 	BESCHREIBUNG	DESCRIPTION	
<b>360573</b>	<b>BREMSBELÄGE</b>  für <b>Hayes</b> MX 2 / 3 / 4	<b>BRAKE PADS</b>  for <b>Hayes</b> MX 2 / 3 / 4  UVP 11,90 €	Tested by the manufacturer based on ISO 4210  
<b>360575</b>	für <b>Tektro</b> IO	for <b>Tektro</b> IO	
<b>360578</b> 200/20 pair	für <b>Avid</b> XX / XO Elixir, mit Nirosta Ersatz-Clip	for <b>Avid</b> XX / XO Elixir, with stainless steel replacement pin	
<b>BREMSBELÄGE ›BPD‹</b> <ul style="list-style-type: none"> <li>• <b>Bremskraft gut dosierbar, Hitze isolierend</b> und leiser</li> <li>• 1 Paar in M-Wave Blisterverpackung</li> </ul> Mit Hilfe der <b>1:1 Abbildungen</b> finden Sie schnell und einfach die richtigen Beläge.		<b>BRAKE PADS ›BPD‹</b> <ul style="list-style-type: none"> <li>• <b>precisely controlled braking power, heat insulating</b> and quieter</li> <li>• 1 pair in M-Wave blister packaging</li> </ul> With the help of <b>1:1 figures</b> , you find fast and easily the right pads.	
			Tested by the manufacturer based on ISO 4210 <b>1:1 FIGURE</b>
<b>SHIMANO</b>			
<b>360744</b>	für <b>Shimano</b> XTR: BR-M9000/20, BR-M987/5, XT: BR-M785, SLX: BR-M675/66, Deore: BR-M615, Alfine: BR-S700, Rennrad: BR-R785, BR-RS785, mit Nirosta Ersatz-Clip	for <b>Shimano</b> XTR: BR-M9000/20, BR-M987/5, XT: BR-M785, SLX: BR-M675/66, Deore: BR-M615, Alfine: BR-S700, racing: BR-R785, BR-RS785, with stainless steel replacement clip	
<b>360762</b> 200/10 pair	›BPD Organic S1‹, organisch	›BPD Organic S1‹, organic	
<b>360757</b> 200/10 pair	›BPD Metal S1‹, gesintert	›BPD Metal S1‹, sintered	
<b>NEW</b>			

ART.-NR.	BESCHREIBUNG	DESCRIPTION		
<b>SHIMANO</b>				
<p><b>360746</b></p> <p><b>360764</b></p> <p>200/10 pair</p> <p><b>NEW</b></p>	<p>für <b>Shimano</b> BR-C501, BR-M575, BR-M525, BR-M495, BR-M486, BR-M485, BR-M475, BR-M465, BR-M447, BR-M446, BR-M445, BR-M416, BR-M416A, BR-M415, BR-M395, BR-M375, BR-T675, BR-T615, ..., für <b>Tektro</b> Auriga Pro, Auriga E-Comp, Auriga Comp, Aquila, Draco WS, Dorado, Orion, Gemini, Draco 2, TRP HY/RD, Spyre, Hywire, Parabox R, Parabox 2012 ..., für <b>Promax</b> DSK-909, für <b>Flatmount</b> (Art. 360411), mit Nirosta Ersatz-Clip</p> <p>›BPD Organic STP1‹, organisch</p> <p>›BPD Metal STP1‹, gesintert</p>	<p>for <b>Shimano</b> BR-C501, BR-M575, BR-M525, BR-M495, BR-M486, BR-M485, BR-M475, BR-M465, BR-M447, BR-M446, BR-M445, BR-M416, BR-M416A, BR-M415, BR-M395, BR-M375, BR-T675, BR-T615, ..., for <b>Tektro</b> Auriga Pro, Auriga E-Comp, Auriga Comp, Aquila, Draco WS, Dorado, Orion, Gemini, Draco 2, TRP HY/RD, Spyre, Hywire, Parabox R, Parabox 2012 ..., for <b>Promax</b> DSK-909, for <b>flatmount</b> (art. 360411), with stainless steel replacement pin</p> <p>›BPD Organic STP1‹, organic</p> <p>›BPD Metal STP1‹, sintered</p>	 <p>UVP 9,90 €</p> <p>sintered</p>	
<p><b>360745</b></p> <p><b>360763</b></p> <p>100/10 pair</p> <p><b>NEW</b></p>	<p>für <b>Shimano</b> Saint BR-M810/20, ZEE BR-M640, mit Nirosta Ersatz-Clip</p> <p>›BPD Organic S2‹, organisch</p> <p>›BPD Metal S2‹, gesintert</p>	<p>for <b>Shimano</b> Saint BR-M810/20, ZEE BR-M640, with stainless steel replacement pin</p> <p>›BPD Organic S2‹, organic</p> <p>›BPD Metal S2‹, sintered</p>	 <p>UVP 9,90 €</p> <p>sintered</p>	
<b>MAGURA</b>				
Tested by the manufacturer based on ISO 4210				
<p><b>360749</b></p>	<p>für <b>Magura</b> MT Serie MT2/4/6/8</p> <p>›BPD Organic M1‹, organisch</p>	<p>for <b>Magura</b> MT Serie MT2/4/6/8</p> <p>›BPD Organic M1‹, organic</p>	 <p>UVP 9,90 €</p>	
<b>HAYES</b>				
<p><b>360754</b></p> <p>200/10 pair</p>	<p>für <b>Hayes</b> HFX-9, MAG, MX-1, mit Nirosta Ersatzfeder</p> <p>›BPD Organic H2‹, organisch</p>	<p>for <b>Hayes</b> HFX-9, MAG, MX-1, with stainless steel replacement pin</p> <p>›BPD Organic H2‹, organic</p>	 <p>UVP 9,90 €</p>	



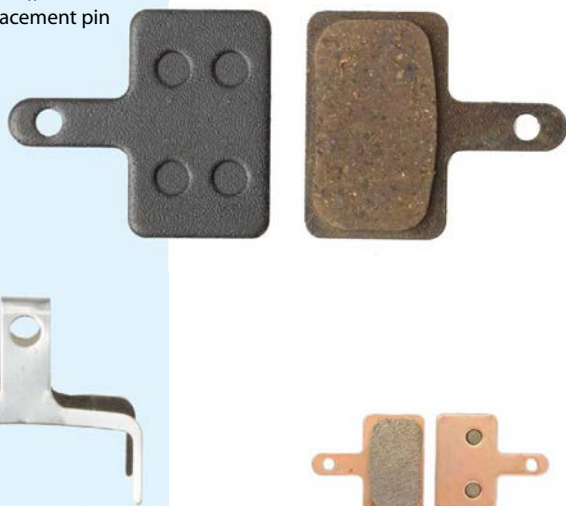
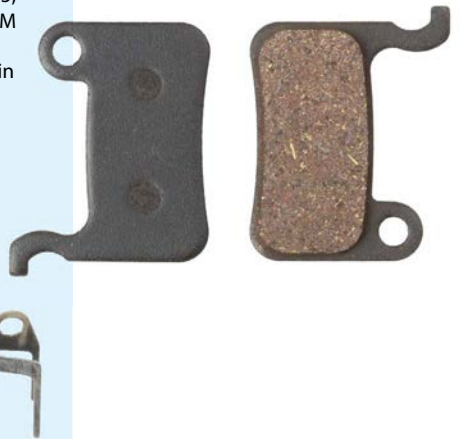

# SCHEIBENBREMSBELÄGE DISC BRAKE PADS

ART.-NR. 	BESCHREIBUNG	DESCRIPTION	
<b>HAYES</b>			
<p><b>360756</b> 100/10 pair</p>	<p>für <b>Hayes</b> MX 2/3/Sole für <b>Promax</b> DSK-810</p> <p>›BPD Organic HP1«, organisch</p>	<p>for <b>Hayes</b> MX 2/3/Sole for <b>Promax</b> DSK-810</p> <p>›BPD Organic HP1«, organic</p> <p>UVP 9,90 €</p>	
<b>TEKTRO</b>			
<p><b>360746</b></p> <p><b>360764</b> 200/10 pair</p> <p><b>NEW</b></p>	<p>für <b>Tektro</b> Auriga Pro, Auriga E-Comp, Auriga Comp, Aquila, Draco WS, Dorado, Orion, Gemini, Draco 2, TRP HY/RD, Spyre, Hywire, Parabox R, Parabox 2012 ..., für <b>Shimano</b> BR-C501, BR-M575, BR-M525, BR-M495, BR-M486, BR-M485, BR-M475, BR-M465, BR-M447, BR-M446, BR-M445, BR-M416, BR-M416A, BR-M415, BR-M395, BR-M375, BR-T675, BR-T615, ..., für <b>Promax</b> DSK-909, für <b>Flatmount</b> (Art. 360411), mit Nirosta Ersatz-Clip</p> <p>›BPD Organic STP1«, organisch</p> <p>›BPD Metal STP1«, gesintert</p>	<p>for <b>Tektro</b> Auriga Pro, Auriga E-Comp, Auriga Comp, Aquila, Draco WS, Dorado, Orion, Gemini, Draco 2, TRP HY/RD, Spyre, Hywire, Parabox R, Parabox 2012 ..., for <b>Shimano</b> BR-C501, BR-M575, BR-M525, BR-M495, BR-M486, BR-M485, BR-M475, BR-M465, BR-M447, BR-M446, BR-M445, BR-M416, BR-M416A, BR-M415, BR-M395, BR-M375, BR-T675, BR-T615, ..., for <b>Promax</b> DSK-909, for <b>flatmount</b> (art. 360411), with stainless steel replacement pin</p> <p>›BPD Organic STP1«, organic</p> <p>›BPD Metal STP1«, sintered</p> <p>UVP 9,90 €</p>	
<p><b>360757</b> 200/10 pair</p>	<p>für <b>Tektro</b> TRP Dash, für <b>Shimano</b> XTR: BR-M 965/6/75, XT: BR-M 765, SLX: BR-M605/85, LX: BR-M 585/95, Deore: BR-M 535, Saint: BR-M 800, T665, Hone: BR-M 601, mit Nirosta Ersatz-Clip</p> <p>›BPD Organic ST1«, organisch</p>	<p>for <b>Tektro</b> TRP Dash, for <b>Shimano</b> XTR: BR-M 965/6/75, XT: BR-M 765, SLX: BR-M605/85, LX: BR-M 585/95, Deore: BR-M 535, Saint: BR-M 800, T665, Hone: BR-M 601, with stainless steel replacement pin</p> <p>›BPD Organic ST1«, organic</p> <p>UVP 9,90 €</p>	





# SCHEIBENBREMSBELÄGE DISC BRAKE PADS

ART.-NR. 	BESCHREIBUNG	DESCRIPTION	
<b>SRAM/AVID</b>			Tested by the manufacturer based on ISO 4210
<b>360741</b> 200/10 pair	für <b>Sram X0 Trail/Guide</b> , mit Nirosta Ersatz-Clip  ›BPD Organic S3‹, organisch	for <b>Sram X0 Trail/Guide</b> , with stainless steel replacement clip  ›BPD Organic S3‹, organic  	  UVP 9,90 €
<b>NEW</b>  <b>360758</b> 200/10 pair	für <b>Sram Red</b> , SRAM RED 22 B1, FORCE 22/CX1 RIVAL 22 700 B1 HRD/HRR,  ›BPD Organic SR1‹, organisch	for <b>Sram Red</b> , SRAM RED 22 B1, FORCE 22/CX1 RIVAL 22 700 B1 HRD/HRR,  ›BPD Organic SR1‹, organic	  UVP 9,90 €













ART.-NR.	BESCHREIBUNG	DESCRIPTION
<ul style="list-style-type: none"> <li>• <b>361490</b> weiß</li> <li>• <b>361498</b> silber</li> <li>• <b>361497</b> schwarz 50 pair</li> </ul>	<p><b>BREMSEGRIFF</b></p> <ul style="list-style-type: none"> <li>• <b>Aluminium</b></li> <li>• für <b>V- und Cantilever</b>-Bremse</li> <li>• rechts und links</li> <li>• Montageverpackung</li> </ul>	<p><b>BRAKE LEVER</b></p> <ul style="list-style-type: none"> <li>• <b>aluminium</b></li> <li>• for <b>V- and cantilever</b> brake</li> <li>• right and left</li> <li>• OEM</li> </ul> <p style="text-align: right;">UVP 9,90 €</p>
<ul style="list-style-type: none"> <li>• <b>360831</b> weiß</li> <li>• <b>360830</b> silber</li> <li>• <b>360854</b> schwarz 50 set</li> </ul>	<p><b>V-BREMSEKÖRPER</b></p> <ul style="list-style-type: none"> <li>• <b>Aluminium</b></li> <li>• für <b>Vorder- und Hinterrad</b></li> <li>• 110 mm</li> <li>• mit <b>langer Feder</b></li> <li>• Montageverpackung</li> </ul>	<p><b>V-BRAKE ARCH</b></p> <ul style="list-style-type: none"> <li>• <b>aluminium</b></li> <li>• for <b>front and rear</b></li> <li>• 110 mm</li> <li>• with <b>long linear spring</b></li> <li>• OEM</li> </ul> <p style="text-align: right;"> <small>Tested by the manufacturer based on ISO 4210</small>            UVP 13,90 €         </p>
<ul style="list-style-type: none"> <li><b>360841</b> Art. 361490 und 360831</li> <li><b>360840</b> Art. 361498 und 360830</li> <li><b>360859</b> Art. 361497 und 360854 25 set</li> </ul>	<p><b>2 Sets</b> für VR und HR in Promax <b>Bliester-verpackung</b> (Art. 084111), bestehend aus</p>	<p><b>2 sets</b> for front and rear in Promax <b>blister packaging</b> (art. 084111), consisting of</p> <p>art. 361490 and 360831</p> <p>art. 361498 and 360830</p> <p>art. 361497 and 360854</p> <p style="text-align: right;">UVP 25,90 €</p>



ART.-NR. 	BESCHREIBUNG	DESCRIPTION	
<ul style="list-style-type: none"> <li>• <b>360819</b> 50 set</li> </ul>	<p><b>V-BREMSKÖRPER</b></p> <ul style="list-style-type: none"> <li>• <b>Aluminium</b></li> <li>• silber</li> <li>• im Set für <b>Vorder- und Hinterrad</b></li> <li>• 70 mm Bremsschuh</li> <li>• 112 mm</li> <li>• mit <b>langer Feder</b></li> <li>• Montageverpackung</li> </ul>	<p><b>V-BRAKE ARCH</b></p> <ul style="list-style-type: none"> <li>• <b>aluminium</b></li> <li>• silver</li> <li>• set for <b>front and rear</b></li> <li>• 70 mm brake shoe</li> <li>• 112 mm</li> <li>• with <b>long linear spring</b></li> <li>• OEM</li> </ul> <p style="text-align: right;">UVP 7,90 €</p>	
<ul style="list-style-type: none"> <li>• <b>364700</b> 50 set</li> </ul>	<p><b>CANTILEVER-BREMSE</b></p> <ul style="list-style-type: none"> <li>• <b>Aluminium</b></li> <li>• silber</li> <li>• im Set für <b>Vorder- und Hinterrad</b></li> <li>• mit Hülse</li> <li>• mit Verbindungskabel</li> <li>• Montageverpackung</li> </ul>	<p><b>CANTILEVER BRAKE</b></p> <ul style="list-style-type: none"> <li>• <b>aluminium</b></li> <li>• silver</li> <li>• set for <b>front and rear</b></li> <li>• with bushes</li> <li>• with link wire</li> <li>• OEM</li> </ul> <p style="text-align: right;">UVP 9,90 €</p>	<p style="text-align: right;"><b>ALUMINIUM</b></p> 
<ul style="list-style-type: none"> <li>• <b>360817</b> 50 set</li> </ul>	<p><b>RENNRAD-BREMSKÖRPER</b></p> <ul style="list-style-type: none"> <li>• aus <b>kaltgeschmiedetem Aluminium</b></li> <li>• im Set für Vorderrad und Hinterrad</li> <li>• <b>superleicht</b>, nur <b>279 g/Set</b></li> <li>• Einstellbereich 39 - 52 mm</li> <li>• mit <b>Aluminium</b>-Bremsschuhen mit austauschbaren Bremsgummis</li> <li>• Montageverpackung</li> </ul>	<p><b>ROAD BRAKE ARCH</b></p> <ul style="list-style-type: none"> <li>• made of <b>cold forged aluminium</b></li> <li>• set for front and rear</li> <li>• <b>super light</b>, only <b>279 g/set</b></li> <li>• adjustable 39 - 52 mm</li> <li>• with <b>aluminium</b> brake shoes with replaceable brake rubbers</li> <li>• OEM</li> </ul> <p style="text-align: right;">UVP 64,90 €</p>	<p>Tested by the manufacturer based on ISO 4210</p>   
<ul style="list-style-type: none"> <li>• <b>360512</b></li> <li>• <b>360515</b> 50 set</li> </ul>	<p><b>Modell ›ECO‹</b></p> <ul style="list-style-type: none"> <li>• silber</li> <li>• Einstellbereich 38 - 50 mm</li> <li>• schwarz</li> <li>• Einstellbereich 43 - 60 mm</li> </ul>	<p><b>model ›ECO‹</b></p> <ul style="list-style-type: none"> <li>• silver</li> <li>• adjustable 38 - 50 mm</li> <li>• black</li> <li>• adjustable 43 - 60 mm</li> </ul> <p style="text-align: right;">UVP 19,90 €</p> <p style="text-align: right;">UVP 19,90 €</p>	 
<ul style="list-style-type: none"> <li>• <b>360818</b> 25 set</li> </ul>	<p><b>(RENNRAD-) BREMSKÖRPER</b></p> <ul style="list-style-type: none"> <li>• <b>Aluminium</b></li> <li>• im Set für Vorderrad und Hinterrad</li> <li>• Einstellbereich 55 - 73 mm</li> <li>• auch passend für viele <b>Retro</b>-Räder</li> <li>• mit <b>2 Drehpunkten</b></li> <li>• Montageverpackung</li> </ul>	<p><b>(ROAD) BRAKE ARCH</b></p> <ul style="list-style-type: none"> <li>• <b>aluminium</b></li> <li>• set for front and rear</li> <li>• adjustable 55 - 73 mm</li> <li>• also suitable for many <b>retro</b> bikes</li> <li>• with <b>dual pivot</b></li> <li>• OEM</li> </ul> <p style="text-align: right;">UVP 42,90 €</p>	 



ART.-NR.	BESCHREIBUNG	DESCRIPTION	
<p></p> <p><b>360181</b></p> <p><b>360182</b></p> <p>100/20</p>	<p><b>BREMSGRIFF</b></p> <ul style="list-style-type: none"> <li>• mit <b>Feststellknopf</b></li> <li>• für <b>V-</b> (und Cantilever) Bremse</li> <li>• <b>3-4 Finger</b></li> <li>• <b>Aluminium</b></li> <li>• Montageverpackung</li> </ul> <p>rechts</p> <p>links</p>	<p><b>BRAKE LEVER</b></p> <ul style="list-style-type: none"> <li>• with <b>fastening knob</b></li> <li>• for <b>V-</b> (and cantilever) brake</li> <li>• <b>3-4 fingers</b></li> <li>• <b>aluminium</b></li> <li>• OEM</li> </ul> <p>right</p> <p>left</p> <p>UVP 8,90 €</p>	 <p><b>FIX</b></p>
<p><b>360063</b></p> <p><b>360064</b></p> <p>100</p>	<p><b>BREMSGRIFF</b></p> <ul style="list-style-type: none"> <li>• <b>hochwertiges Aluminium</b></li> <li>• <b>4 Finger</b></li> <li>• für <b>V-</b> (und Cantilever) Bremse</li> <li>• mit Einstellschraube und Rückholfeder</li> <li>• Montageverpackung</li> </ul> <p><b>silber</b></p> <p>rechts</p> <p>links</p>	<p><b>BRAKE LEVER</b></p> <ul style="list-style-type: none"> <li>• <b>top quality aluminium</b></li> <li>• <b>4 fingers</b></li> <li>• for <b>V-</b> (and cantilever) brake</li> <li>• with adjusting bolt and return spring</li> <li>• OEM</li> </ul> <p><b>silver</b></p> <p>right</p> <p>left</p> <p>UVP 4,90 €</p>	<p>Tested by the manufacturer based on ISO 4210</p>   <p>ROMAX</p>
<p><b>360065</b></p> <p><b>360066</b></p> <p>100</p>	<p><b>schwarz</b></p> <p>rechts</p> <p>links</p>	<p><b>black</b></p> <p>right</p> <p>left</p> <p>UVP 4,90 €</p>	
<p><b>360101</b> AD</p> <p><b>360169</b> AD 100</p> <p>(Nicht erhältlich in AT, BE, D, FR, GB, IT, NL, USA).</p>	<p><b>BREMSGRIFF</b></p> <ul style="list-style-type: none"> <li>• für <b>V-</b> (und Cantilever) Bremse</li> <li>• <b>3-4 Finger</b></li> <li>• <b>Aluminium</b></li> <li>• mit Einstellschraube und Rückholfeder</li> <li>• Hebel silber</li> <li>• Montageverpackung</li> </ul> <p>rechts, silberne <b>Glocke</b> (auf Anfrage auch ohne Glocke erhältlich)</p> <p>links (auf Anfrage auch mit Glocke erhältlich)</p>	<p><b>BRAKE LEVER</b></p> <ul style="list-style-type: none"> <li>• for <b>V-</b> (and cantilever) brake</li> <li>• <b>3-4 fingers</b></li> <li>• <b>aluminium</b></li> <li>• with adjusting bolt and return spring</li> <li>• silver lever</li> <li>• OEM</li> </ul> <p>right, silver <b>bell</b> (without bell available on request) UVP 5,90 € UVP mAD 8,90 €</p> <p>left (with bell available on request) UVP 3,90 € UVP mAD 5,90 €</p> <p>(Not available in AT, BE, D, FR, GB, IT, NL, USA).</p>	 <p><b>BELL</b></p> 
<p><b>360091</b> AD 100 pair</p>	<p><b>BREMSGRIFF</b></p> <ul style="list-style-type: none"> <li>• für <b>V-</b> (und Cantilever) Bremse</li> <li>• 3-4 Finger</li> <li>• mit Einstellschraube und Rückholfeder</li> <li>• <b>Aluminium</b></li> <li>• Montageverpackung</li> </ul> <p>Hebel silber</p>	<p><b>BRAKE LEVER</b></p> <ul style="list-style-type: none"> <li>• for <b>V-</b> (and cantilever) brake</li> <li>• 3-4 fingers</li> <li>• with adjusting bolt and return spring</li> <li>• <b>aluminium</b></li> <li>• OEM</li> </ul> <p>silver lever</p> <p>UVP 5,90 € UVP mAD 8,90 €</p>	 
<ul style="list-style-type: none"> <li>• <b>361530</b> AD</li> <li>• <b>361532</b> AD 100 pair</li> </ul>	<p>Hebel silber</p> <p>Hebel schwarz</p>	<p>silver lever</p> <p>black lever</p> <p>UVP 5,90 € UVP mAD 8,90 €</p>	

ART.-NR. 	BESCHREIBUNG	DESCRIPTION	
<ul style="list-style-type: none"> <li>• <b>361513</b> AD 100 pair</li> <li>• <b>361516</b> AD 100 pair</li> </ul>	<p><b>BREMSSGRIFF</b></p> <ul style="list-style-type: none"> <li>• für <b>V-</b> (und Cantilever) Bremse</li> <li>• mit Einstellschraube und Rückholfeder</li> <li>• <b>Aluminium/Kunststoff</b></li> <li>• <b>2-4 Finger</b></li> <li>• Montageverpackung</li> </ul> <p>Hebel silber</p> <p>Hebel schwarz</p>	<p><b>BRAKE LEVER</b></p> <ul style="list-style-type: none"> <li>• for <b>V-</b> (and cantilever) brake</li> <li>• with adjusting bolt and return spring</li> <li>• <b>aluminium/plastic</b></li> <li>• <b>2-4 fingers</b></li> <li>• OEM</li> </ul> <p>silver lever</p> <p>black lever</p> <p style="text-align: right;">UVP 4,90 € UVP mAD 6,90 €</p>	
<ul style="list-style-type: none"> <li>• <b>360036</b></li> <li>• <b>360035</b> 100</li> </ul>	<p><b>KINDER-BREMSSGRIFF</b></p> <ul style="list-style-type: none"> <li>• für (12"), <b>16"</b>, <b>20"</b>, (24") Kinderräder</li> <li>• kindgerechte Form</li> <li>• <b>Aluminium</b></li> <li>• für <b>V-</b> (und Cantilever) Bremse</li> <li>• mit Einstellschraube und Rückholfeder</li> <li>• Montageverpackung</li> </ul> <p>rechts</p> <p>links</p>	<p><b>CHILDREN BRAKE LEVER</b></p> <ul style="list-style-type: none"> <li>• for (12"), <b>16"</b>, <b>20"</b>, (24") children bikes</li> <li>• short reach especially for children</li> <li>• <b>aluminium</b></li> <li>• for <b>V-</b> (and cantilever) brake</li> <li>• with adjusting bolt and return spring</li> <li>• OEM</li> </ul> <p>right</p> <p>left</p> <p style="text-align: right;">UVP 3,90 €</p>	<p>Tested by the manufacturer based on ISO 4210</p>
<ul style="list-style-type: none"> <li>• <b>360076</b> AD</li> <li>• <b>360073</b> AD 200</li> </ul>	<p><b>KINDER-BREMSSGRIFF</b></p> <ul style="list-style-type: none"> <li>• kindgerechte Form</li> <li>• <b>Kunststoff</b></li> <li>• für <b>V-</b> (und Cantilever) Bremse</li> <li>• mit Einstellschraube und Rückholfeder</li> <li>• Montageverpackung</li> </ul> <p>rechts</p> <p>links</p>	<p><b>CHILDREN BRAKE LEVER</b></p> <ul style="list-style-type: none"> <li>• short reach especially for children</li> <li>• <b>plastic</b></li> <li>• for <b>V-</b> (and cantilever) brake</li> <li>• with adjusting bolt and return spring</li> <li>• OEM</li> </ul> <p>right</p> <p>left</p> <p style="text-align: right;">UVP 1,90 € UVP mAD 2,90 €</p>	
<ul style="list-style-type: none"> <li>• <b>360074</b> AD</li> <li>• <b>360075</b> AD 200</li> </ul>	<p><b>KINDER-BREMSSGRIFF</b></p> <ul style="list-style-type: none"> <li>• <b>kindgerechte Form</b> bezüglich <b>Sicherheit</b> und Fingerlänge</li> <li>• für Cantilever Bremse</li> <li>• mit Einstellschraube</li> <li>• Klemme Ø 22,2 mm</li> <li>• Montageverpackung</li> </ul> <p>rechts</p> <p>links</p>	<p><b>CHILDREN BRAKE LEVER</b></p> <ul style="list-style-type: none"> <li>• <b>child-friendly shape</b> regarding <b>safety</b> and finger length</li> <li>• for cantilever brake</li> <li>• with adjusting bolt</li> <li>• clamp Ø 22.2 mm</li> <li>• OEM</li> </ul> <p>right</p> <p>left</p> <p style="text-align: right;">UVP 1,90 € UVP mAD 2,76 €</p>	

ART.-NR.	BESCHREIBUNG	DESCRIPTION	
<b>360155</b> 25 pair	<b>ZWEIT-BREMSSGRIFF</b> Diesen Spezial-Bremssgriff können Sie an einer <b>beliebigen Position</b> Ihres (Renn-) Lenkers als <b>Zweit- (Zusatz-) Bremssgriff</b> anbringen. Das Bremskabel wird durch den Hebel zum normalen Bremssgriff geführt. So können Sie z. B. in der <b>Mittelposition</b> beim Rennlenker fahren und trotzdem bremsbereit sein. <ul style="list-style-type: none"> <li>• <b>aufklappbare Klemmung</b> für leichte (De-)Montage</li> <li>• Klemme Ø 31,8 mm (mit Adapter für 23,8 mm)</li> <li>• nur <b>44 g</b>/Stück</li> <li>• Aluminium</li> <li>• im Promax Einzelkarton</li> </ul>	<b>ADDITIONAL BRAKE LEVER</b> This special brake lever you can mount as an <b>additional brake lever</b> on your (racing-)handlebar at almost <b>all positions</b> . Brake cable goes through this special lever to the normal brake lever. Therefore it is e. g. possible to drive in <b>middle-position</b> of racing-handlebar and to be ready for braking. <ul style="list-style-type: none"> <li>• <b>fold-up clamping</b> for easy (dis)mounting</li> <li>• clamp Ø 31.8 mm (with adapter for 23.8 mm)</li> <li>• only <b>44 g</b>/pc</li> <li>• aluminium</li> <li>• in Promax box</li> </ul>	<div style="display: flex; justify-content: space-between;"> <div style="font-size: 8px;">Tested by the manufacturer based on ISO 4210</div> <div style="text-align: right;"> </div> </div> <div style="text-align: right; margin-top: 10px;"> <p><b>44 g</b></p> </div> <div style="text-align: right; margin-top: 10px;"> <div style="border: 1px solid black; padding: 2px; display: inline-block;"><b>SINGLESPEED</b></div> </div> <div style="text-align: center; margin-top: 10px;"> <p style="font-size: 8px;">23,8 - 31,8 mm</p> </div> <div style="display: flex; justify-content: space-around; margin-top: 10px;"> </div> <div style="text-align: right; margin-top: 10px;">UVP 25,90 €</div>
<b>360161 AD</b> 100 pair	<b>ZWEIT-BREMSSGRIFF</b> Diesen Spezial-Bremssgriff können Sie an einer <b>beliebigen Position</b> Ihres (Renn-) Lenkers als <b>Zweit- (Zusatz-) Bremssgriff</b> anbringen. Das Bremskabel wird durch den Hebel zum normalen Bremssgriff geführt. So können Sie z. B. in der <b>Mittelposition</b> beim Rennlenker fahren und trotzdem bremsbereit sein. <ul style="list-style-type: none"> <li>• <b>aufklappbare Klemmung</b> für leichte (De-)Montage</li> <li>• Klemme Ø <b>22,2 mm</b></li> <li>• mit Einstellschraube</li> <li>• aus <b>Aluminium</b></li> <li>• Montageverpackung</li> </ul>	<b>ADDITIONAL BRAKE LEVER</b> This special brake lever you can mount as an <b>additional brake lever</b> on your (racing-)handlebar at almost <b>all positions</b> . Brake cable goes through this special lever to the normal brake lever. Therefore it is e. g. possible to drive in <b>middle-position</b> of racing-handlebar and to be ready for braking. <ul style="list-style-type: none"> <li>• <b>fold-up clamping</b> for easy (dis)mounting</li> <li>• clamp Ø <b>22.2 mm</b></li> <li>• with adjustment screw</li> <li>• made of <b>aluminium</b></li> <li>• OEM</li> </ul>	<div style="text-align: center; margin-top: 10px;"> <p style="font-size: 8px;">22,2 mm</p> </div> <div style="text-align: right; margin-top: 10px;">           UVP 11,90 €            UVP mAD 17,90 €         </div>
<b>360346</b> 50 pair	<b>BREMSSGRIFF</b> <ul style="list-style-type: none"> <li>• zur Anbringung am <b>Lenkerende</b></li> <li>• z. B. für Zeitfahren, Single Speed, ...</li> <li>• <b>interne Zugverlegung</b></li> <li>• <b>ergonomisches</b> Griffdesign</li> <li>• aus Aluminium</li> <li>• für Lenkerinnen-Ø 20,8 - 21,8 mm</li> <li>• nur <b>79 g</b>/Stück</li> <li>• Montageverpackung</li> </ul>	<b>BRAKE LEVER</b> <ul style="list-style-type: none"> <li>• can be mounted on the <b>handlebar end</b></li> <li>• e. g. for time trial, single speed, ...</li> <li>• <b>internal cable routing</b></li> <li>• <b>ergonomic</b> grip design</li> <li>• made of aluminium</li> <li>• for handlebar with inner Ø 20.8 - 21.8 mm</li> <li>• only <b>79 g</b>/pc</li> <li>• OEM</li> </ul>	<div style="display: flex; justify-content: space-between;"> <div style="font-size: 8px;">Tested by the manufacturer based on ISO 4210</div> </div> <div style="text-align: center; margin-top: 10px;"> </div> <div style="text-align: center; margin-top: 10px;"> </div> <div style="text-align: right; margin-top: 10px;">UVP 25,90 €</div>
<b>361443</b> 50 pair	<b>AERO-BREMSSGRIFF</b> <ul style="list-style-type: none"> <li>• <b>Aluminium</b></li> <li>• mit <b>zwei Griffreichweitenpositionen</b> für große und kleine Hände</li> <li>• mit Rückholfeder</li> <li>• mit Handauflage</li> <li>• Montageverpackung</li> </ul>	<b>AERO BRAKE LEVER</b> <ul style="list-style-type: none"> <li>• <b>aluminium</b></li> <li>• with <b>two grip reach positions</b> for big and small hands</li> <li>• with return spring</li> <li>• with rubber cover</li> <li>• OEM</li> </ul>	<div style="display: flex; justify-content: space-between;"> <div style="font-size: 8px;">Tested by the manufacturer based on ISO 4210</div> </div> <div style="text-align: center; margin-top: 10px;"> </div> <div style="display: flex; justify-content: space-around; margin-top: 10px;"> <div style="font-size: 8px;">Pos. 1</div> <div style="font-size: 8px;">Pos. 2</div> </div> <div style="text-align: right; margin-top: 10px;">UVP 22,90 €</div>

ART.-NR. 	BESCHREIBUNG	DESCRIPTION	
<b>361740</b> 200/20 pair	<b>CARTRIDGE-/V-BREMSSCHUHE</b> <ul style="list-style-type: none"> <li>Aluminium-Bremsschuh mit <b>austauschbaren</b> Bremsgummis</li> <li>silber</li> <li>für V-Bremse</li> <li>paarweise in Promax <b>Eurolochbox</b>, 20 Paar im <b>Thekendisplay</b></li> </ul>	<b>CARTRIDGE/V-BRAKE SHOES</b> <ul style="list-style-type: none"> <li>aluminium brake shoe with <b>replaceable</b> brake rubbers</li> <li>silver</li> <li>for V-brake</li> <li>1 pair in Promax <b>eurohole box</b>, 20 pairs in <b>sales display</b></li> </ul>	Tested by the manufacturer based on ISO 4210    UVP 9,90 €
<b>361741</b> 500 pair	Ersatzgummi mit <b>Nirosta</b> -Ersatzstift <ul style="list-style-type: none"> <li>passend für Art. 361740, ...</li> <li>paarweise im Polybeutel</li> </ul>	replacement rubber with <b>stainless</b> pin <ul style="list-style-type: none"> <li>suitable for art. 361740, ...</li> <li>1 pair in PE bag</li> </ul>	 UVP 2,90 €
<b>361742</b> 100/10 pair	<b>CARTRIDGE V-BREMSSCHUHE</b> <b>›BPR-VC-BASE-ALU‹</b> <ul style="list-style-type: none"> <li>Aluminium-Bremsschuhe mit <b>austauschbaren</b> Bremsgummis</li> <li>Länge: 72 mm</li> <li>für V-Bremsen</li> <li>für trockene und nasse Verhältnisse</li> <li>für alle Stahl- und Aluminiumfelgen</li> <li>paarweise auf M-Wave Eurolochkarte</li> </ul>	<b>CARTRIDGE V-BRAKE SHOES</b> <b>›BPR-VC-BASE-ALU‹</b> <ul style="list-style-type: none"> <li>aluminium brake shoes with <b>replaceable</b> brake rubbers</li> <li>length: 72 mm</li> <li>for V-brakes</li> <li>for dry and wet conditions</li> <li>for all steel- and aluminium rims</li> <li>1 pair on M-Wave eurohole card</li> </ul>	Tested by the manufacturer based on ISO 4210    UVP 8,90 €
<b>361771</b> 100 pair	<b>BREMSSCHUH-ERSATZBELAG</b> <b>›BPR-INSERT-VC‹</b> <ul style="list-style-type: none"> <li>passend für Art. 361742, ...</li> <li>mit <b>Nirosta</b>-Stift</li> <li>paarweise auf M-Wave Eurolochkarte</li> </ul>	<b>BRAKE SHOE REPLACEMENT RUBBER</b> <b>›BPR-INSERT-VC‹</b> <ul style="list-style-type: none"> <li>suitable for art. 361742, ...</li> <li>with <b>stainless</b> pin</li> <li>1 pair on M-Wave eurohole card</li> </ul>	  UVP 2,90 €
<b>361070</b> 200/20 pair	<b>CARTRIDGE-/V-BREMSSCHUHE</b> <ul style="list-style-type: none"> <li>Aluminium-Bremsschuhe mit <b>austauschbaren</b>, 3-farbigen Bremsgummis</li> <li><b>3 Farben = 3 Funktionen durch 3 Profile:</b></li> <li><b>Olivgrün</b> = hohe Bremskraft bei nassen Verhältnissen</li> <li><b>Schwarz</b> = hohe Allroundbremsleistung</li> <li><b>Braun</b> = geringe Geräusentwicklung</li> <li>paarweise in Promax <b>Eurolochbox</b>, 20 Paar im <b>Thekendisplay</b></li> </ul>	<b>CARTRIDGE/V-BRAKE SHOES</b> <ul style="list-style-type: none"> <li>aluminium brake shoes with <b>replaceable</b>, 3-coloured brake rubbers</li> <li><b>3 colours = 3 functions through 3 profiles:</b></li> <li><b>Green</b> = great stopping power under wet conditions</li> <li><b>Black</b> = high all-round brake performance</li> <li><b>Brown</b> = low noise</li> <li>1 pair in Promax <b>eurohole box</b>, 20 pairs in <b>sales display</b></li> </ul>	Tested by the manufacturer based on ISO 4210    UVP 9,90 €
<b>361072</b> 200/20 pair	Ersatzgummi mit <b>Nirosta</b> -Ersatzstift paarweise in Promax <b>Blisterverpackung</b>	replacement rubber with <b>stainless</b> pin 1 pair in Promax <b>blister packaging</b>	 
<b>361071</b> 500 pair	paarweise im Polybeutel	1 pair in PE bag	 UVP 4,90 €



ART.-NR.	BESCHREIBUNG	DESCRIPTION	
<p><b>361631</b> 200/20 pair</p>	<p><b>V-BREMSSCHUHE</b></p> <ul style="list-style-type: none"> <li>mit <b>3-farbigen</b> Bremsgummis</li> <li>70 mm</li> <li><b>3 Farben = 3 Funktionen durch 3 Profile:</b></li> <li><b>Olivgrün</b> = hohe Bremskraft bei nassen Verhältnissen</li> <li><b>Schwarz</b> = hohe Allroundbremsleistung</li> <li><b>Braun</b> = geringe Geräusentwicklung</li> <li>paarweise in Promax <b>Eurolochbox</b>, 20 Paar im <b>Thekendisplay</b></li> </ul>	<p><b>V-BRAKE SHOES</b></p> <ul style="list-style-type: none"> <li>with <b>3-coloured</b> brake rubbers</li> <li>70 mm</li> <li><b>3 colours = 3 functions through 3 profiles:</b></li> <li><b>Green</b> = great stopping power under wet conditions</li> <li><b>Black</b> = high all-round brake performance</li> <li><b>Brown</b> = low noise</li> <li>1 pair in Promax <b>eurohole box</b>, 20 pairs in <b>sales display</b></li> </ul>	<p>Tested by the manufacturer based on ISO 4210</p>  <p>UVP 4,90 €</p>
<p><b>361021</b> 100/10 pair</p>	<p><b>V-BREMSSCHUHE</b> ›BPR-VC-DUAL‹</p> <ul style="list-style-type: none"> <li>mit <b>2-farbigen</b> Bremsgummis:</li> <li><b>2 Farben = 2 Funktionen durch 2 Profile:</b></li> <li><b>schwarz</b> = starke Bremswirkung</li> <li><b>rot</b> = Wasserverdrängung</li> <li>Länge: 72 mm</li> <li>für V-Bremsen</li> <li>für trockene und nasse Verhältnisse</li> <li>für alle Stahl- und Aluminiumfelgen</li> <li>Bolzen mit Gewinde und Befestigungsmaterial</li> <li>paarweise auf M-Wave Eurolochkarte</li> </ul>	<p><b>V-BRAKE SHOES</b> ›BPR-VC-DUAL‹</p> <ul style="list-style-type: none"> <li>with <b>2 coloured</b> brake shoes</li> <li><b>2 colours = 2 functions through 2 profiles:</b></li> <li><b>black</b> = extra grip</li> <li><b>red</b> = water displacement</li> <li>length: 72 mm</li> <li>for V-brakes</li> <li>for dry and wet conditions</li> <li>for all steel- and aluminium rims</li> <li>bolt with thread and mounting material</li> <li>1 pair on M-Wave eurohole card</li> </ul>	 <p>UVP 4,90 €</p>
<p><b>361765</b> 200/20 pair</p>	<p><b>V-BREMSSCHUHE</b></p> <ul style="list-style-type: none"> <li>70 mm</li> <li>symmetrisch</li> <li>schwarz/<b>gelb</b></li> <li>mit Bolzen, Gewinde und Befestigungsmaterial</li> <li>paarweise in Promax <b>Eurolochbox</b>, 20 Paar im <b>Thekendisplay</b></li> </ul>	<p><b>V-BRAKE SHOES</b></p> <ul style="list-style-type: none"> <li>70 mm</li> <li>symmetric</li> <li>black/<b>yellow</b></li> <li>with bolt, thread and fixing parts</li> <li>1 pair in Promax <b>eurohole box</b>, 20 pairs in <b>sales display</b></li> </ul>	<p>Tested by the manufacturer based on ISO 4210</p>  <p>UVP 3,90 €</p>
<p><b>361768</b> 200/20 pair</p>	<p><b>V-BREMSSCHUHE</b></p> <ul style="list-style-type: none"> <li>mit <b>schwarzen</b> Bremsgummis</li> <li>70 mm</li> <li>paarweise in Promax <b>Eurolochbox</b>, 20 Paar im <b>Thekendisplay</b></li> </ul>	<p><b>V-BRAKE SHOES</b></p> <ul style="list-style-type: none"> <li>with <b>black</b> brake rubbers</li> <li>70 mm</li> <li>1 pair in Promax <b>eurohole box</b>, 20 pairs in <b>sales display</b></li> </ul>	<p>Tested by the manufacturer based on ISO 4210</p>  <p>UVP 3,90 €</p>
<p><b>361766</b> 100/10 set</p>	<p><b>2 Paar in Promax Eurolochbox</b></p>	<p><b>2 pairs in Promax eurohole box</b></p>	 <p>UVP 5,90 €</p>

ART.-NR. 	BESCHREIBUNG	DESCRIPTION	
<b>361020</b> 100/10 pair	<b>V-BREMSSCHUHE</b> <b>›BPR-VC-BASE‹</b> <ul style="list-style-type: none"> <li>• Länge: 72 mm</li> <li>• für V-Bremsen</li> <li>• für trockene und nasse Verhältnisse</li> <li>• für alle Stahl- und Aluminiumfelgen</li> <li>• Bolzen mit Gewinde und Befestigungsmaterial</li> <li>• paarweise auf M-Wave Eurolochkarte</li> </ul>	<b>V-BRAKE SHOES</b> <b>›BPR-VC-BASE‹</b> <ul style="list-style-type: none"> <li>• length: 72 mm</li> <li>• for V-brakes</li> <li>• for dry and wet conditions</li> <li>• for all steel- and aluminium rims</li> <li>• bolt with thread and mounting material</li> <li>• 1 pair on M-Wave eurohole card</li> </ul>	<div style="border: 1px solid black; padding: 2px; font-size: 8px;">Tested by the manufacturer based on ISO 4210</div>  
<b>361024</b> 1 set	25 Paar in Werkstatt-Verpackung	25 pair in workshop-packaging	
<b>NEW</b>  <b>361622</b> 120/10 set	<b>V-BREMSSCHUHE</b> 70 mm symmetrisch, <b>2 Paar</b> auf M-Wave Eurolochkarte	<b>V-BRAKE SHOES</b> 70 mm symmetric, <b>2 pairs</b> on M-Wave eurohole card	 
<b>361720</b> 300/100 pair	asymmetrisch, paarweise im Polybeutel	asymmetric, 1 pair in PE bag	
<b>361027</b> 250/25 pair	72 mm asymmetrisch, paarweise in Polybeutel, mit Barcodeaufkleber	72 mm asymmetric, 1 pair in PE bag, with barcode sticker	
<b>361767</b> 200/20 pair	<b>V-BREMSSCHUHE</b> <ul style="list-style-type: none"> <li>• 70 mm</li> <li>• Bolzen ohne Gewinde</li> <li>• paarweise in Promax Eurolochbox, 20 Paar im Thekendisplay</li> </ul>	<b>V-BRAKE SHOES</b> <ul style="list-style-type: none"> <li>• 70 mm</li> <li>• bolt without thread</li> <li>• 1 pair in Promax eurohole box, 20 pairs in sales display</li> </ul>	<div style="border: 1px solid black; padding: 2px; font-size: 8px;">Tested by the manufacturer based on ISO 4210</div>  
<b>361022</b> 100/10 pair  <b>361023</b> 300	<b>V-BREMSSCHUHE</b> <b>›BPR-VC-NT‹</b> <ul style="list-style-type: none"> <li>• Länge: 72 mm</li> <li>• für trockene und nasse Verhältnisse</li> <li>• für alle Stahl- und Aluminiumfelgen</li> <li>• Bolzen ohne Gewinde</li> </ul>	<b>V BRAKE SHOES</b> <b>›BPR-VC-NT‹</b> <ul style="list-style-type: none"> <li>• length: 72 mm</li> <li>• for dry and wet conditions</li> <li>• for all steel- and aluminium rims</li> <li>• bolt without thread</li> </ul>	<div style="border: 1px solid black; padding: 2px; font-size: 8px;">Tested by the manufacturer based on ISO 4210</div>  

ART.-NR. 	BESCHREIBUNG	DESCRIPTION	
<b>361769</b> 160/16 pair	<b>CANTILEVER-BREMSSCHUHE</b> <ul style="list-style-type: none"> <li>• 70 mm</li> <li>• asymmetrisch</li> <li>• für <b>Aluminium-</b> und <b>Stahlfelgen</b></li> <li>• paarweise in Promax <b>Eurolochbox</b>, 16 Paar im <b>Thekendisplay</b></li> </ul>	<b>CANTILEVER BRAKE SHOES</b> <ul style="list-style-type: none"> <li>• 70 mm</li> <li>• asymmetric</li> <li>• for <b>aluminium</b> and <b>steel</b> rims</li> <li>• 1 pair in Promax <b>eurohole box</b>, 16 pairs in <b>sales display</b></li> </ul>	<div style="display: flex; justify-content: space-between;"> <div data-bbox="965 235 1149 273" style="border: 1px solid blue; padding: 2px;">             Tested by the manufacturer based on ISO 4210           </div> <div data-bbox="1209 230 1340 250">  </div> </div>  <p style="text-align: right;">UVP 3,90 €</p>
<b>361082</b> 100/10 set	<b>CANTILEVER-BREMSSCHUHE</b> <ul style="list-style-type: none"> <li>• 70 mm</li> <li>• asymmetrisch</li> <li>• Bolzen ohne Gewinde</li> <li>• für <b>Aluminium-</b> und <b>Stahlfelgen</b></li> <li>• <b>1 Set = 2 Paar</b> im Polybeutel</li> </ul>	<b>CANTILEVER BRAKE SHOES</b> <ul style="list-style-type: none"> <li>• 70 mm</li> <li>• asymmetric</li> <li>• bolt without thread</li> <li>• for <b>aluminium</b> and <b>steel</b> rims</li> <li>• <b>1 Set = 2 pair</b> in PE bag</li> </ul>	 <p style="text-align: right;">UVP 4,90 €</p>
<b>361752</b> 500/50	<b>CANTILEVER-BREMSSCHUHE</b> <ul style="list-style-type: none"> <li>• für <b>Aluminium-</b> und <b>Stahlfelgen</b></li> <li>• 55 mm</li> </ul>	<b>CANTILEVER BRAKE SHOES</b> <ul style="list-style-type: none"> <li>• for <b>aluminium</b> and <b>steel</b> rims</li> <li>• 55 mm</li> </ul>	 <p style="text-align: right;">UVP 0,90 €</p>
<b>361753</b> 500/100	wie Art. 361752, aber vom Hersteller geprüft angelehnt an ISO 4210	like art. 361752, but tested by the manufacturer based on ISO 4210	<div style="display: flex; justify-content: space-between;"> <div data-bbox="965 1243 1149 1281" style="border: 1px solid blue; padding: 2px;">             Tested by the manufacturer based on ISO 4210           </div> <div data-bbox="1209 1444 1340 1464">  </div> </div>  <p style="text-align: right;">UVP 1,50 €</p>
<b>361790</b> 200 pair	<b>BREMSSCHUHE FÜR HYDRAULISCHE FELGENBREMSEN</b> <ul style="list-style-type: none"> <li>• z. B. für <b>Magura</b> HS11, HS22, HS33R, HS33R Trial, HS33 R FIRMtech (kein original Magura Ersatzteil)</li> <li>• 50 mm</li> </ul> <ul style="list-style-type: none"> <li>• für <b>Aluminiumfelgen</b></li> <li>• paarweise im <b>Polybeutel mit Promax Eurolochheader</b></li> </ul>	<b>BRAKE SHOES FOR HYDRAULIC RIM BRAKES</b> <ul style="list-style-type: none"> <li>• e. g. <b>Magura</b> HS11, HS22, HS33R, HS33R Trial, HS33 R FIRMtech (no original Magura spare part)</li> <li>• 50 mm</li> </ul> <ul style="list-style-type: none"> <li>• for <b>aluminium</b> rim</li> <li>• 1 pair in <b>PE bag with Promax eurohole header</b></li> </ul>	<div style="display: flex; justify-content: space-between;"> <div data-bbox="965 1444 1149 1482" style="border: 1px solid blue; padding: 2px;">             Tested by the manufacturer based on ISO 4210           </div> <div data-bbox="1209 1444 1340 1464">  </div> </div>  <p style="text-align: right;">UVP 6,90 €</p>
<b>361792</b> 500/10 pair	<b>BREMSSCHUHE FÜR HYDRAULISCHE FELGENBREMSEN ›BPR-HY‹</b> <ul style="list-style-type: none"> <li>• für <b>Aluminium-</b> und <b>Stahlfelgen</b></li> <li>• z. B. für <b>Magura</b> HS11, HS22, HS33R, HS33R Trial, HS33 R FIRMtech (kein original Magura Ersatzteil)</li> <li>• 50 mm</li> <li>• paarweise im <b>Polybeutel</b></li> </ul>	<b>BRAKE SHOES FOR HYDRAULIC RIM BRAKES ›BPR-HY‹</b> <ul style="list-style-type: none"> <li>• for <b>aluminium</b> and <b>steel</b> rims</li> <li>• e. g. <b>Magura</b> HS11, HS22, HS33R, HS33R Trial, HS33 R FIRMtech (no original Magura spare part)</li> <li>• 50 mm</li> <li>• 1 pair in <b>PE bag</b></li> </ul>	<div style="display: flex; justify-content: space-between;"> <div data-bbox="965 1825 1149 1863" style="border: 1px solid blue; padding: 2px;">             Tested by the manufacturer based on ISO 4210           </div> <div data-bbox="1241 1825 1340 1886">  </div> </div>  <p style="text-align: right;">UVP 5,90 €</p>





ART.-NR.	BESCHREIBUNG	DESCRIPTION	
<b>361734</b> 500/100	<b>BREMSSCHUHE</b> <ul style="list-style-type: none"> <li>mit <b>Hutmutter</b></li> <li>für <b>Aluminium-</b> und Stahlfelgen</li> <li>40 mm</li> <li>100 St. im Polybeutel</li> </ul>	<b>BRAKE SHOES</b> <ul style="list-style-type: none"> <li>with <b>closed nut</b></li> <li>for <b>aluminium</b> and steel rims</li> <li>40 mm</li> <li>100 pcs in PE bag</li> </ul>	<div style="border: 1px solid black; padding: 2px; font-size: 8px;">Tested by the manufacturer based on ISO 4210</div>  <p style="text-align: right;">UVP 64,90 €/100</p>
<b>361733</b> 1.000/100	<b>BREMSSCHUHE</b> <ul style="list-style-type: none"> <li>mit <b>Hutmutter</b></li> <li>40 mm</li> <li>100 St. im Polybeutel</li> </ul>	<b>BRAKE SHOES</b> <ul style="list-style-type: none"> <li>with <b>closed nut</b></li> <li>40 mm</li> <li>100 pcs in PE bag</li> </ul>	 <p style="text-align: right;">UVP 27,90 €/100</p>
BREMSENTEILE		BRAKE PARTS	
<b>360904</b> 200	<b>KABELFÜHRUNG</b> <ul style="list-style-type: none"> <li><b>Aluminium</b></li> <li>schwarz</li> <li>mit Bolzen und Distanzhülsen</li> <li>passend für Art. 640020/5</li> </ul>	<b>POWER HANGER</b> <ul style="list-style-type: none"> <li><b>aluminium</b></li> <li>black</li> <li>with bolt and spacers</li> <li>suitable for art. 640020/5</li> </ul>	 <p style="text-align: right;">UVP 5,90 €</p>
<b>361710</b> 500/10	<b>VERBINDUNGSKABEL</b> <ul style="list-style-type: none"> <li>für Cantilever-Bremse</li> <li>Nippel 7 x 6 mm</li> <li>93 mm lang</li> </ul>	<b>LINK WIRE</b> <ul style="list-style-type: none"> <li>for cantilever brake</li> <li>nipple 7 x 6 mm</li> <li>93 mm long</li> </ul>	 <p style="text-align: right;">UVP 0,90 €</p>
<b>361784</b> 1.500/100	<b>KABELBRÜCKE</b> <ul style="list-style-type: none"> <li>Stahl</li> <li>komplett mit Schraube und Mutter</li> </ul>	<b>CABLE BRIDGE</b> <ul style="list-style-type: none"> <li>steel</li> <li>with screw and nut</li> </ul>	 <p style="text-align: right;">UVP 0,90 €</p>
<b>361850</b> 72 can	<b>FALTENBALG</b> <ul style="list-style-type: none"> <li>für V-Bremsszug</li> <li>schwarz</li> <li>25 Stück in Promax Dose</li> </ul>	<b>RUBBER DUST COVER</b> <ul style="list-style-type: none"> <li>for V-brake cable</li> <li>black</li> <li>25 pcs in Promax can</li> </ul>	 <p style="text-align: right;">UVP 4,90 € / can</p>
<b>360829</b> 5.000/500/100	<b>KABELFÜHRUNG</b> <ul style="list-style-type: none"> <li>flexible Kabelführung für V-Bremse</li> <li>0 - 180 Grad</li> </ul>	<b>FLEXI PIPE</b> <ul style="list-style-type: none"> <li>flexible cable pipe for V-brake</li> <li>0 - 180 degrees</li> </ul>	 <p style="text-align: right;">UVP 1,90 €</p>
<b>360839</b> 1.000/100	wie Art. 360829, aber <b>Nirosta</b> mit <b>Bremskraft-Begrenzer</b>	like art. 360829, but <b>stainless steel</b> with <b>power adjuster</b>	 <p style="text-align: right;">UVP 2,90 €</p>
<b>362912</b> 2.500/100	<b>KABELKLEMMSCHRAUBE</b> <ul style="list-style-type: none"> <li>z. B. für Felgenbremsen</li> </ul>	<b>CABLE ANCHOR BOLT</b> <ul style="list-style-type: none"> <li>e. g. for caliper brakes</li> </ul>	 <p style="text-align: right;">UVP 0,50 €</p>

ART.-NR.	BESCHREIBUNG	DESCRIPTION	
<b>374241</b> 15 set	<b>AUSSENHÜLLEN-ENDHÜLSEN</b> • für <b>Schaltaußenhüllen</b> • 4 mm  <b>›CAPGO OL‹</b> • <b>gedichtet</b> • aus <b>Aluminium</b> • 15 Stk. in capgo Verpackung	<b>OUTER HOUSING END CAPS</b> • for <b>shift cables</b> • 4 mm  <b>›CAPGO OL‹</b> • <b>sealed</b> • made of <b>aluminium</b> • 15 pcs. in capgo packaging	
			UVP 9,90 €
<b>374244</b> 900/50	<b>AUSSENHÜLLEN-ENDHÜLSEN</b> <b>›CAPGO OL‹</b> • für <b>Bremsaußenhüllen</b> • 5 mm • aus <b>Aluminium</b> • 50 Stk. in Montageverpackung	<b>OUTER HOUSING END CAPS</b> <b>›CAPGO OL‹</b> • for <b>brake cables</b> • 5 mm • made of <b>aluminium</b> • 50 pcs. in OEM packaging	
			UVP 0,98 €
<b>374257</b> 10 <b>NEW</b>	<b>SPIRALSCHLAUCH</b> • saubere und einfache Anwendung • <b>100 m auf Spule</b> • Außen-Ø 6 mm • Innen-Ø 4,8 mm • Montageverpackung	<b>SPIRAL COILED TUBE</b> • clean and simple application • <b>100 m on spool</b> • outer-Ø 6 mm • inner-Ø 4.8 mm • OEM	
			UVP 99,90 €



www.kmc-messingschlager.com

www.kmc-messingschlager.com



100 % sind uns zu wenig.



**eCargo1** – die Schwerlastkette für höchste Ansprüche. Mit einer Zugfestigkeit von 1.350 Nm liegt die **eCargo1** bei 150 % des geforderten Standards. So trotzt die Kette den enormen Kräften, die durch hohe Motorendrehmomente und schwere Lasten am Antriebsstrang eines Cargobikes wirken. Kombiniert mit einem konstruktiv abgestimmten KMC-Ritzel und -Kettenblatt die perfekte Lösung für den harten Alltags Einsatz – auch an unmotorisierten Lastenrädern.

Kompatibel mit allen Nabenschaltungen oder Direktantrieben mit Kettenblättern und Ritzeln 1/2" x 1/8" (3 mm).



**NEU!**  
**eCargo1**



ART.-NR. 	BESCHREIBUNG	DESCRIPTION	
<b>374046</b> 50 set	<b>BOWDENZÜGE FÜR SCHALTUNGEN</b> <b>UNIVERSAL-SET für vorne und hinten</b> <ul style="list-style-type: none"> <li>inklusive Außenhüllen: 2.500 mm, Ø 4 mm, SP-Konstruktion</li> <li>Innenzüge aus <b>Nirosta-Draht</b> (1,2 mm): 1 x 1.500 mm und 1 x 2.100 mm jeweils mit Nippel 4 x 4 mm und 10 x 2,5 mm</li> <li><b>inkl. Endhülsen</b> (9 für Außenhüllen und 2 für Züge) und <b>O-Ringen</b> (2 Sets à 3 Stk.)</li> <li>gerollt, in Promax <b>Eurolochbox</b></li> </ul>	<b>CABLES + OUTER HOUSINGS FOR DERAILLEURS</b> <b>UNIVERSAL SET for front and rear</b> <ul style="list-style-type: none"> <li>including outer housing: 2,500 mm, Ø 4 mm, SP-construction</li> <li>inner cables made of <b>stainless wire</b> (1.2 mm): 1 x 1,500 mm and 1 x 2,100 mm each with nipple 4 x 4 mm and 10 x 2.5 mm</li> <li><b>incl. cable end caps</b> (9 for outer housing and 2 for cables) and <b>o-rings</b> (2 sets per 3 pcs.)</li> <li>rolled, in Promax <b>eurohole box</b></li> </ul> <p style="text-align: right;">UVP 9,90 €</p>	<p>Tested by the manufacturer based on ISO 4210 </p>
<b>374480</b> 100/10	<b>MODELL UNIVERSAL</b> , für alle gängigen Ketten und Nabenschaltungen (auch für Drehgriffschalthebel) <ul style="list-style-type: none"> <li>Nippel 10 x 2,6 mm und 4 x 4 mm</li> <li>12 Drähte</li> <li>2.200/2.100 mm</li> <li>gerollt und mit Kabelbinder gehalten</li> <li>10 Stk. im Polybeutel</li> </ul>	<b>MODEL UNIVERSAL</b> , suitable for all normal derailleur and hub shifting systems (also for grip shifters) <ul style="list-style-type: none"> <li>nipple 10 x 2.6 mm and 4 x 4 mm</li> <li>12 wires</li> <li>2,200/2,100 mm</li> <li>rolled and fixed with cable tie</li> <li>10 pcs. in PE bag</li> </ul> <p style="text-align: right;">UVP 2,50 €</p>	
<b>372065</b> 50 set	<b>BOWDENZÜGE FÜR BREMSEN</b> <b>UNIVERSAL-SET für vorne und hinten</b> <ul style="list-style-type: none"> <li>inklusive Außenhüllen: 2.500 mm</li> <li>Innenzüge aus <b>Nirosta-Draht</b>: 1 x 1.350 mm und 1 x 2.350 mm</li> <li>jeweils mit Zylindernippeln 7 x 6 mm und Birnennippeln 6 x 9 mm</li> <li><b>inkl. Endhülsen</b> (6 für Außenhüllen und 2 für Züge) und <b>O-Ringe</b> (2 Sets à 3 Stk.)</li> <li>gerollt, in Promax <b>Eurolochbox</b></li> </ul>	<b>CABLES + OUTER HOUSINGS FOR BRAKES</b> <b>UNIVERSAL SET for front and rear</b> <ul style="list-style-type: none"> <li>including outer housings: 2,500 mm</li> <li>inner cables made of <b>stainless wire</b>: 1 x 1,350 mm and 1 x 2,350 mm</li> <li>each with barrel nipples 7 x 6 mm and pear nipples 6 x 9 mm</li> <li><b>incl. cable end caps</b> (6 for outer housings and 2 for cables) and <b>o-rings</b> (2 sets per 3 pcs.)</li> <li>rolled, in Promax <b>eurohole box</b></li> </ul> <p style="text-align: right;">UVP 9,90 €</p>	<p>Tested by the manufacturer based on ISO 4210 </p>
<b>373343</b> 100/10	<b>MODELL UNIVERSAL</b> <ul style="list-style-type: none"> <li>1,5 mm Innenzug</li> <li>19 Drähte</li> <li><b>Birnennippel</b> 6 x 8 mm (Rennrad) und <b>Zylindernippel</b> 7 x 6 mm (MTB/ Trekking)</li> <li>1.830/1.700 mm</li> <li><b>mit Gleithülle</b></li> <li>gerollt und mit 2 <b>Kabelbindern</b> gehalten</li> <li>10 Stk. im Polybeutel</li> </ul>	<b>MODEL UNIVERSAL</b> <ul style="list-style-type: none"> <li>1.5 mm inner cable</li> <li>19 wires</li> <li><b>pear nipple</b> 6 x 8 mm (race) and <b>barrel nipple</b> 7 x 6 mm (MTB/ Trekking)</li> <li>1,830/1,700 mm</li> <li><b>with slick coating outer housing</b></li> <li>rolled and fixed with 2 <b>cable ties</b></li> <li>10 pcs. in PE bag</li> </ul> <p style="text-align: right;">UVP 2,90 €</p>	
<b>372340</b> 400/10  <b>372341</b> 100/10	wie Modell Universal, aber nur mit <b>Zylindernippel</b> 7 x 6 mm  780/650 mm  1.830/1.700 mm	like model universal, but only with <b>barrel nipple</b> 7 x 6 mm  780/650 mm  1,830/1,700 mm <p style="text-align: right;">UVP 1,50 €  UVP 1,90 €</p>	



ART.-NR.	BESCHREIBUNG	DESCRIPTION
372091 200	<p><b>BMX BREMSKABEL</b></p> <ul style="list-style-type: none"> <li>für <b>Rotorbremsen</b> (für vorne)</li> <li><b>Universalzug: Länge individuell einstellbar</b></li> <li>Gesamtlänge: bis 520 mm</li> <li>Innenzug: Einfachzug bis 255 mm mit verschiebbarem Nippel zur Regulierung der Länge</li> <li>Außenhülle: 210 mm (Einfachzug), 190/210 mm (Doppelzug)</li> <li>Montageverpackung</li> </ul>	<p><b>BMX BRAKE CABLE</b></p> <ul style="list-style-type: none"> <li>for <b>rotor brakes</b> (for front)</li> <li><b>brake cable for universal use: individually adjustable length</b></li> <li>full length: up to 520 mm</li> <li>inner cable: single cable up to 255 mm with movable nipple to regulate the length</li> <li>outer housing: 210 mm (single cable), 190/210 mm (double cable)</li> <li>OEM</li> </ul>
		UVP 4,90 €
372090 200/10	<p>für <b>Rotorbremsen</b> (für hinten)</p> <ul style="list-style-type: none"> <li>Innenzug: 1.200 mm</li> <li>Außenhülle: 450 mm (Einfachzug), 250 mm (Doppelzug)</li> <li>Montageverpackung</li> </ul>	<p>for <b>rotor brakes</b> (for rear)</p> <ul style="list-style-type: none"> <li>inner cable: 1,200 mm</li> <li>outer housing: 450 mm (single cable), 250 mm (double cable)</li> <li>OEM</li> </ul>
		UVP 3,90 €

INNENZÜGE INNER CABLES

INNENZÜGE FÜR SCHALTUNGEN	INNER CABLES FOR DERAILLEURS
<ul style="list-style-type: none"> <li>aus <b>Nirosta-Draht</b></li> <li>mit Nippel 4 x 4 mm</li> <li>Enden <b>verschmolzen</b></li> <li>2.200 mm</li> <li><b>vorgefettet</b></li> <li>100 Stk. in Promax <b>Karton</b></li> </ul>	<ul style="list-style-type: none"> <li>made of <b>stainless steel wire</b></li> <li>with nipple 4 x 4 mm</li> <li>cable ends <b>welded</b></li> <li>2,200 mm</li> <li><b>ready greased</b></li> <li>100 pcs. in Promax <b>box</b></li> </ul>
<p>374049 Ø 1,2 mm</p> <p>374037 Ø 1,1 mm (z. B. für Campagnolo)</p> <p>5 boxes</p>	<p>Ø 1.2 mm</p> <p>Ø 1.1 mm (e. g. for Campagnolo)</p> <p>UVP 119,00 €</p>
<p><b>Slick-Zug aus Nirosta-Draht</b></p> <ul style="list-style-type: none"> <li>19 Nirosta-Stahlröhre</li> <li>Enden <b>verschmolzen</b></li> <li>Ø 1,1 mm</li> <li>2.100 mm</li> <li>gerollt</li> <li>mit <b>Header</b></li> </ul>	<p><b>Slick cable made of stainless steel wire</b></p> <ul style="list-style-type: none"> <li>19 stainless steel wires</li> <li>cable ends <b>welded</b></li> <li>Ø 1.1 mm</li> <li>2,100 mm</li> <li>rolled</li> <li>with <b>header</b></li> </ul>
<p>374045 mit <b>Gleitbeschichtung</b></p> <p>500/10</p>	<p>with <b>slick coating</b></p> <p>UVP 2,90 €</p>
<p>374042</p> <ul style="list-style-type: none"> <li>verzinkt</li> <li>Ø 1,2 mm</li> <li>10 Stk. im Polybeutel</li> </ul>	<ul style="list-style-type: none"> <li>zinc plated</li> <li>Ø 1.2 mm</li> <li>10 pcs in PE bag</li> </ul> <p>UVP 99,90 €/100</p>

Tested by the manufacturer based on ISO 4210

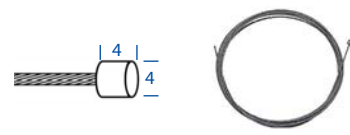
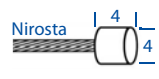















ART.-NR.	BESCHREIBUNG	DESCRIPTION	
<b>374027</b> 500/10	<b>INNENZÜGE FÜR SCHALTUNGEN</b> <b>Universalschaltzug für alle gängigen Ketten- und Nabenschaltungen</b> (auch passend für Drehgriffschalthebel) <ul style="list-style-type: none"> <li>• mit Nippel 4 x 4 mm und 10 x 2,5 mm</li> <li>• 12 Drähte</li> <li>• Ø 1,2 mm</li> <li>• 2.100 mm</li> <li>• gerollt und mit 2 Kabelbindern gehalten</li> <li>• 10 Stk. im Polybeutel</li> </ul>	<b>INNER CABLES FOR DERAILLEURS</b> <b>universal derailleur cable, suitable for all normal derailleur and international hubshifting systems</b> (also for grip shifter) <ul style="list-style-type: none"> <li>• with nipple 4 x 4 mm and 10 x 2.5 mm</li> <li>• 12 wires</li> <li>• Ø 1.2 mm</li> <li>• 2,100 mm</li> <li>• rolled and fixed with 2 cable ties</li> <li>• 10 pcs. in PE bag</li> </ul> <p style="text-align: right;">UVP 99,90 €/100</p>	
<b>372086</b> 5 boxes	<b>INNENZÜGE FÜR BREMSEN</b> <ul style="list-style-type: none"> <li>• aus <b>Nirosta-Draht</b></li> <li>• Ø 1,5 mm x 2.000 mm</li> <li>• mit <b>Zylindernippel 7 x 6 mm</b></li> </ul> <ul style="list-style-type: none"> <li>• <b>vorgefettet</b></li> <li>• 100 Stk. in Promax <b>Karton</b></li> </ul>	<b>INNER CABLES FOR BRAKES</b> <ul style="list-style-type: none"> <li>• made of <b>stainless steel wire</b></li> <li>• Ø 1.5 mm x 2,000 mm</li> <li>• with <b>barrel nipple 7 x 6 mm</b></li> </ul> <ul style="list-style-type: none"> <li>• <b>ready greased</b></li> <li>• 100 pcs. in Promax <b>box</b></li> </ul> <p style="text-align: right;">UVP 119,00 €/1</p>	<p>Tested by the manufacturer based on ISO 4210</p>
<b>372069</b> 500/10	mit Promax <b>Eurolochheader</b>	with Promax <b>eurohole header</b>	
<b>372078</b> 5 boxes	<ul style="list-style-type: none"> <li>• aus <b>Nirosta-Draht</b></li> <li>• Ø 1,5 mm x 2.000 mm</li> <li>• mit <b>Birnennippel 6 x 9 mm</b></li> <li>• für Rennrad und Kupplung</li> </ul> <ul style="list-style-type: none"> <li>• <b>vorgefettet</b></li> <li>• 100 Stk. in Promax <b>Karton</b></li> </ul>	<ul style="list-style-type: none"> <li>• made of <b>stainless steel wire</b></li> <li>• Ø 1.5 mm x 2,000 mm</li> <li>• with <b>pear nipple 6 x 9 mm</b></li> <li>• for racing and clutch</li> </ul> <ul style="list-style-type: none"> <li>• <b>ready greased</b></li> <li>• 100 pcs. in Promax <b>box</b></li> </ul> <p style="text-align: right;">UVP 119,00 €/1</p>	
<b>372080</b> 500/10	mit Promax <b>Eurolochheader</b>	with Promax <b>eurohole header</b>	
<b>372020</b> 850 mm	<ul style="list-style-type: none"> <li>• mit Zylindernippel 7 x 6 mm</li> <li>• 19 Drähte</li> <li>• gerollt, 10 Stk. im Polybeutel</li> </ul>	<ul style="list-style-type: none"> <li>• with barrel nipple 7 x 6 mm</li> <li>• 19 wires</li> <li>• rolled, 10 pcs. in PE bag</li> </ul> <p style="text-align: right;">UVP 99,90 €/100</p>	
<b>372021</b> 500/10	1.800 mm	1,800 mm	<p style="text-align: right;">UVP 99,90 €/100</p>
<b>374034</b> 500/10	<ul style="list-style-type: none"> <li>• <b>Universal-Innenzug</b></li> <li>• mit Birnennippel 6 x 8 mm (für <b>Rennrad und Kupplung</b>) und Zylindernippel 7 x 6 mm (für MTB/Trekking)</li> <li>• 19 Drähte</li> <li>• Ø 1,5 mm</li> <li>• 2.000 mm</li> <li>• gerollt, 10 Stk. im Polybeutel</li> </ul>	<ul style="list-style-type: none"> <li>• <b>universal</b> inner cable</li> <li>• with pear nipple 6 x 8 mm (for <b>racing and clutch</b>) and barrel nipple 7 x 6 mm (for MTB, Trekking)</li> <li>• 19 wires</li> <li>• Ø 1.5 mm</li> <li>• 2,000 mm</li> <li>• rolled, 10 pcs. in PE bag</li> </ul> <p style="text-align: right;">UVP 99,90 €/100</p>	

ART.-NR.	BESCHREIBUNG	DESCRIPTION	
<b>AUSSENZÜGE</b>		<b>OUTER CABLES</b>	
<p><b>370038</b></p> <p><b>370039</b></p> <p>8 boxes</p>	<p><b>AUSSENHÜLLEN FÜR SCHALTUNGSZÜGE</b></p> <ul style="list-style-type: none"> <li>• <b>SP-Konstruktion</b></li> <li>• innen mit <b>Gleithülle</b></li> <li>• <b>Längsdrähte</b></li> <li>• für Schaltunugszüge Ø 1,2 mm</li> <li>• 30 m in Promax <b>Karton</b></li> </ul> <p>Außen-Ø <b>5 mm</b></p> <p>Außen-Ø <b>4 mm</b></p>	<p><b>OUTER HOUSINGS FOR DERAILLEUR CABLES</b></p> <ul style="list-style-type: none"> <li>• <b>SP-construction</b></li> <li>• with <b>slick coating</b> inside</li> <li>• <b>straight wires</b></li> <li>• for derailleur cables Ø 1.2 mm</li> <li>• 30 m in Promax <b>box</b></li> </ul> <p>outer-Ø <b>5 mm</b></p> <p>outer-Ø <b>4 mm</b></p>	<p>Tested by the manufacturer based on ISO 4210</p>  <p>PROMAX</p>
<p>• <b>370035</b></p> <p>20 rolls</p>	<ul style="list-style-type: none"> <li>• schwarz</li> <li>• Außen-Ø <b>4 mm</b></li> <li>• auf <b>10 m Rolle</b></li> <li>• Montageverpackung</li> </ul>	<ul style="list-style-type: none"> <li>• black</li> <li>• outer-Ø <b>4 mm</b></li> <li>• on <b>10 m roll</b></li> <li>• OEM</li> </ul>	<p>10 m</p> 
<p><b>370058</b></p> <p>8 boxes</p>	<p><b>AUSSENHÜLLE FÜR BREMSZÜGE</b></p> <ul style="list-style-type: none"> <li>• <b>2 P</b> (= innen mit <b>Gleithülle</b>)</li> <li>• für 1,6 - 2,0 mm Brems- (und Schaltungs-) züge</li> <li>• 30 m in Promax <b>Karton</b></li> <li>• Innen-Ø 2,7 mm</li> <li>• Außen-Ø 5,0 mm</li> </ul>	<p><b>OUTER HOUSING FOR BRAKE CABLES</b></p> <ul style="list-style-type: none"> <li>• <b>2 P</b> (= with <b>slick coating</b> inside)</li> <li>• for 1.6 - 2.0 mm brake (and derailleur) cables</li> <li>• 30 m in Promax <b>box</b></li> <li>• inner-Ø 2.7 mm</li> <li>• outer-Ø 5.0 mm</li> </ul>	<p>Tested by the manufacturer based on ISO 4210</p>  <p>PROMAX</p>
<p>• <b>372542</b></p> <p>1 roll</p>	<ul style="list-style-type: none"> <li>• <b>500 m Rolle</b></li> <li>• schwarz</li> <li>• Montageverpackung</li> </ul>	<ul style="list-style-type: none"> <li>• <b>500 m roll</b></li> <li>• black</li> <li>• OEM</li> </ul>	<p>500 m</p> 
<p><b>372552</b></p> <p>20 rolls</p>	<ul style="list-style-type: none"> <li>• <b>20 m Rolle</b></li> <li>• schwarz</li> <li>• Montageverpackung</li> </ul>	<ul style="list-style-type: none"> <li>• <b>20 m roll</b></li> <li>• black</li> <li>• OEM</li> </ul>	<p>20 m</p> 
<p><b>374257</b></p> <p>10 spool</p> <p><b>NEW</b></p>	<p><b>SPIRALSCHLAUCH</b></p> <ul style="list-style-type: none"> <li>• saubere und einfache Anwendung</li> <li>• <b>100 m auf Spule</b></li> <li>• Außen-Ø 6 mm</li> <li>• Innen-Ø 4,8 mm</li> <li>• Montageverpackung</li> </ul>	<p><b>SPIRAL COILED TUBE</b></p> <ul style="list-style-type: none"> <li>• clean and simple application</li> <li>• <b>100 m on spool</b></li> <li>• outer-Ø 6 mm</li> <li>• inner-Ø 4.8 mm</li> <li>• OEM</li> </ul>	<p>100 m</p> 
<p><b>370295</b></p> <p>250 set</p>	<p><b>KABELFÜHRUNG</b></p> <ul style="list-style-type: none"> <li>• für 4-5 mm Außenhüllen</li> <li>• kann <b>universell durch Kabelbinder</b> am Rahmen befestigt oder <b>aufgeklebt</b> werden</li> <li>• 3 Stk. im Polybeutel mit M-Wave Eurolochheader</li> </ul>	<p><b>CABLE GUIDE</b></p> <ul style="list-style-type: none"> <li>• for 4-5 mm outer housings</li> <li>• can <b>universally</b> be mounted to frames with <b>cable ties</b> or <b>sticker</b></li> <li>• 3 pcs. in PE bag with M-Wave eurohole header</li> </ul>	 <p>M-WAVE</p> <p><b>3 BEFESTIGUNGSMÖGLICHKEITEN</b> <b>3 ATTACHMENT POSSIBILITIES</b></p>  <p>UVP 6,90 €</p>

ART.-NR. 	BESCHREIBUNG	DESCRIPTION	
<b>370290</b> 200 set	<b>ZUGFEINEINSTELLHILFE</b> <ul style="list-style-type: none"> <li>zur <b>Feinjustierung</b> der Zugspannung</li> <li><b>Aluminium</b>, nur 3,9 g pro Stück</li> <li>für Außenhüllen Ø 4 + 5 mm</li> <li>1 Set = 2 Stk. im Polybeutel mit Eurolochheader</li> </ul>	<b>ADJUSTER FOR INNER CABLES</b> <ul style="list-style-type: none"> <li>for <b>vernier adjustment</b> of the cable tension</li> <li><b>aluminium</b>, only 3.9 g per piece</li> <li>for outer housings Ø 4 + 5 mm</li> <li>1 set = 2 pcs. in PE bag with eurohole header</li> </ul>	<p>Tested by the manufacturer based on ISO 4210</p> <p>UVP 5,90 €/Set</p>
<b>370210</b> <b>370231</b> <b>370232</b>  <b>370211</b> <b>370236</b> <b>370237</b> <b>370238</b> 25.000/200	<b>AUSSENHÜLLENENDHÜLSEN</b> <ul style="list-style-type: none"> <li><b>CNC-gefräst</b></li> <li>12 mm lang</li> <li>200 Stk. in M-Wave Dose</li> <li>Innen-Ø <b>4,1 mm</b></li> <li>für Schalt-/ (Brems-)zughüllen</li> </ul> <ul style="list-style-type: none"> <li>rot eloxiert</li> <li>blau eloxiert</li> <li>grün eloxiert</li> </ul> <ul style="list-style-type: none"> <li>Innen-Ø <b>5,1 mm</b></li> <li>für Brems-/ (Schalt-)zughüllen</li> </ul> <ul style="list-style-type: none"> <li>rot eloxiert</li> <li>blau eloxiert</li> <li>grün eloxiert</li> <li>gold-orange eloxiert</li> </ul>	<b>OUTER HOUSING END CAPS</b> <ul style="list-style-type: none"> <li><b>CNC machined</b></li> <li>length 12 mm</li> <li>200 pcs. in M-Wave can</li> <li>inner-Ø <b>4.1 mm</b></li> <li>for derailleur/ (brake) cable outer housings</li> </ul> <ul style="list-style-type: none"> <li>red anodised</li> <li>blue anodised</li> <li>green anodised</li> </ul> <ul style="list-style-type: none"> <li>inner-Ø <b>5.1 mm</b></li> <li>for brake/ (derailleur) cable outer housings</li> </ul> <ul style="list-style-type: none"> <li>red anodised</li> <li>blue anodised</li> <li>green anodised</li> <li>gold-orange anodised</li> </ul>	<p><b>CNC</b></p> <p>UVP 249,00 €/1.000</p>
<b>370270</b> • <b>370202</b>  <b>370271</b> • <b>370203</b> 14.400/2.400	<b>AUSSENHÜLLENENDHÜLSEN MIT KOLLARS-SYSTEM</b> <p>Die <b>Innenflächen</b>, an der sich die Enden der Außenhülle abstützen, <b>fallen nach außen ab</b>. Dadurch werden die Drähte der Außenhüllen nach <b>außen gedrängt</b> und hindern somit das Innenkabel nicht am <b>reibungslosen Lauf</b>.</p> <ul style="list-style-type: none"> <li>für Schalt- und Bremszughüllen</li> <li><b>CNC-gefräst</b></li> <li><b>Kollars Design</b></li> <li>200 Stk. in Promax Dose</li> </ul> <ul style="list-style-type: none"> <li>Innen-Ø <b>4,1 mm</b></li> </ul> <ul style="list-style-type: none"> <li>schwarz</li> <li>silber</li> </ul> <ul style="list-style-type: none"> <li>Innen-Ø <b>5,1 mm</b></li> </ul> <ul style="list-style-type: none"> <li>schwarz</li> <li>silber</li> </ul>	<b>OUTER HOUSING END CAPS WITH KOLLARS SYSTEM</b> <p>The <b>internal surfaces</b>, of which the ends of the outer housing firm up, <b>slope to the sides</b>. The wires of the outer housings are <b>pressed to the sides</b> and so cannot prevent the inner cable from <b>smooth running</b>.</p> <ul style="list-style-type: none"> <li>for derailleur and brake cable outer housings</li> <li><b>CNC machined</b></li> <li><b>Kollars Design</b></li> <li>200 pcs. in Promax can</li> </ul> <ul style="list-style-type: none"> <li>inner-Ø <b>4.1 mm</b></li> </ul> <ul style="list-style-type: none"> <li>black</li> <li>silver</li> </ul> <ul style="list-style-type: none"> <li>inner-Ø <b>5.1 mm</b></li> </ul> <ul style="list-style-type: none"> <li>black</li> <li>silver</li> </ul>	<p>Tested by the manufacturer based on ISO 4210</p> <p>UVP 175,00 €/1.000 UVP 97,90 €/1.000 UVP 175,00 €/1.000 UVP 99,90 €/1.000</p>
<b>370272</b> • <b>370273</b> 14.400/2.400	<ul style="list-style-type: none"> <li>Innen-Ø <b>5,1 mm</b></li> <li>mit 2,5 mm Loch</li> <li>nicht CNC-gefräst</li> </ul> <ul style="list-style-type: none"> <li>schwarz</li> <li>silber</li> </ul>	<ul style="list-style-type: none"> <li>inner-Ø <b>5.1 mm</b></li> <li>with 2.5 mm hole</li> <li>not CNC machined</li> </ul> <ul style="list-style-type: none"> <li>black</li> <li>silver</li> </ul>	<p>UVP 75,90 €/1.000 UVP 59,90 €/1.000</p>



ART.-NR.	BESCHREIBUNG	DESCRIPTION	
 • <b>370201</b> 20.000/100	<b>AUSSENHÜLLENENDHÜLSEN</b> • <b>Kunststoff</b> • 100 Stk. im Polybeutel • für Schaltungszughüllen • Innen-Ø 4 mm	<b>OUTER HOUSING END CAPS</b> • <b>plastic</b> • 100 pcs. in PE bag • for derailleur cable outer housings • inner-Ø 4 mm UVP 49,90 €/1.000	  
• <b>370287</b> 30.000/100	• für Brems-/(Schaltungs-)zughüllen • Innen-Ø 5 mm	• for brake/(derailleur) cable outer housings • inner-Ø 5 mm UVP 49,90 €/1.000	
<b>370300</b> 7.500/250	<b>UNIVERSALANSCHLAGHÜLSE</b> • Aluminium • für Bowdenzug • 4 x 7,5 mm • 250 Stk. im Polybeutel	<b>UNIVERSAL CABLE COVER CAP</b> • aluminium • for bowden cable • 4 x 7.5 mm • 250 pcs. in PE bag UVP 0,29 €	
<b>370218</b>  <b>370217</b>  <b>370226</b>  <b>370227</b>  <b>370228</b> 75.000/500	<b>ENDHÜLSE FÜR INNENZÜGE</b> • <b>Aluminium</b> • Innen-Ø ca. 1,7 x 10 mm Länge • 500 Stk. in M-Wave Dose	<b>END CAP FOR INNER CABLES</b> • <b>aluminium</b> • inner-Ø approx. 1.7 mm x 10 mm length • 500 pcs. in M-Wave can	     
• <b>370283</b> 100.000/1.000	• silber • 2,1/2,9 x 10,3 mm • 1.000 Stk. in Dose	• silver • 2,1/2,9 x 10,3 mm • 1,000 pcs. in can UVP 49,90 €/1.000	  







# MOTUL



[www.motul.messingschlager.com](http://www.motul.messingschlager.com)











# MUD- GUARDS





ART.-NR.	BESCHREIBUNG	DESCRIPTION	
<p><b>NEW</b></p> <p><b>385137</b></p> <p><b>385138</b></p> <p>16 set</p>	<p><b>SCHUTZBLECH-SET</b></p> <ul style="list-style-type: none"> <li>für Vorder- und Hinterrad</li> <li>Kunststoff</li> <li><b>Länge werkzeuglos verstellbar</b></li> <li>Steckbefestigung</li> <li>auf M-Wave Eurolochkarte</li> </ul> <p><b>›MUD MAX F+R ADJ L‹</b></p> <ul style="list-style-type: none"> <li>universell passend für <b>26" - 29"</b></li> <li>mit <b>Sicherheitsstrebenbefestigung</b></li> <li>max. Reifenbreite: 62 mm</li> </ul> <p><b>›MUD MAX F+R ADJ S‹</b></p> <ul style="list-style-type: none"> <li>universell passend für <b>20" - 24"</b></li> <li>max. Reifenbreite: 55 mm</li> </ul>	<p><b>MUDGUARD SET</b></p> <ul style="list-style-type: none"> <li>front and rear</li> <li>plastic</li> <li><b>length adjustable without tools</b></li> <li>clip-on system</li> <li>on M-Wave eurohole card</li> </ul> <p><b>›MUD MAX F+R ADJ L‹</b></p> <ul style="list-style-type: none"> <li>universal type for <b>26" - 29"</b></li> <li>with <b>safety stays</b></li> <li>max. tire width: 62 mm</li> </ul> <p>UVP 27,90 €</p> <p><b>›MUD MAX F+R ADJ S‹</b></p> <ul style="list-style-type: none"> <li>universal type for <b>20" - 24"</b></li> <li>max. tire width: 55 mm</li> </ul> <p>UVP 16,90 €</p>	
<p><b>386080</b></p> <p>30 set</p> <p><b>386085</b></p> <p>50 set</p>	<p><b>SCHUTZBLECH-SET</b> <b>›MUD MAX UNIVERSAL‹ 26" - 29"</b></p> <ul style="list-style-type: none"> <li>für Vorder- und Hinterrad</li> <li><b>universell</b> passend für <b>26" - 29"</b></li> <li>Kunststoff</li> <li><b>seitliche Versteifungen</b></li> <li>variable Steckbefestigung</li> <li>passend für V- und Cantilever-Bremsen</li> <li>mit <b>langem Spritzschutz</b></li> </ul> <p>in M-Wave Verpackung</p> <p>Set im Polybeutel</p>	<p><b>MUDGUARD SET</b> <b>›MUD MAX UNIVERSAL‹ 26" - 29"</b></p> <ul style="list-style-type: none"> <li>front and rear</li> <li><b>universal</b> type for <b>26" - 29"</b></li> <li>plastic</li> <li><b>reinforced sides</b></li> <li>variable clip-on system</li> <li>for V- and cantilever brakes</li> <li>with <b>long end</b></li> </ul> <p>in M-Wave packaging</p> <p>set in PE bag</p> <p>UVP 9,90 €</p>	
<p><b>386086</b></p> <p>50 set</p>	<p>wie Art. 386085, aber</p> <ul style="list-style-type: none"> <li>mit <b>Klettband</b> für zusätzliche Sicherheitsbefestigung am Sitzrohr</li> <li>Set auf M-Wave <b>Eurolochkarte</b></li> </ul>	<p>like art. 386085, but</p> <ul style="list-style-type: none"> <li>with <b>hook and loop fastener</b> for additional security fixing at the seat tube</li> <li>set on M-Wave <b>eurohole card</b></li> </ul> <p>UVP 8,90 €</p>	
<p><b>386047</b></p> <p>30 set</p> <p><b>386048</b></p> <p>50 set</p>	<p><b>SCHUTZBLECH-SET 26"</b></p> <ul style="list-style-type: none"> <li>für Vorder- und Hinterrad</li> <li><b>26"</b>, MTB</li> <li>Modell <b>›ECO‹</b></li> <li>Kunststoff</li> <li>passend für V- und Cantilever-Bremsen</li> <li>Steckbefestigung</li> </ul> <p>in M-Wave Verpackung</p> <p>Set im Polybeutel</p>	<p><b>MUDGUARD SET 26"</b></p> <ul style="list-style-type: none"> <li>front and rear</li> <li><b>26"</b>, MTB</li> <li>model <b>›ECO‹</b></li> <li>plastic</li> <li>for V- and cantilever brakes</li> <li>clip-on system</li> </ul> <p>in M-Wave packaging</p> <p>set in PE bag</p> <p>UVP 6,90 €</p>	



ART.-NR. 	BESCHREIBUNG	DESCRIPTION	
<b>386031</b> 20 set	<b>SCHUTZBLECH-SET 28"</b> <b>›MUD MAX II F+R‹</b> <ul style="list-style-type: none"> <li>• für Vorder- und Hinterrad</li> <li>• <b>28"</b></li> <li>• Breite: 45 mm</li> <li>• aus <b>hochwertigem, flexiblem Kunststoff: ohne Beschädigung knick- und drehbar</b></li> <li>• <b>Sicherheitsstrebenbefestigung aus Nirosta</b></li> <li>• Befestigungsmaterialien aus <b>Nirosta</b></li> <li>• langer <b>Spritzschutz aus Gummi hinten</b></li> <li>• auf M-Wave Eurolochkarte</li> </ul> <p><b>Ab einer Mindestmenge von 500 Paar sind diese Schutzbleche ohne Aufpreis auch in blau, rot, gelb, schwarz, grau oder weiß erhältlich!</b>  <b>Spritzschutz in 12 verschiedenen Farben erhältlich.</b></p>	<b>MUDGUARD SET 28"</b> <b>›MUD MAX II F+R‹</b> <ul style="list-style-type: none"> <li>• front and rear</li> <li>• <b>28"</b></li> <li>• width: 45 mm</li> <li>• <b>high quality flexible plastic: turnable and bendable without damage</b></li> <li>• <b>stainless steel safety stays</b></li> <li>• mounting materials made of <b>stainless steel</b></li> <li>• long <b>rubber end at the rear</b></li> <li>• on M-Wave eurohole card</li> </ul> <p>UVP 25,90 €</p> <p><b>From a minimum of 500 pairs, these mudguards are also available in blue, red, yellow, black, grey or white without upcharge!</b>  <b>Rubber end available in 12 different colours.</b></p>	 
<b>386096</b> 50 set	<b>SCHUTZBLECH-SET 26" - 29"</b> <b>›MUD MAX III‹</b> <ul style="list-style-type: none"> <li>• für Vorder- und Hinterrad</li> <li>• <b>universell</b> passend für <b>26" - 29"</b></li> <li>• Kunststoff</li> <li>• Steckbefestigung und <b>Sicherheitsstrebenbefestigung</b></li> <li>• mit <b>langem Spritzschutz</b></li> <li>• Set im Polybeutel</li> </ul>	<b>MUDGUARD SET 26" - 29"</b> <b>›MUD MAX III‹</b> <ul style="list-style-type: none"> <li>• front and rear</li> <li>• <b>universal</b> type for <b>26" - 29"</b></li> <li>• plastic</li> <li>• clip-on system and <b>safety stays</b></li> <li>• with <b>long end</b></li> <li>• set in PE bag</li> </ul> <p>UVP 11,90 €</p>	
<b>385088</b> 40 <b>NEW</b>	<b>STECK-SCHUTZBLECH</b> <b>›MUD MAX F III‹</b> <ul style="list-style-type: none"> <li>• für Vorderrad</li> <li>• universell passend für <b>26"-29"</b></li> <li>• auch für <b>Federgabeln</b> geeignet</li> <li>• mit <b>Clip-on-Halter</b> und <b>Konusbefestigung</b> im Gabelschaft (mit Adaptern für Ø 18 - 36 mm)</li> <li>• auf M-Wave Eurolochkarte</li> </ul>	<b>CLIP-ON MUDGUARD</b> <b>›MUD MAX F III‹</b> <ul style="list-style-type: none"> <li>• front</li> <li>• universal type for <b>26"-29"</b></li> <li>• to be used for <b>suspension forks</b> as well</li> <li>• with <b>clip-on bracket</b> and <b>coneclamp</b> in fork innertubes (with adapters for Ø 18 - 36 mm)</li> <li>• on M-Wave eurohole card</li> </ul> <p>UVP 24,90 €</p>	
<b>385089</b> 50 <b>NEW</b>	<b>STECK-SCHUTZBLECH</b> <b>›MUD MAX R III‹</b> <ul style="list-style-type: none"> <li>• für Hinterrad</li> <li>• universell passend für <b>26"-29"</b></li> <li>• mit universellem <b>Clip-on-Halter</b> passend für Sattelstützen</li> <li>• Winkel verstellbar</li> <li>• auf M-Wave Eurolochkarte</li> </ul>	<b>CLIP-ON MUDGUARD</b> <b>›MUD MAX R III‹</b> <ul style="list-style-type: none"> <li>• rear</li> <li>• universal type for <b>26"-29"</b></li> <li>• with universal <b>clip-on bracket</b> for seat posts</li> <li>• angle adjustable</li> <li>• on M-Wave eurohole card</li> </ul> <p>UVP 24,90 €</p>	



ART.-NR.	BESCHREIBUNG	DESCRIPTION	
<b>385070</b> 25	<b>STECKSCHUTZBLECH ›MUD MAX QR.F II‹</b> <ul style="list-style-type: none"> <li>• für Vorderrad</li> <li>• universell passend für <b>26" - 29"</b></li> <li>• auch für <b>Federgabeln</b> geeignet</li> <li>• mit <b>Konusbefestigung</b> im Gabelschaft (mit Adapter für Ø 18,5 – 34,5 mm)</li> <li>• auf M-Wave Eurolochkarte</li> </ul>	<b>CLIP ON MUDGUARD ›MUD MAX QR.F II‹</b> <ul style="list-style-type: none"> <li>• front</li> <li>• universal type for <b>26" - 29"</b></li> <li>• to be used for <b>suspension forks</b> as well</li> <li>• with <b>coneclamp</b> in fork innertube (with adapter for Ø 18.5 – 34.5 mm)</li> <li>• on M-Wave eurohole card</li> </ul>	 
<b>385071</b> 25	<b>STECKSCHUTZBLECH ›MUD MAX QR.R II‹</b> <ul style="list-style-type: none"> <li>• für Hinterrad</li> <li>• universell passend für <b>26" - 29"</b></li> <li>• mit universellem <b>Clip-on-Halter</b> passend für Sattelstütze und Rahmenrohr</li> <li>• stabile <b>3-Punkt Halterung</b> reduziert Flattern</li> <li>• <b>Winkel</b> und <b>Höhe verstellbar</b></li> <li>• auf M-Wave Eurolochkarte</li> </ul>	<b>CLIP ON MUDGUARD ›MUD MAX QR.R II‹</b> <ul style="list-style-type: none"> <li>• rear</li> <li>• universal type for <b>26" - 29"</b></li> <li>• with universal <b>clip-on bracket</b> for seat post and frame tube</li> <li>• stable <b>3 point fixation</b> reduces fluttering</li> <li>• <b>angle</b> and <b>height adjustable</b></li> <li>• on M-Wave eurohole card</li> </ul>	
<b>385130</b> 36 <b>NEW</b>	<b>STECK-SCHUTZBLECH ›MUD MAX QR.F III‹</b> <ul style="list-style-type: none"> <li>• für Vorderrad</li> <li>• universell passend für <b>26" - 29"</b></li> <li>• auch für <b>Federgabeln</b> geeignet</li> <li>• mit <b>Konusbefestigung</b> im Gabelschaft (mit Adapter für Ø 16 - 35 mm)</li> <li>• lässt sich in 2 Teilen von der Halterung abnehmen</li> <li>• max. Reifenbreite: 85 mm</li> <li>• auf M-Wave Eurolochkarte</li> </ul>	<b>CLIP-ON MUDGUARD ›MUD MAX QR.F III‹</b> <ul style="list-style-type: none"> <li>• front</li> <li>• universal type for <b>26" - 29"</b></li> <li>• to be used for <b>suspension forks</b> as well</li> <li>• with <b>coneclamp</b> in fork innertube (with adapter for Ø 16 - 35 mm)</li> <li>• can be removed from the bracket in 2 parts</li> <li>• max. tire width: 85 mm</li> <li>• on M-Wave eurohole card</li> </ul>	 
<b>385133</b> 48 <b>NEW</b>	<b>STECK-SCHUTZBLECH</b> <ul style="list-style-type: none"> <li>• für Hinterrad</li> <li>• mit universellem <b>Halter</b> passend für <b>Sattelstützen</b> mit Ø 24 - 36 mm</li> <li>• <b>Winkel verstellbar</b></li> <li>• auf M-Wave Eurolochkarte</li> </ul>	<b>CLIP-ON MUDGUARD</b> <ul style="list-style-type: none"> <li>• rear</li> <li>• with universal <b>bracket for seat posts</b> with Ø 24 - 36 mm</li> <li>• <b>angle adjustable</b></li> <li>• on M-Wave eurohole card</li> </ul>	
<b>385135</b> 36	<b>›MUD MAX QR.R III‹</b> <ul style="list-style-type: none"> <li>• universell passend für <b>26" - 29"</b></li> <li>• max. Reifenbreite: 85 mm</li> </ul>	<b>›MUD MAX QR.R III‹</b> <ul style="list-style-type: none"> <li>• universal type for <b>26" - 29"</b></li> <li>• max. tire width: 85 mm</li> </ul>	
<b>385135</b> 36	<b>›MUD MAX QR.R SLIM‹</b> <ul style="list-style-type: none"> <li>• <b>28"</b></li> <li>• für <b>Rennrad-, Gravel-, und Trekkingräder</b></li> <li>• max. Reifenbreite: 42 mm</li> </ul>	<b>›MUD MAX QR.R SLIM‹</b> <ul style="list-style-type: none"> <li>• <b>28"</b></li> <li>• for <b>road, gravel and trekking bikes</b></li> <li>• max. tire width: 42 mm</li> </ul>	

ART.-NR. 	BESCHREIBUNG	DESCRIPTION	
<b>385054</b> 20	<b>SCHUTZBLECH ›MUD MAX QR.F‹</b> <ul style="list-style-type: none"> <li>• für Vorderrad</li> <li>• universell passend für <b>26" - 29"</b></li> <li>• auch für <b>Federgabeln</b> geeignet</li> <li>• mit <b>Clip-on-Halter</b> und <b>Konusbefestigung</b> im Gabelschaft (mit Adaptern für Ø 18,5 - 34,5 mm)</li> <li>• auf M-Wave Eurolochkarte</li> </ul>	<b>MUDGUARD ›MUD MAX QR.F‹</b> <ul style="list-style-type: none"> <li>• front</li> <li>• universal type for <b>26" - 29"</b></li> <li>• to be used for <b>suspension forks</b> as well</li> <li>• with <b>clip-on bracket</b> and <b>coneclamp</b> in fork innertube (with adapters for Ø 18.5 - 34.5 mm)</li> <li>• on M-Wave eurohole card</li> </ul>	 <p>M-WAVE</p> <p>UVP 14,90 €</p>
<b>385055</b> 20	<b>SCHUTZBLECH ›MUD MAX QR.R‹</b> <ul style="list-style-type: none"> <li>• für Hinterrad</li> <li>• universell passend für <b>26" - 29"</b></li> <li>• Kunststoff</li> <li>• mit universellem <b>Clip-on-Halter</b> passend für Sattelstütze und Rahmenrohr</li> <li>• <b>Winkel</b> und <b>Höhe verstellbar</b></li> <li>• auf M-Wave Eurolochkarte</li> </ul>	<b>MUDGUARD ›MUD MAX QR.R‹</b> <ul style="list-style-type: none"> <li>• rear</li> <li>• universal type for <b>26" - 29"</b></li> <li>• plastic</li> <li>• with universal <b>clip-on bracket</b> for seat post and frame tube</li> <li>• <b>angle</b> and <b>height adjustable</b></li> <li>• on M-Wave eurohole card</li> </ul>	 <p>M-WAVE</p> <p>UVP 15,90 €</p>
<b>386205</b> 40	<b>SCHUTZBLECH ›MUD MAX FAT F‹</b> <ul style="list-style-type: none"> <li>• für Vorderrad</li> <li>• universell passend für <b>24" - 29"</b></li> <li>• Breite <b>115 mm</b></li> <li>• Kunststoff</li> <li>• mit <b>Konusbefestigung</b> im Gabelschaft <b>1" - 1 1/8"</b></li> <li>• <b>Winkel verstellbar</b></li> <li>• auf M-Wave Eurolochkarte</li> </ul>	<b>MUDGUARD ›MUD MAX FAT F‹</b> <ul style="list-style-type: none"> <li>• front</li> <li>• universal type for <b>24" - 29"</b></li> <li>• width <b>115 mm</b></li> <li>• plastic</li> <li>• with <b>coneclamp</b> in fork innertube <b>1" - 1 1/8"</b></li> <li>• <b>angle adjustable</b></li> <li>• on M-Wave eurohole card</li> </ul>	<p><b>PLUS / FAT ✓</b></p>  <p>M-WAVE</p> <p>UVP 19,90 €</p>
<b>386206</b> 20	<b>SCHUTZBLECH ›MUD MAX FAT R‹</b> <ul style="list-style-type: none"> <li>• für Hinterrad</li> <li>• universell passend für <b>24" - 29"</b></li> <li>• Breite <b>115 mm</b></li> <li>• Kunststoff</li> <li>• <b>werkzeuglose</b> Montage</li> <li>• mit universellem Halter passend für Sattelstütze und Sattelrohr, für Ø 27,2 - 33,5 mm</li> <li>• <b>Winkel</b> und <b>Höhe verstellbar</b></li> <li>• auf M-Wave Eurolochkarte</li> </ul>	<b>MUDGUARD ›MUD MAX FAT R‹</b> <ul style="list-style-type: none"> <li>• rear</li> <li>• universal type for <b>24" - 29"</b></li> <li>• width <b>115 mm</b></li> <li>• plastic</li> <li>• <b>toolless</b> mounting</li> <li>• with universal bracket suitable for seat post and frame tube, for Ø 27.2 - 33.5 mm</li> <li>• <b>angle</b> and <b>height adjustable</b></li> <li>• on M-Wave eurohole card</li> </ul>	 <p>M-WAVE</p> <p>UVP 24,90 €</p>

ART.-NR.	BESCHREIBUNG	DESCRIPTION	
<b>386030</b> 60	<b>SCHUTZBLECH ›MUD MAX II R‹</b> <ul style="list-style-type: none"> <li>für Hinterrad</li> <li>universell passend für <b>20" - 29"</b></li> <li>aus <b>hochwertigem, flexiblem Kunststoff: ohne Beschädigung knick- und drehbar</b></li> <li>inkl. Halter für Sattelstütze, passend für Ø 25,0 - 31,8 mm</li> <li><b>Winkel und Höhe</b> durch 2 Gelenke <b>zweifach verstellbar</b></li> <li>auf M-Wave Eurolochkarte</li> </ul>	<b>MUDGUARD ›MUD MAX II R‹</b> <ul style="list-style-type: none"> <li>for rear</li> <li>universal type for <b>20" - 29"</b></li> <li><b>high quality flexible plastic: turnable and bendable without damage</b></li> <li>incl. bracket for seat post, suitable for Ø 25.0 - 31.8 mm</li> <li><b>angle and height doubly adjustable</b> by two hinges</li> <li>on M-Wave eurohole card</li> </ul>	
<b>386091</b> 50	<b>SCHUTZBLECH</b> <ul style="list-style-type: none"> <li>für Vorderrad</li> <li>universell passend für <b>24" - 29"</b></li> <li>Kunststoff</li> <li>auch für <b>Federgabeln, Cantilever und V-Bremsen</b> geeignet</li> <li><b>universelle Montage</b> an der Gabel oder am Brake-Booster</li> </ul>	<b>MUDGUARD</b> <ul style="list-style-type: none"> <li>front</li> <li>universal type for <b>24" - 29"</b></li> <li>plastic</li> <li>also suitable for <b>suspension forks, cantilever and V-brakes</b></li> <li><b>universal assembling</b> at the fork or at brake booster</li> </ul>	
<b>385047</b> 50	<b>SCHUTZBLECH</b> <ul style="list-style-type: none"> <li>für Hinterrad</li> <li>universell passend für <b>20" - 29"</b></li> <li>Kunststoff</li> <li><b>werkzeuglose Montage</b></li> <li>mit Reflektorhalter</li> <li>inkl. Halter für Sattelstütze, passend für Ø 25,0 - 31,8 mm</li> <li><b>Winkel und Höhe</b> durch 2 Gelenke <b>zweifach verstellbar</b></li> <li>im Polybeutel</li> </ul>	<b>MUDGUARD</b> <ul style="list-style-type: none"> <li>rear</li> <li>universal type for <b>20" - 29"</b></li> <li>plastic</li> <li><b>toolless mounting</b></li> <li>with reflector bracket</li> <li>incl. clip for seat post, suitable for Ø 25.0 - 31.8 mm</li> <li><b>angle and height doubly adjustable</b> by two hinges</li> <li>in PE bag</li> </ul>	
<b>385025</b> 100/25	<b>SCHUTZBLECH</b> <ul style="list-style-type: none"> <li>für Vorderrad</li> <li>passend für <b>20" - 24"</b></li> <li>Kunststoff</li> <li>2-teilig</li> <li><b>Steckbefestigung</b></li> <li><b>werkzeuglose Montage</b></li> <li>im Polybeutel</li> </ul>	<b>MUGUARD</b> <ul style="list-style-type: none"> <li>front</li> <li>for <b>20" - 24"</b></li> <li>plastic</li> <li>two-piece-type</li> <li><b>clip-on system</b></li> <li><b>toolless mounting</b></li> <li>in PE bag</li> </ul>	
<b>385026</b> 100/25	<b>SCHUTZBLECH</b> <ul style="list-style-type: none"> <li>für Hinterrad</li> <li>passend für <b>20" - 24"</b></li> <li><b>Winkel und Höhe verstellbar</b></li> <li>Kunststoff</li> <li>im Polybeutel</li> </ul>	<b>MUGUARD</b> <ul style="list-style-type: none"> <li>rear</li> <li>for <b>20" - 24"</b></li> <li><b>angle and height adjustable</b></li> <li>plastic</li> <li>in PE bag</li> </ul>	

ART.-NR.	BESCHREIBUNG	DESCRIPTION	
<p><b>386033</b></p> <p><b>386032</b></p> <p>60 set</p>	<p><b>SCHUTZBLECH-SET ›MUD MAX KIDS F+R‹</b></p> <ul style="list-style-type: none"> <li>• für Vorder- und Hinterrad</li> <li>• aus <b>hochwertigem, flexiblem Kunststoff: ohne Beschädigung knick- und drehbar</b></li> <li>• <b>seitliche Versteifungen</b></li> <li>• passend für V- und Cantilever-Bremsen</li> <li>• variable <b>Steckbefestigung</b></li> <li>• langer <b>Spritzschutz aus Gummi hinten</b></li> <li>• auf M-Wave Eurolochkarte</li> </ul> <p><b>für 16" - 20" Kinderräder</b></p> <p><b>für 12" - 18" Kinderräder</b></p> <p><b>Ab einer Mindestmenge von 500 Paar sind diese Schutzbleche ohne Aufpreis auch in blau, rot, gelb, schwarz, grau oder weiß erhältlich! Spritzschutz in 12 verschiedenen Farben erhältlich.</b></p>	<p><b>MUDGUARD SET ›MUD MAX KIDS F+R‹</b></p> <ul style="list-style-type: none"> <li>• for front and rear</li> <li>• <b>high quality flexible plastic: turnable and bendable without damage</b></li> <li>• <b>reinforced sides</b></li> <li>• suitable for V- and cantilever brakes</li> <li>• variable <b>clip-on-system</b></li> <li>• long <b>rubber end at the rear</b></li> <li>• on M-Wave eurohole card</li> </ul> <p>for 16" - 20" children bikes UVP 13,90 €</p> <p>for 12" - 18" children bikes UVP 13,90 €</p> <p><b>From a minimum of 500 pairs, these mudguards are also available in blue, red, yellow, black, grey or white without upcharge! Rubber end available in 12 different colours.</b></p>	 <p>M-WAVE</p>
<p><b>386011</b></p> <p>50</p>	<p><b>DIRT BOARD ›MUD MAX DT‹</b></p> <ul style="list-style-type: none"> <li>• universelle Befestigung am Unterrohr</li> <li>• asymmetrisches Design für <b>optimalen Schutz bei unterschiedlichen Fahrpositionen</b> (180° drehbar)</li> <li>• <b>werkzeuglose</b> Montage mit 2 Gummibändern</li> <li>• aus schlagfestem Kunststoff</li> <li>• mit Non-Slip-Einlagen</li> <li>• ca. 32 x 9/13 cm</li> <li>• auf M-Wave Eurolochkarte</li> </ul>	<p><b>DIRT BOARD ›MUD MAX DT‹</b></p> <ul style="list-style-type: none"> <li>• universal mounting on the down tube</li> <li>• asymmetric design <b>to protect optimally in various drive positions</b> (180° turnable)</li> <li>• <b>toolless</b> mounting by two rubber strips</li> <li>• impact resistant plastic</li> <li>• with non-slip inlays</li> <li>• approx. 32 x 9/13 cm</li> <li>• on M-Wave eurohole card</li> </ul> <p>UVP 5,90 €</p>	 <p>NON-SLIP</p> <p>2 IN 1</p> <p>M-WAVE</p>
<p><b>385136</b></p> <p>45</p> <p><b>NEW</b></p>	<p><b>DIRT BOARD ›MUD MAX DT.S‹</b></p> <ul style="list-style-type: none"> <li>• schmale Ausführung für <b>Rennrad-, Gravel- und Trekkingräder</b></li> <li>• universelle Befestigung am Unterrohr</li> <li>• <b>werkzeuglose</b> Montage mit 2 Gummibändern</li> <li>• max. Reifenbreite: 60 mm</li> <li>• auf M-Wave Eurolochkarte</li> </ul>	<p><b>DIRT BOARD ›MUD MAX DT.S‹</b></p> <ul style="list-style-type: none"> <li>• narrow version <b>for road, gravel and trekking bikes</b></li> <li>• universal mounting on the down tube</li> <li>• <b>toolless mounting</b> by 2 rubber strips</li> <li>• max. tire width: 60 mm</li> <li>• on M-Wave eurohole card</li> </ul> <p>UVP 7,90 €</p>	 <p>M-WAVE</p>
<p><b>385131</b></p> <p>20</p> <p><b>NEW</b></p>	<p><b>UNIVERSAL SCHUTZBLECH ›MUD MAX FLEX F‹</b></p> <ul style="list-style-type: none"> <li>• für Vorderrad</li> <li>• universell passend für <b>26" - 29"</b></li> <li>• <b>strapazierfähiger Kunststoff</b></li> <li>• <b>werkzeuglose Befestigung an der Gabel</b></li> <li>• max. Reifenbreite: 82 mm</li> <li>• inkl. 6 Kabelbinder</li> <li>• auf M-Wave Eurolochkarte</li> </ul>	<p><b>UNIVERSAL MUDGUARD ›MUD MAX FLEX F‹</b></p> <ul style="list-style-type: none"> <li>• front</li> <li>• universal type for <b>26" - 29"</b></li> <li>• <b>hard-wearing plastic</b></li> <li>• <b>toolless attachment to the fork</b></li> <li>• max. tire width: 82 mm</li> <li>• incl. 6 cable ties</li> <li>• on M-Wave eurohole card</li> </ul> <p>UVP 9,90 €</p>	 <p>M-WAVE</p>





ART.-NR.	BESCHREIBUNG	DESCRIPTION	
<b>385132</b> 50 <b>NEW</b>	<b>UNIVERSAL SCHUTZBLECH</b> <b>›MUD MAX FLEX F/R ‹</b> <ul style="list-style-type: none"> <li>• für <b>Vorder-</b> oder <b>Hinterrad</b></li> <li>• universell passend für <b>26" - 29"</b></li> <li>• <b>strapazierfähiger</b> und <b>flexibler Kunststoff</b></li> <li>• <b>werkzeuglose Befestigung</b> an der <b>Gabel</b> oder durch Zuschneiden einfache Anbringung am <b>Sattelgestell</b></li> <li>• Länge: 325 mm</li> <li>• inkl. 4 Kabelbinder</li> <li>• auf M-Wave Eurolochkarte</li> </ul>	<b>UNIVERSAL MUDGUARD</b> <b>›MUD MAX FLEX F/R ‹</b> <ul style="list-style-type: none"> <li>• <b>front</b> or <b>rear</b></li> <li>• universal type for <b>26" - 29"</b></li> <li>• <b>hard-wearing</b> and <b>flexible plastic</b></li> <li>• <b>toolless attachment</b> to the <b>fork</b> or easy attachment to the <b>saddle rails</b> by cutting to size</li> <li>• length: 325 mm</li> <li>• incl. 4 cable ties</li> <li>• on M-Wave eurohole card</li> </ul>	<div style="display: flex; align-items: center;"> <div style="border: 1px solid black; padding: 2px; margin-right: 10px;">2 IN 1</div>   </div>    
<b>385052</b> 250	<b>UNIVERSAL SCHUTZBLECH</b> <b>›MUD MAX FLEX F/R ‹</b> <ul style="list-style-type: none"> <li>• für <b>Vorder-</b> oder <b>Hinterrad</b></li> <li>• <b>strapazierfähiger</b> und <b>flexibler Kunststoff</b></li> <li>• zur Befestigung an <b>Gabel</b> und <b>Sitzrohrstreben</b></li> <li>• <b>werkzeuglose</b> Montage</li> <li>• universell passend für fast alle Fahrräder</li> <li>• inkl. 4 Kabelbinder</li> <li>• auf M-Wave Eurolochkarte</li> </ul>	<b>UNIVERSAL MUDGUARD</b> <b>›MUD MAX FLEX F/R ‹</b> <ul style="list-style-type: none"> <li>• for <b>front</b> or <b>rear</b></li> <li>• <b>hard-wearing</b> and <b>flexible plastic</b></li> <li>• for attachment to <b>fork</b> and <b>seat stays</b></li> <li>• <b>toolless</b> mounting</li> <li>• universally suitable for almost all bikes</li> <li>• incl. 4 cable ties</li> <li>• on M-Wave eurohole card</li> </ul>	 
<b>385051</b> 300	<b>UNIVERSAL SCHUTZBLECH</b> <b>›MUD MAX FLEX R ‹</b> <ul style="list-style-type: none"> <li>• für <b>Hinterrad</b></li> <li>• <b>strapazierfähiger</b> und <b>flexibler Kunststoff</b></li> <li>• besserer Schutz durch <b>Verlängerung</b></li> <li>• zur Schnellbefestigung am Sattelgestell</li> <li>• <b>werkzeuglose</b> Montage</li> <li>• universell passend für fast alle Fahrräder</li> <li>• nur <b>18 g</b></li> <li>• auf M-Wave Eurolochkarte</li> </ul>	<b>UNIVERSAL MUDGUARD</b> <b>›MUD MAX FLEX R ‹</b> <ul style="list-style-type: none"> <li>• for <b>rear</b></li> <li>• <b>hard-wearing</b> and <b>flexible plastic</b></li> <li>• better protection through <b>extension</b></li> <li>• for fast attachment to saddle rails</li> <li>• <b>toolless</b> mounting</li> <li>• universally suitable for almost all bikes</li> <li>• only <b>18 g</b></li> <li>• on M-Wave eurohole card</li> </ul>	 
<b>NEW</b>	<b>SCHUTZBLECH FÜR SATTEL- GESTELL</b> <ul style="list-style-type: none"> <li>• zur <b>werkzeuglosen</b> Schnellbefestigung am Sattelgestell</li> <li>• universell passend für <b>26" - 29"</b></li> <li>• <b>Winkel verstellbar</b></li> <li>• auf M-Wave Eurolochkarte</li> </ul> <b>385134</b> ›MUD MAX SEAT LONG ‹ 40 <ul style="list-style-type: none"> <li>• nur 74 g</li> <li>• max. Reifenbreite: 75 mm</li> </ul> <b>385139</b> ›MUD MAX SEAT SHORT ‹ 30 <ul style="list-style-type: none"> <li>• nur 105 g</li> <li>• max. Reifenbreite: 125 mm</li> </ul>	<b>MUDGUARD FOR SADDLE RAILS</b> <ul style="list-style-type: none"> <li>• for fast <b>toolless</b> attachment to saddle rails</li> <li>• universal type for <b>26" - 29"</b></li> <li>• <b>angle adjustable</b></li> <li>• on M-Wave eurohole card</li> </ul> <b>›MUD MAX SEAT LONG ‹</b> <ul style="list-style-type: none"> <li>• only 74 g</li> <li>• max. tire width: 75 mm</li> </ul> <b>›MUD MAX SEAT SHORT ‹</b> <ul style="list-style-type: none"> <li>• only 105 g</li> <li>• max. tire width: 125 mm</li> </ul>	<div style="display: flex; align-items: center;">   </div>   

ART.-NR.	BESCHREIBUNG	DESCRIPTION	
	<b>SCHUTZBLECH-SET ›MUD MAX RACE QR‹ 28"</b> <ul style="list-style-type: none"> <li>für Vorder- und Hinterrad</li> <li><b>flexibles</b> Kunststoffschutzblech</li> <li>mit <b>Schnellverschlüssen</b> (Art. 385098) zur <b>werkzeuglosen</b> Montage an den Sitzrohrstreben/Gabelscheidern</li> <li>mit <b>längenverstellbarer</b> Strebenbefestigung aus <b>Nirosta</b></li> <li>auf M-Wave Eurolochkarte</li> </ul>	<b>MUDGUARD SET ›MUD MAX RACE QR‹ 28"</b> <ul style="list-style-type: none"> <li>front and rear</li> <li><b>flexible</b> plastic mudguard</li> <li>with <b>quick releases</b> (art. 385098) for <b>toolless</b> mounting at the seat stays/fork legs</li> <li>with <b>length adjustable stainless steel</b> safety stays</li> <li>on M-Wave eurohole card</li> </ul>	
<b>385061</b>	Breite <b>33 mm</b> mit <b>abnehmbarem Spritzschutz</b>	width <b>33 mm</b> with <b>removable end</b>	
<b>385081</b>	Breite <b>42 mm</b> 20 set	width <b>42 mm</b>	UVP 49,90 €

	<b>SCHUTZBLECH-SET</b> <ul style="list-style-type: none"> <li>für Vorder- und Hinterrad</li> <li><b>flexibles</b> Kunststoffschutzblech</li> <li>integrierter, <b>2-facher</b>, elektrischer <b>Kontaktstreifen</b></li> <li><b>längenverstellbare Sicherheits-</b>Strebenbefestigung aus <b>Nirosta</b> mit <b>2 cm Verstellbereich</b></li> <li><b>Sicherheitsenden</b></li> <li>inklusive 2 Anschlusslichtkabeln</li> </ul>	<b>MUDGUARD SET</b> <ul style="list-style-type: none"> <li>front and rear</li> <li><b>flexible</b> plastic mudguard</li> <li>integrated, <b>double</b>, electrical <b>contact</b></li> <li><b>length adjustable stainless steel</b> safety stays with <b>2 cm variability</b></li> <li><b>safety ends</b></li> <li>incl. 2 dynamo cables</li> </ul>	<b>VERY FLEXIBLE</b> 
--	--	---	--------------------------







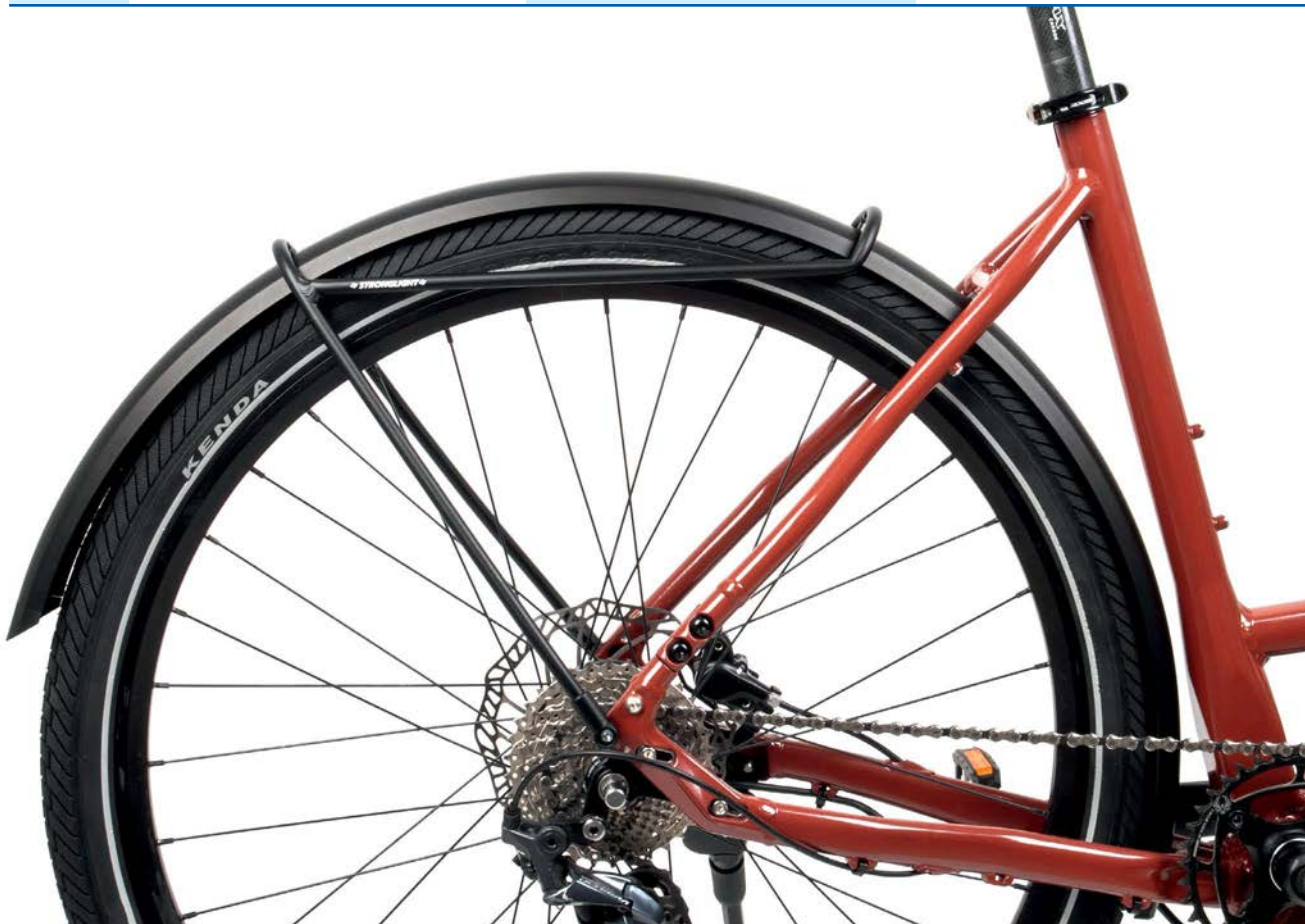





<p><b>M-Wave Verpackung / M-Wave packaging</b></p>	<p>Art. 386118 Art. 386191/2 Art. 386108 <b>schwarz / black</b></p>	<p>Art. 386118 Art. 386191/2 Art. 386108 <b>silber / silver</b></p>		
	in M-Wave Verpackung in M-Wave packaging	Set im Polybeutel set in PE bag	in M-Wave Verpackung in M-Wave packaging	Set im Polybeutel set in PE bag
<b>20"</b> Breite/width <b>56 mm</b>	<b>386170</b> 20 set	<b>386110</b> 40 set		
<b>24"</b> Breite/width <b>56 mm</b>	<b>386171</b> 20 set	<b>386117</b> 30 set		
<b>26"</b> Breite/width <b>60 mm</b>	<b>386172</b> 20 set	<b>386104</b> 20 set	<b>386173</b> 20 set	<b>386107</b> 20 set
<b>27,5"</b> Breite/width <b>60 mm</b>	<b>386178</b> 20 set	<b>386180</b> 20 set		
<b>28"</b> Breite/width <b>45 mm</b>	<b>386174</b> 20 set	<b>386105</b> 30 set	<b>386175</b> 20 set	<b>386106</b> 30 set
<b>28"/29"</b> Breite/width <b>56 mm</b>	<b>386176</b> 20 set	<b>386115</b> 20 set	<b>386177</b> 20 set	<b>386116</b> 20 set
<b>29"</b> Breite/width <b>60 mm</b>	<b>386179</b> 20 set	<b>386181</b> 20 set		
<b>UVP</b>	27,90 €	27,90 €	27,90 €	27,90 €

<b>389992</b>	<b>AUFPREIS SCHUTZBLECHE</b> <ul style="list-style-type: none"> <li>für farbigen Mittelstreifen</li> <li>erhältlich für Art. 386104-7, 386110, 386115-7, ...</li> </ul>	<b>UPCHARGE MUDGUARDS</b> <ul style="list-style-type: none"> <li>for coloured middle strip</li> <li>available for art. 386104-7, 386110, 386115-7, ...</li> </ul>	
---------------	---	---	--

ART.-NR.	BESCHREIBUNG	DESCRIPTION	
<p><b>NEW</b></p>	<p><b>SCHUTZBLECH</b></p> <ul style="list-style-type: none"> <li>• Aluminium</li> <li>• für E-Bikes GEN2 und Urban Light MUC.T.al, MUC.L.al, MRC.G.al</li> <li>• zur Montage mit Gepäckträgern Art. 446100/1/3</li> <li>• mit vorgebohrten Löchern auf Innenprofil</li> <li>• Montageverpackung</li> </ul> <p><b>59 mm</b></p> <p><b>386230</b> Montage in Verbindung mit Art. 446100/1/3</p> <p><b>386231</b> mit längenverstellbaren Zusatzstreben für Montage ohne Gepäckträger (20 mm Verstellbereich)</p> <p><b>69 mm</b></p> <p><b>386234</b> Montage in Verbindung mit Art. 446100/1</p> <p><b>386233</b> mit längenverstellbaren Zusatzstreben für Montage ohne Gepäckträger (20 mm Verstellbereich)</p>	<p><b>MUDGUARD</b></p> <ul style="list-style-type: none"> <li>• aluminium</li> <li>• for e-bikes GEN2 and Urban Light MUC.T.al, MUC.L.al, MRC.G.al</li> <li>• for mounting with rear carriers art. 446100/1/3</li> <li>• with pre-drilled holes on the inside on inner profile</li> <li>• OEM</li> </ul> <p><b>59 mm</b></p> <p>for mounting in relation to art. 446100/1/3 UVP 69,99 €</p> <p>with adjustable stays for mounting without carrier (20 mm variability) UVP 74,99 €</p> <p><b>69 mm</b></p> <p>for mounting in relation to art. 446100/1 UVP 64,99 €</p> <p>with adjustable stays for mounting without carrier (20 mm variability) UVP 69,99 €</p>	  



# SCHUTZBLECH-ZUBEHÖR MUDGUARD ACCESSORIES

ART.-NR. 	BESCHREIBUNG	DESCRIPTION	
<b>386108</b> 1.000/100	<b>SCHUTZBLECH-ZUBEHÖR</b> <b>Universal-Halter</b> zum Befestigen von Streben für Schutzbleche an Befestigungsösen, mit <b>2 cm Verstellbereich</b>	<b>MUDGUARD ACCESSORIES</b> <b>universal bracket</b> for adjusting stays of mudguards to fixing lugs, with <b>2 cm variability</b>	
<b>386185</b> 2.000/100	<b>Winkel</b> zur Montage von Schutzblechstreben an einer <b>Federgabel</b> <b>Edelstahl</b>	<b>angle bracket</b> for mounting of mudguard stays to a <b>suspension fork</b> <b>stainless steel</b>	
<b>386118</b> 1.000/10	<b>Halteclip</b> , mit Befestigungsschraube, für Schutzblechstreben am Schutzblech, passend für Art. 386110, ...	<b>clip</b> , with mounting screw, for mudguard stays on mudguard, suitable for art. 386110, ...	
<b>386191</b> 26"	V-Strebe, <b>Nirosta</b> , ablängbar, inkl. Universalhalter Art. 386108	V-stay, <b>stainless steel</b> , cuttable, incl. universal bracket art. 386108	
<b>386192</b> 100/10	28"	28"	
<b>389999</b> 100 set	<b>KLEIDERSCHUTZ</b> <ul style="list-style-type: none"> <li>für 26" (+28")</li> <li>Kunststoff</li> <li>schwarz</li> <li>mit <b>Universalbefestigungskit</b></li> <li>Ausschnitt <b>individuell anpassbar</b></li> <li>1 Set rechts und links</li> <li>Montageverpackung</li> </ul>	<b>CLOTHING GUARD</b> <ul style="list-style-type: none"> <li>for 26" (+28")</li> <li>plastic</li> <li>black</li> <li>with <b>universal mounting kit</b></li> <li>dynamo holes <b>individually adjustable</b></li> <li>1 set right and left</li> <li>OEM</li> </ul>	
<b>389981</b> schwarz	<b>KLEIDERSCHUTZ</b> <ul style="list-style-type: none"> <li>hochwertiges Spiralgummiwabennetz</li> <li>doppelt geklammert</li> <li>30 (links)/28 (rechts) Haken</li> <li>paarweise im Polybeutel</li> <li>mit Haken für Befestigung am Anlötteil</li> </ul>	<b>CLOTHING GUARD</b> <ul style="list-style-type: none"> <li>high quality spiral rubber comb net</li> <li>double clamped</li> <li>30 (left)/28 (right) hooks</li> <li>one pair in PE bag</li> <li>with clamp for fixing on boss</li> </ul>	
<b>389980</b> 150 pair  Weitere Farben auf Anfrage erhältlich.	braun	brown  Other colours on request.	   



# RIMS



ART.-NR.	BESCHREIBUNG	DESCRIPTION	
<b>ROAD</b>			
	<b>FELGE ›R4022‹</b> <ul style="list-style-type: none"> <li>Aluminium Hohlkammerfelge</li> <li><b>622 x 15</b></li> <li>Felgenhöhe 40 mm</li> <li>32 Loch</li> <li>mit Verschleißanzeige</li> <li><b>CNC aufgeraute Bremsflanken (GBS)</b></li> <li>für FV</li> <li>ERD: 559 mm</li> </ul>	<b>RIM ›R4022‹</b> <ul style="list-style-type: none"> <li>aluminium hollow section rim</li> <li><b>622 x 15</b></li> <li>rim height 40 mm</li> <li>32 hole</li> <li>with wearout indicator</li> <li><b>CNC grooved braking sides (GBS)</b></li> <li>for FV</li> <li>ERD: 559 mm</li> </ul>	 
• 381040	schwarz	black	UVP 28,90 €
• 381041	silber	silver	UVP 28,90 €
• 381042	weiß	white	UVP 28,90 €
• 381048	pink	pink	UVP 24,90 €
10			<p>Tested by the manufacturer based on ISO 4210</p> 
	<b>FELGE ›ALCYON‹</b> <ul style="list-style-type: none"> <li><b>622 x 14</b></li> <li><b>CNC aufgeraute Bremsflanken (GBS)</b></li> <li>aus extrem steifem <b>6082 Aluminium</b></li> <li><b>SCR</b> = verstärkte Flanken, verhindert Felgenrisse durch Abnutzung</li> <li><b>AHD</b> = angewinkelt gebohrte Löcher</li> <li>schwarz</li> <li>nur <b>420 g</b></li> <li>für FV</li> <li>ERD: 592 mm</li> </ul>	<b>RIM ›ALCYON‹</b> <ul style="list-style-type: none"> <li><b>622 x 14</b></li> <li><b>CNC grooved braking sides (GBS)</b></li> <li>made of extremely stiff <b>6082 aluminium</b></li> <li><b>SCR</b> = reinforced sides, avoid split rims caused by abrasion</li> <li><b>AHD</b> = angular hole drilling</li> <li>black</li> <li>only <b>420 g</b></li> <li>for FV</li> <li>ERD: 592 mm</li> </ul>	 <p>420 g</p>  
380265	32 Loch	32 hole	UVP 41,90 €
380263	24 Loch	24 hole	UVP 33,90 €
380260	20 Loch	20 hole	UVP 33,90 €
15			
380215	<b>FELGE ›TAURUS‹</b> <ul style="list-style-type: none"> <li><b>622 x 14</b></li> <li><b>CNC aufgeraute Bremsflanken (GBS)</b></li> <li><b>SCR</b> = verstärkte Flanken, verhindert Felgenrisse durch Abnutzung</li> <li>mit Verschleißanzeige</li> <li>nur 540 g</li> <li>silber eloxiert</li> <li>36 Loch</li> <li>für FV</li> <li>ERD: 583 mm</li> </ul>	<b>RIM ›TAURUS‹</b> <ul style="list-style-type: none"> <li><b>622 x 14</b></li> <li><b>CNC grooved braking sides (GBS)</b></li> <li><b>SCR</b> = reinforced sides avoid split rims caused by abrasion</li> <li>with wearout indicator</li> <li>only 540 g</li> <li>silver anodized</li> <li>36 hole</li> <li>for FV</li> <li>ERD: 583 mm</li> </ul>	 
15			 <p>UVP 26,90 €</p>

ART.-NR.	BESCHREIBUNG	DESCRIPTION	ERD = Effective Rim Diameter ERD = maßgeblicher Felgendurchmesser
<b>DISC</b>			
 <b>2</b> 140 kg	<b>MTB DISC FELGE ›E35‹</b> <ul style="list-style-type: none"> <li>• <b>Nirosta-Ösen</b></li> <li>• asymmetrisches Profil</li> <li>• <b>35 mm</b> Innenbreite</li> <li>• <b>tubeless</b> ready</li> <li>• nur 608 g</li> <li>• 32 Loch</li> <li>• schwarz</li> <li>• für FV</li> <li>• max. Belastbarkeit <b>140 kg</b></li> </ul>	<b>MTB DISC RIM ›E35‹</b> <ul style="list-style-type: none"> <li>• <b>stainless steel eyelets</b></li> <li>• asymmetric profile</li> <li>• <b>35 mm</b> inner width</li> <li>• <b>tubeless</b> ready</li> <li>• only 608 g</li> <li>• 32 hole</li> <li>• black</li> <li>• for FV</li> <li>• max. load capacity <b>140 kg</b></li> </ul>	
<b>381802</b> <b>381800</b> 28	<b>622 x 35, ERD: 597 mm</b> <b>584 x 35, ERD: 556 mm</b>	<b>622 x 35, ERD: 597 mm</b> <b>584 x 35, ERD: 556 mm</b>	UVP 41,90 €
 <b>2</b> 140 kg	<b>MTB DISC FELGE ›SPORT DISC‹</b> <ul style="list-style-type: none"> <li>• <b>622 x 23</b></li> <li>• <b>Nirosta-Ösen</b></li> <li>• <b>23 mm</b> Innenbreite</li> <li>• <b>tubeless</b> ready</li> <li>• nur 465 g</li> <li>• 32 Loch</li> <li>• ERD: 589 mm</li> <li>• schwarz</li> <li>• für FV</li> <li>• max. Belastbarkeit <b>140 kg</b></li> </ul>	<b>MTB DISC RIM ›SPORT DISC‹</b> <ul style="list-style-type: none"> <li>• <b>622 x 23</b></li> <li>• <b>stainless steel eyelets</b></li> <li>• <b>23 mm</b> inner width</li> <li>• <b>tubeless</b> ready</li> <li>• only 465 g</li> <li>• 32 hole</li> <li>• ERD: 589 mm</li> <li>• black</li> <li>• for FV</li> <li>• max. load capacity <b>140 kg</b></li> </ul>	  <b>465 g</b>
<b>381801</b> 16	<b>622 x 23</b> <b>622 x 23</b>	<b>622 x 23</b> <b>622 x 23</b>	UVP 39,90 €
 <b>2</b> 140 kg	<b>ENDURO DISC FELGE ›4.30‹</b> <ul style="list-style-type: none"> <li>• <b>622 x 30</b></li> <li>• aus extrem steifem <b>6005 Aluminium</b></li> <li>• <b>Nirosta-Ösen</b></li> <li>• <b>30 mm</b> Innenbreite</li> <li>• <b>tubeless</b> ready</li> <li>• <b>Inner-Hump-Technologie: speziell konstruiertes Felgenprofil</b> hält den Reifen auch bei Druckverlust länger auf der Felge</li> <li>• nur 560 g</li> <li>• 32 Loch</li> <li>• ERD: 598 mm</li> <li>• schwarz eloxiert</li> <li>• für FV</li> <li>• max. Belastbarkeit <b>140 kg</b></li> </ul>	<b>ENDURO DISC RIM ›4.30‹</b> <ul style="list-style-type: none"> <li>• <b>622 x 30</b></li> <li>• made of extremely stiff <b>6005 aluminium</b></li> <li>• <b>stainless steel eyelets</b></li> <li>• <b>30 mm</b> inner width</li> <li>• <b>tubeless</b> ready</li> <li>• <b>Inner-Hump-Technology: a specially constructed rim profile</b> keeps the tire longer on the rim also in case of pressure loss</li> <li>• only 560 g</li> <li>• 32 hole</li> <li>• ERD: 598 mm</li> <li>• black anodised</li> <li>• for FV</li> <li>• max. load capacity <b>140 kg</b></li> </ul>	  <b>560 g</b> <b>PLUS</b>  <b>INNER HUMP TECHNOLOGY</b>
<b>380467</b> 10	<b>622 x 30</b> <b>622 x 30</b>	<b>622 x 30</b> <b>622 x 30</b>	UVP 51,90 €
 <b>2</b> 140 kg	<b>ENDURO DISC FELGE ›RX 2027 TL-PLUS‹</b> <ul style="list-style-type: none"> <li>• aus extrem steifem <b>6005 Aluminium</b></li> <li>• <b>Nirosta-Ösen</b></li> <li>• <b>27 mm</b> Innenbreite</li> <li>• <b>tubeless</b> ready</li> <li>• <b>Inner-Hump-Technologie: speziell konstruiertes Felgenprofil</b> hält den Reifen auch bei Druckverlust länger auf der Felge</li> <li>• 32 Loch</li> <li>• schwarz eloxiert</li> <li>• für FV</li> <li>• max. Belastbarkeit <b>130 kg</b></li> </ul>	<b>ENDURO DISC RIM ›RX 2027 TL-PLUS‹</b> <ul style="list-style-type: none"> <li>• made of extremely stiff <b>6005 aluminium</b></li> <li>• <b>stainless steel eyelets</b></li> <li>• <b>27 mm</b> inner width</li> <li>• <b>tubeless</b> ready</li> <li>• <b>Inner-Hump-Technology: a specially constructed rim profile</b> keeps the tire longer on the rim also in case of pressure loss</li> <li>• 32 hole</li> <li>• black anodised</li> <li>• for FV</li> <li>• max. load capacity <b>130 kg</b></li> </ul>	  <b>474 g</b> <b>PLUS</b>  <b>INNER HUMP TECHNOLOGY</b>
<b>380480</b> <b>380481</b> 12	<b>622 x 27, nur 502 g</b> ERD: 596 mm <b>584 x 27, nur 474 g</b> ERD: 557 mm	<b>622 x 27, only 502 g</b> ERD: 596 mm <b>584 x 27, only 474 g</b> ERD: 557 mm	UVP 46,90 € UVP 50,90 €

ART.-NR.	BESCHREIBUNG	DESCRIPTION	
<b>380462</b> 12 <b>NEW</b>	<b>DISC FELGE ›E-ROCKY‹</b> <ul style="list-style-type: none"> <li>• 622 x 25</li> <li>• Nirosta-Ösen</li> <li>• 25 mm Innenbreite</li> <li>• tubeless ready</li> <li>• nur 564 g</li> <li>• 32 Loch</li> <li>• schwarz</li> <li>• für AV</li> <li>• ERD: 596 mm</li> <li>• max. Belastbarkeit <b>120 kg</b></li> </ul>	<b>DISC RIM ›E-ROCKY‹</b> <ul style="list-style-type: none"> <li>• 622 x 25</li> <li>• stainless steel eyelets</li> <li>• 25 mm inner width</li> <li>• tubeless ready</li> <li>• only 564 g</li> <li>• 32 hole</li> <li>• black</li> <li>• for AV</li> <li>• ERD: 596 mm</li> <li>• max. load capacity <b>120 kg</b></li> </ul>	
<b>380466</b> 15	<b>DISC FELGE ›2.19‹</b> <ul style="list-style-type: none"> <li>• 622 x 19</li> <li>• aus extrem steifem <b>6005 Aluminium</b></li> <li>• Nirosta-Ösen</li> <li>• 32 Loch</li> <li>• für AV</li> <li>• schwarz eloxiert</li> <li>• ERD: 598 mm</li> </ul>	<b>DISC RIM ›2.19‹</b> <ul style="list-style-type: none"> <li>• 622 x 19</li> <li>• made of extremely stiff <b>6005 aluminium</b></li> <li>• stainless steel eyelets</li> <li>• 32 hole</li> <li>• for AV</li> <li>• black anodised</li> <li>• ERD: 598 mm</li> </ul>	
<b>380463</b> <b>380450</b>  <b>380451</b>  <b>380452</b> 15	<b>DISC FELGE ›TOP DISC‹</b> <ul style="list-style-type: none"> <li>• Nirosta-Ösen</li> <li>• aus 6005 T6 Aluminium</li> <li>• schwarz eloxiert</li> <li>• für AV</li> </ul> <p>622 x 19, nur 522 g, ERD: 598 mm</p> <p>36 Loch</p> <p>32 Loch</p> <p>584 x 19, nur 490 g, 32 Loch, ERD: 559 mm</p> <p>559 x 19, nur 470 g, 32 Loch, ERD: 534 mm</p>	<b>DISC RIM ›TOP DISC‹</b> <ul style="list-style-type: none"> <li>• stainless steel eyelets</li> <li>• made of 6005 T6 aluminium</li> <li>• black anodised</li> <li>• for AV</li> </ul> <p>622 x 19, only 522 g, ERD: 598 mm</p> <p>36 hole</p> <p>32 hole</p> <p>584 x 19, only 490 g, 32 hole, ERD: 559 mm</p> <p>559 x 19, only 470 g, 32 hole, ERD: 534 mm</p>	
<b>381150</b>  <b>381151</b> 10	<b>DISC FELGE ›VENTURA DOUBLE DISC 24 PLUS‹</b> <ul style="list-style-type: none"> <li>• 6082 T6 Aluminium</li> <li>• 32 Loch</li> <li>• schwarz</li> <li>• für AV</li> </ul> <p>622 x 24, nur 470 g ERD: 594 mm</p> <p>584 x 24, nur 440 g ERD: 555 mm</p>	<b>DISC RIM ›VENTURA DOUBLE DISC 24 PLUS‹</b> <ul style="list-style-type: none"> <li>• 6082 T6 aluminium</li> <li>• 32 hole</li> <li>• black</li> <li>• for AV</li> </ul> <p>622 x 24, only 470 g ERD: 594 mm</p> <p>584 x 24, only 440 g ERD: 555 mm</p>	



ART.-NR.	BESCHREIBUNG	DESCRIPTION	
	<b>DISC FELGE ›VENTURA DOUBLE DISC 19‹</b> <ul style="list-style-type: none"> <li>• 6061 T6 Aluminium</li> <li>• 36 Loch</li> <li>• schwarz</li> <li>• für AV</li> </ul>	<b>DISC RIM ›VENTURA DOUBLE DISC 19‹</b> <ul style="list-style-type: none"> <li>• 6061 T6 aluminium</li> <li>• 36 hole</li> <li>• black</li> <li>• for AV</li> </ul>	
• <b>381100</b> • <b>381101</b> 10	<b>622 x 19</b> ERD: 599 mm  <b>584 x 19</b> ERD: 560 mm	<b>622 x 19</b> ERD: 599 mm  <b>584 x 19</b> ERD: 560 mm	
			UVP 24,90 €

## BREMSFLANKEN BRAKING SIDES

	<b>FELGE ›DRAGON L-719‹</b> <ul style="list-style-type: none"> <li>• <b>CNC aufgeraute Bremsflanken (GBS)</b></li> <li>• <b>SCR</b> = verstärkte Flanken, verhindert Felgenrisse durch Abnutzung</li> <li>• <b>Nirosta-Ösen</b></li> <li>• mit Verschleißanzeige</li> <li>• für AV</li> </ul>	<b>RIM ›DRAGON L-719‹</b> <ul style="list-style-type: none"> <li>• <b>CNC grooved braking sides (GBS)</b></li> <li>• <b>SCR</b> = reinforced sides avoid split rims caused by abrasion</li> <li>• <b>stainless steel eyelets</b></li> <li>• with wearout indicator</li> <li>• for AV</li> </ul>	
<b>380275</b> <b>380331</b> <b>380333</b>  <b>380337</b>   <b>380270</b> <b>380330</b> <b>380272</b> 15	<b>622 x 19</b> ERD: 598 mm  <b>36 Loch</b> , silber eloxiert  <b>36 Loch</b> , schwarz eloxiert  <b>32 Loch</b> , schwarz eloxiert  <b>584 x 19</b> ERD: 561 mm <b>32 Loch</b> , schwarz eloxiert   <b>559 x 19</b> ERD: 535 mm  <b>36 Loch</b> , silber eloxiert  <b>36 Loch</b> , schwarz eloxiert  <b>32 Loch</b> , schwarz eloxiert	<b>622 x 19</b> ERD: 598 mm  <b>36 hole</b> , silver anodized  <b>36 hole</b> , black anodized  <b>32 hole</b> , black anodized  <b>584 x 19</b> ERD: 561 mm <b>32 hole</b> , black anodized   <b>559 x 19</b> ERD: 535 mm  <b>36 hole</b> , silver anodized  <b>36 hole</b> , black anodized  <b>32 hole</b> , black anodized	

<b>380250</b> 15	<b>FELGE ›RMX-2021 SCR‹</b> <ul style="list-style-type: none"> <li>• mit <b>Verschleißanzeige</b></li> <li>• silber</li> <li>• 36 Loch</li> <li>• für AV</li> </ul>	<b>RIM ›RMX-2021 SCR‹</b> <ul style="list-style-type: none"> <li>• with <b>wearout indicator</b></li> <li>• silver</li> <li>• 36 hole</li> <li>• for AV</li> </ul>	
	<b>559 x 21</b> ERD: 541 mm	<b>559 x 21</b> ERD: 541 mm	UVP 13,90 €

ART.-NR.	BESCHREIBUNG	DESCRIPTION	
	<b>FELGE ›VENTURA DOUBLE‹</b>	<b>RIM ›VENTURA DOUBLE‹</b>	<b>VENTURA®</b> BIKE + OUTDOOR
	<ul style="list-style-type: none"> <li>• mit Verschleißanzeige</li> <li>• CNC aufgeraute Bremsflanken (GBS)</li> <li>• für AV</li> <li>• schwarz</li> </ul>	<ul style="list-style-type: none"> <li>• with wearout indicator</li> <li>• CNC grooved braking sides (GBS)</li> <li>• for AV</li> <li>• black</li> </ul>	
	<b>36 Loch</b>	<b>36 hole</b>	
• 381025	<b>622 x 19</b> ERD: 603 mm	<b>622 x 19</b> ERD: 603 mm	UVP 23,90 €
• 381016	<b>584 x 19</b> ERD: 560 mm	<b>584 x 19</b> ERD: 560 mm	UVP 23,90 €
• 381010	<b>559 x 19</b> ERD: 537 mm	<b>559 x 19</b> ERD: 537 mm	UVP 21,90 €
	<b>32 Loch</b>	<b>32 hole</b>	
• 381011	<b>559 x 19</b> ERD: 537 mm	<b>559 x 19</b> ERD: 537 mm	UVP 19,90 €
10			

## FAT

## FAT

380938	<b>FAT TIRE / SNOWBIKE FELGE</b>	<b>FAT TIRE / SNOWBIKE RIM</b>	
4	<ul style="list-style-type: none"> <li>• 559 x 73</li> <li>• 80 mm breit</li> <li>• 36 Loch</li> <li>• für AV</li> <li>• schwarz</li> <li>• ERD: 530 mm</li> </ul>	<ul style="list-style-type: none"> <li>• 559 x 73</li> <li>• width 80 mm</li> <li>• 36 hole</li> <li>• for AV</li> <li>• black</li> <li>• ERD: 530 mm</li> </ul>	
			UVP 61,90 €
381091	<b>FAT TIRE / SNOWBIKE FELGE</b>	<b>FAT TIRE / SNOWBIKE RIM</b>	
4	<ul style="list-style-type: none"> <li>• 507 x 96</li> <li>• 102 mm breit</li> <li>• 32 Loch</li> <li>• für AV/DV/FV</li> <li>• schwarz</li> <li>• ERD: 492 mm</li> </ul>	<ul style="list-style-type: none"> <li>• 507 x 96</li> <li>• width 102 mm</li> <li>• 32 hole</li> <li>• for AV/DV/FV</li> <li>• black</li> <li>• ERD: 492 mm</li> </ul>	
			UVP 37,90 €

# PROMAX



# N

**NOVATEC**<sup>®</sup>  
QUALITY • PERFORMANCE • RELIABILITY

## READY TO RACE

Leicht, schnell und steif. Sicher, robust und komfortabel. Die Anforderungen, die an Laufräder gestellt werden sind enorm.











Novatec schafft den Spagat und bietet durch die Bank Laufräder, die ein hochattraktives Verhältnis von Preis und Leistung anbieten. Als Technologieführer ist es selbstverständlich, dass Novatec seine eigene Topmodellnabe verbaut. Spitzensportler aus den unterschiedlichsten Disziplinen setzen seit Jahren auf die Laufräder von Novatec.

Light, fast and stiff. Safe, robust and comfortable. The requirements on wheels which are demanded are enormous.

Novatec can build the bridge and offers different wheels, which have an attractive price-performance ratio. It goes without saying that technology leader Novatec installs their own top-of-the-range hubs. Top athletes participating in different disciplines have been counting on wheels of Novatec for years.



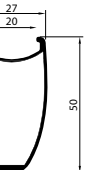

ART.-NR. 	BESCHREIBUNG	DESCRIPTION	
<p><b>384125</b></p> <p>1 set</p> 	<p><b>LAUFRADSATZ ›R9 U3.0‹</b></p> <p><b>Naben:</b></p> <ul style="list-style-type: none"> <li>• mit <b>Titan</b>-Schnellspannern</li> <li>• <b>Aluminium</b>-Dichtungsscheiben</li> </ul> <p><b>vorne:</b></p> <ul style="list-style-type: none"> <li>• 2 <b>austauschbare, japanische Industriekugellager</b></li> </ul> <p><b>hinten:</b></p> <ul style="list-style-type: none"> <li>• 4 <b>austauschbare, japanische Industriekugellager</b></li> <li>• für 8/9/10/11-fach Kassette für Shimano oder Sram (Road+MTB)</li> <li>• <b>rot eloxierter, austauschbarer</b> Kassettenskörper (Art. 326297 = Shimano/Sram, Art. 326293 = Sram XD, Art. 326298 = Campagnolo), mit <b>Anti Bite Guard</b></li> </ul> <p><b>Felgen:</b></p> <ul style="list-style-type: none"> <li>• Carbon-Hohlkammerfelge, UD-finish</li> <li>• für <b>Draht-/Kevlarreifen</b></li> <li>• <b>Tubeless ready</b></li> <li>• 700C</li> <li>• Höhe <b>90 mm</b></li> <li>• vorne 16 Loch / hinten 20 Loch</li> </ul> <p><b>Speichen:</b></p> <ul style="list-style-type: none"> <li>• Straight Pull <b>Aero</b>-Speichen</li> <li>• Aluminium Nippel</li> </ul> <p><b>Extras:</b></p> <ul style="list-style-type: none"> <li>• <b>inkl. Bremschuhe</b></li> <li>• <b>inkl. Ventilverlängerung</b></li> <li>• inkl. Ersatzspeichen</li> <li>• inkl. Ersatznippel</li> </ul> <p>max. Fahrergewicht <b>110 kg</b></p>	<p><b>WHEEL SET ›R9 U3.0‹</b></p> <p><b>Hubs:</b></p> <ul style="list-style-type: none"> <li>• with <b>titanium</b> QRs</li> <li>• <b>aluminium</b> side caps</li> </ul> <p><b>front:</b></p> <ul style="list-style-type: none"> <li>• 2 <b>exchangeable, Japanese sealed bearings</b></li> </ul> <p><b>rear:</b></p> <ul style="list-style-type: none"> <li>• 4 <b>exchangeable, Japanese sealed bearings</b></li> <li>• for 8/9/10/11-speed Shimano or Sram cassette (Road+MTB)</li> <li>• <b>red anodized, replaceable</b> cassette body (art. 326297 = Shimano/Sram, art. 326293 Sram XD, art. 326298 = Campagnolo), with <b>Anti Bite Guard</b></li> </ul> <p><b>Rims:</b></p> <ul style="list-style-type: none"> <li>• carbon double wall, UD finish</li> <li>• for <b>clinchers/Kevlar tires</b></li> <li>• <b>tubeless ready</b></li> <li>• 700C</li> <li>• height <b>90 mm</b></li> <li>• front 16 hole / rear 20 hole</li> </ul> <p><b>Spokes:</b></p> <ul style="list-style-type: none"> <li>• straight pull <b>aero</b> spokes</li> <li>• aluminium nipples</li> </ul> <p><b>Extras:</b></p> <ul style="list-style-type: none"> <li>• <b>incl. brake shoes</b></li> <li>• <b>incl. valve extender</b></li> <li>• incl. replacement spokes</li> <li>• incl. replacement nipples</li> </ul> <p>max. riders weight <b>110 kg</b></p> <p>UVP 1.799,00 €</p>	<p>Tested by the manufacturer based on ISO 4210</p> <p><b>TUBELESS READY</b></p>   <p>880 g</p>   <p>1.060 g</p>
<p><b>384126</b></p> <p>1 set</p>  	<p><b>LAUFRADSATZ ›R5 U3.0‹</b></p> <p><b>Naben:</b></p> <ul style="list-style-type: none"> <li>• mit <b>Titan</b>-Schnellspannern</li> <li>• <b>Aluminium</b>-Dichtungsscheiben</li> </ul> <p><b>vorne:</b></p> <ul style="list-style-type: none"> <li>• 2 <b>austauschbare, japanische Industriekugellager</b></li> </ul> <p><b>hinten:</b></p> <ul style="list-style-type: none"> <li>• 4 <b>austauschbare, japanische Industriekugellager</b></li> <li>• für 8/9/10/11-fach Kassette für Shimano oder Sram (Road+MTB)</li> <li>• <b>rot eloxierter, austauschbarer</b> Kassettenskörper (Art. 326297 = Shimano/Sram, Art. 326293 = Sram XD, Art. 326298 = Campagnolo), mit <b>Anti Bite Guard</b></li> </ul> <p><b>Felgen:</b></p> <ul style="list-style-type: none"> <li>• Carbon-Hohlkammerfelge, UD-finish</li> <li>• <b>Tubeless ready</b></li> <li>• 700C</li> <li>• Höhe <b>50 mm</b></li> <li>• vorne 20 Loch / hinten 24 Loch</li> <li>• für Drahtreifen</li> </ul> <p><b>Speichen:</b></p> <ul style="list-style-type: none"> <li>• Straight Pull <b>Aero</b>-Speichen</li> <li>• Aluminium Nippel</li> </ul> <p><b>Extras:</b></p> <ul style="list-style-type: none"> <li>• <b>inkl. Bremschuhe</b></li> <li>• <b>inkl. Ventilverlängerung</b></li> <li>• inkl. Ersatzspeichen</li> <li>• inkl. Ersatznippel</li> </ul> <p>max. Fahrergewicht <b>110 kg</b></p>	<p><b>WHEEL SET ›R5 U3.0‹</b></p> <p><b>Hubs:</b></p> <ul style="list-style-type: none"> <li>• with <b>titanium</b> QRs</li> <li>• <b>aluminium</b> side caps</li> </ul> <p><b>front:</b></p> <ul style="list-style-type: none"> <li>• 2 <b>exchangeable, Japanese sealed bearings</b></li> </ul> <p><b>rear:</b></p> <ul style="list-style-type: none"> <li>• 4 <b>exchangeable, Japanese sealed bearings</b></li> <li>• for 8/9/10/11-speed Shimano or Sram cassette (Road+MTB)</li> <li>• <b>red anodized, replaceable</b> cassette body (art. 326297 = Shimano/Sram, art. 326293 = Sram XD, art. 326298 = Campagnolo), with <b>Anti Bite Guard</b></li> </ul> <p><b>Rims:</b></p> <ul style="list-style-type: none"> <li>• carbon double wall, UD finish</li> <li>• <b>tubeless ready</b></li> <li>• 700C</li> <li>• height <b>50 mm</b></li> <li>• front 20 hole / rear 24 hole</li> <li>• for clinchers</li> </ul> <p><b>Spokes:</b></p> <ul style="list-style-type: none"> <li>• straight pull <b>aero</b> spokes</li> <li>• aluminium nipples</li> </ul> <p><b>Extras:</b></p> <ul style="list-style-type: none"> <li>• <b>incl. brake shoes</b></li> <li>• <b>incl. valve extender</b></li> <li>• incl. replacement spokes</li> <li>• incl. replacement nipples</li> </ul> <p>max. riders weight <b>110 kg</b></p> <p>UVP 1.763,00 €</p>	<p>Tested by the manufacturer based on ISO 4210</p> <p><b>UCI APPROVED</b></p> <p><b>TUBELESS READY</b></p>   <p>758 g</p>   <p>949 g</p>
Gravel/CX	Sprint	Endurance	Aero / Time Trial



ART.-NR.	BESCHREIBUNG	DESCRIPTION
	<b>LAUFRADSATZ ›R3‹</b> <b>Naben:</b> <ul style="list-style-type: none"> <li>• Aluminium-Dichtungsscheiben vorne:</li> <li>• 2 austauschbare, japanische Industriekugellager hinten:</li> <li>• 4 austauschbare, japanische Industriekugellager</li> </ul> <b>Felgen:</b> <ul style="list-style-type: none"> <li>• Carbon-Hohlkammerfelge, UD-finish</li> <li>• Tubeless ready</li> <li>• 700C</li> <li>• Höhe 38 mm</li> <li>• für Drahtreifen</li> </ul> <b>Speichen:</b> <ul style="list-style-type: none"> <li>• Straight Pull Aero-Speichen</li> <li>• schwarze Aluminium-Nippel</li> </ul> max. Fahrergewicht 110 kg	<b>WHEEL SET ›R3‹</b> <b>Hubs:</b> <ul style="list-style-type: none"> <li>• aluminium side caps front:</li> <li>• 2 exchangeable, Japanese sealed bearings rear:</li> <li>• 4 exchangeable, Japanese sealed bearings</li> </ul> <b>Rims:</b> <ul style="list-style-type: none"> <li>• carbon double wall, UD finish</li> <li>• tubeless ready</li> <li>• 700C</li> <li>• height 38 mm</li> <li>• for clinchers</li> </ul> <b>Spokes:</b> <ul style="list-style-type: none"> <li>• straight pull aero spokes</li> <li>• black aluminium nipples</li> </ul> max. riders weight 110 kg
<b>384213</b> <b>NEW</b> 1 set	<b>›R3 CLIN DISC U4.0‹</b> <b>Naben:</b> <ul style="list-style-type: none"> <li>• für Centerlock Brems Scheiben</li> <li>• UD Carbon</li> <li>• Bremsscheibenaufnahme</li> </ul> <b>vorne:</b> <ul style="list-style-type: none"> <li>• Einbaumaß: 12 x 100 mm</li> </ul> <b>hinten:</b> <ul style="list-style-type: none"> <li>• Einbaumaß: 12 x 142 mm</li> <li>• 4 in 1: serienmäßig vorbereitet für 12 x 142 mm-Steckachse, Umrüstset für Schnellspanner 5 mm (Art. 320291), 10 x 135 mm, 12 x 135 mm optional erhältlich</li> <li>• für 10- und 11-fach (Shimano Road und MTB)</li> <li>• umrüstbar auf Sram XD Drive durch Kassettenköper Art. 326293</li> </ul> <b>Felgen:</b> <ul style="list-style-type: none"> <li>• asymmetrisches Felgen-Design damit Speichen auf Zahnkranzseite weniger steil sind</li> <li>• vorne 24 Loch / hinten 24 Loch</li> </ul> <b>Extras:</b> <ul style="list-style-type: none"> <li>• inkl. Ersatzspeichen</li> <li>• inkl. Ersatznippel</li> </ul>	<b>›R3 CLIN DISC U4.0‹</b> <b>Hubs:</b> <ul style="list-style-type: none"> <li>• for centerlock brake discs</li> <li>• UD carbon</li> <li>• disc brake mount</li> </ul> <b>front:</b> <ul style="list-style-type: none"> <li>• OLD front: 12 x 100 mm</li> </ul> <b>rear:</b> <ul style="list-style-type: none"> <li>• OLD: 12 x 142 mm</li> <li>• 4 in 1: standard fitted for 12 x 142 mm thru axle, conversion kit for QR 5 mm (art. 320291), 10 x 135 mm, 12 x 135 mm optionally available</li> <li>• for 10 and 11 speed (Shimano Road and MTB)</li> <li>• convertible to Sram XD Drive by cassette body art. 326293</li> </ul> <b>Rims:</b> <ul style="list-style-type: none"> <li>• asymmetric rim design so the spokes are not too steep</li> <li>• front 24 hole / rear 24 hole</li> </ul> <b>Extras:</b> <ul style="list-style-type: none"> <li>• incl. replacement spokes</li> <li>• incl. replacement nipples</li> </ul>
	UVP 1.511,00 €	
	Cyclo Cross	Sprint
	Endurance	Aero / Time Trial

<b>384133</b> 1 set	<b>›R3 U3.0‹</b> <b>Naben:</b> <ul style="list-style-type: none"> <li>• mit Titan-Schnellspannern</li> <li>• Aluminium</li> <li>• Einbaumaß vorne: 100 mm</li> <li>• Einbaumaß hinten: 130 mm</li> </ul> <b>hinten:</b> <ul style="list-style-type: none"> <li>• für 8/9/10/11-fach Kassette für Shimano oder Sram (MTB+Road)</li> <li>• rot eloxierter, austauschbarer Kassettenkörper (Art. 326297 = Shimano/Sram, Art. 326293 = Sram XD, Art. 326298 = Campagnolo), mit Anti Bite Guard</li> </ul> <b>Felgen:</b> <ul style="list-style-type: none"> <li>• vorne 20 Loch / hinten 24 Loch</li> <li>• für Felgenbremsen</li> </ul> <b>Extras:</b> <ul style="list-style-type: none"> <li>• inkl. Bremschuhe</li> <li>• inkl. Ersatzspeichen</li> <li>• inkl. Ersatznippel</li> </ul>	<b>›R3 U3.0‹</b> <b>Hubs:</b> <ul style="list-style-type: none"> <li>• with titanium QRs</li> <li>• aluminium</li> <li>• OLD front: 100 mm</li> <li>• OLD rear: 130 mm</li> </ul> <b>rear:</b> <ul style="list-style-type: none"> <li>• for 8/9/10/11-speed Shimano or Sram cassette (MTB+Road)</li> <li>• red anodized, replaceable cassette body (art. 326297 = Shimano/Sram, art. 326293 = Sram XD, art. 326298 = Campagnolo), with Anti Bite Guard</li> </ul> <b>Rims:</b> <ul style="list-style-type: none"> <li>• front 20 hole / rear 24 hole</li> <li>• for rim brakes</li> </ul> <b>Extras:</b> <ul style="list-style-type: none"> <li>• incl. brake shoes</li> <li>• incl. replacement spokes</li> <li>• incl. replacement nipples</li> </ul>
	UVP 1.399,00 €	
	Cyclo Cross	Sprint
	Endurance	Aero / Time Trial

Tested by the manufacturer based on ISO 4210

**TUBELESS READY**

665 g



813 g

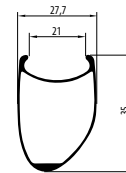







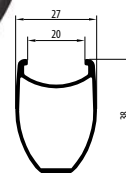



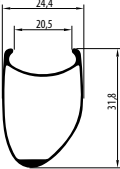

660 g

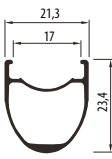

840 g





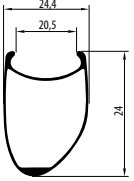

**UCI APPROVED**

ART.-NR.	BESCHREIBUNG	DESCRIPTION					
<p></p> <p><b>384179</b> ›JETFLY DISC U4.0‹ 1 set</p>	<p><b>LAUFRADSATZ 28" ›JETFLY‹</b></p> <p><b>Naben:</b></p> <ul style="list-style-type: none"> <li>• Aluminium-Dichtungsscheiben</li> <li>• 2/4 austauschbare, japanische Industriekugellager</li> <li>• für 8/9/10/11-fach Kassette für Shimano oder Sram (MTB+Road)</li> <li>• rot eloxierter, austauschbarer Aluminium Kassettenkörper (Art. 326297 = Shimano/Sram, Art. 326293 = Sram XD, Art. 326298 = Campagnolo), mit Anti Bite Guard</li> </ul> <p><b>Felgen:</b></p> <ul style="list-style-type: none"> <li>• Aluminium-Hohlkammerfelge</li> <li>• Tubeless ready</li> <li>• 700C</li> <li>• für Drahtreifen</li> </ul> <p><b>Speichen:</b></p> <ul style="list-style-type: none"> <li>• Nirosta doppelkonifiziert</li> <li>• Aluminium Nippel</li> </ul> <p><b>Naben:</b></p> <ul style="list-style-type: none"> <li>• Bremsscheibenaufnahme vorne:</li> <li>• 4 in 1: vorbereitet für 12 mm Steckachse, optional umrüstbar durch Ausgleichshülsen für 5 mm (Art. 320117) oder 9 mm (Art. 320118) Schnellspanner und 15 mm (Art. 320120) Steckachse</li> <li>• Einbaumaß: 12 x 100 mm</li> <li>hinten:</li> <li>• 4 in 1: vorbereitet für 12 mm Steckachse, optional umrüstbar durch Umrüstsets für 5 mm Schnellspanner (Art. 320112), 10 mm (Art. 320079) und 12x135 mm Steckachse (Art. 320080)</li> <li>• Einbaumaß: 12 x 142 mm</li> </ul> <p><b>Felgen:</b></p> <ul style="list-style-type: none"> <li>• asymmetrisches Felgen-Design</li> <li>• Höhe 31,8 mm</li> <li>• vorne 24 Loch / hinten 28 Loch</li> </ul> <p><b>Extras:</b></p> <p>inkl. Ersatzspeichen, -nippel und Tubelessventil</p> <p>max. Fahrergewicht <b>110 kg</b></p>	<p><b>WHEEL SET 28" ›JETFLY‹</b></p> <p><b>Hubs:</b></p> <ul style="list-style-type: none"> <li>• aluminium side caps</li> <li>• 2/4 exchangeable, Japanese sealed bearings</li> <li>• for 8/9/10/11-speed Shimano or Sram cassette (MTB+Road)</li> <li>• red anodized, replaceable aluminium cassette body (art. 326297 = Shimano/Sram, art. 326293 = Sram XD, art. 326298 = Campagnolo), with Anti Bite Guard</li> </ul> <p><b>Rims:</b></p> <ul style="list-style-type: none"> <li>• aluminium double wall</li> <li>• tubeless ready</li> <li>• 700C</li> <li>• for clinchers</li> </ul> <p><b>Spokes:</b></p> <ul style="list-style-type: none"> <li>• double butted stainless steel</li> <li>• aluminium nipples</li> </ul> <p>›JETFLY DISC U4.0‹</p> <p><b>Hubs:</b></p> <ul style="list-style-type: none"> <li>• disc brake mount front:</li> <li>• 4 in 1: prepared for 12 mm thru axle, optionally convertible through spacers to 5 mm (art. 320117) or 9 mm (art. 320118) QR and 15 mm thru axle (art. 320120)</li> <li>• OLD: 12 x 100 mm</li> <li>rear:</li> <li>• 4 in 1: prepared for 12 mm thru axle, optionally convertible through spacers to 5 mm QR (art. 320112), 10 mm (art. 320079) and 12x135 mm thru axle (art. 320080)</li> <li>• OLD: 12 x 142 mm</li> </ul> <p><b>Rims:</b></p> <ul style="list-style-type: none"> <li>• asymmetric rim design</li> <li>• height 31.8 mm</li> <li>• front 24 hole / rear 28 hole</li> </ul> <p><b>Extras:</b></p> <p>incl. replacement spokes, nipples and tubeless valve</p> <p>max. riders weight <b>110 kg</b></p> <p style="text-align: right;">UVP 731,00 €</p> <table border="1" style="width: 100%; text-align: center;"> <tr> <td style="width: 25%;">Gravel/CX</td> <td style="width: 25%;">Sprint</td> <td style="width: 25%;">Endurance</td> <td style="width: 25%;">Aero / Time Trial</td> </tr> </table>	Gravel/CX	Sprint	Endurance	Aero / Time Trial	<p>Tested by the manufacturer based on ISO 4210</p> <p><b>TUBELESS READY</b></p> <p> 1.745 g</p>  <p>800 g</p>  <p>945 g</p>  <p>24.4 20.5 31.8</p> <p> 1.343 g</p>  <p>583 g</p>
Gravel/CX	Sprint	Endurance	Aero / Time Trial				
<p><b>384182</b> ›JETFLY SL‹ 1 set</p>	<p><b>Naben:</b></p> <ul style="list-style-type: none"> <li>• inkl. Schnellspanner</li> <li>• Einbaumaß vorne: 5 x 100 mm</li> <li>• Einbaumaß hinten: 5 x 130 mm</li> </ul> <p><b>Felgen:</b></p> <ul style="list-style-type: none"> <li>• vorne 20 Loch / hinten 24 Loch</li> <li>• mit aufgerauten Bremsflanken</li> </ul> <p><b>Speichen:</b></p> <ul style="list-style-type: none"> <li>• hinten asymmetrisch 8/16 Loch eingespeicht</li> </ul> <p><b>Extras:</b></p> <ul style="list-style-type: none"> <li>• inkl. Ersatzspeichen und -nippel</li> </ul> <p>max. Fahrergewicht <b>90 kg</b></p>	<p>›JETFLY SL‹</p> <p><b>Hubs:</b></p> <ul style="list-style-type: none"> <li>• incl. QRs</li> <li>• OLD front: 5 x 100 mm</li> <li>• OLD rear: 5 x 130 mm</li> </ul> <p><b>Rims:</b></p> <ul style="list-style-type: none"> <li>• front 20 hole / rear 24 hole</li> <li>• grooved braking sides</li> </ul> <p><b>Spokes:</b></p> <ul style="list-style-type: none"> <li>• rear wheel with asymmetrical 8/16 hole spokes pattern</li> </ul> <p><b>Extras:</b></p> <ul style="list-style-type: none"> <li>• incl. replacement spokes and nipples</li> </ul> <p>max. riders weight <b>90 kg</b></p> <p style="text-align: right;">UVP 731,00 €</p> <table border="1" style="width: 100%; text-align: center;"> <tr> <td style="width: 25%;">Gravel/CX</td> <td style="width: 25%;">Sprint</td> <td style="width: 25%;">Endurance</td> <td style="width: 25%;">Aero / Time Trial</td> </tr> </table>	Gravel/CX	Sprint	Endurance	Aero / Time Trial	 <p>760 g</p>  <p>21.3 17 23.4</p>
Gravel/CX	Sprint	Endurance	Aero / Time Trial				

ART.-NR.	BESCHREIBUNG	DESCRIPTION		
384181 1	<b>LAUFRADSATZ 28"</b> <b>&gt;CXD U4.0&lt;</b>  <b>Naben:</b> <ul style="list-style-type: none"> <li>• Aluminium-Dichtungsscheiben</li> <li>• Bremsscheibenaufnahme vorne:</li> <li>• <b>4 in 1:</b> vorbereitet für <b>12 mm Steckachse</b>, optional umrüstbar durch Ausgleichshülsen für 5 mm (Art. 320117) oder 9 mm (Art. 320118) Schnellspanner und 15 mm (Art. 320120) Steckachse</li> <li>• <b>2 austauschbare, japanische Industriekugellager</b></li> <li>• Einbaumaß: 12 x 100 mm</li> </ul> <b>hinten:</b> <ul style="list-style-type: none"> <li>• <b>4 in 1:</b> vorbereitet für <b>12 mm Steckachse</b>, optional umrüstbar durch Umrüstsets für 5 mm Schnellspanner (Art. 320112), 10 mm (Art. 320079) und 12x135 mm Steckachse (Art. 320080)</li> <li>• <b>4 austauschbare, japanische Industriekugellager</b></li> <li>• Einbaumaß: 12 x 142 mm</li> <li>• für <b>8/9/10/11-fach</b> Shimano oder Sram Kasette (MTB+Road)</li> <li>• <b>rot eloxierter, austauschbarer</b> Aluminium Kassettenkörper (Art. 326297 = Shimano/Sram, Art. 326293 = Sram XD, Art. 326298 = Campagnolo), mit <b>Anti Bite Guard</b></li> </ul> <b>Felgen:</b> <ul style="list-style-type: none"> <li>• <b>asymmetrisches Felgen-Design</b></li> <li>• Aluminium-Hohlkammerfelge</li> <li>• <b>Tubeless ready</b></li> <li>• 700C</li> <li>• Höhe 24 mm</li> <li>• vorne 20 Loch / hinten 24 Loch</li> <li>• für Drahtreifen</li> </ul> <b>Speichen:</b> <ul style="list-style-type: none"> <li>• <b>Nirosta doppelkonifiziert</b></li> <li>• mit <b>schwarzen Aluminium</b> Nippeln</li> </ul> <b>Extras:</b> inkl. Ersatzspeichen, -nippel und Tubelessventil  max. Fahrergewicht <b>110 kg</b>	<b>WHEEL SET 28"</b> <b>&gt;CXD U4.0&lt;</b>  <b>Hubs:</b> <ul style="list-style-type: none"> <li>• <b>aluminium</b> side caps</li> <li>• <b>disc brake mount front:</b></li> <li>• <b>4 in 1:</b> prepared for <b>12 mm thru axle</b>, optionally convertible through spacers to 5 mm (art. 320117) or 9 mm (art. 320118) QR and 15 mm thru axle (art. 320120)</li> <li>• <b>2 exchangeable, Japanese sealed bearings</b></li> <li>• OLD: 12 x 100 mm</li> </ul> <b>rear:</b> <ul style="list-style-type: none"> <li>• <b>4 in 1:</b> prepared for <b>12 mm thru axle</b>, optionally convertible through spacers to 5 mm QR (art. 320112), 10 mm (art. 320079) and 12x135 mm thru axle (art. 320080)</li> <li>• <b>4 exchangeable, Japanese sealed bearings</b></li> <li>• OLD: 12 x 142 mm</li> <li>• for <b>8/9/10/11-speed</b> Shimano or Sram cassette (MTB+Road)</li> <li>• <b>red anodized, replaceable</b> aluminium cassette body (art. 326297 = Shimano/Sram, art. 326293 = Sram XD, art. 326298 = Campagnolo), with <b>Anti Bite Guard</b></li> </ul> <b>Rims:</b> <ul style="list-style-type: none"> <li>• <b>asymmetric rim design</b></li> <li>• aluminium double wall</li> <li>• <b>tubeless ready</b></li> <li>• 700C</li> <li>• height 24 mm</li> <li>• front 20 hole / rear 24 hole</li> <li>• for clinchers</li> </ul> <b>Spokes:</b> <ul style="list-style-type: none"> <li>• <b>double butted stainless steel</b></li> <li>• with <b>black aluminium</b> nipples</li> </ul> <b>Extras:</b> incl. replacement spokes, nipples and tubeless valve  max. riders weight <b>110 kg</b>	Tested by the manufacturer based on ISO 4210 <b>TUBELESS READY</b> <b>CYCLO CROSS</b>   <b>DISC</b>     734 g   881 g  	
	Gravel/CX	Sprint	Endurance	Aero / Time Trial
	UVP 731,00 €			







ART.-NR.	BESCHREIBUNG	DESCRIPTION					
	<p><b>LAUFRADSATZ ›30◁</b></p> <p><b>Felgen:</b></p> <ul style="list-style-type: none"> <li>• Aluminium-Hohlkammerfelge</li> <li>• Tubeless ready</li> <li>• 700C</li> <li>• Höhe 30 mm</li> <li>• vorne 24 Loch / hinten 28 Loch</li> <li>• für Drahtreifen</li> </ul> <p><b>Speichen:</b></p> <ul style="list-style-type: none"> <li>• schwarz</li> <li>• mit Aluminium Nippeln</li> </ul> <p>max. Fahrergewicht <b>110 kg</b></p>	<p><b>WHEEL SET ›30◁</b></p> <p><b>Rims:</b></p> <ul style="list-style-type: none"> <li>• aluminium double wall</li> <li>• tubeless ready</li> <li>• 700C</li> <li>• height 30 mm</li> <li>• front 24 hole / rear 28 hole</li> <li>• for clinchers</li> </ul> <p><b>Spokes:</b></p> <ul style="list-style-type: none"> <li>• black</li> <li>• with aluminium nipples</li> </ul> <p>max. riders weight <b>110 kg</b></p>	<p>Tested by the manufacturer based on ISO 4210</p> <p><b>DISC</b></p>  <p>882 g</p>				
<b>384203</b>	<p><b>›30 DISC◁</b></p> <p>1 set</p> <p><b>Naben:</b></p> <ul style="list-style-type: none"> <li>• Centerlock-Bremsscheibenaufnahme vorne:</li> <li>• für 12 mm Steckachse</li> <li>• 2 austauschbare Industriekugellager</li> <li>• Einbaumaß: 12 x 100 mm</li> <li><b>hinten:</b></li> <li>• 5 austauschbare Industriekugellager</li> <li>• für 8/9/10/11-fach Shimano Kassette (MTB+Road)</li> <li>• Einbaumaß: 12 x 142 mm</li> </ul>	<p><b>›30 DISC ◁</b></p> <p><b>Hubs:</b></p> <ul style="list-style-type: none"> <li>• center lock - disc brake mount front:</li> <li>• for 12 mm thru axle</li> <li>• 2 exchangeable sealed bearings</li> <li>• OLD: 12 x 100 mm</li> <li><b>rear:</b></li> <li>• 5 exchangeable sealed bearings</li> <li>• for 8/9/10/11-speed Shimano cassette (MTB+Road)</li> <li>• OLD: 12 x 142 mm</li> </ul>	 <p>1.162 g</p>				
	<table border="1"> <tr> <td>Gravel/CX</td> <td>Sprint</td> <td>Endurance</td> <td>Aero / Time Trial</td> </tr> </table>	Gravel/CX	Sprint	Endurance	Aero / Time Trial		<p>UVP 475,00 €</p> <p><b>GREAT VALUE</b></p>  <p>1.900 g</p>
Gravel/CX	Sprint	Endurance	Aero / Time Trial				
<b>384159</b>	<p><b>›30 U.1.1◁</b></p> <p>1 set</p> <p><b>Naben:</b></p> <ul style="list-style-type: none"> <li>• inkl. Schnellspanner</li> <li>• mit Industriekugellager</li> <li><b>vorne:</b></li> <li>• Novatec Nabe A 141 SB</li> <li>• 20 Loch</li> <li><b>hinten:</b></li> <li>• Novatec Nabe F 422 SB</li> <li>• für 8/9/10/11-fach für Shimano Kassette (MTB+Road)</li> <li>• 24 Loch</li> </ul>	<p><b>›30 U.1.1◁</b></p> <p><b>Hubs:</b></p> <ul style="list-style-type: none"> <li>• incl. QR</li> <li>• with sealed bearing</li> <li><b>front:</b></li> <li>• Novatec hub A 141 SB</li> <li>• 20 hole</li> <li><b>rear:</b></li> <li>• Novatec hub F 422 SB</li> <li>• for 8/9/10/11 speed for Shimano cassette (MTB + road)</li> <li>• 24 hole</li> </ul>	 <p>820 g</p>				
	<table border="1"> <tr> <td>Gravel/CX</td> <td>Sprint</td> <td>Endurance</td> <td>Aero / Time Trial</td> </tr> </table>	Gravel/CX	Sprint	Endurance	Aero / Time Trial		 <p>1.080 g</p>
Gravel/CX	Sprint	Endurance	Aero / Time Trial				

CONVERSION KITS	Front hubs	5 mm	9 mm	12 mm	15 mm	20 mm	Rear hubs	5 x 135 mm	10 x 135 mm	12 x 135 mm	12 x 142 mm
	Diablo	320094				320293	325897	Diablo	320095		
Diablo XL							Flowtrail	320095			320096
Flowtrail	320094				320293	325897	Alpine	320095			320096
Alpine	320094				320293	325897	Dragon	320095			320096
Dragon	320094				320293	325897	Demon				
Demon	320094				320293	325897	CXD 4.0	320112	320079	320080	320081
CXD 4.0	320117	320118	320119	320120			Jetfly Disc 4.0	320112	320079	320080	320081
Jetfly Disc 4.0	320117	320118	320119	320120			R3 Disc 3.0	320112	320079	320080	320081
R3 Disc 3.0	320290			320107							



ART.-NR.	BESCHREIBUNG	DESCRIPTION	
384142 1 set	<b>LAUFRADSATZ ›FLOWTRAIL U2.1‹</b> <b>Naben:</b> <ul style="list-style-type: none"> <li>• Aluminium-Dichtungsscheiben</li> <li>• Bremsscheibenaufnahme vorne:</li> <li>• 2 austauschbare, japanische Industriekugellager</li> <li>• Einbaumaß: 15 x 100 mm</li> <li><b>hinten:</b></li> <li>• 4 austauschbare, japanische Industriekugellager</li> <li>• für 8/9/10/(11 MTB)-fach Shimano Kasette</li> <li>• schwarz eloxierter Kassettenkörper mit Anti Bite Guard (Art. 326296), umrüstbar auf Sram XD-Drive (Art. 326286)</li> <li>• Einbaumaß: 12 x 142 mm</li> <li><b>Felgen:</b></li> <li>• 29"</li> <li>• Parabolic-Rim-Design für optimale Kraftverteilung</li> <li>• Aluminium-Hohlkammerfelgen</li> <li>• Tubeless ready, mit Tubelessventil</li> <li>• 32 Loch</li> <li><b>Speichen:</b></li> <li>• Nirosta doppelkonifiziert</li> <li><b>Extras:</b></li> <li>• inkl. Ersatzspeichen, Ersatznippel, Felgenband</li> <li>max. Fahrergewicht <b>110 kg</b></li> </ul>	<b>WHEEL SET ›FLOWTRAIL U2.1‹</b> <b>Hubs:</b> <ul style="list-style-type: none"> <li>• aluminium side caps</li> <li>• disc brake mount</li> <li><b>front:</b></li> <li>• 2 exchangeable, Japanese sealed bearings</li> <li>• OLD: 15 x 100 mm</li> <li><b>rear:</b></li> <li>• 4 exchangeable, Japanese sealed bearings</li> <li>• for 8/9/10/(11 MTB) speed Shimano cassette</li> <li>• black anodized cassette body with Anti Bite Guard (art. 326296), convertible to Sram XD-Drive (art. 326286)</li> <li>• OLD: 12 x 142 mm</li> <li><b>Rims:</b></li> <li>• 29"</li> <li>• parabolic rim design for optimal force distribution</li> <li>• aluminium double wall</li> <li>• tubeless ready, with tubeless valve</li> <li>• 32 hole</li> <li><b>Spokes:</b></li> <li>• double butted stainless steel</li> <li><b>Extras:</b></li> <li>• incl. replacement spokes, nipples, rim tape</li> <li>max. riders weight <b>110 kg</b></li> </ul>	<p>Tested by the manufacturer based on ISO 4210</p> <p><b>BOOST</b></p> 
			UVP 699,00 €
	Crosscountry	Trail / Tour	All Mountain
		Enduro	Freeride
			Downhill

384162 1 set	<b>LAUFRADSATZ ›ALPINE U1‹</b> <b>Naben:</b> <ul style="list-style-type: none"> <li>• Aluminium-Dichtungsscheiben</li> <li>• Bremsscheibenaufnahme vorne:</li> <li>• 2 austauschbare, japanische Industriekugellager</li> <li>• Einbaumaß: 15 x 100 mm</li> <li><b>hinten:</b></li> <li>• 4 austauschbare, japanische Industriekugellager</li> <li>• für 8/9/10/(11 MTB)-fach Shimano-Kassette</li> <li>• schwarz eloxierter Kassettenkörper mit Anti Bite Guard (Art. 326296), umrüstbar auf Sram XD-Drive (Art. 326286)</li> <li>• Einbaumaß: 12 x 142 mm</li> <li><b>Felgen:</b></li> <li>• 29"</li> <li>• Parabolic-Rim-Design für optimale Kraftverteilung</li> <li>• Aluminium-Hohlkammerfelgen</li> <li>• Tubeless ready, mit Tubelessventil</li> <li>• 32 Loch</li> <li><b>Speichen:</b></li> <li>• Nirosta doppelkonifiziert</li> <li><b>Extras:</b></li> <li>• inkl. Ersatzspeichen, Ersatznippel, Felgenband</li> <li>max. Fahrergewicht <b>90 kg</b></li> </ul>	<b>WHEEL SET ›ALPINE U1‹</b> <b>Hubs:</b> <ul style="list-style-type: none"> <li>• aluminium side caps</li> <li>• disc brake mount</li> <li><b>front:</b></li> <li>• 2 exchangeable, Japanese sealed bearings</li> <li>• OLD: 15 x 100 mm</li> <li><b>rear:</b></li> <li>• 4 exchangeable, Japanese sealed bearings</li> <li>• for 8/9/10/(11 MTB) speed Shimano cassette</li> <li>• black anodized cassette body with Anti Bite Guard (art. 326296), convertible to Sram XD-Drive (art. 326286)</li> <li>• OLD: 12 x 142 mm</li> <li><b>Rims:</b></li> <li>• 29"</li> <li>• parabolic rim design for optimal force distribution</li> <li>• aluminium double wall</li> <li>• tubeless ready, with tubeless valve</li> <li>• 32 hole</li> <li><b>Spokes:</b></li> <li>• double butted stainless steel</li> <li><b>Extras:</b></li> <li>• incl. replacement spokes, nipples, rim tape</li> <li>max. riders weight <b>90 kg</b></li> </ul>	<p>Tested by the manufacturer based on ISO 4210</p> <p><b>BOOST</b></p> 
			UVP 669,00 €
	Crosscountry	Trail / Tour	All Mountain
		Enduro	Freeride
			Downhill

ART.-NR. 	BESCHREIBUNG	DESCRIPTION																			
<b>384166</b> 1 set	<b>LAUFRADSATZ ›DIABLO‹</b> <b>Naben:</b> <ul style="list-style-type: none"> <li>• <b>Bremsscheibenaufnahme</b></li> <li>• <b>Aluminium</b>-Dichtungsscheiben</li> </ul> <b>vorne:</b> <ul style="list-style-type: none"> <li>• <b>4 in 1 Nabe</b> serienmäßig mit 15 mm Steckachse (Umrüstset auf 5 mm bzw. 9 mm QR oder 20 mm Steckachse optional erhältlich)</li> <li>• <b>2 austauschbare, japanische Industriekugellager</b></li> </ul> <b>hinten:</b> <ul style="list-style-type: none"> <li>• <b>4 in1 Nabe</b> serienmäßig mit X12 Steckachse (Umrüstset auf 5 mm bzw. 10 mm QR oder 12 mm Festachse optional erhältlich)</li> <li>• <b>4 austauschbare, japanische Industriekugellager</b></li> <li>• für 8-11-fach Shimano Kassette (MTB)</li> <li>• <b>schwarz eloxierter</b> Kassettenkörper mit <b>Anti Bite Guard</b> (Art. 326296)</li> <li>• umrüstbar auf Sram XD Drive durch Kassettenkörper Art. 326286</li> <li>• Einbaumaß: 142 mm</li> </ul> <b>Felgen:</b> <ul style="list-style-type: none"> <li>• <b>Aluminium</b>-Hohlkammerfelge mit Ösen</li> <li>• <b>Tubeless ready</b></li> <li>• <b>650B/27,5"</b></li> <li>• 32 Loch</li> </ul> <b>Speichen:</b> <ul style="list-style-type: none"> <li>• <b>Nirosta doppelkonifiziert</b></li> </ul> max. Fahrergewicht 90 kg	<b>WHEEL SET ›DIABLO‹</b> <b>Hubs:</b> <ul style="list-style-type: none"> <li>• <b>disc brake mount</b></li> <li>• <b>aluminium</b> side caps</li> </ul> <b>front:</b> <ul style="list-style-type: none"> <li>• <b>4 in 1 hub</b> standard with 15 mm thru axle (conversion kit for 5 mm or 9 mm QR or 20 mm thru axle optionally available)</li> </ul> <b>2 exchangeable, Japanese sealed bearings</b> <b>rear:</b> <ul style="list-style-type: none"> <li>• <b>4 in1 hub</b> standard with X12 thru axle (conversion kit for 5 mm or 10 mm QR or 12 mm solid axle optionally available)</li> </ul> <b>4 exchangeable, Japanese sealed bearings</b> <ul style="list-style-type: none"> <li>• for 8-11 speed Shimano cassette (MTB)</li> <li>• <b>black anodized</b> cassette body with <b>Anti Bite Guard</b> (art. 326296)</li> <li>• convertible to Sram XD Drive by cassette body art. 326286</li> <li>• OLD: 142 mm</li> </ul> <b>Rims:</b> <ul style="list-style-type: none"> <li>• <b>aluminium</b> double wall rim with eyelets</li> <li>• <b>tubeless ready</b></li> <li>• <b>650B/27,5"</b></li> <li>• 32 hole</li> </ul> <b>Spokes:</b> <ul style="list-style-type: none"> <li>• <b>double butted stainless steel</b></li> </ul> max. riders weight 90 kg  UVP 659,00 €	<div style="display: flex; justify-content: space-between;"> <span>Tested by the manufacturer based on ISO 4210</span> <span><b>650 B</b></span> 1.860g</div> <div style="margin-top: 10px;"> <span style="border: 1px solid black; padding: 2px; font-weight: bold;">4 in 1</span> <p style="text-align: center;">830 g</p> <p style="text-align: center;">1.030 g</p> </div>																		
<b>384144</b> 1 set	<b>LAUFRADSATZ ›DEMON‹</b> <b>Naben</b> <ul style="list-style-type: none"> <li>• <b>Bremsscheibenaufnahme</b></li> <li>• <b>Aluminium</b>-Dichtungsscheiben</li> </ul> <b>vorne:</b> <ul style="list-style-type: none"> <li>• <b>4 in1 Scheibenbremsnabe</b> serienmäßig für 20 mm Steckachse. Umrüstkit für 5 mm, 10 mm, 15 mm (Art. 320293) optional auf Anfrage</li> <li>• 2 austauschbare, japanische Industriekugellager</li> <li>• Einbaumaß: 110 mm</li> </ul> <b>hinten:</b> <ul style="list-style-type: none"> <li>• <b>Scheibenbremsnabe</b> serienmäßig für 12 mm Steckachse (optional erweiterbar auf X12)</li> <li>• 4 austauschbare, japanische Industriekugellager</li> <li>• für 8-11-fach Shimano Kassette (MTB)</li> <li>• <b>schwarz eloxierter</b> Kassettenkörper mit <b>Anti Bite Guard</b> (Art. 326296)</li> <li>• umrüstbar auf Sram XD Drive durch Kassettenkörper Art. 326286</li> <li>• Einbaumaß: 157 mm</li> </ul> <b>Felgen:</b> <ul style="list-style-type: none"> <li>• Parabolic-Rim-Design für optimale Kraftverteilung</li> <li>• <b>breite Plus-Felge mit 26/32 mm</b></li> <li>• <b>Tubeless ready</b></li> <li>• <b>650B+/27,5+</b></li> <li>• Aluminium-Hohlkammerfelge mit Ösen</li> <li>• Verbindungsstelle verschweißst</li> <li>• 32 Loch</li> </ul> <b>Speichen:</b> <ul style="list-style-type: none"> <li>• <b>Nirosta doppelkonifiziert</b></li> </ul> <b>Extras:</b> <ul style="list-style-type: none"> <li>• inkl. Ersatzspeichen</li> <li>• inkl. Ersatznippel</li> </ul> max. Fahrergewicht <b>90 kg</b>	<b>WHEEL SET ›DEMON‹</b> <b>Hubs:</b> <ul style="list-style-type: none"> <li>• <b>disc brake mount</b></li> <li>• <b>aluminium</b> side caps</li> </ul> <b>front:</b> <ul style="list-style-type: none"> <li>• <b>4 in1 disc brake hub</b> standard for 20 mm thru axle. Conversion kit for 5 mm, 10 mm, 15 mm (art. 320293) optionally on request</li> </ul> <b>2 exchangeable, Japanese sealed bearings</b> <b>rear:</b> <ul style="list-style-type: none"> <li>• <b>disc brake hub</b> standard for 12 mm thru axle (optionally expandable to X12)</li> </ul> <b>4 exchangeable, Japanese sealed bearings</b> <ul style="list-style-type: none"> <li>• for 8-11 speed Shimano cassette (MTB)</li> <li>• <b>black anodized</b> cassette body with <b>Anti Bite Guard</b> (art. 326296)</li> <li>• convertible to Sram XD Drive by cassette body art. 326286</li> <li>• OLD: 157 mm</li> </ul> <b>Rims:</b> <ul style="list-style-type: none"> <li>• parabolic rim design for optimal force distribution</li> <li>• <b>wide Plus rim with 26/32 mm</b></li> <li>• <b>tubeless ready</b></li> <li>• <b>650B+/27,5+</b></li> <li>• aluminium double wall rim with eyelets</li> <li>• welded rim joint</li> <li>• 32 hole</li> </ul> <b>Spokes:</b> <ul style="list-style-type: none"> <li>• <b>double butted stainless steel</b></li> </ul> <b>Extras:</b> <ul style="list-style-type: none"> <li>• incl. replacement spokes</li> <li>• incl. replacement nipples</li> </ul> max. riders weight <b>90 kg</b>  UVP 731,00 €	<div style="display: flex; justify-content: space-between;"> <span>Tested by the manufacturer based on ISO 4210</span> <span><b>650 B+</b></span> 2.030g</div> <div style="margin-top: 10px;"> <span style="border: 1px solid black; padding: 2px; font-weight: bold; color: white; background-color: blue;">BACK FLIP WORLD RECORD</span> <p style="text-align: center;">905 g</p> <p style="text-align: center;">1.125 g</p> </div>																		
<table border="1" style="width: 100%; text-align: center; font-size: 8px;"> <tr> <td>Crosscountry</td> <td>Trail / Tour</td> <td>All Mountain</td> <td>Enduro</td> <td>Freeride</td> <td>Downhill</td> </tr> </table>	Crosscountry	Trail / Tour	All Mountain	Enduro	Freeride	Downhill	<table border="1" style="width: 100%; text-align: center; font-size: 8px;"> <tr> <td>Crosscountry</td> <td>Trail / Tour</td> <td>All Mountain</td> <td>Enduro</td> <td>Freeride</td> <td>Downhill</td> </tr> </table>	Crosscountry	Trail / Tour	All Mountain	Enduro	Freeride	Downhill	<table border="1" style="width: 100%; text-align: center; font-size: 8px;"> <tr> <td>Crosscountry</td> <td>Trail / Tour</td> <td>All Mountain</td> <td>Enduro</td> <td>Freeride</td> <td>Downhill</td> </tr> </table>	Crosscountry	Trail / Tour	All Mountain	Enduro	Freeride	Downhill	
Crosscountry	Trail / Tour	All Mountain	Enduro	Freeride	Downhill																
Crosscountry	Trail / Tour	All Mountain	Enduro	Freeride	Downhill																
Crosscountry	Trail / Tour	All Mountain	Enduro	Freeride	Downhill																

## LAUFRÄDER MADE BY MESSINGSCHLAGER

- "Made in Germany"
- attraktiver Preis
- Wunschkonfigurationen und Standardsortiment (permanent am Lager)
- 3 x zentriert (Höhenschlag: max. 0,4 mm, Seitenschlag: max. 0,5 mm) und 2 x abgedrückt
- **Boost, Superboost und Downhill!**

Wir beraten Sie gerne auch zu Laufrädern für E-Bikes!



## WHEEL SETS MADE BY MESSINGSCHLAGER

- "Made in Germany"
- attractive price
- custom-built configurations and standard wheel sets (permanently on stock)
- 3 x centering (height tolerance max. 0.4 mm, lateral tolerance max. 0.5 mm) and 2 x flexing
- **Boost, Superboost und Downhill!**

We are happy to advise you on wheels for e-bikes, too!



16" - 29" Aluminium- und Stahlfelgen (bis max. 30 mm Felgenbreite und -höhe) Felgenbandmontage auf Anfrage



16" - 29" aluminium and steel rims (max. 30 mm rim width and height) mounting of rim tape on request

**Nabenmodifikation** auf Anfrage (z. B. Kassettenkörperwechsel, Umbau der 4 in 1-Naben auf gewünschte Spezifikationen, ...), bis max. 160 mm Achslänge



**hub modifications** on request (e. g. cassette body alterations, modification of 4 in 1 hubs to other specifications, ...), max. 160 mm axle length

alle 2 mm Speichen (ausgenommen Aero-, Carbonspeichen und ungekröpfte Speichen) und 14G Nippel



all 2 mm spokes (except Aero, Carbon spokes and spokes with straight pull) and 14G nipples



### LAUFRÄDER 29" ›4.35 E-MTB‹

- Felgen: 35 mm, schwarz, geöst
- Speichen: **CnSpoke**
- Scheibenbremse: Centerlock
- inkl. Felgenband

NEW

**388709 Vorderrad**  
Nabe: **Novatec 15 x 110 mm Boost Standard** (Art. 326168)

#### Hinterrad

**388710 ›Microspline‹**  
Nabe: **Novatec 12 x 148 mm Boost Standard** (Art. 326161)

**388711 ›XD-Drive‹**  
Nabe: **Novatec 12 x 148 mm Boost Standard** (Art. 326162)

**388712 ›Shimano standard‹**  
Nabe: **Novatec 12 x 148 mm Boost Standard** (Art. 326160), für 8-11-fach Shimano Kasette (MTB)

### WHEEL SET 29" ›4.35 E-MTB‹

- rims: 35 mm, black, with eyelets
- spokes: **CnSpoke**
- disc brake: Centerlock
- incl. rim tape

**front wheel**  
hub: **Novatec 15 x 110 mm boost standard** (art. 326168)

UVP 119,95 €

#### rear wheel

**›Microspline‹**  
hub: **Novatec 12 x 148 mm boost standard** (art. 326161)

UVP 189,95 €

**›XD-Drive‹**  
hub: **Novatec 12 x 148 mm boost standard** (art. 326162)

UVP 189,95 €

**›Shimano standard‹**  
hub: **Novatec 12 x 148 mm boost standard** (art. 326160), für 8-11 speed Shimano cassette (MTB)

UVP 179,95 €

**BOOST**

**DISC**

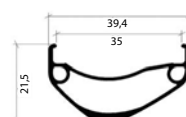







ART.-NR.	BESCHREIBUNG	DESCRIPTION	
<p><b>TRAIL / ENDURO</b> <b>4</b> 140 kg</p> <p><b>NEW</b></p>	<p><b>LAUFRÄDER 27,5" ›4.35 E-MTB‹</b></p> <ul style="list-style-type: none"> <li>Felgen: 35 mm, schwarz, geöst</li> <li>Speichen: <b>CnSpoke</b></li> <li>Scheibenbremse: Centerlock</li> <li>inkl. Felgenband</li> </ul> <p><b>388454 Vorderrad</b> Nabe: <b>Novatec 15 x 110 mm Boost Standard</b> (Art. 326168)</p> <p><b>Hinterrad</b></p> <p><b>388451 ›Microspline‹</b> Nabe: <b>Novatec 12 x 148 mm Boost Standard</b> (Art. 326161)</p> <p><b>388452 ›XD-Drive‹</b> Nabe: <b>Novatec 12 x 148 mm Boost Standard</b> (Art. 326162)</p> <p><b>388453 ›Shimano standard‹</b> Nabe: <b>Novatec 12 x 148 mm Boost Standard</b> (Art. 326160), für 8-11-fach Shimano Kassette (MTB)</p>	<p><b>WHEEL SET 27.5" ›4.35 E-MTB‹</b></p> <ul style="list-style-type: none"> <li>rims: 35 mm, black, with eyelets</li> <li>spokes: <b>CnSpoke</b></li> <li>disc brake: Centerlock</li> <li>incl. rim tape</li> </ul> <p><b>front wheel</b> hub: <b>Novatec 15 x 110 mm boost standard</b> (art. 326168) UVP 119,95 €</p> <p><b>rear wheel</b></p> <p><b>›Microspline‹</b> hub: <b>Novatec 12 x 148 mm boost standard</b> (art. 326161) UVP 189,95 €</p> <p><b>›XD-Drive‹</b> hub: <b>Novatec 12 x 148 mm boost standard</b> (art. 326162) UVP 189,95 €</p> <p><b>›Shimano standard‹</b> hub: <b>Novatec 12 x 148 mm boost standard</b> (art. 326160), for 8-11 speed Shimano cassette (MTB) UVP 179,95 €</p>	<p><b>BOOST</b> <b>DISC</b></p>
<p><b>TRAIL / ENDURO</b> <b>4</b> 140 kg</p>	<p><b>LAUFRÄDER 29" ›4.30 E-MTB‹</b></p> <ul style="list-style-type: none"> <li>Felgen: M-Wave, Enduro, (Art. 380467), 32 Loch, schwarz, für <b>Scheibenbremsen, Tubeless ready</b></li> <li>Speichen: <b>CnSpoke</b>, Nirosta, silber</li> <li>Nippel: <b>CnSpoke</b>, Messing, silber</li> <li>inkl. Felgenband (Art. 519206)</li> </ul> <p><b>388700 Vorderrad</b> Nabe: <b>Novatec 15 x 110 mm Boost Standard</b> (Art. 326137)</p> <p><b>388701 Hinterrad</b> Nabe: <b>Novatec 12 x 148 mm Boost Standard</b> (Art. 326184), für 8-11-fach Shimano Kassette (MTB)</p>	<p><b>WHEEL SET 29" ›4.30 E-MTB‹</b></p> <ul style="list-style-type: none"> <li>rims: M-Wave, Enduro, (art. 380467), 32 hole, black, for <b>disc brakes, tubeless ready</b></li> <li>spokes: <b>CnSpoke</b>, stainless, silver</li> <li>nipples: <b>CnSpoke</b>, brass, silver</li> <li>incl. rim tape (art. 519206)</li> </ul> <p><b>front wheel</b> hub: <b>Novatec 15 x 110 mm boost standard</b> (art. 326137) UVP 127,00 €</p> <p><b>rear wheel</b> hub: <b>Novatec 12 x 148 mm boost standard</b> (art. 326184), for 8-11 speed Shimano cassette (MTB) UVP 173,00 €</p>	<p><b>BOOST</b> <b>DISC</b></p>
<p><b>TREKING / GRAVEL</b> <b>2</b> 140 kg</p>	<p><b>LAUFRÄDER 28" ›2.19 TREKING‹</b></p> <ul style="list-style-type: none"> <li>Felgen: M-Wave, (Art. 380466), 32 Loch, schwarz, für <b>Scheibenbremsen</b></li> <li>Speichen: <b>CnSpoke</b>, Nirosta, silber</li> <li>Nippel: <b>CnSpoke</b>, Messing, silber</li> <li>inkl. Felgenband (Art. 519342)</li> </ul> <p><b>388621 Vorderrad</b> Nabe: <b>Novatec 5 x 100 mm</b> (Art. 326222)</p> <p><b>388622 Hinterrad</b> Nabe: <b>Novatec 5 x 135 mm</b> (Art. 326223), für 8-11-fach Shimano Kassette (MTB)</p>	<p><b>WHEEL SET 28" ›2.19 TREKING‹</b></p> <ul style="list-style-type: none"> <li>rims: M-Wave, (art. 380466), 32 hole, black, for <b>disc brakes</b></li> <li>spokes: <b>CnSpoke</b>, stainless, silver</li> <li>nipples: <b>CnSpoke</b>, brass, silver</li> <li>incl. rim tape (art. 519342)</li> </ul> <p><b>front wheel</b> hub: <b>Novatec 5 x 100 mm</b> (art. 326222) UVP 85,90 €</p> <p><b>rear wheel</b> hub: <b>Novatec 5 x 135 mm</b> (art. 326223), for 8-11 speed Shimano cassette (MTB) UVP 109,00 €</p>	<p><b>DISC</b></p>





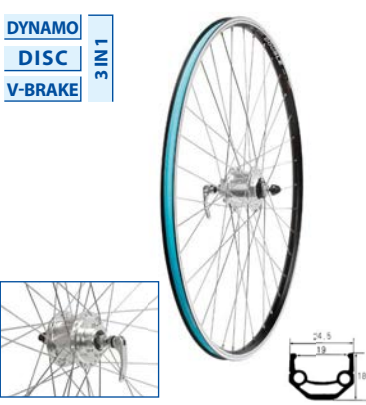

ART.-NR.	BESCHREIBUNG	DESCRIPTION	
<p><b>388304</b></p> <p><b>388305</b></p> <p>2</p>	<p><b>LAUFRÄDER ›DISC + V-BRAKE‹ 26"</b></p> <ul style="list-style-type: none"> <li>Felgen: <b>Remerx ›RMX Dragon L-719‹</b> (Art. 380272), 26", 32 Loch, schwarz, für <b>Scheiben- und V-Bremsen</b></li> <li>Speichen: <b>CnSpoke</b>, Nirosta, silber</li> <li>Nippel: <b>CnSpoke</b> (Art. 283295), silber</li> <li>inkl. Felgenband (Art. 519340)</li> </ul> <p><b>Vorderrad</b> Nabe: ›Sealed‹ <b>Scheibenbremsnaben</b> mit Schnellspanner (Art. 324920)</p> <p><b>Hinterrad</b> Nabe: ›Sealed‹ <b>Scheibenbremsnaben</b> mit Schnellspanner (Art. 324921) für 8-10-fach Shimano Kassette (MTB)</p>	<p><b>WHEEL SET ›DISC + V-BRAKE‹ 26"</b></p> <ul style="list-style-type: none"> <li>rims: <b>Remerx ›RMX Dragon L-719‹</b> (art. 380272), 26", 32 hole, black, for <b>disc and V-brakes</b></li> <li>spokes: <b>CnSpoke</b>, stainless, silver</li> <li>nipples: <b>CnSpoke</b> (art. 283295), silver</li> <li>incl. rim tape (art. 519340)</li> </ul> <p><b>front wheel</b> hub: ›Sealed‹ <b>disc brake hubs</b> with quick release (art. 324920)</p> <p><b>rear wheel</b> hub: ›Sealed‹ <b>disc brake hubs</b> with quick release (art. 324921) for 8-10 speed Shimano cassette (MTB)</p> <p>UVP 58,90 €</p> <p>UVP 69,90 €</p>	<p><b>DISC</b></p> <p><b>V-BRAKE</b></p> 
<p><b>388540</b></p> <p>2</p> <p><b>NICE PRICE</b></p>	<p><b>LAUFRAD</b></p> <p>›3 in 1: <b>DYNAMO + DISC + V‹ 28"</b></p> <ul style="list-style-type: none"> <li>Vorderrad-<b>Nabendynamo</b> (Art. 460058), mit dt. Prüfzeichen, für <b>Scheibenbremsen</b>, mit Schnellspanner</li> <li>Felgen: ›<b>Ventura Double</b>‹ (Art. 381025 28"), 36 Loch, schwarz, für <b>Scheiben- und V-Bremsen</b></li> <li>Speichen: <b>CnSpoke</b>, Nirosta, silber</li> <li>Nippel: <b>CnSpoke</b> (Art. 283295), silber</li> <li>inkl. Felgenband (Art. 519342)</li> </ul>	<p><b>WHEEL</b></p> <p>›3 in 1: <b>DYNAMO + DISC + V‹ 28"</b></p> <ul style="list-style-type: none"> <li>front <b>hub dynamo</b> (art. 460058), with German approval no., for <b>disc brakes</b>, with quick release</li> <li>rims: ›<b>Ventura Double</b>‹ (art. 381025 28"), 36 hole, black, for <b>disc and V-brakes</b></li> <li>spokes: <b>CnSpoke</b>, stainless, silver</li> <li>nipples: <b>CnSpoke</b> (art. 283295), silver</li> <li>incl. rim tape (art. 519342)</li> </ul> <p>UVP 89,90 €</p>	<p><b>DYNAMO</b></p> <p><b>DISC</b></p> <p><b>V-BRAKE</b></p> <p><b>3 IN 1</b></p> 
<p><b>388538</b></p> <p><b>388539</b></p> <p>2</p>	<p><b>LAUFRÄDER 28"</b></p> <ul style="list-style-type: none"> <li>Felgen: ›<b>Ventura Double</b>‹ (Art. 381025), 28", 36 Loch, schwarz</li> <li>Speichen: <b>CnSpoke</b>, Nirosta, silber</li> <li>Nippel: <b>CnSpoke</b> (Art. 283295), silber</li> <li>inkl. Felgenband (Art. 519342)</li> </ul> <p><b>Vorderrad</b> Nabe: ›<b>Sealed R</b>‹ mit Gummiabdichtung, mit Schnellspanner (Art. 325031)</p> <p><b>Hinterrad</b> Nabe: ›<b>Sealed R</b>‹ mit Gummiabdichtung, mit Schnellspanner (Art. 324854), für 8-9-fach Kassette</p>	<p><b>WHEEL SET 28"</b></p> <ul style="list-style-type: none"> <li>rims: ›<b>Ventura Double</b>‹ (art. 381025), 28", 36 hole, black</li> <li>spokes: <b>CnSpoke</b>, stainless, silver</li> <li>nipples: <b>CnSpoke</b> (art. 283295), silver</li> <li>incl. rim tape (art. 519342)</li> </ul> <p><b>front wheel</b> hub: ›<b>Sealed R</b>‹ with rubber seal, with QR (art. 325031)</p> <p><b>rear wheel</b> hub: ›<b>Sealed R</b>‹ with rubber seal, with QR (art. 324854), for 8-9 speed cassette</p> <p>UVP 59,90 €</p> <p>UVP 69,90 €</p>	
<p><b>INFO</b></p>	<p><b>Verpackung</b></p> <ul style="list-style-type: none"> <li>paarweise (VE = 2 Einzelräder, Karton Art. 084568 + Einlage Art. 084569 + 4x Nabenschutz Art. 384270)</li> <li>Montageverp. (VE = 12 Einzelräder, Karton Art. 084577 + 6x Einlagen Art. 084569 + 24x Nabenschutz Art. 384270)</li> </ul>	<p><b>Packaging</b></p> <ul style="list-style-type: none"> <li>in pairs (VE = 2 single wheels, carton art. 084568 + inlay art. 084569 + 4x hub protection art. 384270)</li> <li>OEM (VE = 12 single wheels, carton art. 084577 + 6x inlays art. 084569 + 24x hub protection art. 384270)</li> </ul>	



# HEAD SETS

SHIS =  
Standard  
Head set  
Identification  
System

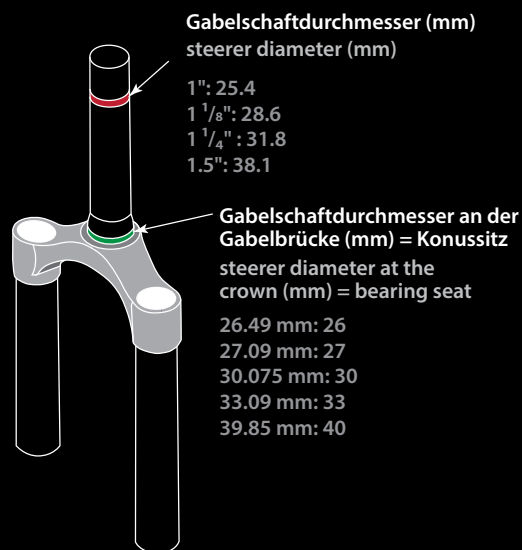
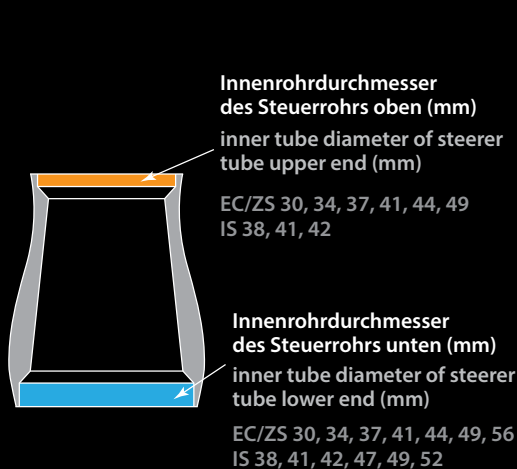

Durchmesser sind in Millimeter angegeben. Die Werte wurden für die Bezeichnung teilweise gerundet (Beispiel: Der Steuerrohrinnendurchmesser von IS42 liegt bei 41,95 mm).

Diameters are indicated in millimeter. The values have been rounded for the designation (example: The head tube inner diameter of IS42 is 41.95 mm).







ART.-NR.	BESCHREIBUNG	DESCRIPTION	
<p>• <b>390801</b> 100 set</p>	<p><b>INTEGRIERTER CARTRIDGE STEUERSATZ, 1 1/8" → 1,5"</b> &gt;IS42/52 C&lt;</p> <ul style="list-style-type: none"> <li>• <b>Aluminium</b></li> <li>• 45° x 45°</li> <li>• mit <b>Industriekugellager</b></li> <li>• inkl. Krallen</li> <li>• schwarz</li> <li>• <b>nur 80 g</b> (ohne Krallen)</li> <li>• SHIS: IS42/28,6   IS52/40</li> <li>• im M-Wave Einzelkarton</li> </ul> <p><b>A</b> = 28,5 mm = Innen-Ø des oberen Abschlussrings <b>B1</b> = 41,8 mm = Außen-Ø des oberen Kugellagers <b>B2</b> = 52,0 mm = Außen-Ø des unteren Kugellagers <b>C</b> = 39,8 mm = Konussitz auf Gabel</p>	<p><b>INTEGRATED CARTRIDGE HEAD SET, 1 1/8" → 1.5"</b> &gt;IS42/52 C&lt;</p> <ul style="list-style-type: none"> <li>• <b>aluminium</b></li> <li>• 45° x 45°</li> <li>• with <b>sealed bearing</b></li> <li>• incl. star nut</li> <li>• black</li> <li>• <b>only 80 g</b> (w/o star nut)</li> <li>• SHIS: IS42/28.6   IS52/40</li> <li>• in M-Wave box</li> </ul> <p><b>A</b> = 28.5 mm = inner-Ø of the upper cap ring <b>B1</b> = 41.8 mm = outer-Ø of the upper bearing <b>B2</b> = 52.0 mm = outer-Ø of the lower bearing <b>C</b> = 39.8 mm = cone seat on the fork</p> <p style="text-align: right;">UVP 19,90 €</p>	
<p><b>390362</b> 100 set</p>	<p><b>INTEGRIERTER CARTRIDGE STEUERSATZ, 1 1/8" → 1 1/4"</b></p> <p>1 1/8" oben auf 1 1/4" unten</p> <ul style="list-style-type: none"> <li>• wiederverwendbare Klemme für <b>Carbon-Gabelschaft</b></li> <li>• <b>nur 77 g</b> (ohne Klemme)</li> <li>• SHIS: IS42/28,6   IS47/33</li> <li>• in Neco Eurolochbox</li> </ul> <p><b>A</b> = 28,5 mm <b>B1</b> = 41,8 mm <b>B2</b> = 47,0 mm <b>C</b> = 33,0 mm</p>	<p><b>INTEGRATED CARTRIDGE HEAD SET, 1 1/8" → 1 1/4"</b></p> <p>1 1/8" top to 1 1/4" bottom</p> <ul style="list-style-type: none"> <li>• reusable clamp for <b>carbon steerer</b></li> <li>• <b>only 77 g</b> (w/o clamp)</li> <li>• SHIS: IS42/28.6   IS47/33</li> <li>• in Neco eurohole box</li> </ul> <p><b>A</b> = 28.5 mm <b>B1</b> = 41.8 mm <b>B2</b> = 47.0 mm <b>C</b> = 33.0 mm</p> <p style="text-align: right;">UVP 29,90 €</p>	
<p><b>390364</b> 100 set</p>	<p><b>INTEGRIERTER CARTRIDGE STEUERSATZ 1 1/8"</b></p> <ul style="list-style-type: none"> <li>• <b>Aluminium</b></li> <li>• schwarz</li> <li>• Campa Standard = 41,8 mm x 45° x 45°</li> <li>• inkl. Krallen</li> <li>• <b>nur 62 g</b> (ohne Krallen)</li> <li>• SHIS: IS42/28,6   IS42/30</li> <li>• im Einzelkarton</li> </ul> <p><b>A</b> = 28,5 mm <b>B1=B2</b> = 41,8 mm <b>C</b> = 30,0 mm</p>	<p><b>INTEGRATED CARTRIDGE HEAD SET 1 1/8"</b></p> <ul style="list-style-type: none"> <li>• <b>aluminium</b></li> <li>• black</li> <li>• Campa standard = 41.8 mm x 45° x 45°</li> <li>• incl. star nut</li> <li>• <b>only 62 g</b> (w/o star nut)</li> <li>• SHIS: IS42/28.6   IS42/30</li> <li>• in box</li> </ul> <p><b>A</b> = 28.5 mm <b>B1=B2</b> = 41.8 mm <b>C</b> = 30.0 mm</p> <p style="text-align: right;">UVP 27,90 €</p>	

ART.-NR. 	BESCHREIBUNG	DESCRIPTION	
<b>390514</b> 100 set	<b>INTEGRIERTER CARTRIDGE STEUERSATZ 1 1/8"</b> <ul style="list-style-type: none"> <li>• <b>Aluminium</b></li> <li>• schwarz</li> <li>• Campa Standard = 41,8 mm x 45° x 45°</li> <li>• 2 x 0,28 mm Ausgleichsscheiben</li> <li>• inkl. wiederverwendbarer Klemme <b>für Carbon-Gabelschaft</b></li> <li>• <b>nur 73 g</b> (ohne Klemme)</li> <li>• SHIS: IS42/28,6   IS42/30</li> <li>• in Neco Eurolochbox</li> </ul> <p> <b>A</b> = 28,5 mm  <b>B1=B2</b> = 41,8 mm  <b>C</b> = 30,0 mm                 </p>	<b>INTEGRATED CARTRIDGE HEAD SET 1 1/8"</b> <ul style="list-style-type: none"> <li>• <b>aluminium</b></li> <li>• black</li> <li>• Campa standard = 41.8 mm x 45° x 45°</li> <li>• 2 x 0.28 mm shims</li> <li>• incl. reusable clamp <b>for carbon steerer</b></li> <li>• <b>only 73 g</b> (w/o clamp)</li> <li>• SHIS: IS42/28.6   IS42/30</li> <li>• in Neco eurohole box</li> </ul> <p> <b>A</b> = 28.5 mm  <b>B1=B2</b> = 41.8 mm  <b>C</b> = 30.0 mm                 </p>	
<b>390800</b> 100 set	<b>INTEGRIERTER CARTRIDGE STEUERSATZ 1 1/8"</b> ›IS42/42 C‹	<b>INTEGRATED CARTRIDGE HEAD SET 1 1/8"</b> ›IS42/42 C‹	

UVP 19,90 €

UVP 14,90 €

## AHEAD SEMI-INTEGRIERT AHEAD SEMI INTEGRATED

<b>390809</b> 100 set	<b>SEMI-INTEGRIERTER CARTRIDGE STEUERSATZ 1 1/8" → 1,5"</b> ›ZS44/56 C‹	<b>SEMI INTEGRATED CARTRIDGE HEAD SET 1 1/8" → 1.5"</b> ›ZS44/56 C‹	
--------------------------	--	--	--

- A** = 28,6 mm  
= Innen-Ø des oberen Abschlussrings
- B1** = 44 mm  
= Außen-Ø der oberen Lagerschale
- B2** = **56,0 mm**  
= Außen-Ø der unteren Lagerschale
- C** = 39,8 mm  
= Konussitz auf Gabel

- A** = 28.6 mm  
= inner-Ø of the upper cap ring
- B1** = 44 mm  
= outer-Ø of the upper bearing shell
- B2** = **56.0 mm**  
= outer-Ø of the lower bearing shell
- C** = 39.8 mm  
= cone seat on the fork

Tested by the manufacturer based on ISO 4210

UVP 19,90 €

ART.-NR.	BESCHREIBUNG	DESCRIPTION	
<b>390579</b> 100 set	<b>SEMI-INTEGRIERTER RETAINER TAPERED STEUERSATZ 1 1/8" → 1,5"</b> <ul style="list-style-type: none"> <li>• 1 1/8" oben / 1,5" unten</li> <li>• schwarz</li> <li>• <b>Aluminium</b>/Stahl</li> <li>• SHIS: ZS44/28,6   ZS56/40</li> <li>• in Neco Eurolochbox</li> </ul> <p><b>A</b> = 28,6 mm = Innen-Ø des oberen Abschlussrings</p> <p><b>B1</b> = 44 mm = Außen-Ø der oberen Kugellagerschale</p> <p><b>B2</b> = <b>56,0 mm</b> = Außen-Ø der unteren Kugellagerschale</p> <p><b>C</b> = 39,8 mm = Konussitz auf Gabel</p>	<b>SEMI INTEGRATED RETAINER TAPERED HEAD SET 1 1/8" → 1.5"</b> <ul style="list-style-type: none"> <li>• 1 1/8" top / 1.5" bottom</li> <li>• black</li> <li>• <b>aluminium</b>/steel</li> <li>• SHIS: ZS44/28.6   ZS56/40</li> <li>• in Neco eurohole box</li> </ul> <p><b>A</b> = 28.6 mm = inner-Ø of the upper cap ring</p> <p><b>B1</b> = 44 mm = outer-Ø of the upper bearing shell</p> <p><b>B2</b> = <b>56.0 mm</b> = outer-Ø of the lower bearing shell</p> <p><b>C</b> = 39.8 mm = cone seat on the fork</p> <p>UVP 14,90 €</p>	
<b>390606</b> 100 set	wie Art. 390579, aber <ul style="list-style-type: none"> <li>• SHIS: ZS44/28,6   ZS55/39,8</li> <li>• <b>B2 = 55,0 mm</b></li> </ul>	like art. 390579, but <ul style="list-style-type: none"> <li>• SHIS: ZS44/28.6   ZS55/39.8</li> <li>• <b>B2 = 55.0 mm</b></li> </ul> <p>UVP 14,90 €</p>	
<b>390810</b> 100 set	<b>SEMI-INTEGRIERTER TAPERED STEUERSATZ 1 1/8" → 1,5"</b> <b>&gt;ZS44/56 LB&lt;</b> <ul style="list-style-type: none"> <li>• 1 1/8" oben / 1,5" unten</li> <li>• schwarz</li> <li>• <b>Aluminium</b>/Stahl</li> <li>• SHIS: ZS44/28,6   ZS56/40</li> <li>• im M-Wave Einzelkarton</li> </ul> <p><b>A</b> = 28,6 mm = Innen-Ø des oberen Abschlussrings</p> <p><b>B1</b> = 44 mm = Außen-Ø der oberen Kugellagerschale</p> <p><b>B2</b> = <b>56,0 mm</b> = Außen-Ø der unteren Kugellagerschale</p> <p><b>C</b> = 39,8 mm = Konussitz auf Gabel</p>	<b>SEMI INTEGRATED TAPERED HEAD SET 1 1/8" → 1.5"</b> <b>&gt;ZS44/56 LB&lt;</b> <ul style="list-style-type: none"> <li>• 1 1/8" top / 1.5" bottom</li> <li>• black</li> <li>• <b>aluminium</b>/steel</li> <li>• SHIS: ZS44/28.6   ZS56/40</li> <li>• in M-Wave box</li> </ul> <p><b>A</b> = 28.6 mm = inner-Ø of the upper cap ring</p> <p><b>B1</b> = 44 mm = outer-Ø of the upper bearing shell</p> <p><b>B2</b> = <b>56.0 mm</b> = outer-Ø of the lower bearing shell</p> <p><b>C</b> = 39.8 mm = cone seat on the fork</p> <p>UVP 9,90 €</p>	
<b>390319</b> 100 set	<b>SEMI-INTEGRIERTER CARTRIDGE STEUERSATZ 1 1/8"</b> <ul style="list-style-type: none"> <li>• <b>Aluminium</b></li> <li>• schwarz</li> <li>• 1 1/8"</li> <li>• <b>nur 79 g</b> (ohne Krallen)</li> <li>• SHIS: ZS44/28,6   ZS44/30</li> <li>• im Einzelkarton</li> </ul> <p><b>A</b> = 28,6 mm <b>B</b> = 44,0 mm <b>C</b> = 30,0 mm</p>	<b>SEMI INTEGRATED CARTRIDGE HEAD SET 1 1/8"</b> <ul style="list-style-type: none"> <li>• <b>aluminium</b></li> <li>• black</li> <li>• 1 1/8"</li> <li>• <b>only 79 g</b> (w/o star nut)</li> <li>• SHIS: ZS44/28.6   ZS44/30</li> <li>• in box</li> </ul> <p><b>A</b> = 28.6 mm <b>B</b> = 44.0 mm <b>C</b> = 30.0 mm</p> <p>UVP 36,90 €</p>	
<b>390580</b> 100 set	<b>SEMI-INTEGRIERTER CARTRIDGE STEUERSATZ 1 1/8" &gt;ZS44/44 C&lt;</b> <ul style="list-style-type: none"> <li>• <b>Aluminium</b></li> <li>• schwarz</li> <li>• 1 1/8"</li> <li>• SHIS: ZS44/28,6   ZS44/30</li> <li>• im M-Wave Einzelkarton</li> </ul> <p><b>A</b> = 28,6 mm <b>B</b> = 44,0 mm <b>C</b> = 30,0 mm</p>	<b>SEMI INTEGRATED CARTRIDGE HEAD SET 1 1/8" &gt;ZS44/44 C&lt;</b> <ul style="list-style-type: none"> <li>• <b>aluminium</b></li> <li>• black</li> <li>• 1 1/8"</li> <li>• SHIS: ZS44/28.6   ZS44/30</li> <li>• in M-Wave box</li> </ul> <p><b>A</b> = 28.6 mm <b>B</b> = 44.0 mm <b>C</b> = 30.0 mm</p> <p>UVP 19,90 €</p>	

ART.-NR.	BESCHREIBUNG	DESCRIPTION	
	<b>SEMI-INTEGRIERTER RETAINER STEUERSATZ 1 1/8"</b> <ul style="list-style-type: none"> <li>• Aluminium/Stahl</li> <li>• schwarz</li> <li>• 1 1/8"</li> <li>• SHIS: ZS44/28,6   ZS44/30</li> </ul> <p>A = 28,6 mm B = 44,0 mm C = 30,0 mm</p>	<b>SEMI INTEGRATED RETAINER HEAD SET 1 1/8"</b> <ul style="list-style-type: none"> <li>• aluminium/steel</li> <li>• black</li> <li>• 1 1/8"</li> <li>• SHIS: ZS44/28.6   ZS44/30</li> </ul> <p>A = 28.6 mm B = 44.0 mm C = 30.0 mm</p>	
390320	in Neco Eurolochbox	in Neco eurohole box	
• 390808	Montageverpackung	OEM	
100 set			UVP 14,90 €

## AHEAD AUSSENLIEGENDE LAGERSCHALEN

## AHEAD EXTERNAL CUPS

390343	<b>CARTRIDGE STEUERSATZ</b> <ul style="list-style-type: none"> <li>• Aluminium</li> <li>• im Einzelkarton</li> <li>• 1"</li> <li>• silber</li> <li>• nur 72 g (ohne Krallen)</li> <li>• SHIS: EC30/25,4   EC30/26,4</li> </ul> <p>A = 25,4 mm B = 30,2 mm C = 26,4 mm</p>	<b>CARTRIDGE HEAD SET</b> <ul style="list-style-type: none"> <li>• aluminium</li> <li>• in box</li> <li>• 1"</li> <li>• silver</li> <li>• only 72 g (w/o star nut)</li> <li>• SHIS: EC30/25.4   EC30/26.4</li> </ul> <p>A = 25.4 mm B = 30.2 mm C = 26.4 mm</p>	
100 set			UVP 37,90 €
390344	<ul style="list-style-type: none"> <li>• 1 1/8"</li> <li>• nur 85 g (ohne Krallen)</li> <li>• SHIS: EC34/28,6   EC34/30</li> </ul> <p>A = 28,6 mm B = 34,0 mm C = 30,0 mm</p>	<ul style="list-style-type: none"> <li>• 1 1/8"</li> <li>• only 85 g (w/o star nut)</li> <li>• SHIS: EC34/28.6   EC34/30</li> </ul> <p>A = 28.6 mm B = 34.0 mm C = 30.0 mm</p>	
390347	schwarz	black	
390301	<b>RETAINER STEUERSATZ</b> <ul style="list-style-type: none"> <li>• Stahl</li> <li>• schwarz</li> <li>• in Neco Eurolochbox</li> <li>• 1"</li> <li>• SHIS: EC30/25,4   EC30/26,4</li> </ul> <p>A = 25,4 mm B = 30,2 mm C = 26,4 mm</p>	<b>RETAINER HEAD SET</b> <ul style="list-style-type: none"> <li>• steel</li> <li>• black</li> <li>• in Neco eurohole box</li> <li>• 1"</li> <li>• SHIS: EC30/25.4   EC30/26.4</li> </ul> <p>A = 25.4 mm B = 30.2 mm C = 26.4 mm</p>	
390310	<ul style="list-style-type: none"> <li>• 1 1/8"</li> <li>• SHIS: EC34/28,6   EC34/30</li> </ul> <p>A = 28,6 mm B = 34,0 mm C = 30,0 mm</p>	<ul style="list-style-type: none"> <li>• 1 1/8"</li> <li>• SHIS: EC34/28.6   EC34/30</li> </ul> <p>A = 28.6 mm B = 34.0 mm C = 30.0 mm</p>	
• 390393	wie Art. 390310, aber ohne Logo, in Montageverpackung	like art. 390310, but without logo, OEM	UVP 8,90 €
390316	wie Art. 390310, aber Aluminiumschalen/Stahl	like art. 390310, but aluminium shells/steel	UVP 14,90 €



ART.-NR.	BESCHREIBUNG	DESCRIPTION	
<b>390890</b> 100	<b>KLEMME FÜR AHEAD STEUERSATZ ›FORK FIX C‹</b> <ul style="list-style-type: none"> <li>wiederverwendbare Ahead-Klemme</li> <li>für Carbon-Gabelschaft</li> <li>1 1/8"</li> <li>auf M-Wave Eurolochkarte</li> </ul>	<b>COMPRESSOR PLUG FOR AHEAD HEAD SET ›FORK FIX C‹</b> <ul style="list-style-type: none"> <li>reusable ahead clamp</li> <li>for carbon steerer</li> <li>1 1/8"</li> <li>on M-Wave eurohole card</li> </ul>	 UVP 6,90 €
<b>390570</b> <b>390571</b> 100 set	<b>KRALLE + ALUMINIUMKAPPE + SCHRAUBE FÜR AHEAD STEUERSATZ ›FORK FIX‹</b> <ul style="list-style-type: none"> <li>Kralle, Alukappe und Schraube in einem</li> <li>für 1 1/8"</li> </ul> auf M-Wave Eurolochkarte	<b>STAR NUT + ALUMINIUM CAP + SCREW FOR AHEAD HEAD SET ›FORK FIX‹</b> <ul style="list-style-type: none"> <li>star nut, aluminium cap and screw</li> <li>for 1 1/8"</li> </ul> on M-Wave eurohole card	 UVP 4,90 €
<b>390561</b> <b>390461</b> <b>390555</b> 500/100 set	Montageverpackung	OEM	
<b>390517</b> 200/50	<b>STEUERSATZKAPPE ›CHEERS‹</b> <ul style="list-style-type: none"> <li>mit magnetischer Halterung für <b>Kronkorken</b></li> <li>für 1 1/8" Ahead Steuersätze</li> <li>Aluminium</li> <li>inkl. Befestigungsschraube</li> <li>auf M-Wave Eurolochkarte</li> </ul>	<b>HEAD SET CAP ›CHEERS‹</b> <ul style="list-style-type: none"> <li>with magnetic holder <b>for bottle caps</b></li> <li>for 1 1/8" ahead head sets</li> <li>aluminium</li> <li>incl. mounting screw</li> <li>on M-Wave eurohole card</li> </ul>	 UVP 9,90 €



# UPGRADE YOUR E-BIKE





SCHEINWERFER  
HEAD LAMP

***messingschlager***

E-Mobility Solutions

From full  
Suspension  
Mountainbike  
to SUV



Please contact us  
[e-mobility@messingschlager.com](mailto:e-mobility@messingschlager.com)

SCHUTZBLECH / MUDGUARD

STECKACHSE / THRU AXLE



ART.-NR.	BESCHREIBUNG	DESCRIPTION	
	<p><b>ERSATZKUGELLAGER</b></p> <p><b>390770</b> <b>Standard 1"</b>, 27,2 (A) x 38 (B) x 6,3 mm (C), 45°, passend z. B. für Art. 390343, 390353, ...</p> <p><b>390771</b> <b>Standard 1½"</b>, 30,2 (A) x 41 (B) x 6,3 mm (C), 45°, passend z. B. für Art. 390344, 390353, ...</p> <p><b>390772</b> <b>semi-integriert 1½"</b>, 30,2 (A) x 41,8 (B) x 6,3 mm (C), 45°/45°, passend z. B. für Art. 390319, 390363 (oben)/4, mit Spacer für Art. 390362/5, 390514, ...</p> <p><b>390775</b> <b>integriert 1½"</b>, 30,2 (A) x 41,8 (B) x 7 mm (C), 45°/45°, passend z. B. für Art. 390362/65 (oben), ...</p> <p><b>390773</b> <b>integriert 1¼"</b>, 35 (A) x 47 (B) x 8 mm (C), 45°/45°, passend z. B. für Art. 390362 (unten), ...</p> <p><b>390774</b> <b>integriert 1½"</b>, 40 (A) x 52 (B) x 8 mm (C), 45°/45°, passend z. B. für Art. 390363/65 (unten), ...</p>	<p><b>SPARE BALL BEARINGS</b></p> <p><b>standard 1"</b>, 27.2 (A) x 38 (B) x 6.3 mm (C), 45°, suitable e. g. for art. 390343, 390353, ...</p> <p>UVP 8,90 €</p> <p><b>standard 1½"</b>, 30.2 (A) x 41 (B) x 6.3 mm (C), 45°, suitable e. g. for art. 390344, 390353, ...</p> <p>UVP 8,90 €</p> <p><b>semi integrated 1½"</b>, 30.2 (A) x 41.8 (B) x 6.3 mm (C), 45°/45°, suitable e. g. for art. 390319, 390363 (top)/4, with spacers for art. 390362/5, 390514, ...</p> <p>UVP 8,90 €</p> <p><b>integrated 1½"</b>, 30.2 (A) x 41.8 (B) x 7 mm (C), 45°/45°, suitable e. g. for art. 390362/65 (top), ...</p> <p>UVP 8,90 €</p> <p><b>integrated 1¼"</b>, 35 (A) x 47 (B) x 8 mm (C), 45°/45°, suitable e. g. for art. 390362 (down), ...</p> <p>UVP 9,90 €</p> <p><b>integrated 1½"</b>, 40 (A) x 52 (B) x 8 mm (C), 45°/45°, suitable e. g. for art. 390363/65 (down), ...</p> <p>UVP 9,90 €</p>	 
	<p><b>DISTANZRINGE ›RIO SPACER‹</b></p> <ul style="list-style-type: none"> <li>• Aluminium</li> <li>• für 1½"</li> </ul> <p><b>5 mm, 6 Stück</b> auf M-Wave Eurolochkarte</p> <p><b>390640</b> schwarz eloxiert</p> <p><b>390641</b> silber eloxiert</p> <p>500 set</p> <p><b>5 mm, Montageverpackung</b></p> <ul style="list-style-type: none"> <li>• <b>390602</b> schwarz eloxiert</li> <li>• <b>390601</b> silber eloxiert</li> </ul> <p>2.000/200</p> <p>1.000/200</p> <ul style="list-style-type: none"> <li>• <b>390603</b> • <b>10 mm</b></li> <li>• schwarz</li> <li>• Montageverpackung</li> </ul> <p>1.000/100</p> <ul style="list-style-type: none"> <li>• <b>390604</b> • <b>20 mm</b></li> <li>• schwarz</li> <li>• Montageverpackung</li> </ul> <p>500/100</p>	<p><b>SPACERS ›RIO SPACER‹</b></p> <ul style="list-style-type: none"> <li>• aluminium</li> <li>• for 1½"</li> </ul> <p><b>5 mm, 6 pcs</b> on M-Wave eurohole card</p> <p>black anodised</p> <p>silver anodised</p> <p>UVP 5,90 €</p> <p><b>5 mm, OEM</b></p> <p>black anodised</p> <p>silver anodised</p> <p>UVP 0,90 €</p> <ul style="list-style-type: none"> <li>• <b>10 mm</b></li> <li>• black</li> <li>• OEM</li> </ul> <p>UVP 1,49 €</p> <ul style="list-style-type: none"> <li>• <b>20 mm</b></li> <li>• black</li> <li>• OEM</li> </ul> <p>UVP 1,90 €</p>	     



ART.-NR.	BESCHREIBUNG	DESCRIPTION	
<b>390627</b> 250/50 set	<b>AUSGLEICHSHÜLSE FÜR STEUERSATZ</b> <ul style="list-style-type: none"> <li>• <b>Aluminium</b></li> <li>• wird eingesetzt, um das <b>Steuersatzrohr</b> zu reduzieren, damit ein Steuersatz mit kleinerem Durchmesser benutzt werden kann</li> <li>• reduziert von <b>1½" auf 1"</b> (Außen-Ø 34,0 mm /Innen-Ø 30,2 mm)</li> <li>• 1 Set = 2 Stk.</li> </ul>	<b>ADAPTER FOR HEAD SET</b> <ul style="list-style-type: none"> <li>• <b>aluminium</b></li> <li>• to be inserted in order to reduce <b>head tube</b> for using head set with smaller diameter</li> <li>• to reduce <b>1½" to 1"</b> (outer-Ø 34.0 mm /inner-Ø 30.2 mm)</li> <li>• 1 set = 2 pcs.</li> </ul>	
<b>390366</b> 1.000/100	<b>GABELKONUSADAPTER</b> <ul style="list-style-type: none"> <li>• <b>geschlitzt</b>, für einfache <b>Montage</b></li> <li>• schwarz</li> <li>• <b>1,5" → 1½"</b></li> <li>• zur Verwendung von 1½" Gabeln in Rahmen mit 1,5" Steuersatzrohren</li> <li>• Innendurchmesser 30 mm (1½"), Außendurchmesser für 1,5" Steuersätze</li> <li>• passend für Art. 390322/365/579, ...</li> <li>• Montageverpackung</li> </ul>	<b>FORK/HEAD SET CONE ADAPTER</b> <ul style="list-style-type: none"> <li>• <b>slotted</b>, for easy <b>installation</b></li> <li>• black</li> <li>• <b>1.5" → 1½"</b></li> <li>• fits 1½" forks in frames with 1.5" steerer tubes</li> <li>• inner diameter 30 mm (1½"), outer diameter for 1.5" head sets</li> <li>• suitable for art. 390322/365/579, ...</li> <li>• OEM</li> </ul>	

UVP 4,90 €

UVP 3,50 €

Abb. ähnlich / similar picture

## GEWINDE-STEUERSÄTZE

## THREADED HEAD SETS

<b>CARTRIDGE STEUERSATZ TANGE SEIKI</b> <ul style="list-style-type: none"> <li>• <b>Aluminium</b></li> <li>• im Einzelkarton</li> <li>• <b>1"</b>, nur <b>84 g</b></li> <li>• SHIS: EC30/25,4-24tpi   EC30/26</li> </ul> <p> <b>A</b> = 22,4 mm            = Innen-Ø des oberen Abschlussrings  <b>B</b> = 30,2 mm            = Außen-Ø der Kugellagerschalen  <b>C</b> = 26,4 mm            = Konussitz auf Gabel         </p>	<b>CARTRIDGE HEAD SET TANGE SEIKI</b> <ul style="list-style-type: none"> <li>• <b>aluminium</b></li> <li>• in box</li> <li>• <b>1"</b>, only <b>84 g</b></li> <li>• SHIS: EC30/25.4-24tpi   EC30/26</li> </ul> <p> <b>A</b> = 22.4 mm            = inner-Ø of the upper cap ring  <b>B</b> = 30.2 mm            = outer-Ø of the bearing shells  <b>C</b> = 26.4 mm            = cone seat on the fork         </p>	
<b>390350</b> silber	silver	
<b>390345</b> schwarz 100 set	black	
<ul style="list-style-type: none"> <li>• <b>1½"</b>, nur <b>106 g</b></li> <li>• SHIS: EC34/28,6-26tpi   EC34/30</li> </ul> <p> <b>A</b> = 25,4 mm  <b>B</b> = 34,0 mm  <b>C</b> = 30,0 mm         </p>	<ul style="list-style-type: none"> <li>• <b>1½"</b>, only <b>106 g</b></li> <li>• SHIS: EC34/28.6-26tpi   EC34/30</li> </ul> <p> <b>A</b> = 25.4 mm  <b>B</b> = 34.0 mm  <b>C</b> = 30.0 mm         </p>	
<b>390353</b> silber	silver	
<b>390346</b> schwarz 100 set	black	

UVP 31,90 €

UVP 31,90 €

ART.-NR. 	BESCHREIBUNG	DESCRIPTION	
<ul style="list-style-type: none"> <li>• <b>390806</b> 100 set</li> </ul>	<p><b>SEMI-INTEGRIERTER CARTRIDGE STEUERSATZ 1 1/8"</b> &gt;ZS44/44 TC&lt;</p> <ul style="list-style-type: none"> <li>• 1 1/8"</li> <li>• schwarz</li> <li>• <b>Aluminium</b></li> <li>• nur 94 g</li> <li>• mit Industriekugellager</li> <li>• SHIS: ZS44/28,6-26T   ZS44/30</li> <li>• im M-Wave Einzelkarton</li> </ul> <p><b>A</b> = 28,6 mm = Innen-Ø des oberen Abschlussrings</p> <p><b>B</b> = 44 mm = Außen-Ø der Kugellagerschalen</p> <p><b>C</b> = 30,0 mm = Konussitz auf Gabel</p>	<p><b>SEMI INTEGRATED CARTRIDGE HEAD SET 1 1/8"</b> &gt;ZS 44/44 TC&lt;</p> <ul style="list-style-type: none"> <li>• 1 1/8"</li> <li>• black</li> <li>• <b>aluminium</b></li> <li>• only 94 g</li> <li>• with sealed bearing</li> <li>• SHIS: ZS44/28.6-26T   ZS44/30</li> <li>• in M-Wave box</li> </ul> <p><b>A</b> = 28.6 mm = inner-Ø of the upper cap ring</p> <p><b>B</b> = 44 mm = outer-Ø of the bearing shells</p> <p><b>C</b> = 30.0 mm = cone seat on the fork</p> <p>UVP 14,90 €</p>	<p><b>SEMI INTEGRATED</b></p> <p><b>M-WAVE</b></p>
<ul style="list-style-type: none"> <li>• <b>390508</b></li> <li>• <b>390509</b> 100/10 set</li> </ul>	<p><b>STEUERSATZ 1 1/8"</b></p> <ul style="list-style-type: none"> <li>• <b>Stahl</b></li> <li>• <b>2-fach gedichtet</b></li> <li>• SHIS: EC34/28,6-26tpi   EC34/30</li> <li>• im Einzelkarton</li> </ul> <p><b>A</b> = 28,6 mm <b>B</b> = 34,0 mm <b>C</b> = 30,0 mm</p> <p>schwarz</p> <p>verchromt</p>	<p><b>HEAD SET 1 1/8"</b></p> <ul style="list-style-type: none"> <li>• <b>steel</b></li> <li>• <b>with 2 sealrings</b></li> <li>• SHIS: EC34/28.6-26tpi   EC34/30</li> <li>• in box</li> </ul> <p><b>A</b> = 28.6 mm <b>B</b> = 34.0 mm <b>C</b> = 30.0 mm</p> <p>black</p> <p>c.p.</p> <p>UVP 5,90 €</p>	
<ul style="list-style-type: none"> <li>• <b>390499</b></li> <li>• <b>390493</b> 100 set</li> </ul>	<p><b>STEUERSATZ 1"</b></p> <ul style="list-style-type: none"> <li>• <b>Stahl</b></li> <li>• <b>2-fach gedichtet</b></li> <li>• verchromt</li> <li>• in Neco Eurolochbox</li> </ul> <p>SHIS: EC30/25,4-24tpi   EC30/26</p> <p><b>A</b> = 25,4 mm <b>B</b> = 30,2 mm <b>C</b> = 26,4 mm</p> <p>SHIS: EC30/25,4-24tpi   EC30/27</p> <p><b>A</b> = 25,4 mm <b>B</b> = 30,0 mm <b>C</b> = 27,0 mm</p>	<p><b>HEAD SET 1"</b></p> <ul style="list-style-type: none"> <li>• <b>steel</b></li> <li>• <b>with 2 sealrings</b></li> <li>• c. p.</li> <li>• in Neco eurohole box</li> </ul> <p>SHIS: EC30/25.4-24tpi   EC30/26</p> <p><b>A</b> = 25.4 mm <b>B</b> = 30.2 mm <b>C</b> = 26.4 mm</p> <p>SHIS: EC30/25.4-24tpi   EC30/27</p> <p><b>A</b> = 25.4 mm <b>B</b> = 30.0 mm <b>C</b> = 27.0 mm</p> <p>UVP 4,90 €</p>	<p><b>nego</b></p>
<ul style="list-style-type: none"> <li>• <b>390423</b></li> <li>• <b>390428</b></li> <li>• <b>390415</b> 100 set</li> </ul>	<p><b>ECO STEUERSATZ 1"</b></p> <ul style="list-style-type: none"> <li>• <b>Stahl</b></li> <li>• 8-teilig</li> <li>• im Einzelkarton</li> </ul> <p>verchromt, SHIS: EC30/25,4-24tpi   EC30/26</p> <p><b>A</b> = 25,4 mm <b>B</b> = 30,2 mm <b>C</b> = 26,4 mm</p> <p>verchromt, SHIS: EC30/25,4-24tpi   EC30/27</p> <p><b>A</b> = 25,4 mm <b>B</b> = 30,0 mm <b>C</b> = 27,0 mm</p> <p>schwarz, SHIS: EC30/25,4-24tpi   EC30/27</p> <p><b>A</b> = 25,4 mm <b>B</b> = 30,0 mm <b>C</b> = 27,0 mm</p>	<p><b>ECO HEAD SET 1"</b></p> <ul style="list-style-type: none"> <li>• <b>steel</b></li> <li>• 8-parts</li> <li>• in box</li> </ul> <p>c.p., SHIS: EC30/25.4-24tpi   EC30/26</p> <p><b>A</b> = 25.4 mm <b>B</b> = 30.2 mm <b>C</b> = 26.4 mm</p> <p>c.p., SHIS: EC30/25.4-24tpi   EC30/27</p> <p><b>A</b> = 25.4 mm <b>B</b> = 30.0 mm <b>C</b> = 27.0 mm</p> <p>black, SHIS: EC30/25.4-24tpi   EC30/27</p> <p><b>A</b> = 25.4 mm <b>B</b> = 30.0 mm <b>C</b> = 27.0 mm</p> <p>UVP 3,90 €</p>	

# FORKS



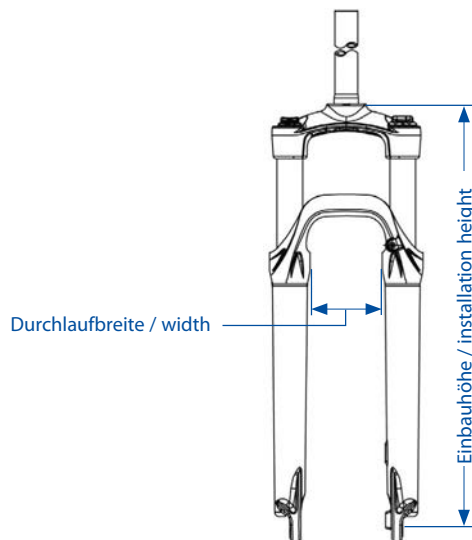

ART.-NR. 	BESCHREIBUNG	DESCRIPTION
--------------	--------------	-------------



<p><b>393400</b> AD 6</p>	<p><b>FEDERGABEL ›868 AMS‹</b> mit <b>15 x 110 mm Steckachse für Boost</b> Federweg: 100 mm Federsystem: Federn und Elastomere <b>einstellbar</b> Tauchrohr: <b>Magnesium</b>, einteilig, 29" Standrohr: <b>Aluminium</b> Brücke: <b>Aluminium</b> für Bremse: Scheibenbremse (PM) Schaft: <b>1 1/8"</b>, 320 mm, ohne Gewinde Reifendurchlaufbreite: max. 82 mm Einbauhöhe: 540 mm Farbe: mattschwarz Verpackung: Montageverpackung</p>	<p><b>SUSPENSION FORK ›868 AMS‹</b> with <b>15 x 110 mm thru axle for boost</b> travel: 100 mm suspension system: <b>adjustable</b> springs and elastomeres lower: <b>magnesium</b>, one-piece, 29" stanchion: <b>aluminium</b> crown: <b>aluminium</b> for brake: disc brake (PM) steerer: <b>1 1/8"</b>, 320 mm, without thread narrowest section: max. 82 mm install. height: 540 mm colour: matt black packaging: OEM UVP 199,00 € UVP mAD 289,00 € <small>Tested by the manufacturer based on ISO 4210 MTB</small></p>	<p><b>29"</b> <b>BOOST</b> </p>
<p><b>395377</b> AD 6</p>	<p><b>FEDERGABEL ›VAXA 30S‹</b> Federweg: 100 mm Federsystem: Federn und MCU-Elastomere <b>einstellbar</b>, mit <b>Lock-Out</b> Funktion Tauchrohr: <b>Magnesium</b>, einteilig, 29" Standrohr: konifiziertes Hi-Ten Brücke: geschmiedetes <b>Aluminium</b> für Bremse: Scheibenbremse (PM) Schaft: 260 mm, ohne Gewinde Reifendurchlaufbreite: max. 60 mm Einbauhöhe: 530 mm Verpackung: Einzelkarton</p>	<p><b>SUSPENSION FORK ›VAXA 30S‹</b> travel: 100 mm suspension system: <b>adjustable</b> springs and MCU elastomeres, with <b>Lock-Out</b> function lower: <b>magnesium</b>, one-piece, 29" stanchion: butted Hi-Ten crown: forged <b>aluminium</b> for brake: disc brake (PM) steerer: 260 mm, without thread narrowest section: max. 60 mm install. height: 530 mm packaging: box <b>1 1/8" - 1.5" tapered</b>, matt black UVP 132,00 € UVP mAD 191,00 € <small>Tested by the manufacturer based on ISO 4210</small></p>	<p><b>29"</b> <b>LOCK-OUT</b> <b>MAGNESIUM</b> </p>
<p><b>395376</b> AD 6</p>	<p><b>1 1/8"</b>, mattschwarz</p>	<p><b>1 1/8"</b>, matt black UVP 121,00 € UVP mAD 175,00 €</p>	



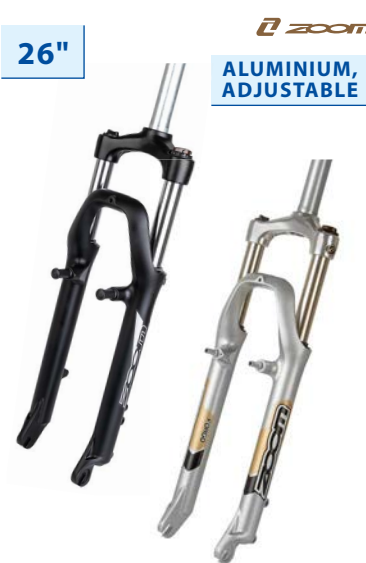

ART.-NR.	BESCHREIBUNG	DESCRIPTION	
<b>395293</b> AD 6	<b>FEDERGABEL ›565D‹</b> Federweg: 80 mm Federsystem: Federn und MCU-Elastomere, <b>einstellbar, mit Lock-Out Funktion</b> Tauchrohr: <b>Aluminium</b> , einteilig, 26" Standrohr: konifizierter Hi-Ten Stahl Brücke: Aluminium Schaft: <b>1 1/8"</b> , 280 mm, Ahead für Bremse: Scheibenbremse (PM) für Reifengr.: 26" Reifendurchlaufbreite: max. 56 mm Einbauhöhe: 480 mm Farbe: mattschwarz Verpackung: Montageverpackung	<b>SUSPENSION FORK ›565D‹</b> travel: 80 mm suspension system: <b>adjustable</b> springs and MCU elastomeres, with <b>Lock-Out function aluminium</b> , one-piece, 26" lower: butted Hi-Ten steel stanchion: aluminium crown: <b>1 1/8"</b> , 280 mm, Ahead steerer: disc brake (PM) for brake: 26" for tire size: narrowest section: max. 56 mm install. height: 480 mm colour: matt black UVP 87,90 € packaging: OEM UVP mAD 127,00 € <small>Tested by the manufacturer based on ISO 4210</small>	 <p><b>LOCK-OUT</b> <b>26"</b></p>
<b>395373</b> AD  <b>395374</b> AD  <b>395375</b> AD 6	<b>FEDERGABEL ›565‹</b> Federweg: 80 mm Federsystem: Federn und MCU-Elastomere <b>einstellbar Aluminium</b> , einteilig, 26" Tauchrohr: konifiziertes Hi-Ten Brücke: geschmiedetes <b>Aluminium</b> für Bremse: V- und Scheibenbremse (IS) Reifendurchlaufbreite: max. 56 mm Einbauhöhe: 480 mm Verpackung: Montageverpackung	<b>SUSPENSION FORK ›565‹</b> travel: 80 mm suspension system: <b>adjustable</b> springs and MCU elastomeres <b>aluminium</b> , one-piece, 26" lower: butted Hi-Ten stanchion: forged <b>aluminium</b> crown: V- and disc brake (IS) for brake: narrowest section: max. 56 mm install. height: 480 mm packaging: OEM UVP 78,90 € UVP mAD 114,00 € <small>Tested by the manufacturer based on ISO 4210</small>	 <p><b>26"</b> <b>ALUMINIUM, ADJUSTABLE</b></p>
<b>396010</b> AD	<b>FEDERGABEL ›BLAST‹, 29", 28", 26", 24", 20"</b> Federweg: 50 mm Federsystem: Elastomere und Federn Tauch- / Standrohr: Stahl Brücke: Stahl für Bremse: V-, Scheibenbremse (IS) Reifendurchlaufbreite: max. 82 mm Einbauhöhe: 495 mm Farbe: schwarz Verpackung: Montageverpackung	<b>SUSPENSION FORK ›BLAST‹, 29", 28", 26", 24", 20"</b> travel: 50 mm suspension system: elastomeres and springs lower / stanchion: steel crown: steel for brake: V-, disc brake (IS) narrowest section: max. 82 mm install. height: 495 mm colour: black packaging: OEM	 <p><b>28/29"</b></p>
<b>396012</b> AD  <b>396013</b> AD	<b>26"</b> , Federweg 40 mm Schaft: <b>1"</b> , 240/85 mm Gewinde Schaft: <b>1 1/8"</b> , 240/85 mm Gewinde	<b>26"</b> , travel 40 mm steerer: <b>1"</b> , 240/85 mm thread steerer: <b>1 1/8"</b> , 240/85 mm thread UVP 33,90 € UVP mAD 48,90 €	<p><b>26"</b></p>
<b>396004</b> AD	<b>24"</b> , Federweg 40 mm Schaft: <b>1"</b> , 220/85 mm Gewinde	<b>24"</b> , travel 40 mm steerer: <b>1"</b> , 220/85 mm thread UVP 33,90 € UVP mAD 48,90 €	<p><b>24"</b></p>
<b>396002</b> AD 10	<b>20"</b> , Federweg 35 mm Schaft: <b>1"</b> , 220/85 mm Gewinde	<b>20"</b> , travel 35 mm steerer: <b>1"</b> , 220/85 mm thread UVP 33,90 € UVP mAD 48,90 €	<p><b>20"</b></p>

ART.-NR.	BESCHREIBUNG	DESCRIPTION	
<b>395219</b> 8	<b>FEDERGABEL ›187D AMS‹ 28"</b> Besonders geeignet für <b>E-Bikes</b>  Federweg: <b>65 mm</b> Federsystem: mit <b>Lock-Out</b> Funktion Tauchrohr: <b>Aluminium, 28"</b> Standrohr: konifiziertes Hi-Ten Brücke: geschmiedetes <b>Aluminium</b> , Aufnahmemöglichkeit für einen Lichthalter nach Suntour-Standard (z.B. Art. 460741) für Bremse: Scheibenbremse (PM) Schaft: 1 1/8", 300 mm, Ahead Reifendurchlaufbreite: max. 56 mm Einbauhöhe: 480 mm Farbe: schwarz Verpackung: Montageverpackung	<b>SUSPENSION FORK ›187D AMS‹ 28"</b> Especially suitable for <b>e-bikes</b>  travel: <b>65 mm</b> suspension system: with <b>Lock-out</b> function lower: <b>aluminium, 28"</b> stanchion: butted Hi-Ten crown: forged <b>aluminium</b> , option for a light holder based on Suntour standard (e.g. art. 460741) for brake: disc brake (PM) steerer: 1 1/8", 300 mm, Ahead narrowest section: max. 56 mm install. height: 480 mm colour: black packaging: OEM	<div style="display: flex; justify-content: space-between; align-items: center;"> <span style="border: 1px solid black; padding: 2px;">28"</span> </div> <div style="text-align: center; margin-top: 20px;"> <p style="color: blue; font-weight: bold; font-size: small;">LOCK-OUT</p> </div> <div style="text-align: right; margin-top: 20px;"> <p>UVP 115,00 €</p> <p style="font-size: x-small; color: blue;">Tested by the manufacturer based on EN 15194</p> </div>
<b>395232</b> AD	<b>FEDERGABEL ›141‹ 28"</b> Federweg: 45 mm Federsystem: Federn und MCU-Elastomere <b>einstellbar</b> Tauchrohr: <b>Aluminium, 28"</b> Standrohr: Stahl Brücke: <b>Aluminium</b> für Bremse: V-, Scheibenbremse (IS) Reifendurchlaufbreite: max. 50 mm Einbauhöhe: 460 mm Befestigungsmöglichkeiten: für Schutzblechstreben, Lowrider, Dynamohalter, Trommelbremsen, Korb, Scheibenbremskabel Farbe: mattschwarz Verpackung: Einzelkarton	<b>SUSPENSION FORK ›141‹ 28"</b> travel: 45 mm suspension system: <b>adjustable</b> springs and MCU elastomeres lower: <b>aluminium, 28"</b> stanchion: steel crown: <b>aluminium</b> for brake: V-, disc brake (IS) narrowest section: max. 50 mm install. height: 460 mm mounting possibilities: for mudguard stays, lowrider, dynamo bracket, drum brake, basket, disc brake cable colour: matt black packaging: box	<div style="display: flex; justify-content: space-between; align-items: center;"> <span style="border: 1px solid black; padding: 2px;">28"</span> </div> <div style="text-align: center; margin-top: 20px;"> <p style="color: blue; font-weight: bold; font-size: small;">LOCK-OUT</p> </div> <div style="text-align: right; margin-top: 20px;"> <p>UVP 89,90 € UVP mAD 129,00 €</p> </div>
<b>395233</b> AD  <b>395234</b> AD 6	<b>ohne Lock-Out</b> Schaft: 215 mm, 60 mm Gewinde  <b>1"</b>  <b>1 1/8"</b>	<b>w/o Lock-out</b> steerer: 215 mm, 60 mm thread  <b>1"</b>  <b>1 1/8"</b>	<div style="text-align: center; margin-top: 20px;"> </div> <div style="text-align: right; margin-top: 20px;"> <p>UVP 78,90 € UVP mAD 114,00 €</p> <p style="font-size: x-small; color: blue;">Tested by the manufacturer based on ISO 4210</p> </div>

ART.-NR.	BESCHREIBUNG	DESCRIPTION
	<b>FEDERGABEL 28"</b> Federweg: 30 mm Federsystem: Elastomere und Feder Tauch- / Standrohr: Stahl, 28" Brücke: <b>Aluminium</b> für Bremse: <b>V-Bremse</b> Schaft: 215 mm, 60 mm Gewinde Reifendurchlaufbreite: max. 50 mm Einbauhöhe: 450 mm Verpackung: Montageverpackung	<b>SUSPENSION FORK 28"</b> travel: 30 mm suspension system: elastomeres and spring lower / stanchion: steel, 28" crown: <b>aluminium</b> for brake: <b>V-brake</b> steerer: 215 mm, 60 mm thread narrowest section: max. 50 mm install. height: 450 mm packaging: OEM
<b>395350</b> AD	1" silber	1" silver UVP 49,90 € UVP mAD 72,00 €
<b>395358</b> AD	1" schwarz	1" black UVP 49,90 € UVP mAD 72,00 €
<b>395351</b> AD	1 1/8" silber	1 1/8" silver UVP 49,90 € UVP mAD 72,00 €
<b>395359</b> AD 6	1 1/8" schwarz	1 1/8" black UVP 49,90 € UVP mAD 72,00 €

ALUMINIUM (LOOK)

28"



Tested by the manufacturer based on ISO 4210

## CARBON

## CARBON

<b>391572</b> 20	<b>RENNRADGABEL</b> ›CAR 1 1/8" - 1,5" FLAT‹ <ul style="list-style-type: none"> <li>• <b>Voll-Carbon UD</b>, unlackiert</li> <li>• <b>innere Zugverlegung</b></li> <li>• passender Steuersatz für innere Zugverlegung Art. 390215</li> <li>• mit <b>Scheibenbremsaufnahme</b> (Flatmount)</li> <li>• <b>oben 1 1/8", unten 1,5"</b> (oberer Schaft-Ø 28,6 mm und Konussitz unten 39,8 mm)</li> <li>• 300 mm Carbon-Ahead-Schaftrohr</li> <li>• Steuersatzauflage-Ø 58,4 mm</li> <li>• Reifendurchlaufbreite max. ca. 50 mm</li> <li>• Einbauhöhe 367 mm</li> <li>• Einbaumaß 100 mm</li> <li>• für <b>12 mm</b> Steckachse</li> <li>• nur <b>411 g</b></li> <li>• Montageverpackung</li> </ul>	<b>ROAD FORK</b> ›CAR 1 1/8" - 1.5" FLAT‹ <ul style="list-style-type: none"> <li>• <b>full carbon UD</b>, unpainted</li> <li>• <b>internal cable routing</b></li> <li>• suitable head set for internal cable routing art. 390215</li> <li>• with <b>disc brake mount</b> (Flatmount)</li> <li>• <b>above 1 1/8", down 1.5"</b> (upper steerer Ø 28.6 mm and down crown race 39.8 mm)</li> <li>• 300 mm carbon Ahead steerer</li> <li>• bearing area Ø 58.4 mm</li> <li>• narrowest section max. approx. 50 mm</li> <li>• installation height 367 mm</li> <li>• OLD 100 mm</li> <li>• for <b>12 mm</b> thru axle</li> <li>• only <b>411 g</b></li> <li>• OEM</li> </ul>
<b>321086</b> 50	<ul style="list-style-type: none"> <li>• passende Steckachse 12 mm</li> <li>• <b>Ausrichtung des Hebels auch in geschlossenem Zustand änderbar</b></li> <li>• M12 x P1,5 x T10,5 x L118,5 mm</li> </ul>	<ul style="list-style-type: none"> <li>• suitable thru axle 12 mm</li> <li>• <b>adjustable position of lever even when closed</b></li> <li>• M12 x P1.5 x T10.5 x L118.5 mm</li> </ul>

FULL CARBON



INTERNAL CABLE ROUTING



UVP 189,00 €







Tested by the manufacturer based on ISO 4210

UVP 34,90 €





# CARBON RENNRAD- / GRAVEL GABELN CARBON ROAD / GRAVEL FORKS



ART.-NR. 	BESCHREIBUNG	DESCRIPTION	
<b>392687</b> 25	<b>GRAVEL GABEL 28" / 27.5"/650 B</b> <ul style="list-style-type: none"> <li>• <b>Voll-Carbon UD</b>, roh</li> <li>• <b>innere Zugverlegung</b></li> <li>• mit <b>Scheibenbremsaufnahme</b> (Flatmount)</li> <li>• <b>oben 1 1/8", unten 1,5"</b></li> <li>• 300 mm Carbon-Ahead-Schaftrohr</li> <li>• Steuersatzauflage-Ø 56 mm</li> <li>• Reifendurchlaufbreite max. ca. 69,8 mm</li> <li>• Einbauhöhe 406 mm</li> <li>• Einbaumaß 100 mm</li> <li>• für <b>12 mm</b> Steckachse</li> <li>• seitliche Ösen zur Schutzblechmontage</li> <li>• nur <b>487 g</b></li> <li>• passend für (Gravel-) Rahmen, z. B. Art. 666141, ...</li> <li>• Montageverpackung</li> </ul>	<b>GRAVEL FORK 28" /27.5"/650 B</b> <ul style="list-style-type: none"> <li>• <b>full carbon UD</b>, raw</li> <li>• <b>internal cable routing</b></li> <li>• with <b>disc brake mount</b> (Flatmount)</li> <li>• <b>above 1 1/8", down 1.5"</b></li> <li>• 300 mm carbon Ahead steerer</li> <li>• bearing area Ø 56 mm</li> <li>• narrowest section max. approx. 69.8 mm</li> <li>• installation height 406 mm</li> <li>• OLD 100 mm</li> <li>• for <b>12 mm</b> thru axle</li> <li>• lateral eyelets for mudguard mounting</li> <li>• only <b>487 g</b></li> <li>• suitable for (Gravel-) frame, e. g. art. 666141, ...</li> <li>• OEM</li> </ul> <p style="text-align: right;">UVP 189,00 €</p> <p style="text-align: right; font-size: small;">Tested by the manufacturer based on ISO 4210</p>	<div style="border: 1px solid blue; padding: 2px; display: inline-block;">FULL CARBON</div> 
<b>321086</b> 50	<ul style="list-style-type: none"> <li>• passende Steckachse 12 mm</li> <li>• <b>Ausrichtung des Hebels auch in geschlossenem Zustand änderbar</b></li> <li>• M12 x P1,5 x T10,5 x L118,5 mm</li> </ul>	<ul style="list-style-type: none"> <li>• suitable thru axle 12 mm</li> <li>• <b>adjustable position of lever even when closed</b></li> <li>• M12 x P1.5 x T10.5 x L118.5 mm</li> </ul> <p style="text-align: right;">UVP 34,90 €</p>	
<b>391531</b> AD 20	<b>RENNRADGABEL</b> ▷CAR 1 1/8" - 1,5"◁ <ul style="list-style-type: none"> <li>• <b>Voll-Carbon UD</b>, mit Klarlack</li> <li>• Aluminium-Ausfallenden</li> <li>• <b>oben 1 1/8", unten 1,5"</b> (oberer Schaft-Ø 28,6 mm und Konussitz unten 39,8 mm)</li> <li>• nur <b>420 g</b></li> <li>• 300 mm Carbon-Ahead-Schaftrohr</li> <li>• Steuersatzauflage-Ø 58 mm</li> <li>• Reifendurchlaufbreite max. ca. 40 mm</li> <li>• Einbauhöhe 370 mm</li> <li>• geeignet für integrierten Steuersatz (z. B. Art. 390365)</li> <li>• Montageverpackung</li> </ul>	<b>ROAD FORK</b> ▷CAR 1 1/8" - 1.5"◁ <ul style="list-style-type: none"> <li>• <b>full carbon UD</b>, with clear varnish</li> <li>• aluminium dropouts</li> <li>• <b>above 1 1/8", down 1.5"</b> (upper steerer Ø 28.6 mm and down crown race 39.8 mm)</li> <li>• only <b>420 g</b></li> <li>• 300 mm carbon Ahead steerer</li> <li>• bearing area Ø 58 mm</li> <li>• narrowest section max. approx. 40 mm</li> <li>• installation height 370 mm</li> <li>• fits for integrated head set (e. g. art. 390365)</li> <li>• OEM</li> </ul> <p style="text-align: right;">UVP 189,00 € UVP mAD 276,00 €</p>	<div style="border: 1px solid blue; padding: 2px; display: inline-block;">FULL CARBON</div>  <div style="border: 1px solid black; padding: 2px; display: inline-block; text-align: center;">  420 g         </div>
<b>392691</b> AD 20	<b>RENNRADGABEL</b> ▷CAR 1 1/8"◁ <ul style="list-style-type: none"> <li>• <b>Voll-Carbon UD</b>, mit Klarlack</li> <li>• <b>1 1/8"</b> (Schaft-Ø 28,6 mm, Konussitz unten 30 mm)</li> <li>• nur <b>550 g</b></li> <li>• 300 mm Carbon-Ahead-Schaftrohr</li> <li>• Steuersatzauflage-Ø 46 mm</li> <li>• Reifendurchlaufbreite max. ca. 20 mm</li> <li>• Einbauhöhe 367 mm</li> <li>• Montageverpackung</li> </ul>	<b>ROAD FORK</b> ▷CAR 1 1/8"◁ <ul style="list-style-type: none"> <li>• <b>full carbon UD</b>, with clear varnish</li> <li>• <b>1 1/8"</b> (upper steerer Ø 28.6 mm, down crown race 30 mm)</li> <li>• only <b>550 g</b></li> <li>• 300 mm carbon Ahead steerer</li> <li>• bearing area Ø 46 mm</li> <li>• narrowest section max. approx. 20 mm</li> <li>• installation height 367 mm</li> <li>• OEM</li> </ul> <p style="text-align: right;">UVP 157,00 € UVP mAD 229,00 €</p>	<div style="border: 1px solid blue; padding: 2px; display: inline-block;">FULL CARBON</div> 

# RENNRAD / TREKKING GABELN ROAD / TREKKING FORKS

ART.-NR.	BESCHREIBUNG	DESCRIPTION	
<b>392683</b> 20	<b>RENNRADGABEL</b> <ul style="list-style-type: none"> <li>• <b>Aluminium</b></li> <li>• 1 1/8"</li> <li>• Schaft 300 mm</li> <li>• <b>Aluminium-Ahead</b> Schaftrohr</li> <li>• designt für integrierten Steuersatz</li> <li>• Steuersatzauflage-Ø 50 mm</li> <li>• geschmiedete Ausfallenden</li> <li>• Reifendurchlaufbreite max. ca. 35 mm</li> <li>• Einbauhöhe 380 mm</li> <li>• schwarz</li> </ul>	<b>ROAD FORK</b> <ul style="list-style-type: none"> <li>• <b>aluminium</b></li> <li>• 1 1/8"</li> <li>• steerer 300 mm</li> <li>• <b>aluminium</b> Ahead steerer</li> <li>• designed for integrated head set</li> <li>• bearing area Ø 50 mm</li> <li>• forged dropouts</li> <li>• narrowest section max. approx. 35 mm</li> <li>• installation height 380 mm</li> <li>• black</li> </ul>	
		UVP 143,00 € <small>Tested by the manufacturer based on ISO 4210</small>	
<b>392873</b> 20	<b>RENNRADGABEL</b> <ul style="list-style-type: none"> <li>• <b>CrMo</b></li> <li>• 1" (Konus 26,4 mm)</li> <li>• Schaft 240 mm</li> <li>• 130 mm Gewinde</li> <li>• <b>geschmiedete</b> Ausfallenden</li> <li>• Reifendurchlaufbreite max. ca. 40 mm</li> <li>• Einbauhöhe 370 mm</li> <li>• verchromt</li> </ul>	<b>ROAD FORK</b> <ul style="list-style-type: none"> <li>• <b>CrMo</b></li> <li>• 1" (cone 26.4 mm)</li> <li>• steerer 240 mm</li> <li>• 130 mm thread</li> <li>• <b>forged</b> dropouts</li> <li>• narrowest section max. approx. 40 mm</li> <li>• installation height 370 mm</li> <li>• c.p.</li> </ul>	
		UVP 69,90 €	
<b>392806</b> 20	<b>GABEL</b> <ul style="list-style-type: none"> <li>• <b>700C</b></li> <li>• auch geeignet für <b>Singlespeed Rahmen</b></li> <li>• Ahead-Schaftrohr 300 mm, 1 1/8"</li> <li>• Reifendurchlaufbreite max. ca. 60 mm</li> <li>• Einbauhöhe 390 mm</li> <li>• Stahl</li> <li>• roh, phosphatiert</li> </ul>	<b>FORK</b> <ul style="list-style-type: none"> <li>• <b>700C</b></li> <li>• also suitable for <b>Singlespeed frame</b></li> <li>• Ahead steerer 300 mm, 1 1/8"</li> <li>• narrowest section max. approx. 60 mm</li> <li>• installation height 390 mm</li> <li>• steel</li> <li>• raw, phosphated</li> </ul>	
		UVP 19,90 €	



## TREKKING

## TREKKING

<b>393250</b> 10 	<b>E-BIKE GABEL 28"/29"</b> <ul style="list-style-type: none"> <li>• <b>Aluminium 7005</b></li> <li>• Ahead Schaftrohr 285 mm, verjüngt, 1 1/8" - 1,5"</li> <li>• mit Scheibenbremsaufnahme (PM)</li> <li>• mit Gepäckträgerösen</li> <li>• mit zwei Kabelführungsanlötteilen</li> <li>• Steuersatzauflage Ø 62 mm</li> <li>• Einbaumaß 100 mm</li> <li>• <b>zum Niveaueausgleich beim Ersatz einer Federgabel</b></li> <li>• roh</li> <li>• Reifendurchlaufbreite max. ca. 70 mm</li> <li>• Einbauhöhe 460 mm</li> </ul>	<b>E-BIKE FORK 28"/29"</b> <ul style="list-style-type: none"> <li>• <b>aluminum 7005</b></li> <li>• Ahead steerer 285 mm, tapered, 1 1/8" - 1.5"</li> <li>• for disc brake mount (PM)</li> <li>• with eyelets for carrier</li> <li>• with two cable guide bosses</li> <li>• bearing area Ø 62 mm</li> <li>• OLD 100 mm</li> <li>• <b>for levelling when replacing a suspension fork</b></li> <li>• raw</li> <li>• narrowest section max. approx. 70 mm</li> <li>• installation height 460 mm</li> </ul>	<small>according to DIN EN 15194</small> 
		UVP 167,00 €	

ART.-NR.	BESCHREIBUNG	DESCRIPTION	
<b>TREKKING</b>		<b>TREKKING</b>	
<b>391552</b> 12	<b>E-BIKE / TREKKINGGABEL 28"</b> <ul style="list-style-type: none"> <li>• <b>Aluminium 7005</b></li> <li>• CrMo Ahead Schaftrohr 285 mm, 1 1/8"</li> <li>• mit Scheibenbremsaufnahme (PM)</li> <li>• mit Gepäckträgerösen</li> <li>• mit Kabelführungsanlötteil</li> <li>• Steuersatzauflage Ø 50 mm</li> <li>• Einbaumaß 100 mm</li> <li>• roh</li> <li>• Reifendurchlaufbreite max. ca. 68 mm</li> <li>• Einbauhöhe 430 mm</li> <li>• passend für Rahmen Art. 660370, ...</li> </ul>	<b>E-BIKE / TREKKING FORK 28"</b> <ul style="list-style-type: none"> <li>• <b>aluminum 7005</b></li> <li>• CrMo Ahead steerer 285 mm, 1 1/8"</li> <li>• for disc brake mount (PM)</li> <li>• with eyelets for carrier</li> <li>• with cable guide boss</li> <li>• bearing area Ø 50 mm</li> <li>• OLD 100 mm</li> <li>• raw</li> <li>• narrowest section max. approx. 68 mm</li> <li>• installation height 430 mm</li> <li>• suitable for frames art. 660370, ...</li> </ul>	
<b>392933</b> AD          <b>392940</b> AD <b>NEW</b>	<b>TREKKINGGABEL</b> <ul style="list-style-type: none"> <li>• <b>Aluminium 6061</b></li> <li>• <b>1 1/8"</b></li> <li>• mit 280 mm <b>Aluminium</b> Schaft ohne Gewinde (für Ahead)</li> <li>• Einbauhöhe <b>40 mm höher</b> als Standard</li> <li>• <b>für V- und Scheibenbremse</b></li> <li>• mit <b>Gepäckträgerösen</b></li> <li>• mattschwarz</li> </ul> <b>zum Niveaueausgleich beim Ersatz einer Federgabel</b>  <ul style="list-style-type: none"> <li>• <b>28"</b></li> <li>• Reifendurchlaufbreite max. ca. 60 mm</li> <li>• Einbauhöhe 450 mm</li> </ul>  <ul style="list-style-type: none"> <li>• <b>26"</b></li> <li>• Reifendurchlaufbreite max. ca. 69,5 mm</li> <li>• Einbauhöhe 453 mm</li> </ul>	<b>TREKKING FORK</b> <ul style="list-style-type: none"> <li>• <b>aluminium 6061</b></li> <li>• <b>1 1/8"</b></li> <li>• with 280 mm <b>aluminium</b> steerer without thread (for Ahead)</li> <li>• installation height <b>40 mm higher</b> than standard</li> <li>• <b>for V- and disc brake mount</b></li> <li>• with <b>eyelets for carrier</b></li> <li>• matt black</li> </ul> <b>for levelling when replacing a suspension fork</b>  <ul style="list-style-type: none"> <li>• <b>28"</b></li> <li>• narrowest section max. approx. 60 mm</li> <li>• installation height 450 mm</li> </ul> <p style="text-align: right;">UVP 68,90 € UVP mAD 99,00 €</p>  <ul style="list-style-type: none"> <li>• <b>26"</b></li> <li>• narrowest section approx. 69.5 mm</li> <li>• installation height 453 mm</li> </ul> <p style="text-align: right;">UVP 66,90 € UVP mAD 97,00 €</p>	 
<b>392930</b> AD 20	<ul style="list-style-type: none"> <li>• <b>28"</b></li> <li>• Reifendurchlaufbreite max. ca. 60 mm</li> <li>• Einbauhöhe 410 mm</li> </ul>	<ul style="list-style-type: none"> <li>• <b>28"</b></li> <li>• narrowest section max. approx. 60 mm</li> <li>• installation height 410 mm</li> </ul> <p style="text-align: right;">UVP 69,90 € UVP mAD 101,00 €</p>	
<b>392855</b> AD 20	<b>TREKKINGGABEL 28"</b> <ul style="list-style-type: none"> <li>• Hi-Ten</li> <li>• Oversize <b>1 1/8"</b></li> <li>• mit Anlötteil für Low Rider</li> <li>• für V- und <b>Scheibenbremse</b> (IS)</li> <li>• Schaft 240 mm</li> <li>• Gewinde 130 mm</li> <li>• schwarz</li> <li>• Reifendurchlaufbreite max. ca. 60 mm</li> <li>• Einbauhöhe 420 mm</li> </ul>	<b>TREKKING FORK 28"</b> <ul style="list-style-type: none"> <li>• Hi-Ten</li> <li>• oversize <b>1 1/8"</b></li> <li>• with bosses for low rider</li> <li>• for V- and <b>disc brake</b> (IS)</li> <li>• steerer 240 mm</li> <li>• thread 130 mm</li> <li>• black</li> <li>• narrowest section max. approx. 60 mm</li> <li>• install. height 420 mm</li> </ul> <p style="text-align: right;">UVP 22,90 € UVP mAD 32,90 €</p>	

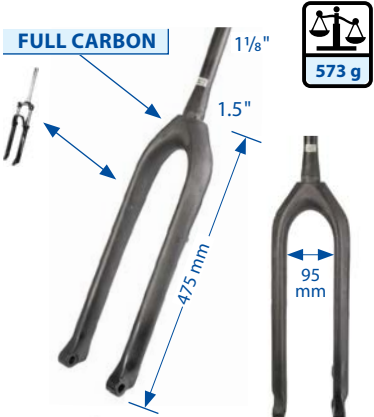
# TREKKING / MTB GABELN TREKKING / MTB FORKS

ART.-NR.	BESCHREIBUNG	DESCRIPTION	
<b>TREKKING</b>		<b>TREKKING</b>	
	<b>TREKKINGGABEL 28"</b> <ul style="list-style-type: none"> <li>• Hi-Ten</li> <li>• 1" (Konus 26,4 mm)</li> <li>• Schaft 240 mm</li> <li>• Gewinde 130 mm</li> <li>• Reifendurchlaufbreite max. ca. 75 mm</li> <li>• Einbauhöhe 380 mm</li> <li>• mit <b>Gepäckträgerösen</b></li> <li>• Stahl</li> </ul>	<b>TREKKING FORK 28"</b> <ul style="list-style-type: none"> <li>• Hi-Ten</li> <li>• 1" (cone 26.4 mm)</li> <li>• steerer 240 mm</li> <li>• thread 130 mm</li> <li>• narrowest section max. approx. 75 mm</li> <li>• installation height 380 mm</li> <li>• with <b>eyelets for carrier</b></li> <li>• steel</li> </ul>	
<b>392852</b> AD	schwarz	black	UVP 19,90 € UVP mAD 28,90 €
<b>392850</b> AD 20	verchromt	c. p.	UVP 23,90 € UVP mAD 34,90 €
<b>MTB</b>		<b>MTB</b>	
<b>395040</b> 10	<b>MTB GABEL</b> <ul style="list-style-type: none"> <li>• <b>Voll-Carbon UD</b>, unlackiert</li> <li>• <b>Federgabelgeometrie</b></li> <li>• mit Scheibenbremsaufnahme (PM)</li> <li>• für 27,5" - 29" Reifen</li> <li>• Schaft: 1 1/8" - 1,5" verjüngt</li> <li>• 300 mm Carbon-Ahead-Schaftrohr</li> <li>• Steuersatzauflage-Ø 57 mm</li> <li>• für <b>15 mm Steckachse</b></li> <li>• Reifendurchlaufbreite max. ca. 95 mm</li> <li>• Einbauhöhe 475 mm</li> <li>• Einbaumaß 100 mm</li> <li>• nur <b>573 g</b></li> <li>• Montageverpackung</li> </ul>	<b>MTB FORK</b> <ul style="list-style-type: none"> <li>• <b>full carbon UD</b>, unpainted</li> <li>• <b>suspension fork geometry</b></li> <li>• with disc brake mount (PM)</li> <li>• for 27.5" - 29" tires</li> <li>• steerer: 1 1/8" - 1.5" tapered</li> <li>• 300 mm carbon Ahead steerer</li> <li>• bearing area Ø 57 mm</li> <li>• for <b>15 mm thru axle</b></li> <li>• narrowest section max. approx. 95 mm</li> <li>• installation height 475 mm</li> <li>• OLD 100 mm</li> <li>• only <b>573 g</b></li> <li>• OEM</li> </ul>	
			UVP 292,00 € <small>Tested by the manufacturer based on ISO 4210</small>
<b>321097</b> 50	<ul style="list-style-type: none"> <li>• passende Steckachse 15 mm</li> <li>• <b>Ausrichtung des Hebels auch in geschlossenem Zustand änderbar</b></li> <li>• M15 x P1,5 x T10,0 x L148 mm</li> <li>• auch passend für Rock Shox</li> </ul>	<ul style="list-style-type: none"> <li>• suitable thru axle 15 mm</li> <li>• <b>adjustable position of lever even when closed</b></li> <li>• M15 x P1.5 x T10.0 x L148 mm</li> <li>• also suitable for Rock Shox</li> </ul>	
			UVP 34,90 €
<b>392074</b> AD	<b>MTB GABEL</b> <ul style="list-style-type: none"> <li>• 1" (Konus 26,4 mm)</li> <li>• Schaft 240 mm</li> <li>• Gewinde 130 mm</li> </ul> <b>20"</b> <ul style="list-style-type: none"> <li>• schwarz</li> <li>• Reifendurchlaufbreite max. ca. 68 mm</li> <li>• Einbauhöhe 320 mm</li> </ul>	<b>MTB FORK</b> <ul style="list-style-type: none"> <li>• 1" (cone 26.4 mm)</li> <li>• steerer 240 mm</li> <li>• thread 130 mm</li> </ul> <b>20"</b> <ul style="list-style-type: none"> <li>• black</li> <li>• narrowest section max. approx. 68 mm</li> <li>• installation height 320 mm</li> </ul>	
<b>392474</b> AD	<b>24"</b> <ul style="list-style-type: none"> <li>• schwarz</li> <li>• Reifendurchlaufbreite max. ca. 68 mm</li> <li>• Einbauhöhe 375 mm</li> </ul>	<b>24"</b> <ul style="list-style-type: none"> <li>• black</li> <li>• narrowest section max. approx. 68 mm</li> <li>• installation height 375 mm</li> </ul>	UVP 18,90 € UVP mAD 27,00 €
<b>392775</b> AD	<b>26"</b> <ul style="list-style-type: none"> <li>• Reifendurchlaufbreite max. ca. 90 mm</li> <li>• Einbauhöhe 390 mm</li> </ul>	<b>26"</b> <ul style="list-style-type: none"> <li>• narrowest section max. approx. 90 mm</li> <li>• installation height 390 mm</li> </ul>	UVP 23,90 € UVP mAD 34,90 €
<b>392776</b> AD 20	schwarz	black	UVP 18,90 € UVP mAD 27,00 €
<b>392778</b> AD 20	<b>Oversize 1 1/8"</b> <ul style="list-style-type: none"> <li>• <b>26"</b></li> <li>• schwarz</li> <li>• 130 mm Gewinde</li> <li>• Reifendurchlaufbreite max. ca. 70 mm</li> <li>• Einbauhöhe 400 mm</li> </ul>	<b>Oversize 1 1/8"</b> <ul style="list-style-type: none"> <li>• <b>26"</b></li> <li>• black</li> <li>• 130 mm thread</li> <li>• narrowest section max. approx. 70 mm</li> <li>• installation height 400 mm</li> </ul>	UVP 19,90 € UVP mAD 28,90 €



# FAT BIKE / BMX / RETRO GABELN FAT BIKE / BMX / RETRO FORKS

ART.-NR.	BESCHREIBUNG	DESCRIPTION	
<b>FAT BIKE</b>		<b>FAT BIKE</b>	
<b>392610</b> AD 20	<b>FAT TIRE / SNOW BIKE GABEL 26"</b> <ul style="list-style-type: none"> <li>• Hi-Ten</li> <li>• Nabeneinbaumaß: <b>135 mm</b></li> <li>• Ahead-Schaft <b>1 1/8"</b>, 219 mm</li> <li>• für Scheibenbremse (IS)</li> <li>• Reifendurchlaufbreite max. ca. 124 mm</li> <li>• Einbauhöhe 430 mm</li> <li>• schwarz</li> </ul>	<b>FAT TIRE / SNOW BIKE FORK 26"</b> <ul style="list-style-type: none"> <li>• Hi-Ten</li> <li>• OLD: <b>135 mm</b></li> <li>• Ahead steerer <b>1 1/8"</b>, 219 mm</li> <li>• for disc brake (IS)</li> <li>• narrowest section max. approx. 124 mm</li> <li>• installation height 430 mm</li> <li>• black</li> </ul>	
		UVP 31,90 € UVP mAD 46,00 €	
<b>BMX</b>		<b>BMX</b>	
<b>393150</b> AD 20	<b>BMX GABEL</b> <ul style="list-style-type: none"> <li>• <b>20"</b></li> <li>• Stahl</li> <li>• Schaft: 180 mm, <b>Upsize 1 1/8" Ahead</b>, ohne Gewinde</li> <li>• für V-Brake</li> <li>• Reifendurchlaufbreite max. ca. 80 mm</li> <li>• Einbauhöhe 320 mm</li> <li>• schwarz</li> <li>• Montageverpackung</li> </ul>	<b>BMX FORK</b> <ul style="list-style-type: none"> <li>• <b>20"</b></li> <li>• steel</li> <li>• steerer: 180 mm, <b>upsized 1 1/8" Ahead</b>, w/o thread</li> <li>• for V-brake</li> <li>• narrowest section max. approx. 80 mm</li> <li>• installation height 320 mm</li> <li>• black</li> <li>• OEM</li> </ul>	
		UVP 19,90 € UVP mAD 28,90 €	
<b>RETRO</b>		<b>RETRO</b>	
<b>392879</b> AD 20	<b>GABELN</b> <ul style="list-style-type: none"> <li>• Schaft 240 mm</li> <li>• Gewinde 130 mm</li> <li>• mit Dynamohalter rechts</li> </ul> <ul style="list-style-type: none"> <li>• <b>mit Tourenende</b></li> <li>• <b>28" x 1,75"</b></li> <li>• Reifendurchlaufbreite max. ca. 60 mm</li> <li>• Einbauhöhe 400 mm</li> <li>• schwarz</li> </ul>	<b>FORKS</b> <ul style="list-style-type: none"> <li>• steerer 240 mm</li> <li>• thread 130 mm</li> <li>• with dynamo bracket right</li> </ul> <ul style="list-style-type: none"> <li>• <b>with touring end</b></li> <li>• <b>28" x 1.75"</b></li> <li>• narrowest section max. approx. 60 mm</li> <li>• installation height 400 mm</li> <li>• black</li> </ul>	
		UVP 19,90 € UVP mAD 28,90 €	
<b>392763</b> AD	<b>mit Sportende, 2 Ösen</b> <ul style="list-style-type: none"> <li>• <b>27" x 1 1/4"</b> und <b>28" x 1 3/8" x 1 5/8"</b></li> <li>• Reifendurchlaufbreite max. ca. 65 mm</li> <li>• Einbauhöhe 390 mm</li> <li>• verchromt</li> </ul>	<b>with semi forged end, 2 eyelets</b> <ul style="list-style-type: none"> <li>• <b>27" x 1 1/4"</b> and <b>28" x 1 3/8" x 1 5/8"</b></li> <li>• narrowest section max. approx. 65 mm</li> <li>• installation height 390 mm</li> <li>• c. p.</li> </ul>	
<b>392872</b> AD 20	<ul style="list-style-type: none"> <li>• <b>28" x 1,75"</b></li> <li>• Reifendurchlaufbreite max. ca. 58 mm</li> <li>• Einbauhöhe 385 mm</li> <li>• verchromt</li> </ul>	<ul style="list-style-type: none"> <li>• <b>28" x 1.75"</b></li> <li>• narrowest section max. approx. 58 mm</li> <li>• installation height 385 mm</li> <li>• c. p.</li> </ul>	
		UVP 23,90 € UVP mAD 34,90 €	



# HANDLE- BARS

ART.-NR.	BESCHREIBUNG	DESCRIPTION
----------	--------------	-------------

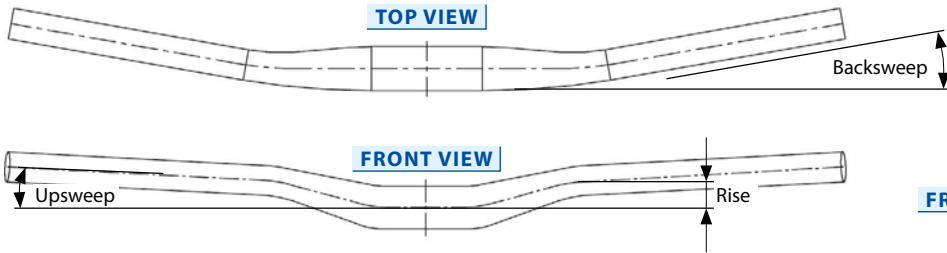

<p><b>401516</b> <b>401517</b></p> <p>40</p>	<p><b>MTB LENKER</b> ›HB-M3.1‹</p> <ul style="list-style-type: none"> <li>• Aluminium</li> <li>• konifiziert</li> <li>• 780 mm</li> <li>• mattschwarz</li> <li>• für Klemmung <b>Ø 31,8 mm</b></li> <li>• 9° nach hinten gebogen</li> <li>• 0° nach oben gebogen</li> <li>• Höhe 5 mm</li> <li>• mit Skala in der Mitte und an den Seiten</li> </ul> <p>auf M-Wave Eurolochkarte</p> <p>Montageverpackung</p>	<p><b>MTB HANDLEBAR</b> ›HB-M3.1‹</p> <ul style="list-style-type: none"> <li>• aluminium</li> <li>• butted</li> <li>• 780 mm</li> <li>• matt black</li> <li>• bar center <b>Ø 31.8 mm</b></li> <li>• 9° backsweep</li> <li>• 0° upsweep</li> <li>• rise 5 mm</li> <li>• with scale in the middle and at the sides</li> </ul> <p>on M-Wave eurohole card</p> <p>OEM</p> <p>UVP 18,90 €</p>	<p>Tested by the manufacturer based on ISO 4210</p>
--	---	---	---

<p><b>401501</b> <b>401502</b></p> <p>40</p> <p>30</p>	<p><b>MTB LENKER</b> ›FLAT ON TOP-29"‹</p> <ul style="list-style-type: none"> <li>• Aluminium</li> <li>• konifiziert</li> <li>• mattschwarz</li> <li>• für Klemmung <b>Ø 31,8 mm</b></li> <li>• 9° nach hinten gebogen</li> <li>• mit Skala an den Seiten</li> <li>• auf Zoom Eurolochkarte</li> </ul> <p><b>780 mm</b></p> <p><b>680 mm</b></p>	<p><b>MTB HANDLEBAR</b> ›FLAT ON TOP-29"‹</p> <ul style="list-style-type: none"> <li>• aluminium</li> <li>• butted</li> <li>• matt black</li> <li>• bar center <b>Ø 31.8 mm</b></li> <li>• 9° backsweep</li> <li>• with scale at the sides</li> <li>• on Zoom eurohole card</li> </ul> <p><b>780 mm</b></p> <p><b>680 mm</b></p> <p>UVP 17,90 €</p>	<p>Tested by the manufacturer based on ISO 4210</p> <p><b>FLAT ON TOP</b></p>
--	--	---	---

<p><b>401500</b> <b>401530</b></p> <p><b>NEW</b></p> <p>50</p>	<p><b>MTB LENKER</b></p> <ul style="list-style-type: none"> <li>• Aluminium</li> <li>• konifiziert</li> <li>• mattschwarz</li> <li>• für Klemmung <b>Ø 31,8 mm</b></li> <li>• nur <b>240 g</b></li> <li>• mit Skala in der Mitte und an den Seiten</li> </ul> <p>• <b>620 mm</b></p> <p>• 10° nach hinten gebogen</p> <p>auf Zoom Eurolochkarte</p> <p>Montageverpackung</p>	<p><b>MTB HANDLEBAR</b></p> <ul style="list-style-type: none"> <li>• aluminium</li> <li>• butted</li> <li>• matt black</li> <li>• bar center <b>Ø 31.8 mm</b></li> <li>• only <b>240 g</b></li> <li>• with scale in the middle and at the sides</li> </ul> <p>• <b>620 mm</b></p> <p>• 10° backsweep</p> <p>on Zoom eurohole card</p> <p>OEM</p> <p>UVP 15,90 €</p>	<p>Tested by the manufacturer based on ISO 4210</p>
--	--	---	---

<p>• <b>403207</b> AD 50</p>	<ul style="list-style-type: none"> <li>• M-Wave</li> <li>• <b>680 mm</b></li> <li>• 6° nach hinten gebogen</li> <li>• Montageverpackung</li> </ul>	<ul style="list-style-type: none"> <li>• M-Wave</li> <li>• <b>680 mm</b></li> <li>• 6° backsweep</li> <li>• OEM</li> </ul> <p>UVP 8,90 €</p> <p>UVP mAD 12,90 €</p>	
--------------------------------------	--	---	--



ART.-NR.	BESCHREIBUNG	DESCRIPTION	
	<b>MTB LENKER</b> <ul style="list-style-type: none"> <li>• Aluminium</li> <li>• konifiziert</li> <li>• 620 mm</li> <li>• für Klemmung Ø 25,4 mm</li> <li>• 6° nach hinten gebogen</li> <li>• nur 229 g</li> <li>• Montageverpackung</li> </ul>	<b>MTB HANDLEBAR</b> <ul style="list-style-type: none"> <li>• aluminium</li> <li>• butted</li> <li>• 620 mm</li> <li>• bar center Ø 25.4 mm</li> <li>• 6° backsweep</li> <li>• only 229 g</li> <li>• OEM</li> </ul>	<div style="border: 1px solid black; padding: 2px; font-size: 8px;">Tested by the manufacturer based on ISO 4210</div>
403958 AD	mattschwarz	matt black	
403964 AD 50	silber	silver	
			UVP 11,90 € UVP mAD 17,90 €
	<b>MTB LENKER</b> <ul style="list-style-type: none"> <li>• Aluminium</li> <li>• 620 mm breit</li> <li>• für Klemmung Ø 25,4 mm</li> <li>• Montageverpackung</li> </ul>	<b>MTB HANDLEBAR</b> <ul style="list-style-type: none"> <li>• aluminium</li> <li>• width 620 mm</li> <li>• bar center Ø 25.4 mm</li> <li>• OEM</li> </ul>	
403684 AD	schwarz	black	
403685 AD 50	silber	silver	
			UVP 7,90 € UVP mAD 11,90 €
403686 AD 50	<ul style="list-style-type: none"> <li>• Stahl</li> <li>• 600 mm</li> <li>• für Klemmung Ø 25,4 mm</li> <li>• schwarz</li> </ul>	<ul style="list-style-type: none"> <li>• steel</li> <li>• 600 mm</li> <li>• bar center Ø 25.4 mm</li> <li>• black</li> </ul>	
			UVP 4,90 € UVP mAD 6,90 €
	<b>MTB RISE LENKER</b> ›HB-M4.1‹ <ul style="list-style-type: none"> <li>• Aluminium</li> <li>• doppelt konifiziert</li> <li>• 780 mm</li> <li>• mattschwarz</li> <li>• für Klemmung Ø 31,8 mm</li> <li>• 7° nach hinten gebogen</li> <li>• mit Skala in der Mitte und an den Seiten</li> </ul>	<b>MTB RISE HANDLEBAR</b> ›HB-M4.1‹ <ul style="list-style-type: none"> <li>• aluminium</li> <li>• double butted</li> <li>• 780 mm</li> <li>• matt black</li> <li>• bar center Ø 31.8 mm</li> <li>• 7° backsweep</li> <li>• with scale in the middle and at the sides</li> </ul>	<div style="border: 1px solid black; padding: 2px; font-size: 8px;">Tested by the manufacturer based on ISO 4210</div>
	Höhe 10 mm, 4° nach oben gebogen	rise 10 mm, 4° upsweep	
403225	auf M-Wave Eurolochkarte	on M-Wave eurohole card	
403227	Montageverpackung	OEM	
	Höhe 20 mm, 3° nach oben gebogen	rise 20 mm, 3° upsweep	
403226	auf M-Wave Eurolochkarte	on M-Wave eurohole card	
403228	Montageverpackung	OEM	
			UVP 49,90 €



ART.-NR.	BESCHREIBUNG	DESCRIPTION	
<b>403630</b> AD 25	<b>MTB RISE LENKER</b> <b>›A-RISE 780 OVERSIZE‹</b> <ul style="list-style-type: none"> <li>• Aluminium</li> <li>• 780 mm</li> <li>• für Klemmung <math>\varnothing</math> 35 mm</li> <li>• 9° nach hinten gebogen</li> <li>• 3° nach oben gebogen</li> <li>• <b>Höhe 20 mm</b></li> <li>• mit Skala in der Mitte und an den Seiten</li> <li>• schwarz</li> <li>• auf M-Wave Eurolochkarte</li> </ul>	<b>MTB RISE HANDLEBAR</b> <b>›A-RISE 780 OVERSIZE‹</b> <ul style="list-style-type: none"> <li>• aluminium</li> <li>• 780 mm</li> <li>• bar center <math>\varnothing</math> 35 mm</li> <li>• 9° backsweep</li> <li>• 3° upsweep</li> <li>• <b>rise 20 mm</b></li> <li>• with scale in the middle and at the sides</li> <li>• black</li> <li>• on M-Wave eurohole card</li> </ul>	<div style="border: 1px solid black; padding: 2px; font-size: 8px;">Tested by the manufacturer based on ISO 4210</div>
<b>401518</b> auf M-Wave Eurolochkarte 20 <b>401519</b> Montageverpackung 50 <b>401529</b> auf M-Wave Eurolochkarte 40 <b>401524</b> Montageverpackung 50	<b>MTB RISE LENKER</b> <b>›HB-M3.2‹</b> <ul style="list-style-type: none"> <li>• Aluminium</li> <li>• <b>doppelt konifiziert</b></li> <li>• mattschwarz</li> <li>• für Klemmung <math>\varnothing</math> 31,8 mm</li> <li>• 9° nach hinten gebogen</li> <li>• 3° nach oben gebogen</li> <li>• <b>Höhe 20 mm</b></li> <li>• mit Skala in der Mitte und an den Seiten</li> </ul> <p><b>780 mm</b></p> <p><b>680 mm</b></p>	<b>MTB RISE HANDLEBAR</b> <b>›HB-M3.2‹</b> <ul style="list-style-type: none"> <li>• aluminium</li> <li>• <b>double butted</b></li> <li>• matt black</li> <li>• bar center <math>\varnothing</math> 31.8 mm</li> <li>• 9° backsweep</li> <li>• 3° upsweep</li> <li>• <b>rise 20 mm</b></li> <li>• with scale in the middle and at the sides</li> </ul> <p><b>780 mm</b></p> <p>on M-Wave eurohole card</p> <p>OEM</p> <p><b>680 mm</b></p> <p>on M-Wave eurohole card</p> <p>OEM</p>	<div style="border: 1px solid black; padding: 2px; font-size: 8px;">Tested by the manufacturer based on ISO 4210</div>
 <b>401505</b> 40 <b>401506</b> 30	<b>MTB RISE LENKER</b> <ul style="list-style-type: none"> <li>• Aluminium</li> <li>• <b>konifiziert</b></li> <li>• mattschwarz</li> <li>• für Klemmung <math>\varnothing</math> 31,8 mm</li> <li>• 9° nach hinten gebogen</li> <li>• mit <b>Skala</b> in der Mitte und an den Seiten</li> <li>• auf Zoom Eurolochkarte</li> </ul> <p><b>Höhe 20 mm, 3° nach oben gebogen</b></p>	<b>MTB RISE HANDLEBAR</b> <ul style="list-style-type: none"> <li>• aluminium</li> <li>• <b>butted</b></li> <li>• matt black</li> <li>• bar center <math>\varnothing</math> 31.8 mm</li> <li>• 9° backsweep</li> <li>• with <b>scale</b> in the middle and at the sides</li> <li>• on Zoom eurohole card</li> </ul> <p><b>rise 20 mm, 3° upsweep</b></p>	<div style="border: 1px solid black; padding: 2px; font-size: 8px;">Tested by the manufacturer based on ISO 4210</div>
<b>401503</b> 30 <b>401504</b> 50	<ul style="list-style-type: none"> <li>• <b>Höhe 30 mm, 5° nach oben gebogen</b></li> <li>• <b>620 mm</b></li> </ul>	<ul style="list-style-type: none"> <li>• <b>rise 30 mm, 5° upsweep</b></li> <li>• <b>620 mm</b></li> </ul>	



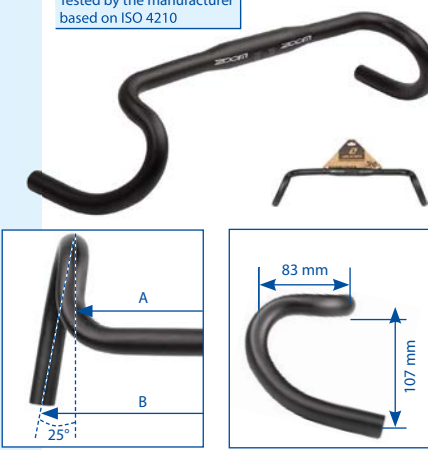
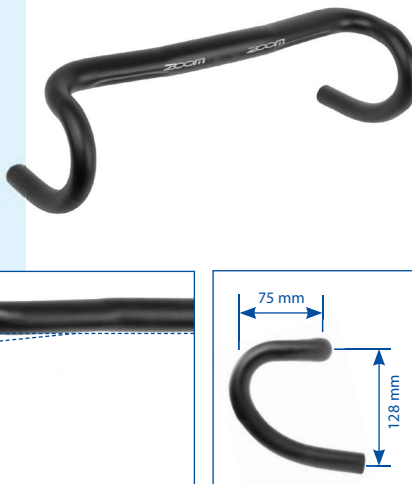

ART.-NR. 	BESCHREIBUNG	DESCRIPTION	
<p><b>403500</b></p> <p><b>403501</b></p>	<p><b>MTB RISE LENKER</b> <b>&gt;A-RISE 700C&lt;</b></p> <ul style="list-style-type: none"> <li>• <b>Aluminium</b></li> <li>• <b>konifiziert</b></li> <li>• <b>700 mm</b></li> <li>• Klemmung <b>Ø 31,8 mm</b></li> <li>• 10° nach hinten gebogen</li> <li>• 16° nach oben gebogen</li> <li>• Höhe 30 mm</li> <li>• nur 297 g</li> <li>• mit <b>Skala</b> in der Mitte und an den Seiten</li> </ul> <p>auf M-Wave Eurolochkarte</p> <p>mattschwarz eloxiert</p> <p>silber eloxiert</p>	<p><b>MTB RISE HANDLEBAR</b> <b>&gt;A-RISE 700C&lt;</b></p> <ul style="list-style-type: none"> <li>• <b>aluminium</b></li> <li>• <b>butted</b></li> <li>• <b>700 mm</b></li> <li>• bar center <b>Ø 31.8 mm</b></li> <li>• 10° backsweep</li> <li>• 16° upsweep</li> <li>• rise 30 mm</li> <li>• only 297 g</li> <li>• with <b>scale</b> in the middle and at the sides</li> </ul> <p>on M-Wave eurohole card</p> <p>matt black anodised</p> <p>silver anodised</p> <p>UVP 19,90 €</p>	<p>Tested by the manufacturer based on ISO 4210</p>
<ul style="list-style-type: none"> <li>• <b>403664</b> AD</li> <li>• <b>403502</b> AD 50</li> </ul>	<p>Montageverpackung</p> <p>mattschwarz eloxiert</p> <p>silber eloxiert</p>	<p>OEM</p> <p>matt black anodised</p> <p>silver anodised</p> <p>UVP 19,90 € UVP mAD 28,90 €</p>	
<p><b>403220</b> AD</p> <p><b>403221</b> AD 30</p>	<p><b>MTB RISE LENKER</b></p> <ul style="list-style-type: none"> <li>• <b>Aluminium</b></li> <li>• <b>konifiziert</b></li> <li>• 620 mm</li> <li>• Klemmung <b>Ø 25,4 mm</b></li> <li>• 10° nach hinten gebogen</li> <li>• Höhe 30 mm</li> <li>• mit <b>Skala</b> in der Mitte und an den Seiten</li> <li>• nur <b>248 g</b></li> <li>• auf Zoom Eurolochkarte</li> </ul> <p>mattschwarz</p> <p>silber</p>	<p><b>MTB RISE HANDLEBAR</b></p> <ul style="list-style-type: none"> <li>• <b>aluminium</b></li> <li>• <b>butted</b></li> <li>• 620 mm</li> <li>• bar center <b>Ø 25.4 mm</b></li> <li>• 10° backsweep</li> <li>• rise 30 mm</li> <li>• with <b>scale</b> in the middle and at the sides</li> <li>• only <b>248 g</b></li> <li>• on Zoom eurohole card</li> </ul> <p>matt black</p> <p>silver</p> <p>UVP 15,90 € UVP mAD 23,90 €</p>	<p>Tested by the manufacturer based on ISO 4210</p>
<p><b>403222</b> AD</p> <p><b>403223</b> AD 50</p>	<p><b>MTB RISE LENKER</b></p> <ul style="list-style-type: none"> <li>• <b>Aluminium</b></li> <li>• <b>konifiziert</b></li> <li>• 600 mm</li> <li>• Klemmung <b>Ø 25,4 mm</b></li> <li>• 15° nach hinten gebogen</li> <li>• Höhe 30 mm</li> <li>• mit <b>Skala</b> in der Mitte und an den Seiten</li> <li>• nur <b>229 g</b></li> <li>• Montageverpackung</li> </ul> <p>mattschwarz</p> <p>silber</p>	<p><b>MTB RISE HANDLEBAR</b></p> <ul style="list-style-type: none"> <li>• <b>aluminium</b></li> <li>• <b>butted</b></li> <li>• 600 mm</li> <li>• bar center <b>Ø 25.4 mm</b></li> <li>• 15° backsweep</li> <li>• rise 30 mm</li> <li>• with <b>scale</b> in the middle and at the sides</li> <li>• only <b>229 g</b></li> <li>• OEM</li> </ul> <p>matt black</p> <p>silver</p> <p>UVP 12,90 € UVP mAD 18,90 €</p>	

ART.-NR.	BESCHREIBUNG	DESCRIPTION	
	<b>TREKKING RISE LENKER</b> <b>HB-C2.1&lt;</b> <ul style="list-style-type: none"> <li>• Aluminium</li> <li>• mattschwarz</li> <li>• Klemmung Ø 31,8 mm</li> <li>• 640 mm</li> <li>• 38° nach hinten gebogen</li> <li>• 36° nach oben gebogen</li> </ul> <p>Höhe 38 mm</p>	<b>TREKKING RISE HANDLEBAR</b> <b>HB-C2.1&lt;</b> <ul style="list-style-type: none"> <li>• aluminium</li> <li>• matt black</li> <li>• bar center Ø 31.8 mm</li> <li>• 640 mm</li> <li>• 38° backsweep</li> <li>• 36° upsweep</li> </ul> <p>rise 38 mm</p>	<p>Tested by the manufacturer based on ISO 4210</p> <p><b>FRONT VIEW</b></p> <p><b>SIDE VIEW</b></p>
<b>403971</b>	Montageverpackung	OEM	
<b>403974</b>	auf M-Wave Eurolochkarte	on M-Wave eurohole card	
	Höhe 21 mm	rise 21 mm	
<b>403973</b>	Montageverpackung	OEM	
<b>403976</b>	auf M-Wave Eurolochkarte	on M-Wave eurohole card	UVP 19,90 €
	<ul style="list-style-type: none"> <li>• 660 mm</li> <li>• 18° nach hinten gebogen</li> <li>• 12° nach oben gebogen</li> <li>• Höhe 25 mm</li> </ul>	<ul style="list-style-type: none"> <li>• 660 mm</li> <li>• 18° backsweep</li> <li>• 12° upsweep</li> <li>• rise 25 mm</li> </ul>	
<b>403972</b>	Montageverpackung	OEM	UVP 19,90 €
<b>AD 50</b>			UVP mAD 28,90 €
<b>403975</b>	auf M-Wave Eurolochkarte	on M-Wave eurohole card	UVP 19,90 €
<b>30</b>			
	<b>TOURING / TREKKING RISE LENKER</b> <ul style="list-style-type: none"> <li>• Aluminium</li> <li>• 600 mm</li> <li>• Klemmung Ø 25,4 mm</li> <li>• 15° nach hinten gebogen</li> <li>• Höhe 30 mm</li> <li>• Montageverpackung</li> <li>• 30° nach oben gebogen</li> </ul>	<b>TOURING / TREKKING RISE HANDLEBAR</b> <ul style="list-style-type: none"> <li>• aluminium</li> <li>• 600 mm</li> <li>• bar center Ø 25.4 mm</li> <li>• 15° backsweep</li> <li>• rise 30 mm</li> <li>• OEM</li> <li>• 30° upsweep</li> </ul>	<p>Tested by the manufacturer based on ISO 4210</p>
• <b>401206</b>	schwarz	black	
<b>AD 50</b>			
• <b>401207</b>	silber	silver	UVP 9,90 €
<b>AD 50</b>			UVP mAD 14,90 €
• <b>401201</b>	<ul style="list-style-type: none"> <li>• Stahl</li> <li>• schwarz</li> <li>• 580 mm</li> <li>• 3° nach oben gebogen</li> </ul>	<ul style="list-style-type: none"> <li>• steel</li> <li>• black</li> <li>• 580 mm</li> <li>• 3° upsweep</li> </ul>	UVP 7,90 €
<b>AD 50</b>			UVP mAD 11,90 €
	<b>TOURING LENKER</b> <ul style="list-style-type: none"> <li>• Aluminium</li> <li>• 590 mm</li> <li>• Klemmung Ø 25,4 mm</li> <li>• 33° nach hinten gebogen</li> <li>• 16° nach oben gebogen</li> <li>• Höhe 26 mm</li> <li>• Montageverpackung</li> </ul>	<b>TOURING HANDLEBAR</b> <ul style="list-style-type: none"> <li>• aluminium</li> <li>• 590 mm</li> <li>• bar center Ø 25.4 mm</li> <li>• 33° backsweep</li> <li>• 16° upsweep</li> <li>• rise 26 mm</li> <li>• OEM</li> </ul>	<p>Tested by the manufacturer based on ISO 4210</p>
<b>401400</b>	mattschwarz	matt black	
<b>401401</b>	silber	silver	UVP 13,90 €
<b>50</b>			
• <b>401225</b>	<ul style="list-style-type: none"> <li>• Stahl</li> <li>• schwarz</li> <li>• 600 mm</li> <li>• 35° nach hinten gebogen</li> <li>• 41° nach oben gebogen</li> <li>• Höhe 60 mm</li> <li>• Ø 22,2 / 25,4 mm</li> <li>• Montageverpackung</li> </ul>	<ul style="list-style-type: none"> <li>• steel</li> <li>• black</li> <li>• 600 mm</li> <li>• 35° backsweep</li> <li>• 41° upsweep</li> <li>• rise 60 mm</li> <li>• Ø 22.2 / 25.4 mm</li> <li>• OEM</li> </ul>	UVP 8,90 €
<b>AD 20</b>			UVP mAD 12,90 €

ART.-NR.	BESCHREIBUNG	DESCRIPTION	
<b>401282</b> 25	<b>TREKKING LENKER</b> <ul style="list-style-type: none"> <li>• <b>Aluminium</b></li> <li>• <b>zusätzlicher Lenkerbogen</b> (Ø 22,2 mm) bietet <b>Platz</b> für Taschen, Lampen, Computer, Handys, innen montierte Lenker-zusatzgriffe, ...</li> <li>• Breite 660 mm</li> <li>• Klemmung Ø 31,8 mm</li> <li>• 45° nach hinten gebogen</li> <li>• Höhe 13 mm</li> <li>• Montageverpackung</li> </ul>	<b>TREKKING HANDLEBAR</b> <ul style="list-style-type: none"> <li>• <b>aluminium</b></li> <li>• <b>additional handlebar bow</b> (Ø 22.2 mm) offers <b>space</b> for bags, lamps, computers, mobile phones, inner bar ends, ...</li> <li>• width 660 mm</li> <li>• bar center Ø 31.8 mm</li> <li>• 45° backsweep</li> <li>• rise 13 mm</li> <li>• OEM</li> </ul>	Tested by the manufacturer based on ISO 4210  UVP 44,90 €
<b>403708</b> AD  <b>403709</b> AD 20	<b>MULTIPOSITIONSLENKER</b> <ul style="list-style-type: none"> <li>• <b>Aluminium</b></li> <li>• mit <b>3+ Griffpositionen</b></li> <li>• 590 mm</li> <li>• für Klemmung Ø 25,4 mm</li> <li>• Montageverpackung</li> </ul> <p>silber</p> <p>schwarz</p>	<b>MULTIPOSITION HANDLEBAR</b> <ul style="list-style-type: none"> <li>• <b>aluminium</b></li> <li>• with <b>3+ grip positions</b></li> <li>• 590 mm</li> <li>• bar center Ø 25.4 mm</li> <li>• OEM</li> </ul> <p>silver</p> <p>black</p>	Tested by the manufacturer based on ISO 4210  UVP 19,90 € UVP mAD 28,90 €
<b>403980</b> AD  <b>403981</b> AD 15	<b>GRAVEL LENKER</b> <ul style="list-style-type: none"> <li>• <b>konifiziertes</b> Aluminium</li> <li>• <b>Flare 25°</b></li> <li>• Reach 83 mm</li> <li>• <b>Drop nur 107 mm</b></li> <li>• Klemmung <b>Ø 31,8 mm</b></li> <li>• nur 349 g (400 mm)</li> <li>• mit <b>Skala</b> in der Mitte</li> <li>• Lenkerend-Ø 23,8 mm</li> <li>• mattschwarz eloxiert</li> <li>• auf Zoom Eurolochkarte</li> </ul> <p><b>A:</b> 400 mm (innen - innen) <b>B:</b> 520 mm (unten, Mitte - Mitte)</p> <p><b>A:</b> 440 mm (innen - innen) <b>B:</b> 560 mm (unten, Mitte - Mitte)</p>	<b>GRAVEL HANDLEBAR</b> <ul style="list-style-type: none"> <li>• <b>butted</b> aluminium</li> <li>• <b>flare 25°</b></li> <li>• reach 83 mm</li> <li>• <b>drop only 107 mm</b></li> <li>• bar center <b>Ø 31.8 mm</b></li> <li>• only 349 g (400 mm)</li> <li>• with <b>scale</b> in the middle</li> <li>• handlebar ends Ø 23.8 mm</li> <li>• matt black anodized</li> <li>• on Zoom eurohole card</li> </ul> <p><b>A:</b> 400 mm (inside - inside) <b>B:</b> 520 mm (below, center - center)</p> <p><b>A:</b> 440 mm (inside - inside) <b>B:</b> 560 mm (below, center - center)</p>	<b>GRAVEL</b> Tested by the manufacturer based on ISO 4210  UVP 31,90 € UVP mAD 45,90 €
<b>403927</b> AD  <b>403928</b> AD 20	<b>KOMPAKT RENNLENKER</b> <ul style="list-style-type: none"> <li>• <b>konifiziertes</b> Aluminium</li> <li>• <b>6° nach hinten gebogenes</b> Oberrohr ermöglicht <b>anatomisch entspannte Haltung</b></li> <li>• Reach 75 mm</li> <li>• <b>Drop nur 128 mm</b></li> <li>• Klemmung <b>Ø 31,8 mm</b></li> <li>• mit Nut für Schalt- und Bremskabel</li> <li>• nur <b>312 g</b> (425 mm)</li> <li>• mit <b>Skala</b></li> <li>• Lenkerend-Ø 23,8 mm</li> <li>• mattschwarz eloxiert</li> <li>• Montageverpackung</li> </ul> <p>420 mm (Mitte - Mitte) nur <b>289 g</b></p> <p>440 mm (Mitte - Mitte) nur <b>328 g</b></p>	<b>COMPACT RACING HANDLEBAR</b> <ul style="list-style-type: none"> <li>• <b>butted</b> aluminium</li> <li>• <b>6° backsweep</b> top tube enables <b>anatomically relaxed posture</b></li> <li>• reach 75 mm</li> <li>• <b>drop only 128 mm</b></li> <li>• bar center <b>Ø 31.8 mm</b></li> <li>• with shifting and brake cable routing</li> <li>• only <b>312 g</b> (425 mm)</li> <li>• with <b>scale</b></li> <li>• handlebar ends Ø 23.8 mm</li> <li>• matt black anodized</li> <li>• OEM</li> </ul> <p>420 mm (middle - middle) nur <b>289 g</b></p> <p>440 mm (middle - middle) nur <b>328 g</b></p>	Tested by the manufacturer based on ISO 4210  <b>312 g</b> UVP 29,90 € UVP mAD 43,90 €

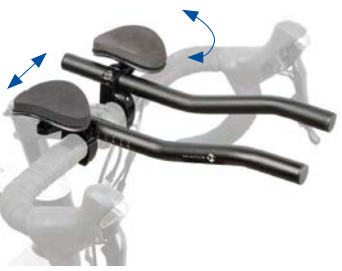



ART.-NR.	BESCHREIBUNG	DESCRIPTION	
<b>403739</b> 10	<b>TRIATHLON-AUFSATZ</b> <ul style="list-style-type: none"> <li>• <b>Aluminium</b></li> <li>• schwarz</li> <li>• für Lenker Ø 31,8 mm (mit Adapter für Ø 25,4 mm)</li> <li>• <b>Breite und Winkel der Armauflage verstellbar</b></li> <li>• Polster austauschbar</li> <li>• Ausleger mit <b>Skala</b></li> <li>• nur <b>437 g</b></li> <li>• auf Tranz X Eurolochkarte</li> </ul>	<b>TRI BAR</b> <ul style="list-style-type: none"> <li>• <b>aluminium</b></li> <li>• black</li> <li>• for handlebar Ø 31.8 mm (with adapter for Ø 25.4 mm)</li> <li>• <b>adjustable arm rest width and angle</b></li> <li>• pads replaceable</li> <li>• extension with <b>scale</b></li> <li>• only <b>437 g</b></li> <li>• on Tranz X eurohole card</li> </ul> <p style="text-align: right;">UVP 78,90 €</p>	 <p style="text-align: right;"><b>Tranz X</b> COMPONENTS</p>
<b>403750</b> 25	<b>TRIATHLON-AUFSATZ</b> <ul style="list-style-type: none"> <li>• <b>Aluminium</b></li> <li>• schwarz</li> <li>• für Lenker Ø 31,8 mm (mit Adapter für Ø 25,4 mm)</li> <li>• <b>Breite und Winkel der Armauflage verstellbar</b></li> <li>• Polster austauschbar</li> <li>• Ausleger mit <b>Skala</b></li> <li>• nur <b>448 g</b></li> <li>• auf M-Wave Eurolochkarte</li> </ul> <p>›AERO F‹</p>	<b>TRI BAR</b> <ul style="list-style-type: none"> <li>• <b>aluminium</b></li> <li>• black</li> <li>• for handlebar Ø 31.8 mm (with adapter for Ø 25.4 mm)</li> <li>• <b>adjustable arm rest width and angle</b></li> <li>• pads replaceable</li> <li>• extension with <b>scale</b></li> <li>• only <b>448 g</b></li> <li>• on M-Wave eurohole card</li> </ul> <p>›AERO F‹</p> <p style="text-align: right;">UVP 35,90 €</p>	 <p style="text-align: right;"><b>M-WAVE</b></p>
<b>403742</b> 25	<p>›AERO H‹</p>	<p>›AERO H‹</p> <p style="text-align: right;">UVP 35,90 €</p>	
<b>403699</b> 10	<b>TRIATHLON-AUFSATZ</b> <ul style="list-style-type: none"> <li>• <b>Aluminium</b></li> <li>• schwarz</li> <li>• für Lenker Ø 25,4 mm (mit Adapter für Ø 22,2 mm)</li> <li>• Breite der Armauflage verstellbar</li> <li>• Armauflage und Bügel gepolstert</li> <li>• mit Ventura Blisterverpackung</li> </ul>	<b>TRI BAR</b> <ul style="list-style-type: none"> <li>• <b>aluminium</b></li> <li>• black</li> <li>• for handlebar Ø 25.4 mm (with adapter for Ø 22.2 mm)</li> <li>• adjustable armrest width</li> <li>• padded armrest and bow</li> <li>• with Ventura blister packaging</li> </ul> <p style="text-align: right;">UVP 24,90 €</p>	 <p style="text-align: right;"><b>VENTURA</b> BIKE + OUTDOOR</p>
<b>400120</b> 200/50 set	<b>REDUZIERHÜLSEN-SET</b> <ul style="list-style-type: none"> <li>• reduziert die Lenkerklemmung von Vorbauten von <b>Ø 31,8 mm auf Ø 25,4 mm</b></li> <li>• Länge: <b>50 mm, für großflächige und schonende Klemmung</b></li> <li>• Aluminium</li> <li>• 1 Paar im Polybeutel mit Barcode-aufkleber</li> </ul>	<b>SHIM SET</b> <ul style="list-style-type: none"> <li>• reduces the handlebar clamp of stems from <b>Ø 31.8 mm to Ø 25.4 mm</b></li> <li>• length: <b>50 mm, for extensive and careful clamping</b></li> <li>• aluminium</li> <li>• 1 pair in PE bag with barcode sticker</li> </ul> <p style="text-align: right;">UVP 3,90 €</p>	



# HANDLE STEMS

# VERSTELLBARE LENKERVORBAUTEN ADJUSTABLE HANDLE STEMS

ROMAX



ART.-NR. 	BESCHREIBUNG	DESCRIPTION	
	<p><b>VERSTELLBARER LENKERVORBAU</b></p> <ul style="list-style-type: none"> <li>• <b>Schnellverstellung</b> von Winkel und Lenkerklemmung <b>ohne Werkzeug</b></li> <li>• <b>Aluminium</b></li> <li>• von <b>0°- 70° verstellbar</b></li> <li>• mit verstärktem Nylon-Schnellspanner</li> <li>• Länge 110 mm</li> <li>• für 1 1/8" (25,4 mm)</li> <li>• Schaftlänge 180 mm</li> <li>• schwarz</li> <li>• in Promax Eurolochbox</li> </ul>	<p><b>ADJUSTABLE HANDLE STEM</b></p> <ul style="list-style-type: none"> <li>• <b>quick adjusting</b> of angle and handlebar clamp <b>without tools</b></li> <li>• <b>aluminium</b></li> <li>• <b>adjustable</b> from <b>0°- 70°</b></li> <li>• with reinforced nylon QR</li> <li>• length 110 mm</li> <li>• for 1 1/8" (25.4 mm)</li> <li>• shaft length 180 mm</li> <li>• black</li> <li>• in Promax eurohole box</li> </ul>	<p>Tested by the manufacturer based on ISO 4210</p>    <p>open-close</p> <p>70°</p> <p>0°</p> 
400325	Lenkerklemmung <b>Ø 25,4 mm</b>	clamp <b>Ø 25.4 mm</b>	UVP 36,90 €
400326 20	Lenkerklemmung <b>Ø 31,8 mm</b>	clamp <b>Ø 31.8 mm</b>	UVP 40,90 €
	<p><b>VERSTELLBARER LENKERVORBAU</b></p> <ul style="list-style-type: none"> <li>• <b>Aluminium</b></li> <li>• mit <b>Nirosta-Schaftrohr</b></li> <li>• verstellbar von <b>0°- 50°</b></li> <li>• Länge <b>85 mm</b></li> <li>• Schaftlänge <b>300 mm</b></li> </ul> <ul style="list-style-type: none"> <li>• für <b>1" (22,2 mm)</b> und mit <b>Ausgleichshülse</b> für 1 1/8" (25,4 mm)</li> <li>• Lenkerklemmung <b>Ø 25,4 mm</b></li> </ul>	<p><b>ADJUSTABLE HANDLE STEM</b></p> <ul style="list-style-type: none"> <li>• <b>aluminium</b></li> <li>• with <b>stainless steel lower stem</b></li> <li>• adjustable from <b>0°- 50°</b></li> <li>• length <b>85 mm</b></li> <li>• shaft length <b>300 mm</b></li> </ul> <ul style="list-style-type: none"> <li>• for <b>1" (22.2 mm)</b> and with <b>spacer</b> for 1 1/8" (25.4 mm)</li> <li>• clamp <b>Ø 25.4 mm</b></li> </ul>	<p>Tested by the manufacturer based on ISO 4210</p>   <p>300 mm</p> <p>85 mm</p> <p><b>NIROSTA/STAINLESS</b></p>
400314	schwarz	black	
400308 30	silber	silver	UVP 26,90 €
400324 30	<ul style="list-style-type: none"> <li>• für <b>1 1/8" (25,4 mm)</b></li> <li>• Lenkerklemmung <b>Ø 31,8 mm</b></li> <li>• schwarz</li> </ul>	<ul style="list-style-type: none"> <li>• for <b>1 1/8" (25.4 mm)</b></li> <li>• clamp <b>Ø 31.8 mm</b></li> <li>• black</li> </ul>	UVP 28,90 €
	<p><b>VERSTELLBARER LENKERVORBAU</b> ›ST-C2.2‹</p> <ul style="list-style-type: none"> <li>• <b>Aluminium</b></li> <li>• schwarz</li> <li>• verstellbar von <b>0°- 90°</b></li> <li>• für 1 1/8" (25,4 mm)</li> <li>• Lenkerklemmung <b>Ø 31,8 mm</b></li> <li>• Schaftlänge 180 mm</li> </ul> <p>Länge <b>90 mm</b></p> <p>404014 auf M-Wave Karte</p> <p>404016 Montageverpackung</p> <p>Länge <b>110 mm</b></p> <p>404015 auf M-Wave Karte</p> <p>404017 Montageverpackung</p> <p>40</p>	<p><b>ADJUSTABLE HANDLE STEM</b> ›ST-C2.2‹</p> <ul style="list-style-type: none"> <li>• <b>aluminium</b></li> <li>• black</li> <li>• adjustable from <b>0°- 90°</b></li> <li>• for 1 1/8" (25.4 mm)</li> <li>• clamp <b>Ø 31.8 mm</b></li> <li>• shaft length 180 mm</li> </ul> <p>length <b>90 mm</b></p> <p>on M-Wave tag</p> <p>OEM</p> <p>length <b>110 mm</b></p> <p>on M-Wave tag</p> <p>OEM</p> <p>UVP 22,90 €</p>	<p>Tested by the manufacturer based on ISO 4210</p>   











ART.-NR.	BESCHREIBUNG	DESCRIPTION	
 <b>400211</b> <b>400212</b> 30	<b>VERSTELLBARER LENKERVORBAU</b> <ul style="list-style-type: none"> <li>mit <b>Aluminium</b>schaftrohr</li> <li>verstellbar von <b>0°- 50°</b></li> <li>Lenkerklemmung für Ø 25,4 mm</li> <li>für 1" (22,2 mm) und mit <b>Ausgleichshülse</b> für 1 1/8" (25,4 mm)</li> <li>Schaftlänge 180mm</li> </ul> Länge <b>85 mm</b> , schwarz Länge <b>105 mm</b> , silber	<b>ADJUSTABLE HANDLE STEM</b> <ul style="list-style-type: none"> <li>with <b>aluminium</b> lower stem</li> <li>adjustable from <b>0°- 50°</b></li> <li>clamp for Ø 25.4 mm</li> <li>for 1" (22.2 mm) and with <b>spacer</b> for 1 1/8" (25.4 mm)</li> <li>shaft length 180 mm</li> </ul> length <b>85 mm</b> , black length <b>105 mm</b> , silver UVP 19,90 €	
<b>400298</b> <b>400299</b> 25	Länge <b>110 mm</b> , silber für 1" (22,2 mm) für 1 1/8" (25,4 mm)	length <b>110 mm</b> , silver for 1" (22.2 mm) for 1 1/8" (25.4 mm) UVP 14,90 €	
<b>404027</b> <b>404029</b> 50	<b>LENKERVORBAU</b> <ul style="list-style-type: none"> <li>für 1" (22,2 mm)</li> <li>Lenkerklemmung für Ø 25,4 mm</li> <li>Länge <b>40 mm</b></li> <li>Schaftlänge <b>300 mm</b></li> <li>schwarzer <b>Aluminium</b>kopf</li> </ul> <b>Edelstahlschaft</b> verchromter Stahlschaft	<b>HANDLE STEM</b> <ul style="list-style-type: none"> <li>for 1" (22.2 mm)</li> <li>clamp for Ø 25.4 mm</li> <li>length <b>40 mm</b></li> <li>shaft length <b>300 mm</b></li> <li>black <b>aluminium</b> head</li> </ul> <b>stainless steel shaft</b> c. p. steel shaft UVP 12,90 € UVP 9,90 €	
<b>404056</b> 50	wie Art. 404029, aber mit <b>Ausgleichshülse</b> für 1 1/8"	like art. 404029, but with <b>spacer</b> for 1 1/8" UVP 11,90 €	
<b>404022</b> <b>404091</b> <b>404094</b> 50	für 1", Schaftlänge 270 mm, schwarzer Schaft für 1", Schaftlänge 160 mm, verchromter Schaft für 1 1/8", Schaftlänge 170 mm, verchromter Schaft	for 1", shaft length 270 mm, black shaft for 1", shaft length 160 mm, c. p. shaft for 1 1/8", shaft length 170 mm, c. p. shaft UVP 8,90 €	
<b>403432</b> <b>403430</b> 50	<b>LENKERVORBAU</b> <ul style="list-style-type: none"> <li>für 1" (22,2 mm)</li> <li>schwarz</li> <li>Lenkerklemmung für Ø 25,4 mm</li> <li>Stahl</li> <li>Schaftlänge 160 mm</li> <li>Montageverpackung</li> </ul> Länge 60 mm Länge 100 mm	<b>HANDLE STEM</b> <ul style="list-style-type: none"> <li>for 1" (22.2 mm)</li> <li>black</li> <li>clamp for Ø 25.4 mm</li> <li>steel</li> <li>shaft length 160 mm</li> <li>OEM</li> </ul> length 60 mm length 100 mm UVP 4,90 €	
<b>400230</b> <b>400234</b> 50	<b>LENKERVORBAU</b> <ul style="list-style-type: none"> <li>für 1" (22,2 mm)</li> <li><b>Aluminium</b></li> <li>- 17°</li> <li>Lenkerklemmung für Ø 25,4 mm</li> <li>Schaftlänge 150 mm</li> <li>silber poliert</li> </ul> Länge 80 mm Länge 100 mm	<b>HANDLE STEM</b> <ul style="list-style-type: none"> <li>for 1" (22.2 mm)</li> <li><b>aluminium</b></li> <li>- 17°</li> <li>clamp for Ø 25.4 mm</li> <li>shaft length 150 mm</li> <li>silver polished</li> </ul> length 80 mm length 100 mm UVP 11,90 €	

ART.-NR.	BESCHREIBUNG	DESCRIPTION	
<b>404151</b> 50	<b>LENKERVORBAU BMX</b> <ul style="list-style-type: none"> <li>Aluminiumkopf</li> <li>1" (22,2 mm)</li> <li>Länge 36 mm</li> <li>verchromter Stahlschaft 145 mm</li> <li>Vierfachklemme für Ø 22,2 mm</li> <li>Montageverpackung</li> </ul>	<b>HANDLE STEM BMX</b> <ul style="list-style-type: none"> <li>aluminium head</li> <li>1" (22.2 mm)</li> <li>length 36 mm</li> <li>c.p. steel shaft 145 mm</li> <li>4-bolt clamp for Ø 22.2 mm</li> <li>OEM</li> </ul>	  UVP 12,90 €
<b>404085</b> 100	<b>ADAPTER</b> <ul style="list-style-type: none"> <li>zur <b>Kombination</b> von 1 1/8" Ahead Vorbauten mit 1"-Gewindegabeln</li> <li>Aluminium</li> <li>Länge 150 mm</li> <li>schwarz</li> <li>Montageverpackung</li> </ul>	<b>ADAPTER</b> <ul style="list-style-type: none"> <li>for <b>combination</b> of 1 1/8" ahead stems with 1" forks with threads</li> <li>aluminium</li> <li>length 150 mm</li> <li>black</li> <li>OEM</li> </ul>	 1 1/8" AHEAD 1" STANDARD THREADED UVP 4,90 €
<b>404083</b> 250	<b>ADAPTER FÜR VORBAU</b> <ul style="list-style-type: none"> <li>Mit dieser Hülse kann ein 1" Vorbau in ein 1 1/8" Steuersatzrohr montiert werden!</li> <li>Aluminium</li> <li>90 mm hoch</li> <li>von 1 1/8" auf 1" (innen Ø 22,2 mm / außen Ø 25,4 mm)</li> <li>Montageverpackung</li> </ul>	<b>ADAPTER FOR STEM</b> <ul style="list-style-type: none"> <li>With this adapter you can assemble a 1" stem in a 1 1/8" head set tube!</li> <li>aluminium</li> <li>90 mm high</li> <li>from 1 1/8" to 1" (inner Ø 22.2 mm / outer Ø 25.4 mm)</li> <li>OEM</li> </ul>	 UVP 2,90 €
<b>400445</b> 30	<b>HÖHENADAPTER FÜR AHEAD VORBAU</b> <ul style="list-style-type: none"> <li>Aluminium</li> <li>für 1 1/8"</li> <li>Höhe <b>verstellbar</b> durch 3 bzw. 4 schmale und einen breiten Distanzring</li> <li>in Satori Blisterverpackung</li> </ul> <p><b>ohne Werkzeug</b> nach links und rechts um <b>90° drehbar</b></p>	<b>HEIGHT ADAPTER FOR AHEAD STEM</b> <ul style="list-style-type: none"> <li>aluminium</li> <li>for 1 1/8"</li> <li>height <b>adjustable</b> by 3 or 4 narrow and one wide spacer</li> <li>in Satori blister packaging</li> </ul> <p><b>90° turnable</b> to the left or right <b>without tools</b></p>	Tested by the manufacturer based on ISO 4210   90° UVP 41,90 €
<b>400441</b>  <b>400442</b> 30	schwarz  silber	black  silver	 65 mm  UVP 29,90 €
<b>400446</b> 100	<b>HÖHENADAPTER ›CP LIFT‹</b> <ul style="list-style-type: none"> <li>Aluminium</li> <li>für 1 1/8"</li> <li>Höhe <b>verstellbar</b> durch 1 x 5 mm und 3 x 10 mm Distanzringe</li> <li>inkl. Aheadkappe und Schraube</li> <li>in M-Wave Eurolochbox</li> </ul>	<b>HEIGHT ADAPTER ›CP LIFT‹</b> <ul style="list-style-type: none"> <li>aluminium</li> <li>for 1 1/8"</li> <li>height <b>adjustable</b> by 1 x 5 mm and 3 x 10 mm spacers</li> <li>incl. ahead cap and screw</li> <li>in M-Wave eurohole box</li> </ul>	Tested by the manufacturer based on ISO 4210 MTB   62 mm  UVP 19,90 €

ART.-NR.	BESCHREIBUNG	DESCRIPTION	
<p><b>404140</b> 20</p>	<p><b>HÖHENADAPTER FÜR AHEAD VORBAU ›EASY UP‹</b></p> <p>Ermöglicht die <b>Schnellhöhen</b>verstellung bei <b>Aheadvorbauten</b> in Sekunden – <b>ohne Werkzeug</b> durch Schnellspannhebel! "Easy up" wird unter den bereits vorhandenen Aheadvorbau eingebaut.</p> <ul style="list-style-type: none"> <li>• für 1 1/8" Aheadvorbauten und 1 1/8" Stahl- oder Aluminium-Gabelschäfte (mit Adapterhülsen)</li> <li>• <b>kein Spezialwerkzeug nötig</b></li> <li>• Verstellbereich bis <b>70 mm</b></li> <li>• mattschwarz</li> <li>• auf Satori Eurolochkarte</li> </ul>	<p><b>HEIGHT ADAPTER FOR AHEAD STEM ›EASY UP‹</b></p> <p><b>Height adjustment</b> for ahead stems within seconds – <b>without tools</b> by quick release lever! "Easy up" is installed below the already mounted ahead stem.</p> <ul style="list-style-type: none"> <li>• for 1 1/8" ahead stems and 1 1/8" steel or aluminium steerers (with adapter shims)</li> <li>• <b>no special tool necessary</b></li> <li>• adjustment range up to <b>70 mm</b></li> <li>• matt black</li> <li>• on Satori eurohole card</li> </ul> <p>UVP 63,90 €</p>	<p><b>SATORI</b></p>  <p>ADJUSTABLE</p> <p>up to 70 mm</p> 
<p><b>400315</b>  <b>400316</b> 30</p>	<p><b>VERSTELLBARER AHEAD LENKERVORBAU</b></p> <ul style="list-style-type: none"> <li>• <b>Schnellverstellung</b> von Winkel und Lenkerklemmung <b>ohne Werkzeug</b></li> <li>• <b>Aluminium</b></li> <li>• von <b>-10°- 90°</b> verstellbar</li> <li>• mit Schnellspanner</li> <li>• Länge 110 mm</li> <li>• 1 1/8" (28,6 mm)</li> <li>• auf Promax Eurolochkarte</li> </ul> <p>Lenkerklemmung für <b>Ø 25,4 mm</b></p> <p>Lenkerklemmung für <b>Ø 31,8 mm</b></p>	<p><b>ADJUSTABLE AHEAD HANDLE STEM</b></p> <ul style="list-style-type: none"> <li>• <b>quick adjusting</b> of angle and handlebar clamp <b>without tools</b></li> <li>• <b>aluminium</b></li> <li>• <b>adjustable</b> from <b>-10°- 90°</b></li> <li>• with QR</li> <li>• length 110 mm</li> <li>• 1 1/8" (28.6 mm)</li> <li>• on Promax eurohole card</li> </ul> <p>clamp for <b>Ø 25.4 mm</b></p> <p>clamp for <b>Ø 31.8 mm</b></p> <p>UVP 34,90 €</p> <p>UVP 39,90 €</p>	<p>Tested by the manufacturer based on ISO 4210</p> <p><b>ROMAX</b></p> <p>open-close</p> <p>90°</p> <p>-10°</p> 
<p><b>400305</b> 50</p>	<p><b>VERSTELLBARER AHEAD LENKERVORBAU</b></p> <ul style="list-style-type: none"> <li>• <b>Aluminium</b></li> <li>• von <b>-10°- 90°</b> verstellbar</li> <li>• Lenkerklemmung für Ø 31,8 mm</li> <li>• 1 1/8" (28,6 mm)</li> <li>• Länge <b>110 mm</b></li> <li>• mattschwarz</li> <li>• Montageverpackung</li> </ul>	<p><b>ADJUSTABLE AHEAD HANDLE STEM</b></p> <ul style="list-style-type: none"> <li>• <b>aluminium</b></li> <li>• <b>adjustable</b> from <b>-10°- 90°</b></li> <li>• clamp for Ø 31.8 mm</li> <li>• 1 1/8" (28.6 mm)</li> <li>• length <b>110 mm</b></li> <li>• matt black</li> <li>• OEM</li> </ul> <p>UVP 29,90 €</p>	<p>Tested by the manufacturer based on ISO 4210</p> <p><b>ROMAX</b></p> 
<p><b>400310</b> 50</p>	<p>ähnlich wie Art. 400305, aber</p> <ul style="list-style-type: none"> <li>• Länge <b>85 mm</b></li> <li>• eckige Form</li> </ul>	<p>similar to art. 400305, but</p> <ul style="list-style-type: none"> <li>• length <b>85 mm</b></li> <li>• angular shape</li> </ul> <p>UVP 22,90 €</p>	
<p><b>400319</b> <b>400320</b>  <b>400317</b> <b>400318</b> 50</p>	<p><b>VERSTELLBARER AHEAD LENKERVORBAU</b></p> <ul style="list-style-type: none"> <li>• getestet gemäß <b>DIN EN 15194</b> und zusätzlich nach dem höheren Standard der Klasse 2 bis <b>140 kg</b></li> <li>• <b>Aluminium</b></li> <li>• von <b>0°- 90°</b> verstellbar</li> <li>• Lenkerklemmung für Ø 31,8 mm</li> <li>• 1 1/8" (28,6 mm)</li> <li>• mattschwarz</li> </ul> <p><b>auf M-Wave Eurolochkarte</b></p> <p>90 mm</p> <p>110 mm</p> <p><b>Montageverpackung</b></p> <ul style="list-style-type: none"> <li>• <b>400317</b> 90 mm</li> <li>• <b>400318</b> 110 mm</li> </ul>	<p><b>ADJUSTABLE AHEAD HANDLE STEM</b></p> <ul style="list-style-type: none"> <li>• tested based on <b>DIN EN 15194</b> and also based on the higher standard of the class 2 up to <b>140 kg</b></li> <li>• <b>aluminium</b></li> <li>• <b>adjustable</b> from <b>0°- 90°</b></li> <li>• clamp for Ø 31.8 mm</li> <li>• 1 1/8" (28.6 mm)</li> <li>• matt black</li> </ul> <p><b>on M-Wave eurohole card</b></p> <p>90 mm</p> <p>110 mm</p> <p><b>OEM</b></p> <p>90 mm</p> <p>110 mm</p> <p>UVP 22,90 €</p>	<p>Tested by the manufacturer based on DIN EN 15194</p> <p><b>M-WAVE</b></p>  

ART.-NR.	BESCHREIBUNG	DESCRIPTION	
	<p><b>VERSTELLBARER AHEAD VORBAU</b></p> <ul style="list-style-type: none"> <li>• Aluminium, 3D geschmiedet</li> <li>• verstellbar von 0°- 60°</li> <li>• 1 1/8" (28,6 mm)</li> <li>• mattschwarz/silber</li> <li>• <b>267 g</b> (für 105/70 mm)</li> <li>• Montageverpackung</li> </ul> <p>2-tlg. Lenkerklemmung für <b>Ø 31,8 mm</b></p> <p><b>404160</b> Länge a = 105 mm/ b = 70 mm</p> <p><b>404162</b> Länge a = 125 mm/ b = 90 mm</p> <p>50</p>	<p><b>ADJUSTABLE AHEAD HANDLE STEM</b></p> <ul style="list-style-type: none"> <li>• aluminium, 3D forged</li> <li>• adjustable from 0°- 60°</li> <li>• 1 1/8" (28.6 mm)</li> <li>• matt black/silver</li> <li>• <b>267 g</b> (for 105/70 mm)</li> <li>• OEM</li> </ul> <p>two-part clamp for <b>Ø 31.8 mm</b></p> <p>length a = 105 mm/ b = 70 mm</p> <p>length a = 125 mm/ b = 90 mm</p> <p>UVP 25,90 €</p>	<p>Tested by the manufacturer based on ISO 4210</p>   
	<p>2-tlg. Lenkerklemmung für <b>Ø 25,4 mm</b></p> <p><b>404163</b> Länge a = 105 mm/ b = 70 mm</p> <p><b>404164</b> Länge a = 125 mm/ b = 90 mm</p> <p>50</p>	<p>two-part clamp for <b>Ø 25.4 mm</b></p> <p>length a = 105 mm/ b = 70 mm</p> <p>length a = 125 mm/ b = 90 mm</p> <p>UVP 24,90 €</p>	 <p>Ø 25,4 mm</p>
	<p><b>AHEAD LENKERVORBAU ›ST-C2.1‹</b></p> <ul style="list-style-type: none"> <li>• Aluminium, 3D geschmiedet</li> <li>• Lenkerklemmung für <b>Ø 35 mm</b></li> <li>• 1 1/8" (28,6 mm)</li> <li>• -12°</li> <li>• mattschwarz</li> <li>• auf M-Wave Eurolochkarte</li> </ul> <p><b>404320</b> 40 mm</p> <p><b>404322</b> 50 mm</p> <p>50</p>	<p><b>AHEAD HANDLE STEM ›ST-C2.1‹</b></p> <ul style="list-style-type: none"> <li>• aluminium, 3D forged</li> <li>• clamp for <b>Ø 35 mm</b></li> <li>• 1 1/8" (28.6 mm)</li> <li>• -12°</li> <li>• matt black</li> <li>• on M-Wave eurohole card</li> </ul> <p>40 mm</p> <p>50 mm</p> <p>UVP 28,90 €</p>	  <p>Ø 35 MM</p> 
	<p><b>AHEAD LENKERVORBAU ›ST-M4.1‹</b></p> <ul style="list-style-type: none"> <li>• Aluminium, 3D geschmiedet</li> <li>• 1 1/8" (28,6 mm)</li> <li>• 0°</li> <li>• Klemmhöhe: 43 mm</li> <li>• Lenkerklemmung für <b>Ø 31,8 mm</b></li> <li>• mattschwarz</li> </ul> <p><b>auf M-Wave Eurolochkarte</b></p> <p><b>400447</b> 35 mm</p> <p><b>400448</b> 50 mm</p> <p><b>Montageverpackung</b></p> <p><b>400449</b> 35 mm</p> <p><b>400450</b> 50 mm</p> <p>50</p>	<p><b>AHEAD HANDLE STEM ›ST-M4.1‹</b></p> <ul style="list-style-type: none"> <li>• aluminium, 3D forged</li> <li>• 1 1/8" (28.6 mm)</li> <li>• 0°</li> <li>• stack height: 43 mm</li> <li>• clamp for <b>Ø 31.8</b></li> <li>• matt black</li> </ul> <p><b>on M-Wave eurohole card</b></p> <p>35 mm</p> <p>50 mm</p> <p><b>OEM</b></p> <p>35 mm</p> <p>50 mm</p> <p>UVP 36,90 €</p>	<p>Tested by the manufacturer based on ISO 4210</p>   
	<p><b>404209 AHEAD LENKERVORBAU</b></p> <p>50</p> <ul style="list-style-type: none"> <li>• Aluminium</li> <li>• 1 1/8" (28,6 mm)</li> <li>• Länge 50 mm</li> <li>• 30°</li> <li>• Lenkerklemmung für <b>Ø 31,8 mm</b></li> <li>• mattschwarz</li> <li>• Montageverpackung</li> </ul>	<p><b>AHEAD HANDLE STEM</b></p> <ul style="list-style-type: none"> <li>• aluminium</li> <li>• 1 1/8" (28.6 mm)</li> <li>• length 50 mm</li> <li>• 30°</li> <li>• clamp for <b>Ø 31.8 mm</b></li> <li>• matt black</li> <li>• OEM</li> </ul> <p>UVP 19,90 €</p>	<p>Tested by the manufacturer based on ISO 4210</p>  



ART.-NR.	BESCHREIBUNG	DESCRIPTION	
  <b>400466</b> <b>400467</b> <small>25</small>  <b>400468</b> <b>400469</b> <small>50</small>	<b>AHEAD LENKERVORBAU ›ST-M4.2‹</b> <ul style="list-style-type: none"> <li>• Aluminium, 3D geschmiedet</li> <li>• 1½" (28,6 mm)</li> <li>• 0°</li> <li>• Klemmhöhe: 36 mm</li> <li>• Lenkerklemmung für <b>Ø 31,8 mm</b></li> <li>• mattschwarz</li> </ul> <b>auf M-Wave Eurolochkarte</b> <p>35 mm</p> <p>50 mm</p> <b>Montageverpackung</b> <p>35 mm</p> <p>50 mm</p>	<b>AHEAD HANDLE STEM ›ST-M4.2‹</b> <ul style="list-style-type: none"> <li>• aluminium, 3D forged</li> <li>• 1½" (28.6 mm)</li> <li>• 0°</li> <li>• stack height: 36 mm</li> <li>• clamp for <b>Ø 31.8 mm</b></li> <li>• matt black</li> </ul> <b>on M-Wave eurohole card</b> <p>35 mm</p> <p>50 mm</p> <b>OEM</b> <p>35 mm</p> <p>50 mm</p> <p style="text-align: right;">UVP 25,90 €</p>	<p>Tested by the manufacturer based on ISO 4210</p>   
<b>404520</b> <small>25</small> <b>404522</b> <small>40</small> <b>404524</b> <small>25</small> <b>404526</b> <small>25</small>  <b>404521</b> <b>404523</b> <b>404525</b> <b>404527</b> <small>50</small>	<b>AHEAD LENKERVORBAU ›ST-M3.1‹</b> <ul style="list-style-type: none"> <li>• Aluminium, 3D geschmiedet</li> <li>• 1½" (28,6 mm)</li> <li>• Lenkerklemmung für <b>Ø 31,8 mm</b></li> <li>• ab <b>113 g</b></li> <li>• mattschwarz</li> </ul> <b>7°</b> <b>auf M-Wave Eurolochkarte</b> <p>60 mm</p> <p>90 mm</p> <p>100 mm</p> <p>110 mm</p> <b>Montageverpackung</b> <p>60 mm</p> <p>90 mm</p> <p>100 mm</p> <p>110 mm</p>	<b>AHEAD HANDLE STEM ›ST-M3.1‹</b> <ul style="list-style-type: none"> <li>• aluminium, 3D forged</li> <li>• 1½" (28.6 mm)</li> <li>• clamp for <b>Ø 31.8 mm</b></li> <li>• from <b>113 g</b></li> <li>• matt black</li> </ul> <b>7°</b> <b>on M-Wave eurohole card</b> <p>60 mm</p> <p>90 mm</p> <p>100 mm</p> <p>110 mm</p> <b>OEM</b> <p>60 mm</p> <p>90 mm</p> <p>100 mm</p> <p>110 mm</p> <p style="text-align: right;">UVP 16,90 €</p>	<p>Tested by the manufacturer based on ISO 4210</p>   
<b>404351</b> <b>404353</b> <b>404355</b> <b>404357</b>  <b>404350</b> <b>404352</b> <b>404354</b> <b>404356</b> <small>50</small>	<b>›ST-M3.2‹ 35°</b> <b>auf M-Wave Eurolochkarte</b> <p>60 mm</p> <p>80 mm</p> <p>100 mm</p> <p>120 mm</p> <b>Montageverpackung</b> <p>60 mm</p> <p>80 mm</p> <p>100 mm</p> <p>120 mm</p>	<b>›ST-M3.2‹ 35°</b> <b>on M-Wave eurohole card</b> <p>60 mm</p> <p>80 mm</p> <p>100 mm</p> <p>120 mm</p> <b>OEM</b> <p>60 mm</p> <p>80 mm</p> <p>100 mm</p> <p>120 mm</p> <p style="text-align: right;">UVP 21,90 €</p>	 

# AHEAD LENKERVORBAU AHEAD HANDLE STEM

ART.-NR. 	BESCHREIBUNG	DESCRIPTION	
	<p><b>AHEAD LENKERVORBAU ›ASTEM 3D‹</b></p> <ul style="list-style-type: none"> <li>• Aluminium, <b>3D geschmiedet</b></li> <li>• 1½" (28,6 mm)</li> <li>• 7°</li> <li>• Lenkerklemmung für <b>Ø 31,8 mm</b></li> <li>• mit rostgeschützten Schrauben</li> <li>• mattschwarz</li> </ul> <p><b>auf M-Wave Eurolochkarte</b></p> <p><b>404376</b> 60 mm (nur <b>118,5 g</b>)</p> <p><b>404253</b> 90 mm</p> <p><b>404258</b> 100 mm</p> <p><b>404277</b> 110 mm 50</p> <p><b>Montageverpackung</b></p> <ul style="list-style-type: none"> <li>• <b>404208</b> 60 mm</li> <li>• <b>404283</b> 90 mm</li> <li>• <b>404284</b> 100 mm</li> <li>• <b>404285</b> 110 mm 50</li> </ul>	<p><b>AHEAD HANDLE STEM ›ASTEM 3D‹</b></p> <ul style="list-style-type: none"> <li>• aluminium, <b>3D forged</b></li> <li>• 1½" (28.6 mm)</li> <li>• 7°</li> <li>• clamp for <b>Ø 31.8 mm</b></li> <li>• with rust protected screws</li> <li>• matt black</li> </ul> <p><b>on M-Wave eurohole card</b></p> <p>60 mm (only <b>118.5 g</b>)</p> <p>90 mm</p> <p>100 mm</p> <p>110 mm</p> <p><b>OEM</b></p> <p>60 mm</p> <p>90 mm</p> <p>100 mm</p> <p>110 mm</p> <p>UVP 11,90 €</p>	<p>Tested by the manufacturer based on ISO 4210</p>      
	<p><b>AHEAD LENKERVORBAU ›ST-M3.3‹</b></p> <ul style="list-style-type: none"> <li>• Aluminium, <b>3D geschmiedet</b></li> <li>• 1½" (28,6 mm)</li> <li>• 7°</li> <li>• Lenkerklemmung für <b>Ø 25,4 mm</b></li> <li>• mattschwarz</li> </ul> <p><b>auf M-Wave Eurolochkarte</b></p> <p><b>404400</b> 60 mm</p> <p><b>404401</b> 90 mm</p> <p><b>404402</b> 105 mm 25</p> <p><b>Montageverpackung</b></p> <ul style="list-style-type: none"> <li>• <b>404403</b> 60 mm</li> <li>• <b>404404</b> 90 mm</li> <li>• <b>404405</b> 105 mm 50</li> </ul>	<p><b>AHEAD HANDLE STEM ›ST-M3.3‹</b></p> <ul style="list-style-type: none"> <li>• aluminium, <b>3D forged</b></li> <li>• 1½" (28.6 mm)</li> <li>• 7°</li> <li>• clamp for <b>Ø 25.4 mm</b></li> <li>• matt black</li> </ul> <p><b>on M-Wave eurohole card</b></p> <p>60 mm</p> <p>90 mm</p> <p>105 mm</p> <p><b>OEM</b></p> <p>60 mm</p> <p>90 mm</p> <p>105 mm</p> <p>UVP 17,90 €</p>	<p>Tested by the manufacturer based on ISO 4210</p>     

ART.-NR.	BESCHREIBUNG	DESCRIPTION	
<p></p> <p><b>404237</b></p> <p><b>404235</b></p> <p><b>404236</b></p> <p>50</p>	<p><b>AHEAD LENKERVORBAU</b></p> <ul style="list-style-type: none"> <li>• Aluminium</li> <li>• 1 1/8" (28,6 mm)</li> <li>• Lenkerklemmung für <b>Ø 25,4 mm</b></li> <li>• mattschwarz</li> <li>• Montageverpackung</li> </ul> <p>15°/ 60 mm</p> <p>40°/ 90 mm</p> <p>25°/ 110 mm</p>	<p><b>AHEAD HANDLE STEM</b></p> <ul style="list-style-type: none"> <li>• aluminium</li> <li>• 1 1/8" (28.6 mm)</li> <li>• clamp for <b>Ø 25.4 mm</b></li> <li>• matt black</li> <li>• OEM</li> </ul> <p>15°/ 60 mm</p> <p>40°/ 90 mm</p> <p>25°/ 110 mm</p> <p>UVP 11,90 €</p>	<p>Tested by the manufacturer based on ISO 4210</p> <p></p> 
<p><b>404150</b></p> <p>50</p>	<p><b>AHEAD LENKERVORBAU BMX</b></p> <ul style="list-style-type: none"> <li>• Aluminium</li> <li>• 1 1/8" (28,6 mm)</li> <li>• schwarz</li> <li>• Länge 50 mm und Höhe 30 mm</li> <li>• 0°</li> <li>• Vierfachklemme für Ø 22,2 mm</li> <li>• mit <b>rostgeschützten</b> Schrauben</li> <li>• Montageverpackung</li> </ul>	<p><b>AHEAD HANDLE STEM BMX</b></p> <ul style="list-style-type: none"> <li>• aluminium</li> <li>• 1 1/8" (28.6 mm)</li> <li>• black</li> <li>• length 50 mm and height 30 mm</li> <li>• 0°</li> <li>• 4-screw clamp for Ø 22.2 mm</li> <li>• with <b>rust protected</b> screws</li> <li>• OEM</li> </ul> <p>UVP 13,90 €</p>	<p>Tested by the manufacturer based on EN 16054</p> <p></p> 
<p><b>400276</b></p> <p>20</p>	<p><b>DOPPELKLEMM-ADAPTER</b></p> <ul style="list-style-type: none"> <li>• zwischen Vorbau und Lenker</li> <li>• Aluminium</li> <li>• schwarz</li> <li>• <b>360° drehbar</b></li> <li>• <b>Vorbaulänge</b> und <b>-höhe</b> um <b>+/- 45 mm stufenlos</b> veränderbar, <b>Sitzwinkel</b> dadurch auch entsprechend veränderbar</li> <li>• für Vorbauklemmung Ø 25,4 mm</li> <li>• auf Tranz X Eurolochkarte</li> </ul>	<p><b>TWINHOLDER</b></p> <ul style="list-style-type: none"> <li>• between handle stem and handlebar</li> <li>• aluminium</li> <li>• black</li> <li>• <b>360° turnable</b></li> <li>• <b>stem length</b> and <b>height</b> is <b>stepless</b> changeable by <b>+/- 45 mm</b>, for this the <b>seat angle</b> can also be changed accordingly</li> <li>• for clamp Ø 25.4 mm</li> <li>• on Tranz X eurohole card</li> </ul> <p>UVP 29,90 €</p>	<p></p>  <p></p>
<p><b>400206</b></p> <p>500</p>	<p><b>AUSGLEICHSHÜLSE FÜR AHEAD VORBAU</b></p> <ul style="list-style-type: none"> <li>• Reduzierhülse von 1 1/8" (28,6 mm) auf 1" (25,4 mm)</li> <li>• Aluminium</li> <li>• 40 mm hoch</li> </ul>	<p><b>SPACER FOR AHEAD/STEM</b></p> <ul style="list-style-type: none"> <li>• spacer to reduce 1 1/8" (28.6 mm) to 1" (25.4 mm)</li> <li>• aluminium</li> <li>• 40 mm high</li> </ul> <p>UVP 1,90 €</p>	

ART.-NR.	BESCHREIBUNG	DESCRIPTION	
<b>LENKERZUSATZGRIFF INNEN</b>		<b>INNER BAR END</b>	
<b>408060</b> 100 pair NICE PRICE	<b>LENKERZUSATZGRIFF ›BE ANATOM IN‹</b> <ul style="list-style-type: none"> <li>zur Befestigung innen am Lenker für aerodynamische Fahrposition</li> <li>anatomische Form</li> <li>einteilig</li> <li>Aluminium</li> <li>schwarz</li> <li>mit Klemmung für Ø 22,2 mm</li> <li>auf M-Wave Eurolochkarte</li> </ul>	<b>BAR END ›BE ANATOM IN‹</b> <ul style="list-style-type: none"> <li>for fixing at the innerside of the handlebar for aerodynamic driving position</li> <li>anatomic shape</li> <li>one-piece</li> <li>aluminium</li> <li>black</li> <li>with clamp for Ø 22.2 mm</li> <li>on M-Wave eurohole card</li> </ul>	<p>UVP 14,90 €</p>
<b>LENKERZUSATZGRIFFE AUSSEN</b>		<b>OUTER BAR ENDS</b>	
<b>408043</b> 25 pair	<b>LENKERZUSATZGRIFF</b> <ul style="list-style-type: none"> <li>Aluminium</li> <li>anatomische Form</li> <li>einteilig</li> <li>schwarz</li> <li>nur 138 g/Pair</li> <li>mit Außenklemmung für Ø 22,2 mm</li> <li>auf Zoom Eurolochkarte</li> </ul>	<b>BAR END</b> <ul style="list-style-type: none"> <li>aluminium</li> <li>anatomic shape</li> <li>one-piece</li> <li>black</li> <li>only 138 g/pair</li> <li>with outer clamp for Ø 22.2 mm</li> <li>on Zoom eurohole card</li> </ul>	<p>UVP 22,90 €</p>
<b>408144</b> 25 pair	<b>LENKERZUSATZGRIFF</b> <ul style="list-style-type: none"> <li>Aluminium</li> <li>Aero-Form</li> <li>anatomische Kappe für Daumen</li> <li>einteilig</li> <li>Closed End-Design</li> <li>mit Außenklemmung für Ø 22,2 mm</li> <li>auf Zoom Eurolochkarte</li> </ul>	<b>BAR END</b> <ul style="list-style-type: none"> <li>aluminium</li> <li>aero shape</li> <li>anatomic cap for thumbs</li> <li>one-piece</li> <li>closed end design</li> <li>with outer clamp for Ø 22.2 mm</li> <li>on Zoom eurohole card</li> </ul>	<p>UVP 11,90 €</p>
<b>408152</b> 80 pair	<b>LENKERZUSATZGRIFF</b> <ul style="list-style-type: none"> <li>Aluminium, 3D geschmiedet</li> <li>kurze Ausführung</li> <li>einteilig</li> <li>nur 140 g/Pair</li> <li>mit Außenklemmung für Ø 22,2 mm</li> <li>Montageverpackung</li> </ul>	<b>BAR END</b> <ul style="list-style-type: none"> <li>aluminium, 3D forged</li> <li>short type</li> <li>one-piece</li> <li>only 140 g/pair</li> <li>with outer clamp for Ø 22.2 mm</li> <li>OEM</li> </ul>	<p>UVP 11,90 €</p>



ART.-NR.	BESCHREIBUNG	DESCRIPTION	
<b>408231</b> 40/20 pair NICE PRICE	<b>LENKERZUSATZGRIFF ›BE TOOL‹</b> <ul style="list-style-type: none"> <li>Aluminium</li> <li>mattschwarz</li> <li>Werkzeugset im Inneren mit <b>15 Funktionen:</b>                4/5/6/8 mm Innensechskantschlüssel                T 25 Vielzahnschlüssel                14G/0,136" Speichenschlüssel                Kreuz-/Schlitzschraubendreher                8/9/10 mm Ring-/Maulschlüssel  <b>Kettennietdrücker</b>                2 Reifenheber</li> <li>in M-Wave Blisterverpackung</li> </ul>	<b>BAR END ›BE TOOL‹</b> <ul style="list-style-type: none"> <li>aluminium</li> <li>matt black</li> <li>tool set inside with <b>15 functions:</b>                4/5/6/8 mm allen keys                T 25 star screwdriver                14G/0.136" spoke wrench                Phillips/flat type screwdriver                8/9/10 mm round wrench  <b>chain riveting tool</b>                2 tire levers</li> <li>in M-Wave blister packaging</li> </ul>	according to ISO 4210   UVP 18,90 €
<b>408167</b> 100 pair	<b>LENKERZUSATZGRIFF ›BE ANATOM‹</b> <ul style="list-style-type: none"> <li>anatomische Form</li> <li>einteilig</li> <li>Aluminium</li> <li>schwarz</li> <li>mit Außenklemmung</li> <li>auf M-Wave Eurolochkarte</li> </ul>	<b>BAR END ›BE ANATOM‹</b> <ul style="list-style-type: none"> <li>anatomic shape</li> <li>one-piece</li> <li>aluminium</li> <li>black</li> <li>with outer clamp</li> <li>on M-Wave eurohole card</li> </ul>	  UVP 8,90 €
<b>408113</b> 100 pair	<b>LENKERZUSATZGRIFF ›M-WAVE‹</b> <ul style="list-style-type: none"> <li>gerade, kurze Ausführung</li> <li>Aluminium</li> <li>mit Außenklemmung</li> <li>anatomische Kappe</li> <li>mattschwarz</li> <li>Montageverpackung</li> </ul>	<b>BAR END ›M-WAVE‹</b> <ul style="list-style-type: none"> <li>straight, short type</li> <li>aluminium</li> <li>with outer clamp</li> <li>anatomic cap</li> <li>matt black</li> <li>OEM</li> </ul>	  UVP 6,90 €
<b>408141</b> 100 pair	<b>LENKERZUSATZGRIFF</b> <ul style="list-style-type: none"> <li>Aluminium</li> <li>Außenklemmung</li> <li>drehbar</li> <li>lange Ausführung</li> <li>schwarz</li> <li>Montageverpackung</li> </ul>	<b>BAR END</b> <ul style="list-style-type: none"> <li>aluminium</li> <li>outer clamp</li> <li>turnable</li> <li>long type</li> <li>black</li> <li>OEM</li> </ul>	 UVP 6,90 €
<b>408070</b> 50 pair	<b>LENKERZUSATZGRIFF</b> <ul style="list-style-type: none"> <li>Aluminium</li> <li>für Innenklemmung Ø 15 mm, mit Adapter für Ø 19 mm</li> <li>mit Ausgleichshülse</li> <li>schwarz</li> <li>Montageverpackung</li> </ul>	<b>BAR END</b> <ul style="list-style-type: none"> <li>aluminium</li> <li>for inner clamp Ø 15 mm, with adapter for Ø 19 mm</li> <li>with spacer</li> <li>black</li> <li>OEM</li> </ul>	 UVP 9,90 €



# GRIPS

ART.-NR.	BESCHREIBUNG	DESCRIPTION	
  <b>410362</b>  <b>410346</b> 50 pair  <b>410345</b> 50 pair	<b>ECHTLEDER-GRIFF ›RETRO‹</b>  <ul style="list-style-type: none"> <li>• <b>Echtleder</b> Griff, <b>handgenäht</b></li> <li>• mit <b>"High Density"</b>-Schaumeinlage</li> <li>• mit Lenkerendstopfen</li> <li>• 125 mm</li> <li>• auf Velo Eurolochkarte</li> </ul> schwarz  braun  braun, Echtlederoptik	<b>LEATHER GRIP ›RETRO‹</b>  <ul style="list-style-type: none"> <li>• <b>genuine leather</b> grip, <b>hand stitched</b></li> <li>• with <b>"High Density"</b> foam</li> <li>• with handlebar plugs</li> <li>• 125 mm</li> <li>• on Velo eurohole card</li> </ul> black  brown UVP 27,90 €  brown, genuine leather design UVP 14,90 €	   
<b>410313</b> 50 pair	<b>ECHTLEDER-SCHRAUBGRIFF ›RETRO ERGO‹</b>  <ul style="list-style-type: none"> <li>• <b>Echtleder</b>-Griff, <b>handgenäht</b></li> <li>• <b>Zweikomponenten-Schraubgriff</b>: harter Kunststoff innen und weiche <b>Gel</b>-Mischung in der Mitte für <b>Komfort</b> und <b>Stoßabsorbierung</b></li> <li>• <b>Echtleder-Überzug</b> für optimalen und angenehmen <b>Grip</b></li> <li>• Kunststoffbasis mit <b>festintegrierter Schraubbefestigung</b> für <b>leichte (De-) Montage</b> und festen Halt am Lenker</li> <li>• Komfortgriff mit <b>ergonomischer Form</b>, die dem Abknicken der Handgelenke vorbeugt</li> <li>• mit geschlossenem Ende</li> <li>• 135 mm</li> <li>• auf Velo Eurolochkarte</li> </ul>	<b>LEATHER SCREW-ON GRIP ›RETRO ERGO‹</b>  <ul style="list-style-type: none"> <li>• <b>genuine leather</b> grip, <b>hand stitched</b></li> <li>• <b>2-Component screw-on grip</b>: hard inner mixture and soft <b>gel</b> mixture in the middle for <b>comfort</b> and <b>shock absorption</b></li> <li>• <b>genuine leather cover</b> for optimal and pleasant <b>grip</b></li> <li>• plastic base with <b>firmly integrated screw attachment</b> for <b>easy (dis-) assembly</b> and perfect grip at the handlebar</li> <li>• comfort grip with <b>ergonomic shape</b>, which prevents the wrists from deviating</li> <li>• with closed end</li> <li>• 135 mm</li> <li>• on Velo eurohole card</li> </ul> UVP 36,90 €	   
<b>410160</b> 50 pair	<b>SCHAUMSTOFF-SCHRAUBGRIFF ›ERGO EVA D3‹</b>  <ul style="list-style-type: none"> <li>• <b>Dreikomponenten-Schraubgriff</b>: harter Kunststoff innen, weiche Gummimischung in der Mitte für <b>Komfort</b> und <b>Stoßabsorbierung</b> und <b>weiche EVA soft-grip Oberfläche</b> außen</li> <li>• Kunststoffbasis mit <b>Aluminium Schraubbefestigung</b> für <b>leichte (De-) Montage</b> und festen Halt am Lenker</li> <li>• Komfortgriff mit <b>ergonomischer Form</b>, die dem Abknicken der Handgelenke vorbeugt</li> <li>• nur 85 g/Paar</li> <li>• mit Lenkerendstopfen</li> <li>• 131 mm</li> <li>• auf Velo Eurolochkarte</li> </ul>	<b>FOAM SCREW-ON GRIP ›ERGO EVA D3‹</b>  <ul style="list-style-type: none"> <li>• <b>3-Component screw-on grip</b>: hard inner mixture, soft rubber mixture in the middle for <b>comfort</b> and <b>shock absorbing</b> and <b>light EVA soft-grip surface</b> at the outside</li> <li>• plastic base with <b>aluminium screw attachment</b> for <b>easy (dis-) assembly</b> and perfect grip at the handlebar</li> <li>• comfort grip with <b>ergonomic shape</b>, which prevents the wrists from deviating</li> <li>• only 85 g/pair</li> <li>• with handlebar plugs</li> <li>• 131 mm</li> <li>• on Velo eurohole card</li> </ul> UVP 26,90 €	    
<b>410351</b> 50 pair	<b>SCHAUMSTOFF-SCHRAUBGRIFF ›LIGHT D3‹</b>  <ul style="list-style-type: none"> <li>• <b>Dreikomponenten-Schraubgriff</b>: harter Kunststoff und weiche Kunststoffmischung innen und zusätzliche Schaumstoffauflage außen für <b>Komfort</b> und <b>Stoßabsorbierung</b></li> <li>• Kunststoffbasis mit <b>doppelter Aluminium-Schraubbefestigung</b> für <b>leichte (De-)Montage</b> und <b>festen Halt</b> am Lenker</li> <li>• nur <b>76 g/</b>Paar</li> <li>• mit Lenkerendstopfen</li> <li>• 130 mm</li> <li>• in Velo Eurolochbox</li> </ul>	<b>FOAM SCREW-ON GRIP ›LIGHT D3‹</b>  <ul style="list-style-type: none"> <li>• <b>3-Component screw-on grip</b>: hard plastic and soft inner mixture and additional foam outer mixture for <b>comfort</b> and <b>shock absorbing</b></li> <li>• plastic base with <b>double aluminium screw attachment</b> for <b>easy (dis-) assembly</b> and <b>perfect grip</b> at the handlebar</li> <li>• only <b>76 g/</b>pair</li> <li>• with handlebar plugs</li> <li>• 130 mm</li> <li>• in Velo eurohole box</li> </ul> UVP 21,90 €	     













ART.-NR.	BESCHREIBUNG	DESCRIPTION	
<p></p> <p><b>410366</b> <b>410350</b> 50 pair</p>	<p><b>SCHRAUBGRIFF ›D3 ALUMINIUM‹</b></p> <ul style="list-style-type: none"> <li>• <b>Dreikomponenten-Schraubgriff:</b> harter Kunststoff innen und 2 weiche Mischungen außen für <b>Komfort</b> und <b>Stoßabsorbierung</b></li> <li>• Kunststoffbasis mit <b>doppelter Aluminium-Schraubbefestigung</b> für <b>leichte (De-)Montage</b> und <b>festen Halt</b> am Lenker</li> <li>• mit Lenkerendstopfen</li> <li>• 130 mm</li> <li>• in Velo Eurolochbox</li> </ul> <p>schwarz / weiß schwarz / grau</p>	<p><b>SCREW-ON GRIP ›D3 ALUMINIUM‹</b></p> <ul style="list-style-type: none"> <li>• <b>3-Component screw-on grip:</b> hard inner mixture and 2 soft outer mixtures for <b>comfort</b> and <b>shock absorbing</b></li> <li>• plastic base with <b>double aluminium screw attachment</b> for <b>easy (dis-)assembly</b> and <b>perfect grip</b> at the handlebar</li> <li>• with handlebar plugs</li> <li>• 130 mm</li> <li>• in Velo eurohole box</li> </ul> <p>black / white black / grey</p> <p>UVP 19,90 €</p>	 <p>FIX</p> <p>ALUMINIUM</p> <p>Triple D3 Density</p>
<p><b>410102</b> 50 pair</p>	<p><b>SCHRAUBGRIFF ›MUSHROOM D2‹</b></p> <ul style="list-style-type: none"> <li>• <b>Mushroom-Design</b></li> <li>• die nach außen <b>leicht konisch verlaufende Form</b> und die <b>spezielle Oberflächenstruktur</b> wirken dem <b>Abrutschen entgegen</b></li> <li>• <b>fließender Übergang zur Klemme</b></li> <li>• <b>Zweikomponenten-Schraubgriff:</b> harter Kunststoff innen und weiche Mischung außen für <b>Komfort</b> und <b>Stoßabsorbierung</b></li> <li>• Kunststoffbasis mit <b>Schraubbefestigung</b> für <b>leichte (De-)Montage</b> und <b>festen Halt</b> am Lenker</li> <li>• mit geschlossenem Ende</li> <li>• 135 mm</li> <li>• auf Velo Eurolochkarte</li> </ul>	<p><b>SCREW-ON GRIP ›MUSHROOM D2‹</b></p> <ul style="list-style-type: none"> <li>• <b>Mushroom-Design</b></li> <li>• <b>slightly conical shape</b> to the outside and the <b>special surface structure</b> counteract slipping</li> <li>• <b>smooth transition to the clamp</b></li> <li>• <b>2-Component screw-on grip:</b> hard inner mixture and soft outer mixture for <b>comfort</b> and <b>shock absorbing</b></li> <li>• plastic base with <b>screw attachment</b> for <b>easy (dis-)assembly</b> and <b>perfect grip</b> at the handlebar</li> <li>• with closed end</li> <li>• 135 mm</li> <li>• on Velo eurohole card</li> </ul> <p>UVP 12,90 €</p>	 <p>CONICAL SHAPE</p> <p>Double D2 Density</p> <p>29,5 mm</p> <p>32,5 mm</p> <p>FIX</p> <p>GRIP!</p>
<p><b>410101</b> 50 pair</p>	<p><b>SCHRAUBGRIFF ›MTB D2‹</b></p> <ul style="list-style-type: none"> <li>• die nach außen <b>leicht konisch verlaufende Form</b> und die <b>spezielle Oberflächenstruktur</b> wirken dem <b>Abrutschen entgegen</b></li> <li>• nach innen <b>fließender Übergang zur Klemme</b></li> <li>• <b>Zweikomponenten-Schraubgriff:</b> harter Kunststoff innen und weiche Mischung außen für <b>Komfort</b> und <b>Stoßabsorbierung</b></li> <li>• Kunststoffbasis mit <b>Schraubbefestigung</b> für <b>leichte (De-)Montage</b> und <b>festen Halt</b> am Lenker</li> <li>• 135 mm</li> <li>• auf Velo Eurolochkarte</li> </ul>	<p><b>SCREW-ON GRIP ›MTB D2‹</b></p> <ul style="list-style-type: none"> <li>• <b>slightly conical shape</b> to the outside and the <b>special surface structure</b> counteract slipping</li> <li>• <b>smooth transition to the clamp</b> on the inside</li> <li>• <b>tapered out form</b> reacts slipping off</li> <li>• <b>2-Component screw-on grip:</b> hard inner mixture and soft outer mixture for <b>comfort</b> and <b>shock absorbing</b></li> <li>• plastic base with <b>screw attachment</b> for <b>easy (dis-)assembly</b> and <b>perfect grip</b> at the handlebar</li> <li>• 135 mm</li> <li>• on Velo eurohole card</li> </ul> <p>UVP 13,90 €</p>	 <p>CONICAL SHAPE</p> <p>Double D2 Density</p> <p>28,5 mm</p> <p>32,1 mm</p> <p>FIX</p> <p>GRIP!</p>
<p><b>410461</b> 30 pair</p> <p><b>410466</b></p> <p><b>410467</b> 50 pair</p>	<p><b>SCHRAUBGRIFF ›ERGOGEL D3 BAR‹</b></p> <ul style="list-style-type: none"> <li>• ergonomische Form</li> <li>• <b>Dreikomponenten-Gel-Schraubgriff:</b> harter Kunststoff innen und 2 weiche Mischungen außen für <b>Komfort</b> und <b>Stoßabsorbierung</b></li> <li>• Kunststoffbasis mit <b>Schraubbefestigung</b> für <b>leichte (De-)Montage</b> und <b>festen Halt</b> am Lenker</li> <li>• <b>Verkaufshilfe</b> durch schwenkbare Velo Eurolochkarte</li> </ul> <p>›Long‹ 138 mm mit Lenkerendstopfen ›Long‹ 140 mm ›Long/Short‹ 140/92 mm</p>	<p><b>SCREW-ON GRIP ›ERGOGEL D3 BAR‹</b></p> <ul style="list-style-type: none"> <li>• ergonomic shape</li> <li>• <b>3-Component Gel screw-on grip:</b> hard inner mixture and 2 soft outer mixtures for <b>comfort</b> and <b>shock absorbing</b></li> <li>• plastic base with <b>screw attachment</b> for <b>easy (dis-)assembly</b> and <b>perfect grip</b> at the handlebar</li> <li>• <b>sales support</b> by rotatable Velo eurohole card</li> </ul> <p>›Long‹ 138 mm with handlebar plugs ›Long‹ 140 mm ›Long/Short‹ 140/92 mm</p> <p>UVP 29,90 € UVP 23,90 € UVP 23,90 €</p>	 <p>Triple D3 Density</p> <p>FIX</p> <p>FIX</p> <p>138 mm</p> <p>110 mm</p> <p>92 mm</p>

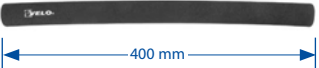

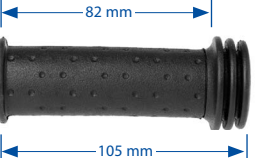
ART.-NR.	BESCHREIBUNG	DESCRIPTION	
<p></p> <p><b>SCHRAUBGRIFF ›ERGOGEL D3‹</b></p> <ul style="list-style-type: none"> <li>• Komfortgriff mit <b>ergonomischer Form</b>, die dem <b>Abknicken der Handgelenke</b> vorbeugt</li> <li>• <b>Dreikomponenten-Gel-Schraubgriff</b>: harter Kunststoff innen und 2 weiche Mischungen außen für <b>Komfort</b> und <b>Stoßabsorbierung</b></li> <li>• <b>leichte (De-) Montage</b> und <b>fester Halt</b> am Lenker durch <b>Schraubbefestigung</b></li> <li>• mit Lenkerendstopfen</li> <li>• in Velo Eurolochbox</li> </ul> <p><b>410450</b> 135 mm</p> <p><b>410451</b> 135 mm + 92 mm 50 pair</p>	<p><b>SCREW-ON GRIP ›ERGOGEL D3‹</b></p> <ul style="list-style-type: none"> <li>• comfort grip with <b>ergonomic shape</b>, which prevents the wrists from <b>deviating</b></li> <li>• <b>3-Component Gel screw-on grip</b>: hard inner mixture and 2 soft outer mixtures for <b>comfort</b> and <b>shock absorbing</b></li> <li>• <b>easy (dis-) assembly</b> and <b>perfect grip</b> at the handlebar through <b>screw attachment</b></li> <li>• with handlebar plugs</li> <li>• in Velo eurohole box</li> </ul> <p>135 mm</p> <p>135 mm + 92 mm</p> <p>UVP 16,90 €</p>	 <p>Triple D3 Density</p> <p>FIX</p> <p>135 mm   135 mm</p> <p>135 mm   92 mm</p> <p></p>	
<p><b>410374</b> 50 pair</p>	<p><b>GRIF ›ERGOGEL D3‹</b></p> <ul style="list-style-type: none"> <li>• Komfortgriff mit <b>ergonomischer Form</b>, die dem <b>Abknicken der Handgelenke</b> vorbeugt</li> <li>• <b>Dreikomponentengriff</b>: harte Mischung innen für <b>guten Halt</b> auf dem Lenker und 2 weiche Gel-Mischungen außen für <b>Komfort</b> und <b>Stoßabsorbierung</b></li> <li>• weiche Noppen geben <b>zusätzlich</b> bei Nässe einen <b>zuverlässigen Halt</b></li> <li>• mit Lenkerendstopfen</li> <li>• 130 mm</li> <li>• in Velo Eurolochbox</li> </ul>	<p><b>GRIP ›ERGOGEL D3‹</b></p> <ul style="list-style-type: none"> <li>• comfort grip with <b>ergonomic shape</b>, which prevents the wrists from <b>deviating</b></li> <li>• <b>3-component grip</b>: hard inner mixture for <b>good connection</b> with handlebar and 2 soft outer gel mixtures for <b>comfort</b> and <b>shock absorbing</b></li> <li>• soft knobs <b>avoid additionally slipping</b> especially at wet conditions</li> <li>• with handlebar plugs</li> <li>• 130 mm</li> <li>• in Velo eurohole box</li> </ul> <p>UVP 9,90 €</p>	 <p>Triple D3 Density</p> <p></p>
<p><b>410376</b> 135 mm</p> <p><b>410377</b> 135 mm + 92 mm 50 pair</p>	<p><b>GRIF ›ERGOGEL D2‹</b></p> <ul style="list-style-type: none"> <li>• Komfortgriff mit <b>ergonomischer Form</b>, die dem <b>Abknicken der Handgelenke</b> vorbeugt</li> <li>• <b>Zweikomponentengriff</b>: harte Mischung für <b>guten Halt</b> auf dem Lenker und weiche Mischung außen für <b>Komfort</b> und <b>Stoßabsorbierung</b></li> <li>• Negativprofil gibt <b>außerdem</b> bei Nässe einen <b>zuverlässigen Halt</b></li> <li>• mit Lenkerendstopfen</li> <li>• auf Velo Eurolochkarte</li> </ul>	<p><b>GRIP ›ERGOGEL D2‹</b></p> <ul style="list-style-type: none"> <li>• comfort grip with <b>ergonomic shape</b>, which prevents the wrists from <b>deviating</b></li> <li>• <b>2-component grip</b>: hard mixture for <b>good connection</b> with handlebar and soft outer mixture for <b>comfort</b> and <b>shock absorbing</b></li> <li>• negativ profil <b>avoids additionally slipping</b> especially at wet conditions</li> <li>• with handlebar plugs</li> <li>• on Velo eurohole card</li> </ul> <p>UVP 7,90 €</p>	 <p>Double D2 Density</p> <p>135 mm   135 mm</p> <p>135 mm   92 mm</p> <p></p>

ART.-NR. 	BESCHREIBUNG	DESCRIPTION	
<p><b>410369</b></p> <p><b>410360</b></p> <p><b>410361</b></p> <p><b>410363</b></p> <p>100 pair</p>	<p><b>GRIFF ›D2‹</b></p> <ul style="list-style-type: none"> <li>• <b>Zweikomponentengriff:</b> harte Mischung innen für <b>guten Halt</b> auf dem Lenker und weiche <b>D2</b> Mischung außen für <b>Komfort, Stoßabsorbierung und zuverlässigen Halt</b></li> <li>• 130 mm</li> <li>• auf Velo Eurolockkarte</li> </ul> <p>schwarz/weiß</p> <p>schwarz/grau</p> <p>schwarz/rot</p> <p>schwarz/blau</p>	<p><b>GRIP ›D2‹</b></p> <ul style="list-style-type: none"> <li>• <b>2-Component grip:</b> hard inner mixture for <b>good connection</b> with handlebar and soft outer <b>D2</b> mixture for <b>comfort, shock absorbing and perfect grip</b></li> <li>• 130 mm</li> <li>• on Velo eurohole card</li> </ul> <p>black/white</p> <p>black/grey</p> <p>black/red</p> <p>black/blue</p> <p>UVP 7,90 €</p>	<p>Double <b>D2</b> Density</p>   
<p><b>410370</b></p> <p>50 pair</p>	<p><b>GRIFF ›D2 NOPPEN‹</b></p> <ul style="list-style-type: none"> <li>• <b>Zweikomponentengriff:</b> harte Mischung innen für <b>guten Halt</b> auf dem Lenker und weiche <b>D2</b> Mischung außen für <b>Komfort und Stoßabsorbierung</b></li> <li>• weiche Noppen geben <b>zusätzlich</b> bei Nässe <b>zuverlässigen Halt</b></li> <li>• 130 mm</li> <li>• schwarz/grau</li> <li>• auf Velo Eurolockkarte</li> </ul>	<p><b>GRIP ›D2 KNOBS‹</b></p> <ul style="list-style-type: none"> <li>• <b>2-Component grip:</b> hard inner mixture for <b>good connection</b> with handlebar and soft outer <b>D2</b> mixture for <b>comfort and shock absorbing</b></li> <li>• soft knobs <b>avoid additionally slipping</b> especially at wet conditions</li> <li>• 130 mm</li> <li>• black/grey</li> <li>• on Velo eurohole card</li> </ul> <p>UVP 7,90 €</p>	<p>Double <b>D2</b> Density</p>  
<p><b>411210</b></p> <p>50 pair</p>	<p><b>GRIFF ›BMX‹</b></p> <ul style="list-style-type: none"> <li>• extra <b>breiter</b> und <b>griffiger</b> BMX-Griff</li> <li>• 135 mm</li> <li>• <b>Abrutschsicherung</b> innen</li> <li>• geschlossenes Ende</li> <li>• schwarz</li> <li>• auf Velo Eurolockkarte</li> </ul>	<p><b>GRIP ›BMX‹</b></p> <ul style="list-style-type: none"> <li>• extra <b>wide</b> and <b>handy</b> BMX grip</li> <li>• 135 mm</li> <li>• <b>slipping protection</b> at the inner end</li> <li>• closed end</li> <li>• black</li> <li>• on Velo eurohole card</li> </ul> <p>UVP 7,90 €</p>	 
<p><b>410340</b></p> <p>50 pair</p>	<p><b>GRIFF ›DURACORK‹</b></p> <ul style="list-style-type: none"> <li>• aus „<b>Duracork</b>“ (<b>Kork</b> und Kraton): natürliches Aussehen, aber <b>haltbarer</b> als purer Naturkork</li> <li>• braun</li> <li>• 130 mm</li> <li>• auf Velo Eurolockkarte</li> </ul>	<p><b>GRIP ›DURACORK‹</b></p> <ul style="list-style-type: none"> <li>• made of „<b>Duracork</b>“ (<b>cork</b> and craton): natural look with <b>higher durability</b> than pure cork</li> <li>• brown</li> <li>• 130 mm</li> <li>• on Velo eurohole card</li> </ul> <p>UVP 10,90 €</p>	 
<p><b>410365</b></p> <p>100 pair</p>	<p><b>GRIFF ›KORK‹</b></p> <ul style="list-style-type: none"> <li>• aus <b>Kork</b> / „<b>High Density</b>“-Schaum</li> <li>• schwarz / braun</li> <li>• 125 mm</li> <li>• auf Velo Eurolockkarte</li> </ul>	<p><b>GRIP ›CORK‹</b></p> <ul style="list-style-type: none"> <li>• made of <b>cork</b> / „<b>High Density</b>“ foam</li> <li>• black / brown</li> <li>• 125 mm</li> <li>• on Velo eurohole card</li> </ul> <p>UVP 6,90 €</p>	 
<p><b>410315</b></p> <p>50 pair</p>	<p><b>GRIFF ›WOOD‹</b></p> <ul style="list-style-type: none"> <li>• aus <b>superleichtem</b> EVA Schaum</li> <li>• nur <b>24 g</b>/Paar</li> <li>• <b>Holzoptik</b></li> <li>• 127 mm</li> <li>• geschlossenes Ende</li> <li>• auf Velo Eurolockkarte</li> </ul>	<p><b>GRIP ›WOOD‹</b></p> <ul style="list-style-type: none"> <li>• made of <b>super light</b> EVA foam</li> <li>• only <b>24 g</b>/pair</li> <li>• <b>wooden look</b></li> <li>• 127 mm</li> <li>• closed end</li> <li>• on Velo eurohole card</li> </ul> <p>UVP 10,90 €</p>	<p> <b>24 g</b> (pair)</p>  

ART.-NR.	BESCHREIBUNG	DESCRIPTION	
<b>410311</b> 100 pair	<b>GRIFF ›SCHAUM‹</b> <ul style="list-style-type: none"> <li>aus sehr hochwertigem <b>"High Density"</b>-Schaum</li> <li>nur <b>35 g/</b>Paar</li> <li>mit Lenkerendstopfen</li> <li>125 mm</li> <li>auf Velo Eurolochkarte</li> </ul>	<b>GRIP ›FOAM‹</b> <ul style="list-style-type: none"> <li>made of <b>"High Density"</b> foam</li> <li>only <b>35 g/</b>pair</li> <li>with handlebar plugs</li> <li>125 mm</li> <li>on Velo eurohole card</li> </ul>	  
<b>410392</b> 100 pair	<b>LENKERHÜLLE</b> <ul style="list-style-type: none"> <li>400 mm Schlauch</li> <li>aus sehr hochwertigem <b>"High Density"</b>-Schaum</li> <li>mit Lenkerendstopfen</li> <li>paarweise im Polybeutel mit Velo Eurolochheader</li> </ul>	<b>HANDLEBAR COVER</b> <ul style="list-style-type: none"> <li>400 mm tube</li> <li>made of <b>"High Density"</b> foam</li> <li>with handlebar plugs</li> <li>1 pair in PE bag with Velo eurohole header</li> </ul>	  
<b>410015</b> 100 pair	<b>KINDER- / JUGENDGRIFF</b> <ul style="list-style-type: none"> <li>mit <b>Sicherheitsende</b></li> <li>geschlossenes Ende</li> <li>schwarz</li> <li>105 mm</li> <li>auf Velo Eurolochkarte</li> </ul>	<b>CHILDREN / JUVENILE GRIP</b> <ul style="list-style-type: none"> <li>with <b>protection end</b></li> <li>closed end</li> <li>black</li> <li>105 mm</li> <li>on Velo eurohole card</li> </ul>	    

## LENKERBÄNDER



## HANDLEBAR TAPES

### VELO – GREIFEN SIE ZU

Neben Füßen und Gesäß sind Sie nur mit Ihren Händen mit dem Rad verbunden. Das Lenkerband als erste Kontaktfläche hat also eine enorme Bedeutung für das Erlebnis Fahrrad. Velo ist DER Experte für Lenkerbänder, der alle Bedürfnisse, mit einem Maximum an Erfahrung, den aktuellen technologischen Möglichkeiten und erstklassigen Materialien, befriedigt. Sie wollen zufriedene Kunden? Greifen Sie bei Velo zu!

### VELO – GET A GRIP

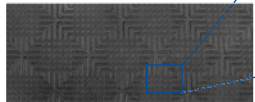
Besides your feet and buttocks you are only connected to your bike by your hands. Handlebar tape as first contact point has therefore an enormous meaning for your cycling experience. Velo is THE expert for handlebar tapes and satisfies all needs with a maximum of experience, the latest technical solutions and first class materials. You want satisfied customers? Get a Velo grip!

<b>410278</b> 100 set	<b>LENKERBAND ›KNOB GRIP‹</b> <ul style="list-style-type: none"> <li><b>besonders griffig</b> und <b>stoßabsorbierend</b> durch <b>ausgeprägte und rutschfeste Noppen-Oberflächenstruktur</b></li> <li><b>extrem reißfest</b></li> <li><b>XL:</b> 1 Set = 4 Bänder (2 x <b>200 x 3 cm</b> und 2 x <b>9 x 3 cm</b>)</li> <li>besonders lange und breite Bänder auch für Gravel Bikes, ...</li> <li>mit Lenkerendstopfen</li> <li>in Velo Eurolochbox</li> </ul>	<b>HANDLEBAR TAPE ›KNOB GRIP‹</b> <ul style="list-style-type: none"> <li><b>particularly non-slip</b> and <b>shock absorbing</b> through <b>textured non-slip knob</b> surface structure</li> <li><b>extrem tearproof</b></li> <li><b>XL:</b> 1 set = 4 tapes (2 x <b>200 x 3 cm</b> and 2 x <b>9 x 3 cm</b>)</li> <li>extra long and wide tapes also for gravel bikes, ...</li> <li>with handlebar plugs</li> <li>in Velo eurohole box</li> </ul>	    <p><b>NON-SLIP XL</b></p> <p><b>TEAR PROOF</b></p>
<b>410286</b> schwarz	<b>LENKERBAND ›GRIP‹</b> <ul style="list-style-type: none"> <li><b>besonders griffig</b> bei Feuchtigkeit durch <b>rutschfeste Oberflächenstruktur</b></li> <li>sehr <b>angenehmer Griff</b></li> <li><b>extrem reißfest</b></li> <li>1 <b>Set</b> = 4 Bänder (2 x <b>160 cm</b> + 2 x <b>9 cm</b>)</li> <li>mit Lenkerendstopfen und Klebeband</li> <li>in Velo Eurolochbox</li> </ul>	<b>HANDLEBAR TAPE ›GRIP‹</b> <ul style="list-style-type: none"> <li><b>particularly non-slip</b> under wet conditions through <b>non-slip</b> surface structure</li> <li>very <b>comfortable grip</b></li> <li><b>extrem tearproof</b></li> <li>1 <b>set</b> = 4 tapes (2 x <b>160 cm</b> + 2 x <b>9 cm</b>)</li> <li>with handlebar plugs and adhesive tapes</li> <li>in Velo eurohole box</li> </ul>	    <p><b>✓ ABSORBS VIBRATION</b></p> <p><b>✓ MAX. COMFORT</b></p> <p><b>✓ NON-SLIP</b></p> <p><b>TEAR PROOF</b></p>
<b>410287</b> weiß 100 set	schwarz	black	UVP 17,90 €
	weiß	white	UVP 14,90 €



ART.-NR.	BESCHREIBUNG	DESCRIPTION	
<b>410270</b> 100 set	<b>LENKERBAND ›GEL-KORK‹</b> • 1 <b>Set</b> = 4 Bänder (2 x 160 cm + 2 x 8,5 cm) • mit Lenkerendstopfen und Klebeband • mit <b>Gel</b> • <b>extrem reißfest</b> • besonders geeignet für <b>Gravel</b> durch gute Dämpfung • schwarz • in Velo Eurolochbox	<b>HANDLEBAR TAPE ›GEL-KORK‹</b> • 1 <b>set</b> = 4 tapes (2 x 160 cm + 2 x 8.5 cm) • with handlebar plugs and adhesive tapes • with <b>gel</b> • <b>extrem tearproof</b> • particularly suitable for <b>gravel</b> due to good cushioning • black • in Velo eurohole box	
<b>410271</b> schwarz  <b>410272</b> weiß 100 set	<b>LENKERBAND ›KORK‹</b> • 1 <b>Set</b> = 4 Bänder (2 x 160 cm + 2 x 8,5 cm) • mit Lenkerendstopfen und Klebeband • <b>extrem reißfest</b> • in Velo Eurolochbox	<b>HANDLEBAR TAPE ›KORK‹</b> • 1 <b>set</b> = 4 tapes (2 x 160 cm + 2 x 8.5 cm) • with handlebar plugs and adhesive tapes • <b>extrem tearproof</b> • in Velo eurohole box	
<b>410831</b> 40 set NICE PRICE	<b>LENKERBAND ›CLOUD TAPE BASE‹</b> • <b>strukturierte Non-Slip-Oberfläche</b> bietet angenehmes und sicheres Griffgefühl • extra <b>lang</b> und <b>breit: 200 x 3 cm</b> • 1 Set = 2 Bänder • mit Lenkerendstopfen und Klebeband • in M-Wave Eurolochbox	<b>HANDLEBAR TAPE ›CLOUD TAPE BASE‹</b> • <b>structured non-slip surface</b> provides pleasant and secure grip • extra <b>long</b> and <b>wide: 200 x 3 cm</b> • 1 set = 2 tapes • with handlebar plugs and adhesive tapes • in M-Wave eurohole box	

## LENKERENDSTOPFEN

## HANDLEBAR PLUGS



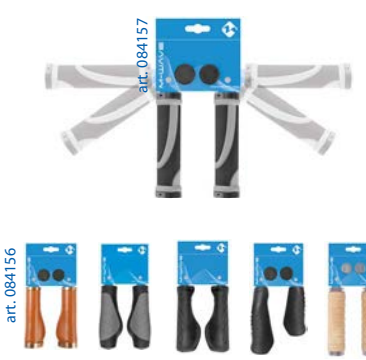
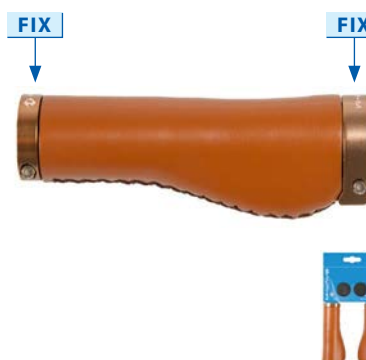





<b>410894</b> blau eloxiert  <b>410895</b> grün eloxiert 200 pair	<b>LENKERENDSTOPFEN ›A RIO‹</b> • aus <b>Aluminium</b> mit <b>Nirosta-Schraube</b> • für Innendurchmesser 17,5 - 19,5 mm • 1 Paar auf M-Wave Eurolochkarte	<b>HANDLEBAR PLUGS ›A RIO‹</b> • made of <b>aluminium</b> with <b>stainless steel screw</b> • for inner diameter 17.5 - 19.5 mm • 1 pair on M-Wave eurohole card	
<b>410897</b> 1 Set = 4 Stück auf M-Wave Eurolochkarte 200 set  • <b>410898</b> 100 Stück im Polybeutel 1.000/100	<b>LENKERENDSTOPFEN ›FIT-PLUGS‹</b> • aus <b>elastischem TPR Kunststoff</b> • durch <b>Flexibilität</b> passend für <b>viele verschiedene Innendurchmesser</b> • wiederverwendbar	<b>HANDLEBAR PLUGS ›FIT-PLUGS‹</b> • made of <b>elastic TPR plastic</b> • due to <b>flexibility</b> suitable for <b>many different inner diameters</b> • reusable	











ART.-NR.	BESCHREIBUNG	DESCRIPTION	
	<p><b>M-WAVE GRIFFE AUF EUROLOCHKARTE</b></p> <p>Sie können die beliebtesten M-Wave Griffe auch verpackt auf einer Euroloch-Griffkarte (Art. 084156/7) bekommen. Durch die <b>drehbar</b> befestigten Griffhalter kann der Endverbraucher im Geschäft die Griffe, ähnlich wie in einer <b>realen Fahrsituation</b>, in die Hand nehmen.</p>	<p><b>M-WAVE GRIPS ON EUROHOLE CARD</b></p> <p>The most popular M-Wave grips are also available on the new eurohole grip card (art. 084156/7). The grips are <b>turnable</b> on the card, so the consumer can grab the grips at the POS like in a <b>real riding situation</b>.</p>	
<p><b>410622</b> 50 pair</p> <p><b>410610</b> 100 pair</p>	<p><b>SCHRAUBGRIFF ›CLOUD BASE 2‹</b></p> <ul style="list-style-type: none"> <li>• <b>anatomisch geformter Echtlederoptik-Schraubgriff</b></li> <li>• <b>handgenäht</b></li> <li>• leichte (De-)Montage und <b>fester Halt</b> am Lenker durch <b>doppelte Aluminium-Schraubbefestigung</b></li> <li>• mit Lenkerendstopfen</li> <li>• 135 mm</li> </ul> <p>auf M-Wave Eurolochkarte</p> <p>paarweise im Polybeutel</p>	<p><b>SCREW-ON GRIP ›CLOUD BASE 2‹</b></p> <ul style="list-style-type: none"> <li>• <b>anatomically shaped genuine leather design screw-on grip</b></li> <li>• <b>handsewn</b></li> <li>• easy (dis-)assembly and <b>perfect grip</b> at the handlebar through <b>double aluminium screw attachment</b></li> <li>• with handlebar plugs</li> <li>• 135 mm</li> </ul> <p>on M-Wave eurohole card</p> <p>1 pair in PE bag</p> <p>UVP 13,90 €</p>	
<p><b>410628</b> 50 pair</p> <p><b>410603</b> 100 pair</p> <p><b>410629</b> 50 pair</p> <p><b>410604</b> 100 pair</p>	<p><b>SCHRAUBGRIFF ›CLOUD BUFF FIX‹</b></p> <ul style="list-style-type: none"> <li>• <b>anatomisch geformter Echtlederoptik-Schraubgriff</b></li> <li>• leichte (De-)Montage und <b>fester Halt</b> am Lenker durch <b>doppelte Aluminium-Schraubbefestigung</b></li> <li>• mit elastischen Lenkerendstopfen</li> </ul> <p><b>138 / 138 mm</b></p> <p>auf M-Wave Eurolochkarte</p> <p>paarweise im Polybeutel</p> <p><b>138 / 99 mm</b></p> <p>auf M-Wave Eurolochkarte</p> <p>paarweise im Polybeutel</p>	<p><b>SCREW-ON GRIP ›CLOUD BUFF FIX‹</b></p> <ul style="list-style-type: none"> <li>• <b>anatomically shaped genuine leather design screw-on grip</b></li> <li>• easy (dis-)assembly and <b>perfect grip</b> at the handlebar through <b>double aluminium screw attachment</b></li> <li>• with elastic handlebar plugs</li> </ul> <p><b>138 / 138 mm</b></p> <p>on M-Wave eurohole card</p> <p>1 pair in PE bag</p> <p><b>138 / 99 mm</b></p> <p>on M-Wave eurohole card</p> <p>1 pair in PE bag</p> <p>UVP 13,90 €</p>	
<p><b>410589</b></p> <p><b>410588</b> 100 pair</p>	<p><b>GRIFF ›CLOUD BUFF‹</b></p> <ul style="list-style-type: none"> <li>• <b>anatomisch geformter Echtlederoptikgriff</b></li> <li>• <b>handgenäht</b></li> <li>• geschlossenes Ende</li> <li>• 125 mm</li> </ul> <p>auf M-Wave Eurolochkarte</p> <p>paarweise im Polybeutel</p>	<p><b>GRIP ›CLOUD BUFF‹</b></p> <ul style="list-style-type: none"> <li>• <b>anatomically shaped genuine leather design grip</b></li> <li>• <b>handsewn</b></li> <li>• closed end</li> <li>• 125 mm</li> </ul> <p>on M-Wave eurohole card</p> <p>1 pair in PE bag</p> <p>UVP 7,90 €</p>	

ART.-NR.	BESCHREIBUNG	DESCRIPTION	
  <b>410124</b>  <b>410125</b> 40 pair	<p><b>SCHRAUBGRIFF</b> ›CLOUD ERGO MAX FIX BE‹</p> <ul style="list-style-type: none"> <li>• Komfortgriff mit extra großer <b>ergonomischer</b> Auflagefläche, die dem Abknicken der Handgelenke vorbeugt</li> <li>• <b>Zweikomponentengriff</b>: harte Mischung innen und weiche Mischung außen für Komfort und Stoßabsorbierung</li> <li>• <b>Microtech Noppen</b> für noch besseren Halt</li> <li>• <b>Aluminium-Klemme</b> und <b>integrierte 2-fache Schraubbefestigung</b> für leichte (De-)Montage und besonders festem Halt am Lenker</li> <li>• mit Lenkerendstopfen</li> <li>• 140 mm</li> </ul> <p>auf M-Wave Eurolochkarte</p> <p>im Polybeutel</p>	<p><b>SCREW-ON GRIP</b> ›CLOUD ERGO MAX FIX BE‹</p> <ul style="list-style-type: none"> <li>• comfort grip with especially wide <b>ergonomic</b> contact area, which prevents the wrists from deviating</li> <li>• <b>2-Component grip</b>: hard inner mixture and soft outer mixture for comfort and shock absorbing</li> <li>• <b>Microtech knobs</b> for still better grip</li> <li>• <b>aluminium clamp</b> and <b>integrated double screw attachment</b> for easy (dis-)assembly and perfect grip at the handlebar</li> <li>• with handlebar plugs</li> <li>• 140 mm</li> </ul> <p>on M-Wave eurohole card</p> <p>in PE bag</p> <p>UVP 29,90 €</p>	<p>Double <b>D2</b> Density</p>  <p>bottom view:</p>  <p><b>MICROTECH KNOBS</b></p> 
<p><b>410053</b> 50 pair</p> <p><b>410052</b> 80 pair</p>	<p><b>SCHRAUBGRIFF</b> ›CLOUD ERGOMAX FIX‹</p> <ul style="list-style-type: none"> <li>• <b>fest integrierte Schraubbefestigung</b> für leichte (De-)Montage und festem Halt am Lenker</li> <li>• Komfortgriff mit <b>ergonomischer Form</b>, die dem Abknicken der Handgelenke vorbeugt</li> <li>• <b>Zweikomponentengriff</b>: harte Mischung innen und weiche Mischung außen für Komfort und Stoßabsorbierung</li> <li>• <b>Microtech Noppen</b> für noch besseren Halt</li> <li>• geschlossenes Ende</li> <li>• 138 mm</li> </ul> <p>auf M-Wave Eurolochkarte</p> <p>im Polybeutel</p>	<p><b>SCREW-ON GRIP</b> ›CLOUD ERGOMAX FIX‹</p> <ul style="list-style-type: none"> <li>• <b>firmly integrated screw attachment</b> for easy (dis-)assembly and perfect grip at the handlebar</li> <li>• comfort grip with <b>ergonomic shape</b>, which prevents the wrists from deviating</li> <li>• <b>2-Component grip</b>: hard inner mixture and soft outer mixture for comfort and shock absorbing</li> <li>• <b>Microtech knobs</b> for still better grip</li> <li>• closed end</li> <li>• 138 mm</li> </ul> <p>on M-Wave eurohole card</p> <p>in PE bag</p> <p>UVP 11,90 €</p>	<p>Double <b>D2</b> Density</p>  <p>bottom view:</p>  <p><b>MICROTECH KNOBS</b></p> 
<p><b>410402</b></p> <p>• <b>410236</b> 100 pair</p>	<p><b>SCHRAUBGRIFF</b> ›CLOUD ERGO FIX 2‹</p> <ul style="list-style-type: none"> <li>• leichte (De-)Montage und <b>fester Halt</b> am Lenker durch <b>doppelte Schraubbefestigung</b></li> <li>• anatomische Form</li> <li>• mit Lenkerendstopfen</li> <li>• 130 mm</li> </ul> <p>auf M-Wave Eurolochkarte</p> <p>paarweise im Polybeutel</p>	<p><b>SCREW-ON GRIP</b> ›CLOUD ERGO FIX 2‹</p> <ul style="list-style-type: none"> <li>• easy (dis-)assembly and <b>perfect grip</b> at the handlebar through <b>double screw attachment</b></li> <li>• anatomic shape</li> <li>• with handlebar plugs</li> <li>• 130 mm</li> </ul> <p>on M-Wave eurohole card</p> <p>1 pair in PE bag</p> <p>UVP 9,90 €</p>	 

ART.-NR.	BESCHREIBUNG	DESCRIPTION	
  <b>410054</b>  <b>410055</b> 80 pair  <b>410056</b>  <b>410057</b> 80 pair	<b>SCHRAUBGRIF</b> <b>›CLOUD ERGO FIX‹</b>  <ul style="list-style-type: none"> <li>• <b>fest integrierte Schraubbefestigung</b> für leichte (De-)Montage und festem Halt am Lenker</li> <li>• Komfortgriff mit <b>ergonomischer Form</b>, die dem Abknicken der Handgelenke vorbeugt</li> <li>• <b>fließender Übergang</b> zur Klemme</li> <li>• <b>Zweikomponentengriff D2</b>: harte Mischung innen und weiche Mischung außen für Komfort und Stoßabsorbierung</li> <li>• <b>Microtech Noppen</b> für noch besseren Halt</li> <li>• geschlossenes Ende</li> </ul> <b>132 / 132 mm</b>  auf M-Wave Eurolochkarte  im Polybeutel   <b>132 / 92 mm</b> 92 mm mit <b>Innenklemmung</b>  auf M-Wave Eurolochkarte  im Polybeutel 80 pair	<b>SCREW-ON GRIP</b> <b>›CLOUD ERGO FIX‹</b>  <ul style="list-style-type: none"> <li>• <b>firmly integrated screw attachment</b> for easy (dis-)assembly and perfect grip at the handlebar</li> <li>• comfort grip with <b>ergonomic shape</b>, which prevents the wrists from deviating</li> <li>• <b>smooth transition</b> to the clamp</li> <li>• <b>2-Component grip D2</b>: hard inner mixture and soft outer mixture for comfort and shock absorbing</li> <li>• <b>Microtech knobs</b> for still better grip</li> <li>• closed end</li> </ul> <b>132 / 132 mm</b>  on M-Wave eurohole card  in PE bag UVP 10,90 €   <b>132 / 92 mm</b> 92 mm with <b>inner clamp</b>  on M-Wave eurohole card  in PE bag UVP 13,90 €	 <p>Double D2 Density</p> <p>FIX</p> <p>bottom view:</p> <p>MICROTECH KNOBS</p> <p>132 mm</p> <p>92 mm</p> <p>FIX</p>
 <b>410121</b> 50 pair • <b>410126</b> 100 pair  <b>410122</b> 50 pair • <b>410127</b> 100 pair	<b>SCHRAUBGRIF</b> <b>›CLOUD BASE 2 FIX‹</b>  <ul style="list-style-type: none"> <li>• <b>integrierte Schraubbefestigung</b> für leichte (De-)Montage und festem Halt am Lenker</li> <li>• Komfortgriff mit <b>ergonomischer Form</b>, die dem <b>Abknicken der Handgelenke</b> vorbeugt</li> <li>• <b>Zweikomponentengriff</b>: harte Mischung innen für guten Halt auf dem Lenker und weiche Mischung außen für Komfort und Stoßabsorbierung</li> <li>• geschlossenes Ende</li> </ul> <b>135 / 135 mm</b>  auf M-Wave Eurolochkarte  paarweise im Polybeutel   <b>135 / 100 mm</b>  auf M-Wave Eurolochkarte  paarweise im Polybeutel	<b>SCREW-ON GRIP</b> <b>›CLOUD BASE 2 FIX‹</b>  <ul style="list-style-type: none"> <li>• <b>integrated screw attachment</b> for easy (dis-)assembly and perfect grip at the handlebar</li> <li>• comfort grip with <b>ergonomic shape</b>, which prevents the wrists from deviating</li> <li>• <b>2-Component grip</b>: hard inner mixture for good connection with handlebar and soft outer mixture for comfort and shock absorbing</li> <li>• closed end</li> </ul> <b>135 / 135 mm</b>  on M-Wave eurohole card  1 pair in PE bag   <b>135 / 100 mm</b>  on M-Wave eurohole card  1 pair in PE bag  UVP 5,90 €	 <p>FIX</p> <p>135 mm</p> <p>100 mm</p>

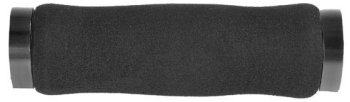
ART.-NR.	BESCHREIBUNG	DESCRIPTION	
  <b>410401</b>  <b>410489</b> 50 pair	<b>SCHRAUBGRIF</b> ›CLOUD SLICK FIX 2‹  <ul style="list-style-type: none"> <li>• <b>Zweikomponenten-Schraubgriff</b></li> <li>• leichte (De-)Montage und <b>fester Halt</b> am Lenker durch <b>doppelte Aluminium-Schraubbefestigung</b></li> <li>• mit Lenkerendstopfen</li> <li>• 130 mm</li> </ul> auf M-Wave Eurolochkarte  paarweise im Polybeutel	<b>SCREW-ON GRIP</b> ›CLOUD SLICK FIX 2‹  <ul style="list-style-type: none"> <li>• <b>2-Component screw-on grip</b></li> <li>• easy (dis-)assembly and <b>perfect grip</b> at the handlebar through <b>double aluminium screw attachment</b></li> <li>• with handlebar plugs</li> <li>• 130 mm</li> </ul> on M-Wave eurohole card  1 pair in PE bag  UVP 10,90 €	  
<b>410403</b>  • <b>410480</b> 100 pair	<b>SCHRAUBGRIF</b> ›CLOUD SLICK FIX‹  <ul style="list-style-type: none"> <li>• leichte (De-)Montage und <b>fester Halt</b> am Lenker durch <b>doppelte Schraubbefestigung</b></li> <li>• 130 mm</li> <li>• mit Lenkerendstopfen</li> </ul> auf M-Wave Eurolochkarte  paarweise im Polybeutel	<b>SCREW-ON GRIP</b> ›CLOUD SLICK FIX‹  <ul style="list-style-type: none"> <li>• easy (dis-)assembly and <b>perfect grip</b> at the handlebar through <b>double screw attachment</b></li> <li>• 130 mm</li> <li>• with handlebar plugs</li> </ul> on M-Wave eurohole card  1 pair in PE bag  UVP 6,90 €	  
<b>410123</b>  • <b>410120</b> 100 pair	<b>SCHRAUBGRIF</b> ›CLOUD SLICK FIX 4‹  <ul style="list-style-type: none"> <li>• <b>ergonomische Form</b></li> <li>• leichte (De-)Montage und <b>fester Halt</b> am Lenker durch <b>Schraubbefestigung</b></li> <li>• <b>rutschfeste</b> Gummigriffe</li> <li>• mit Lenkerendstopfen</li> <li>• 130 mm</li> </ul> auf M-Wave Eurolochkarte  paarweise im Polybeutel	<b>SCREW-ON GRIP</b> ›CLOUD SLICK FIX 4‹  <ul style="list-style-type: none"> <li>• <b>ergonomic shape</b></li> <li>• easy (dis-)assembly and <b>perfect grip</b> at the handlebar through <b>screw attachment</b></li> <li>• <b>non-slip</b> rubber grips</li> <li>• with handlebar plugs</li> <li>• 130 mm</li> </ul> on M-Wave eurohole card  1 pair in PE bag  UVP 5,90 €	  
<b>410617</b>  • <b>410618</b> 100 pair	<b>SCHRAUBGRIF</b> ›CLOUD SLICK FIX 6‹  <ul style="list-style-type: none"> <li>• leichte (De-)Montage und <b>fester Halt</b> am Lenker durch <b>Aluminium-Schraubbefestigung</b></li> <li>• <b>Zweikomponentengriff</b>: harte Mischung innen für guten Halt auf dem Lenker und weiche Mischung außen für Komfort und Stoßabsorbierung</li> <li>• mit Lenkerendstopfen</li> <li>• 130 mm</li> </ul> auf M-Wave Eurolochkarte  paarweise im Polybeutel	<b>SCREW-ON GRIP</b> ›CLOUD SLICK FIX 6‹  <ul style="list-style-type: none"> <li>• easy (dis-)assembly and <b>perfect grip</b> at the handlebar through <b>aluminium screw attachment</b></li> <li>• <b>2-Component grip</b>: hard inner mixture for good connection with handlebar and soft outer mixture for comfort and shock absorbing</li> <li>• with handlebar plugs</li> <li>• 130 mm</li> </ul> on M-Wave eurohole card  1 pair in PE bag  UVP 6,90 €	  

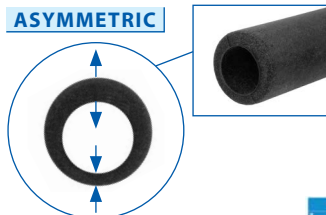

ART.-NR.	BESCHREIBUNG	DESCRIPTION	
<p><b>410316</b> 50 pair</p> <p><b>410317</b> 100 pair</p>	<p><b>SCHRAUBGRIFF ›CLOUD SLICK SHORT‹</b></p> <ul style="list-style-type: none"> <li>• <b>extra kurzer Griff: 115 mm</b></li> <li>• für kleine Hände</li> <li>• <b>fest integrierte Kunststoff-Schraubbefestigung</b> für leichte (De-)Montage und festem Halt am Lenker</li> <li>• <b>Zweikomponentengriff:</b> harte Mischung innen für guten Halt auf dem Lenker und weiche Mischung außen für Komfort und Stoßabsorbierung</li> <li>• geschlossenes Ende</li> <li>• besonders geeignet für E-Scooter</li> </ul>	<p><b>SCREW-ON GRIP ›CLOUD SLICK SHORT‹</b></p> <ul style="list-style-type: none"> <li>• <b>extra short grip: 115 mm</b></li> <li>• for small hands</li> <li>• <b>firmly integrated plastic screw attachment</b> for easy (dis-)assembly and perfect grip at the handlebar</li> <li>• <b>2-Component grip:</b> hard inner mixture for good connection with handlebar and soft outer mixture for comfort and shock absorbing</li> <li>• closed end</li> <li>• especially suitable for e-scooters</li> </ul>	<p><b>Double D2 Density</b> 115 mm</p>  <p>115 mm</p>  <p>FIX</p>  <p>UVP 8,90 €</p>
<p><b>410404</b> 50 pair</p> <p>• <b>410318</b> 100 pair</p>	<p><b>SCHAUMSTOFF-SCHRAUBGRIFF ›CLOUD SLICK FIX LIGHT‹</b></p> <ul style="list-style-type: none"> <li>• harte Mischung innen für <b>guten Halt</b> auf dem Lenker und <b>superleichte, weiche Schaumstoffauflage</b> außen für <b>Komfort</b> und <b>Stoßabsorbierung</b></li> <li>• leichte <b>(De-)Montage</b> und <b>fester Halt</b> am Lenker durch <b>doppelte Aluminium-Schraubbefestigung</b></li> <li>• nur <b>78 g/Pair</b></li> <li>• mit Lenkerendstopfen</li> <li>• 130 mm</li> </ul>	<p><b>FOAM SCREW-ON GRIP ›CLOUD SLICK FIX LIGHT‹</b></p> <ul style="list-style-type: none"> <li>• hard inner mixture for <b>good connection</b> with handlebar and <b>super light</b> soft foam outer mixture for <b>comfort</b> and <b>shock absorbing</b></li> <li>• easy <b>(dis-)assembly</b> and <b>perfect grip</b> at the handlebar through <b>double aluminium screw attachment</b></li> <li>• only <b>78 g/pair</b></li> <li>• with handlebar plugs</li> <li>• 130 mm</li> </ul>	<p><b>78 g (pair)</b></p>  <p>FIX</p>  <p>SOFT FOAM</p>  <p>UVP 5,90 €</p>
<p><b>410700</b></p> <p><b>410701</b> 100 pair</p>	<p><b>GRIFF ›CLOUD SLICK FIX 5‹</b></p> <ul style="list-style-type: none"> <li>• <b>100 % Silikon</b></li> <li>• rutschfest</li> <li>• sehr angenehme <b>Haptik</b></li> <li>• stoßabsorbierend</li> <li>• <b>asymmetrische Form</b> ermöglicht individuelle Positionierung</li> <li>• langlebig, da <b>UV-beständig</b> und waschbar</li> <li>• temperaturunempfindlich</li> <li>• 130 mm</li> <li>• mit Lenkerendstopfen</li> </ul>	<p><b>GRIP ›CLOUD SLICK FIX 5‹</b></p> <ul style="list-style-type: none"> <li>• <b>100 % silicone</b></li> <li>• non-slip</li> <li>• very pleasant <b>haptics</b></li> <li>• shock absorbing</li> <li>• <b>asymmetric form</b> enables individual positioning</li> <li>• long lasting because <b>UV-resistant</b> and washable</li> <li>• temperature insensitive</li> <li>• 130 mm</li> <li>• with handlebar plugs</li> </ul>	<p><b>SILICONE</b></p>  <p><b>ASYMMETRIC</b></p>   <p>UVP 12,90 €</p>

ART.-NR. 	BESCHREIBUNG	DESCRIPTION	
<p><b>411010</b></p> <p>• <b>411000</b> 100 pair</p>	<p><b>GRIFF ›SLR‹</b></p> <ul style="list-style-type: none"> <li>• sehr angenehme <b>Haptik</b></li> <li>• <b>atmungsaktiv</b> und <b>temperaturunempfindlich</b></li> <li>• stoßabsorbierend</li> <li>• nur <b>30 g/Pair</b> durch <b>SLR (Super Light Rubber)</b></li> <li>• mit Lenkerendstopfen</li> <li>• 130 mm</li> </ul> <p>auf M-Wave Eurolochkarte</p> <p>paarweise im Polybeutel</p>	<p><b>GRIP ›SLR‹</b></p> <ul style="list-style-type: none"> <li>• very pleasant <b>haptics</b></li> <li>• <b>breathable</b> and <b>temperature insensitive</b></li> <li>• shock absorbing</li> <li>• only <b>30 g/pair</b> by <b>SLR (Super Light Rubber)</b></li> <li>• with handlebar plugs</li> <li>• 130 mm</li> </ul> <p>on M-Wave eurohole card</p> <p>1 pair in PE bag</p> <p>UVP 4,90 €</p>	  
<p><b>410039</b></p> <p><b>410040</b> 100 pair</p>	<p><b>GRIFF ›CLOUD ERGO‹</b></p> <ul style="list-style-type: none"> <li>• Komfortgriff mit <b>ergonomischer Form</b>, die dem <b>Abknicken</b> der <b>Handgelenke</b> vorbeugt</li> <li>• <b>Zweikomponentengriff D2</b>: harte Mischung innen für guten Halt auf dem Lenker und weiche Mischung außen für Komfort und Stoßabsorbierung</li> <li>• 132 mm</li> </ul> <p>auf M-Wave Eurolochkarte</p> <p>paarweise im Polybeutel</p>	<p><b>GRIP ›CLOUD ERGO‹</b></p> <ul style="list-style-type: none"> <li>• comfort grip with <b>ergonomic shape</b>, which prevents the <b>wrists</b> from <b>bending</b></li> <li>• <b>2-Component grip D2</b>: hard inner mixture for good connection with handlebar and soft outer mixture for comfort and shock absorbing</li> <li>• 132 mm</li> </ul> <p>on M-Wave eurohole card</p> <p>1 pair in PE bag</p> <p>UVP 6,90 €</p>	 
<p><b>410531</b></p> <p>• <b>410530</b> 100 pair</p>	<p><b>GRIFF ›CLOUD BASE 3‹</b></p> <ul style="list-style-type: none"> <li>• schwarz/grau</li> <li>• Komfortgriff mit <b>ergonomischer Form</b>, die dem <b>Abknicken</b> der <b>Handgelenke</b> vorbeugt</li> <li>• geschlossenes Ende</li> <li>• 125 mm</li> </ul> <p>auf M-Wave Eurolochkarte</p> <p>paarweise im Polybeutel</p>	<p><b>GRIP ›CLOUD BASE 3‹</b></p> <ul style="list-style-type: none"> <li>• black/grey</li> <li>• comfort grip with <b>ergonomic shape</b>, which prevents the <b>wrists</b> from <b>bending</b></li> <li>• closed end</li> <li>• 125 mm</li> </ul> <p>on M-Wave eurohole card</p> <p>1 pair in PE bag</p> <p>UVP 5,90 €</p>	 
<p><b>410201</b> 50 pair</p> <p><b>410229</b> 100 pair</p>	<p><b>GRIFF ›FAT BOY‹</b></p> <ul style="list-style-type: none"> <li>• <b>Zweikomponentengriff</b></li> <li>• schwarz/grau</li> <li>• <b>weich</b> und <b>griffig</b></li> <li>• geschlossenes Ende</li> <li>• 125 mm</li> </ul> <p>auf M-Wave Eurolochkarte</p> <p>paarweise im Polybeutel</p>	<p><b>GRIP ›FAT BOY‹</b></p> <ul style="list-style-type: none"> <li>• <b>2-Component grip</b></li> <li>• black/grey</li> <li>• <b>soft</b> and <b>handy</b></li> <li>• closed end</li> <li>• 125 mm</li> </ul> <p>on M-Wave eurohole card</p> <p>1 pair in PE bag</p> <p>UVP 4,90 €</p>	 

ART.-NR.	BESCHREIBUNG	DESCRIPTION	
  <b>410203</b>  <b>410260</b> 100 pair	<b>MTB GRIFF ›CLOUD BASE 1‹</b> <ul style="list-style-type: none"> <li>• <b>Zweikomponentengriff:</b> harte Mischung innen für <b>guten Halt</b> auf dem Lenker und weiche Mischung außen für <b>Komfort, Stoßabsorbierung</b> und <b>zuverlässigen Halt</b></li> <li>• 130 mm</li> </ul> auf M-Wave Eurolochkarte  paarweise im Polybeutel	<b>MTB GRIP ›CLOUD BASE 1‹</b> <ul style="list-style-type: none"> <li>• <b>2-Component grip:</b> hard inner mixture for <b>good connection</b> with the handlebar and soft outer mixture for <b>comfort, shock absorbing</b> and <b>perfect grip</b></li> <li>• 130 mm</li> </ul> on M-Wave eurohole card  1 pair in PE bag  UVP 4,90 €	  
<b>410233</b>  • <b>410231</b> 100 pair	<b>ERGOGRIF ›CLOUD BASE 4‹</b> <ul style="list-style-type: none"> <li>• Komfortgriff mit <b>ergonomischer Form</b>, die dem <b>Abknicken der Handgelenke</b> vorbeugt</li> <li>• geschlossenes Ende</li> <li>• 130 mm</li> </ul> auf M-Wave Eurolochkarte  paarweise im Polybeutel	<b>ERGO GRIP ›CLOUD BASE 4‹</b> <ul style="list-style-type: none"> <li>• comfort grip with <b>ergonomic shape</b>, which prevents the <b>wrists</b> from <b>bending</b></li> <li>• closed end</li> <li>• 130 mm</li> </ul> on M-Wave eurohole card  1 pair in PE bag  UVP 3,90 €	  
<div style="background-color: #0070c0; color: white; padding: 2px; font-weight: bold;">NICE PRICE</div>  <b>410524</b> • <b>410523</b>  <b>410539</b> • <b>410540</b>  <b>410522</b> • <b>410521</b> 100 pair	<b>GRIF ›CLOUD BASE 2‹</b> <ul style="list-style-type: none"> <li>• Komfortgriff mit <b>ergonomischer Form</b>, die dem <b>Abknicken der Handgelenke</b> vorbeugt</li> <li>• geschlossenes Ende</li> </ul> <b>schwarz, 130 / 130 mm</b> auf M-Wave Eurolochkarte paarweise im Polybeutel  <b>schwarz, 130 / 95 mm</b> auf M-Wave Eurolochkarte paarweise im Polybeutel  <b>braun, 130 / 130 mm</b> auf M-Wave Eurolochkarte paarweise im Polybeutel	<b>GRIP ›CLOUD BASE 2‹</b> <ul style="list-style-type: none"> <li>• comfort grip with <b>ergonomic shape</b>, which prevents the <b>wrists</b> from <b>bending</b></li> <li>• closed end</li> </ul> <b>black, 130 / 130 mm</b> on M-Wave eurohole card 1 pair in PE bag  <b>black, 130 / 95 mm</b> on M-Wave eurohole card 1 pair in PE bag  <b>brown, 130 / 130 mm</b> on M-Wave eurohole card 1 pair in PE bag  UVP 3,90 €	   ← 130 mm →    ← 95 mm →    
• <b>410527</b>  • <b>410528</b> <b>410529</b> 100 pair	<b>GRIF ›ERGOGEL‹</b> <ul style="list-style-type: none"> <li>• Komfortgriff mit <b>ergonomischer Form</b>, die dem <b>Abknicken der Handgelenke</b> vorbeugt</li> <li>• Negativprofil gibt bei Nässe <b>Halt</b></li> <li>• mit Lenkerendstopfen</li> </ul> <b>131 / 131 mm</b> paarweise im Polybeutel  <b>131 / 92 mm</b> paarweise im Polybeutel auf M-Wave Eurolochkarte	<b>GRIP ›ERGOGEL‹</b> <ul style="list-style-type: none"> <li>• comfort grip with <b>ergonomic shape</b>, which prevents the <b>wrists</b> from <b>bending</b></li> <li>• negative profile <b>avoids additional slipping</b> at wet conditions</li> <li>• with handlebar plugs</li> </ul> <b>131 / 131 mm</b> 1 pair in PE bag  <b>131 / 92 mm</b> 1 pair in PE bag on M-Wave eurohole card  UVP 3,90 €	   

ART.-NR. 	BESCHREIBUNG	DESCRIPTION	
<p><b>410212</b> auf M-Wave Eurolochkarte 50 pair</p> <p>• <b>410262</b> paarweise im Polybeutel 200 pair</p>	<p><b>GRIFF ›CLOUD TIRE 1‹</b></p> <ul style="list-style-type: none"> <li>• schwarz</li> <li>• griffige <b>Feinnoppen</b>-Struktur gibt <b>guten Halt</b></li> <li>• geschlossenes Ende</li> <li>• 125 mm</li> </ul>	<p><b>GRIP ›CLOUD TIRE 1‹</b></p> <ul style="list-style-type: none"> <li>• black</li> <li>• non-slip <b>fine knob</b> structure gives <b>good grip</b></li> <li>• closed end</li> <li>• 125 mm</li> </ul>	  <p>UVP 3,90 €</p>
<p><b>410007</b> 200 pair</p>	<p><b>GRIFF</b> ›Grip Shift 102‹, 102 mm</p>	<p><b>GRIP</b> ›Grip Shift 102‹, 102 mm</p>	 <p>UVP 3,90 €</p>
<p><b>410018</b> 200 pair</p>	<p>›Grip Shift 90‹, 90 mm</p>	<p>›Grip Shift 90‹, 90 mm</p>	 <p>UVP 3,90 €</p> <p>90 mm</p>
<p><b>410213</b> auf M-Wave Eurolochkarte 100 pair</p> <p>• <b>410263</b> paarweise im Polybeutel 200 pair</p>	<p><b>GRIFF ›CLOUD SLICK‹</b></p> <ul style="list-style-type: none"> <li>• schwarz</li> <li>• geschlossenes Ende</li> <li>• <b>130 / 85 mm</b></li> </ul>	<p><b>GRIP ›CLOUD SLICK‹</b></p> <ul style="list-style-type: none"> <li>• black</li> <li>• closed end</li> <li>• <b>130 / 85 mm</b></li> </ul>	 <p>130 mm</p>  <p>85 mm</p>  <p>UVP 3,90 €</p>
<p><b>410214</b> auf M-Wave Eurolochkarte 200 pair</p> <p>• <b>410264</b> paarweise im Polybeutel 200 pair</p>	<p><b>130 mm</b></p>	<p><b>130 mm</b></p>	 <p>130 mm</p>  <p>UVP 3,90 €</p>
<p>• <b>410252</b> 200 pair</p>	<p><b>WEICHPLASTIKGRIFF</b></p> <ul style="list-style-type: none"> <li>• schwarz</li> <li>• geschlossenes Ende</li> <li>• 125 mm</li> <li>• paarweise im Polybeutel</li> </ul>	<p><b>SOFT PLASTIC GRIP</b></p> <ul style="list-style-type: none"> <li>• black</li> <li>• closed end</li> <li>• 125 mm</li> <li>• 1 pair in PE bag</li> </ul>	 <p>UVP 2,90 €</p>
<p><b>NICE PRICE</b></p> <p><b>410241</b> auf M-Wave Eurolochkarte</p> <p>• <b>410242</b> paarweise im Polybeutel 200 pair</p>	<p><b>GRIFF ›CLOUD TIRE 2‹</b></p> <ul style="list-style-type: none"> <li>• griffige Struktur gibt <b>guten Halt</b></li> <li>• geschlossenes Ende</li> <li>• 120 mm</li> </ul>	<p><b>GRIP ›CLOUD TIRE 2‹</b></p> <ul style="list-style-type: none"> <li>• non-slip structure gives <b>good grip</b></li> <li>• closed end</li> <li>• 120 mm</li> </ul>	  <p>UVP 2,90 €</p>

















ART.-NR.	BESCHREIBUNG	DESCRIPTION	
<b>410215</b> 100 pair	<b>BMX GRIFF</b> <ul style="list-style-type: none"> <li>• <b>extra breiter</b> und <b>griffiger</b> BMX-Griff</li> <li>• <b>135 mm</b></li> <li>• <b>Abrutschsicherung</b> innen</li> <li>• geschlossenes Ende</li> <li>• paarweise im Polybeutel</li> </ul>	<b>BMX GRIP</b> <ul style="list-style-type: none"> <li>• <b>extra wide</b> and <b>handy</b> BMX grip</li> <li>• <b>135 mm</b></li> <li>• <b>slipping protection</b> at the inner end</li> <li>• closed end</li> <li>• 1 pair in PE bag</li> </ul> UVP 3,90 €	
<b>410220</b> schwarz <b>410221</b> weiß <b>410222</b> blau <b>410223</b> rot <b>410224</b> orange <b>410225</b> gelb <b>410226</b> pink <b>410227</b> grün 100 pair	<b>BMX GRIFF</b> <ul style="list-style-type: none"> <li>• breiter und <b>griffiger</b> (BMX-) Griff</li> <li>• <b>Abrutschsicherung</b> innen</li> <li>• geschlossenes Ende</li> <li>• 130 mm</li> <li>• paarweise im Polybeutel</li> </ul>	<b>BMX GRIP</b> <ul style="list-style-type: none"> <li>• wide and <b>handy</b> (BMX) grip</li> <li>• <b>slipping protection</b> at the inner end</li> <li>• closed end</li> <li>• 130 mm</li> <li>• 1 pair in PE bag</li> </ul> UVP 3,90 €	 
<b>410555</b> auf M-Wave Eurolochkarte <b>410556</b> Montageverpackung 100 pair	<b>GRIFF ›HEXFOAM‹</b> <ul style="list-style-type: none"> <li>• <b>hexagonale</b> Form</li> <li>• nur <b>44 g/</b>Paar</li> <li>• aus leichtem <b>High-Density-Schaum</b></li> <li>• mit Lenkerendstopfen</li> <li>• 125 mm</li> </ul>	<b>GRIP ›HEXFOAM‹</b> <ul style="list-style-type: none"> <li>• <b>hexagonal</b> shape</li> <li>• only <b>44 g/</b>pair</li> <li>• light <b>high density foam</b></li> <li>• with handlebar plugs</li> <li>• 125 mm</li> </ul> UVP 3,90 €	
<b>410322</b> 250 pair	<b>SCHAUMSTOFF GRIFF</b> <ul style="list-style-type: none"> <li>• nur <b>28 g/</b>Paar</li> <li>• mit Lenkerendstopfen</li> <li>• 120 mm</li> <li>• paarweise im Polybeutel</li> </ul>	<b>FOAM GRIP</b> <ul style="list-style-type: none"> <li>• only <b>28 g/</b>pair</li> <li>• with handlebar plugs</li> <li>• 120 mm</li> <li>• 1 pair in PE bag</li> </ul> UVP 1,90 €	
<b>410399</b> 100/10 pair	<b>SCHAUMSTOFF-LENKERHÜLLE</b> <ul style="list-style-type: none"> <li>• <b>380 mm</b> Schlauch</li> <li>• aus Schaumstoff</li> <li>• mit Lenkerendstopfen</li> <li>• paarweise im Polybeutel</li> </ul>	<b>FOAM HANDLEBAR COVER</b> <ul style="list-style-type: none"> <li>• <b>380 mm</b> tube</li> <li>• made of foam</li> <li>• with handlebar plugs</li> <li>• 1 pair in PE bag</li> </ul> UVP 3,90 €	
<b>410254</b> 150 pair	<b>WEICHPLASTIKGRIFF</b> <ul style="list-style-type: none"> <li>• mit <b>Griffmulden</b></li> <li>• 110 mm</li> </ul>	<b>SOFT PLASTIC GRIP</b> <ul style="list-style-type: none"> <li>• with <b>fingerform</b></li> <li>• 110 mm</li> </ul> UVP 1,90 €	
<b>410010</b> 200 pair	<b>KINDER-/JUGENDGRIFF</b> <ul style="list-style-type: none"> <li>• mit <b>Sicherheitsende</b></li> <li>• geschlossenes Ende</li> <li>• 71 / 96 mm</li> <li>• paarweise im Polybeutel</li> </ul>	<b>CHILDREN/JUVENILE GRIP</b> <ul style="list-style-type: none"> <li>• with <b>protection end</b></li> <li>• closed end</li> <li>• 71 / 96 mm</li> <li>• 1 pair in PE bag</li> </ul> UVP 1,90 €	

# BELLS











ART.-NR.	BESCHREIBUNG	DESCRIPTION	
<p><b>NEW</b></p> <p><b>420651</b> 50</p> <p><b>420650</b> 200</p> <p><b>420654</b> 50</p> <p><b>420653</b> 200</p>	<p><b>KLINGEL FÜR AIRTAG</b> ›AIRBELL‹</p> <ul style="list-style-type: none"> <li>• unauffälliger <b>Halter für den Apple AirTag Sender in Klingelform</b></li> <li>• schwarz</li> <li>• Ersatzklöppel Art. 420656</li> </ul> <p>Lenkerklemmung <b>Ø 22 mm</b> auf AirBell Eurolochkarte</p> <p>Lenkerklemmung <b>Ø 31,8 mm</b> auf AirBell Eurolochkarte</p> <p>Montageverpackung</p>	<p><b>BELL FOR AIRTAG</b> ›AIRBELL‹</p> <ul style="list-style-type: none"> <li>• inconspicuous <b>bell-shaped holder for the Apple AirTag transmitter</b></li> <li>• black</li> <li>• spare lever art. 420656</li> </ul> <p>handlebar clamp <b>Ø 22 mm</b> on AirBell eurohole card</p> <p>OEM</p> <p>UVP 19,90 €</p> <p>handlebar clamp <b>Ø 31.8 mm</b> on AirBell eurohole card</p> <p>OEM</p> <p>UVP 22,90 €</p>	   
<p><b>420451</b></p> <p><b>420450</b> 100</p>	<p><b>KUPFERKLINGEL</b> ›BELLA C-YELL‹</p> <ul style="list-style-type: none"> <li>• <b>sehr lauter und langanhaltender Klang (85 dB)</b></li> <li>• Ø 30 mm</li> <li>• inkl. 3M Einlegegummi</li> <li>• in M-Wave Eurolochbox</li> </ul> <ul style="list-style-type: none"> <li>• schwarz</li> <li>• gemäß <b>DIN 33946 für E-Bikes zugelassen</b></li> </ul> <p>silber</p>	<p><b>COPPER BELL</b> ›BELLA C-YELL‹</p> <ul style="list-style-type: none"> <li>• <b>very loud and long lasting sound (85 dB)</b></li> <li>• Ø 30 mm</li> <li>• incl. 3M rubber inlay</li> <li>• in M-Wave eurohole box</li> </ul> <ul style="list-style-type: none"> <li>• black</li> <li>• <b>approved for e-bikes according to DIN 33946</b></li> </ul> <p>silver</p>	<p><b>TOP SOUND</b></p>    
<p><b>420033</b> 250/10</p>	<p><b>ALUMINIUMKLINGEL</b></p> <p><b>Japan Qualität</b></p> <ul style="list-style-type: none"> <li>• schwarz</li> <li>• sehr <b>lauter, heller und langanhaltender</b> Klang</li> <li>• Ø 43 mm</li> <li>• Montageverpackung</li> </ul>	<p><b>ALUMINIUM BELL</b></p> <p><b>Japan quality</b></p> <ul style="list-style-type: none"> <li>• black</li> <li>• very <b>loud, light and long lasting</b> sound</li> <li>• Ø 43 mm</li> <li>• OEM</li> </ul> <p>UVP 5,90 €</p>	<p><b>TOP SOUND</b></p>  <p><b>MADE IN JAPAN</b></p> 
<p><b>420061</b> 250</p>	<p><b>MESSINGKLINGEL</b> ›BELLA SUPER MINI‹</p> <ul style="list-style-type: none"> <li>• XS-Klingel, Ø 23 mm</li> <li>• sehr <b>lauter und langanhaltender</b> Klang</li> <li>• Klingel vom Halter <b>abnehmbar</b></li> <li>• verstellbarer <b>Universalhalter</b> von Ø 22 - 31,8 mm</li> <li>• schwarz</li> <li>• auf M-Wave Eurolochkarte</li> </ul>	<p><b>BRASS BELL</b> ›BELLA SUPER MINI‹</p> <ul style="list-style-type: none"> <li>• XS bell, Ø 23 mm</li> <li>• very <b>loud and long lasting</b> sound</li> <li>• bellbody <b>detachable</b></li> <li>• adjustable <b>universal bracket</b> from Ø 22 - 31.8 mm</li> <li>• black</li> <li>• on M-Wave eurohole card</li> </ul> <p>UVP 6,90 €</p>	<p><b>TOP SOUND</b></p>  <p><b>XS</b></p>    <p><b>ADJUSTABLE</b></p> 



ART.-NR.	BESCHREIBUNG	DESCRIPTION	
<b>420175</b> 200/10	<b>STEUERSATZKLINGEL</b> <ul style="list-style-type: none"> <li>• <b>Aluminium</b></li> <li>• zur Montage an 1 1/8" Gabelschaft/ Steuersatz</li> <li>• schwarz</li> <li>• Montageverpackung</li> </ul>	<b>HEAD SET BELL</b> <ul style="list-style-type: none"> <li>• <b>aluminium</b></li> <li>• for mounting at 1 1/8" steerer/ headset</li> <li>• black</li> <li>• OEM</li> </ul>	
<b>420053</b> 200 <b>420099</b> <b>420098</b> 200/20	<b>MESSINGKLINGEL ›BELLA DING-DONG‹</b> <ul style="list-style-type: none"> <li>• Ø 33 mm</li> <li>• sehr <b>lauter und langanhaltender</b> Klang</li> <li>• auf M-Wave Eurolochkarte</li> </ul>	<b>BRASS BELL ›BELLA DING-DONG‹</b> <ul style="list-style-type: none"> <li>• Ø 33 mm</li> <li>• very <b>loud and long lasting</b> sound</li> <li>• on M-Wave eurohole card</li> </ul>	<div style="display: flex; align-items: center;"> <div style="border: 1px solid blue; padding: 2px; margin-right: 5px;"> <b>TOP SOUND</b>   </div>  <div style="margin-left: 10px;">  </div> </div> <div style="display: flex; justify-content: space-around; margin-top: 10px;">    </div>
<b>420201</b> <b>420202</b> 200/20	<b>MINIKLINGEL ›SOCCER‹</b> <ul style="list-style-type: none"> <li>• <b>Aluminium</b></li> <li>• mit „Schuh“-Federklöppel</li> <li>• im <b>Länderflaggen-Design</b></li> <li>• ca. Ø 38 mm</li> <li>• auf M-Wave Eurolochkarte</li> </ul>	<b>MINI BELL ›SOCCER‹</b> <ul style="list-style-type: none"> <li>• <b>aluminium</b></li> <li>• with "shoe" spring lever</li> <li>• in <b>national flag design</b></li> <li>• approx. Ø 38 mm</li> <li>• on M-Wave eurohole card</li> </ul>	<div style="display: flex; align-items: center;">  <div style="margin-left: 10px;">  </div> </div> <div style="display: flex; justify-content: space-around; margin-top: 10px;"> <div style="text-align: center;">  <p>Art.-420202</p> </div> <div style="text-align: center;">  <p>Art.-420201</p> </div> </div>
<b>420103</b> 200/10	<b>MINIKLINGEL ›SOCCER‹</b> <ul style="list-style-type: none"> <li>• mit „Schuh“-Federklöppel</li> <li>• ca. Ø 38 mm</li> <li>• Montageverpackung</li> </ul>	<b>MINI BELL ›SOCCER‹</b> <ul style="list-style-type: none"> <li>• with "shoe" spring lever</li> <li>• approx. Ø 38 mm</li> <li>• OEM</li> </ul>	
<b>420084</b> 200/20	<b>ALUMINIUMKLINGEL ›COMPASS‹</b> <ul style="list-style-type: none"> <li>• mit <b>Kompass</b></li> <li>• schwarz</li> <li>• Federklöppel um <b>360° drehbar</b></li> <li>• Montageverpackung</li> </ul>	<b>ALUMINIUM BELL ›COMPASS‹</b> <ul style="list-style-type: none"> <li>• with <b>compass</b></li> <li>• black</li> <li>• spring lever <b>360° turnable</b></li> <li>• OEM</li> </ul>	
<b>420150</b> 200/20	<b>MINIKLINGEL UNIVERSAL</b> <ul style="list-style-type: none"> <li>• <b>Aluminium</b></li> <li>• universelle <b>werkzeuglose</b> Montage durch wiederverwendbare <b>Schlauchbinderklemme</b></li> <li>• passend für Ø 22,2 - 31,8 mm</li> <li>• <b>360° drehbar</b></li> <li>• schwarz</li> <li>• Montageverpackung</li> </ul>	<b>MINI BELL UNIVERSAL</b> <ul style="list-style-type: none"> <li>• <b>aluminium</b></li> <li>• universal <b>toolless</b> mounting by reusable <b>pipe clamp</b></li> <li>• suitable for Ø 22.2 - 31.8 mm</li> <li>• <b>360° turnable</b></li> <li>• black</li> <li>• OEM</li> </ul>	<div style="display: flex; align-items: center;">   </div>



ART.-NR.	BESCHREIBUNG	DESCRIPTION	
	 <b>MINIKLINGEL ›BELLA DOME‹</b> <ul style="list-style-type: none"> <li>• ca. Ø 34 mm</li> <li>• lauter und langanhaltender Klang</li> <li>• <b>360° drehbar</b></li> <li>• <b>universelle, schnelle und werkzeuglose</b> Montage am Lenker, Vorbau, Gabelschaft, ...</li> </ul>	<b>MINI BELL ›BELLA DOME‹</b> <ul style="list-style-type: none"> <li>• approx. Ø 34 mm</li> <li>• loud and long lasting sound</li> <li>• <b>360° turnable</b></li> <li>• <b>universal, quick and toolless</b> mounting at the handlebar, stem, steerer, ...</li> </ul>	 
<b>420063</b>	<ul style="list-style-type: none"> <li>• mit <b>zusätzlichem Befestigungsring</b> für unterschiedliche Ø</li> <li>• auf M-Wave Eurolochkarte</li> </ul>	<ul style="list-style-type: none"> <li>• with <b>additional mounting ring</b> for different Ø</li> <li>• on M-Wave eurohole card</li> </ul>	 
<b>420068</b>	Montageverpackung	OEM	
	200/20	UVP 2,90 €	
<b>420069</b>	Ersatz-Befestigungsring, Ø 42 mm	replacement mounting ring, Ø 42 mm	
	200	UVP 0,29 €	
<b>420177</b>	<b>MINIKLINGEL</b> <ul style="list-style-type: none"> <li>• <b>Aluminium</b></li> <li>• Ø 35 mm</li> <li>• <b>universeller Gummibandhalter</b> für viele verschiedene Durchmesser</li> <li>• <b>universelle, schnelle und werkzeuglose</b> Montage am Lenker, Vorbau, Gabelschaft, ...</li> <li>• <b>360° drehbar</b></li> <li>• Montageverpackung</li> </ul>	<b>MINI BELL</b> <ul style="list-style-type: none"> <li>• <b>aluminium</b></li> <li>• Ø 35 mm</li> <li>• <b>universal rubber band holder</b> for many different diameters</li> <li>• <b>universal, quick and toolless</b> mounting at the handlebar, stem, steerer, ...</li> <li>• <b>360° turnable</b></li> <li>• OEM</li> </ul>	 
	200	UVP 1,90 €	

  
**M-WAVE**

## YOUR WORLD OF CYCLING



ART.-NR. 	BESCHREIBUNG	DESCRIPTION	
<b>420030</b> 300/20	<b>MINIKLINGELSORTIMENT</b> <ul style="list-style-type: none"> <li>• <b>bedruckt</b></li> <li>• mit verschiedenen Motiven</li> <li>• im M-Wave Thekendisplay</li> </ul> 	<b>MINI BELLS ASSORTMENT</b> <ul style="list-style-type: none"> <li>• <b>with imprints</b></li> <li>• in different designs</li> <li>• in M-Wave sales display</li> </ul> 	 
	<b>MINIKLINGEL ›BELLA DESIGN‹</b> <ul style="list-style-type: none"> <li>• <b>Aluminium</b></li> <li>• ca. Ø 36 mm</li> <li>• sehr <b>lauter</b> und <b>langanhaltender</b> Klang</li> <li>• Klöppel 360° drehbar</li> <li>• mit metrischer Schraube</li> </ul> <p>auf M-Wave Eurolochkarte</p>	<b>MINI BELL ›BELLA DESIGN‹</b> <ul style="list-style-type: none"> <li>• <b>aluminium</b></li> <li>• approx. Ø 36 mm</li> <li>• very <b>loud</b> and <b>long lasting</b> sound</li> <li>• lever 360° turnable</li> <li>• with metric screw</li> </ul> <p>on M-Wave eurohole card</p>	<div data-bbox="1182 636 1283 734"> <p>TOP SOUND</p>  </div>   
<b>420067</b> gold <b>420066</b> schwarz <b>420142</b> weiß <b>420143</b> rot <b>420144</b> blau <b>420145</b> grün <b>420147</b> orange <b>420148</b> pink 200/20		gold black white red blue green orange pink	
<b>420064</b> 200	schwarz, Montageverpackung	black, OEM	
<b>420052</b> 200/20	<b>MINIKLINGEL</b> <ul style="list-style-type: none"> <li>• <b>Aluminium</b></li> <li>• Ø 35 mm</li> <li>• gemäß <b>DIN 33946</b> getestet und somit für <b>E-Bikes zugelassen</b></li> <li>• bis 92 db</li> <li>• Klöppel 360° drehbar, mit Klick-Funktion</li> <li>• Montageverpackung</li> </ul>	<b>MINI BELL</b> <ul style="list-style-type: none"> <li>• <b>aluminium</b></li> <li>• Ø 35 mm</li> <li>• tested according to <b>DIN 33946</b> and therefore <b>approved for e-bikes</b></li> <li>• up to 92 db</li> <li>• lever 360° turnable, with click function</li> <li>• OEM</li> </ul> <p><a href="#">according to DIN 33946</a></p>	<div data-bbox="1182 1503 1283 1601"> <p>TOP SOUND</p>  </div>  
<b>420122</b> schwarz <b>420127</b> silber <b>420128</b> farbig sortiert 200/20	<b>MINIKLINGEL</b> <ul style="list-style-type: none"> <li>• <b>Aluminium</b></li> <li>• mit <b>metrischer Schraube</b></li> <li>• Klöppel 360° drehbar</li> </ul>	<b>MINI BELL</b> <ul style="list-style-type: none"> <li>• <b>aluminium</b></li> <li>• with <b>metric screw</b></li> <li>• lever 360° turnable</li> </ul>	  

ART.-NR.	BESCHREIBUNG	DESCRIPTION	
 • <b>420023</b> 200/20 <b>NICE PRICE</b>	<b>MINIKLINGEL</b> • <b>Stahl</b> • mit <b>metrischer Schraube</b> • Klöppel 360° drehbar • Montageverpackung  schwarz	<b>MINI BELL</b> • <b>steel</b> • with <b>metric screw</b> • lever 360° turnable • OEM  black	  UVP 1,90 €
<b>420026</b> 200/20	<b>›Bella Mini-Black‹</b> • schwarz • 20 Stück im <b>M-Wave Thekendisplay</b>	<b>›Bella Mini-Black‹</b> • black • 20 pieces in <b>M-Wave sales display</b>	  UVP 1,90 €
<b>420024</b> 200/20 <b>420022</b> 400/10 <b>420035</b> 200/20	Montageverpackung  verchromt  weiß  farbig sortiert	OEM  c. p.  white  assorted colours	  UVP 1,90 €
<b>420025</b> 200/20	• <b>Pastelltöne</b> , farbig sortiert • weißes Unterteil • 20 Stk. im <b>M-Wave Thekendisplay</b>	• <b>pastel shades</b> , assorted colours • white bottom • 20 pcs. in <b>M-Wave sales display</b>	    UVP 1,90 €
<b>420092</b> 200/20	<b>MINIKLINGEL</b> • Stahl • mit <b>selbstschneidender</b> Schraube • Klöppel 360° drehbar • schwarz • Montageverpackung	<b>MINI BELL</b> • steel • with <b>self thread cutting</b> screw • lever 360° turnable • black • OEM	  UVP 1,90 €
<b>420181</b> 240/24	<b>›DING-DONG‹</b> • <b>Aluminium</b> -Oberschale • silber eloxiert • schwarzer Kunststoffsockel • Montageverpackung	<b>›DING-DONG‹</b> • <b>aluminium</b> body • silver anodised • black plastic clamp • OEM	 UVP 1,90 €

ART.-NR.	BESCHREIBUNG	DESCRIPTION	
<p><b>420324</b></p> <p><b>420322</b></p> <p><b>420330</b></p> <p><b>420325</b></p> <p><b>420306</b></p> <p><b>420307</b></p> <p><b>420308</b></p> <p><b>420320</b></p> <p><b>420311</b> 40/20</p>	<p><b>KLINGEL ›MAXI DING-DONG‹</b></p> <ul style="list-style-type: none"> <li>• Ø 80 mm</li> <li>• auf M-Wave Eurolochkarte</li> </ul> <p><b>Messing</b>, sehr <b>lauter</b> und lang <b>anhaltender</b> Klang</p> <p><b>Stahl</b></p> <p>Fluo, mit <b>fluoreszierenden</b> Punkten, ca. 1 Std. Leuchtdauer</p> <p>I Love My Bike</p> <p>Apps</p> <p>Newspaper</p> <p>Umbrella</p> <p>Sunflower</p> <p>Ladybird</p> <p>Smile</p>	<p><b>BELL ›MAXI DING-DONG‹</b></p> <ul style="list-style-type: none"> <li>• Ø 80 mm</li> <li>• on M-Wave eurohole card</li> </ul> <p><b>brass</b>, very <b>loud</b> and long <b>lasting</b> sound</p> <p><b>steel</b></p> <p>Fluo, with <b>fluorescent</b> dots, approx. 1 h glowing time</p> <p>I Love My Bike</p> <p>Apps</p> <p>Newspaper</p> <p>Umbrella</p> <p>Sunflower</p> <p>Ladybird</p> <p>Smile</p>	 <p>TOP SOUND </p> <p>Ø 80 mm </p>          
<p><b>420313</b> 40/8</p>	<p>sortiert, im M-Wave-Thekendisplay (8 Stück), Sortierung wird regelmäßig aktualisiert.</p>	<p>assorted, in M-Wave sales display (8 pcs), sorting will be updated regularly.</p>	
<p><b>420302</b> 60/6</p> <p><b>420314</b> 120/5</p>	<p><b>KLINGEL ›MAXI DING-DONG B‹</b></p> <ul style="list-style-type: none"> <li>• Stahl</li> <li>• Montageverpackung</li> </ul> <p>Ø 80 mm</p> <p>Ø 65 mm</p>	<p><b>BELL ›MAXI DING-DONG B‹</b></p> <ul style="list-style-type: none"> <li>• steel</li> <li>• OEM</li> </ul> <p>Ø 80 mm</p> <p>Ø 65 mm</p>	





ART.-NR. 	BESCHREIBUNG	DESCRIPTION	
<b>420115</b> 100/5	<b>MOTIVKLINGEL ›I LOVE MY BIKE‹</b> <ul style="list-style-type: none"> <li>• Stahl</li> <li>• schwarz</li> <li>• Montageverpackung</li> </ul>	<b>MOTIVE BELL ›I LOVE MY BIKE‹</b> <ul style="list-style-type: none"> <li>• steel</li> <li>• black</li> <li>• OEM</li> </ul>	 <p style="text-align: right;">UVP 2,90 €</p>
<b>420138</b> Wassermelone  <b>420139</b> Orange  <b>420125</b> Black fancy  <b>420124</b> White fancy  <b>420121</b> I love my bike 120/6 <b>420123</b> Smile 120	<b>KLINGEL ›BELLA 3D‹</b> <ul style="list-style-type: none"> <li>• Stahl</li> <li>• mit verschiedenen <b>3D-Motiven</b></li> <li>• Kunststoffunterteil mit 2 Schrauben</li> </ul> <b>auf M-Wave Eurolochkarte</b>	<b>BELL ›BELLA 3D‹</b> <ul style="list-style-type: none"> <li>• steel</li> <li>• with several <b>3D pictures</b></li> <li>• plastic base with 2 screws</li> </ul> <b>on M-Wave eurohole card</b>	       <p style="text-align: right;">UVP 2,90 €</p>
<b>420119</b> 120/6	<b>Kinder-Klingeln</b> , farbig sortiert, 6 Stück in neutralem Karton	<b>children bells</b> , coloured assorted, 6 pieces in neutral box	      <p style="text-align: right;">UVP 2,90 €</p>
<b>420197</b> Horse  <b>420198</b> Soccer  <b>420199</b> Smile 120/10	<b>Montageverpackung</b>	<b>OEM</b>	   <p style="text-align: right;">UVP 2,90 €</p>

ART.-NR.	BESCHREIBUNG	DESCRIPTION	
  <b>420190</b>  <b>420114</b> 240/12	<b>KINDERKLINGELSORTIMENT</b> <ul style="list-style-type: none"> <li>• Stahl</li> <li>• farbig sortiert</li> <li>• mit verschiedenen Kindermotiven</li> </ul> 12 Stück im M-Wave Thekendisplay  12 Stück im neutralen Innenkarton	<b>CHILDREN BELLS ASSORTMENT</b> <ul style="list-style-type: none"> <li>• steel</li> <li>• assorted colours</li> <li>• with different designs for kids</li> </ul> 12 pcs in M-Wave sales display  12 pcs in a neutral box  	     UVP 2,90 €
<b>420600</b> <b>420601</b> 200	<b>KLINGEL ›BELLA AROUND‹</b> <ul style="list-style-type: none"> <li>• <b>DrehKlingel</b> zur Montage um den Lenker</li> <li>• <b>Rechts-/ oder Linksmontage</b> möglich</li> <li>• besonders <b>stabil</b> und <b>unempfindlich</b> gegen Stürze, etc.</li> <li>• <b>erschwert Diebstahl</b></li> <li>• geeignet für <b>Bike Sharing, Verleih</b>, etc.</li> <li>• einfache Klemmbefestigung für Lenker Ø 22,2 mm</li> <li>• Montageverpackung</li> </ul> schwarz silber	<b>BELL ›BELLA AROUND‹</b> <ul style="list-style-type: none"> <li>• <b>twisting bell</b> for mounting around the handlebar</li> <li>• <b>right or left mounting</b> possible</li> <li>• particularly <b>stable</b> and <b>insensitive</b> to falls, etc.</li> <li>• <b>complicates theft</b></li> <li>• suitable for <b>bike sharing, rental</b>, etc.</li> <li>• easy clamp mounting for handlebar Ø 22.2 mm</li> <li>• OEM</li> </ul> black silver  UVP 2,90 €	<b>ANTI-THEFT-DESIGN</b> 
<b>420195</b> 50	<b>RADLAUFKLINGEL</b> <ul style="list-style-type: none"> <li>• Stahl</li> <li>• verchromt</li> <li>• ermöglicht besonders <b>lautes Dauerklingeln</b></li> <li>• Fernbedienung durch Lenkerschalter</li> <li>• in Ventura Eurolochbox</li> </ul> Verkauf und Nutzung im Geltungsbereich der StVZO (Deutschland) unzulässig (Abgabe nur an außerdeutsche Kunden).	<b>TIRE BELL</b> <ul style="list-style-type: none"> <li>• steel</li> <li>• c. p.</li> <li>• makes very <b>loud steady ringing</b> possible</li> <li>• remote control by handlebar switch</li> <li>• in Ventura eurohole box</li> </ul> UVP 8,90 €	  
<b>420270</b> 40/20	<b>ELEKTRISCHE KLINGEL</b> <ul style="list-style-type: none"> <li>• Lautstärke <b>120 db</b></li> <li>• <b>werkzeuglose Montage</b></li> <li>• passend für Lenker mit Ø <b>22,2 - 31,8 mm</b></li> <li>• <b>wasserfest</b></li> <li>• inkl. Batterie (Art. 640824)</li> <li>• in M-Wave Blisterverpackung</li> <li>• 20 Stück im <b>M-Wave Thekendisplay</b></li> </ul> Verkauf und Nutzung im Geltungsbereich der StVZO (Deutschland) unzulässig (Abgabe nur an außerdeutsche Kunden).	<b>ELECTRO BELL</b> <ul style="list-style-type: none"> <li>• loudness <b>120 db</b></li> <li>• <b>toolless mounting</b></li> <li>• suitable for handlebars with Ø <b>22.2 - 31.8 mm</b></li> <li>• <b>waterproof</b></li> <li>• incl. battery (art. 640824)</li> <li>• in M-Wave blister packaging</li> <li>• 20 pcs in <b>M-Wave sales display</b></li> </ul> UVP 11,90 €	      

ART.-NR. 	BESCHREIBUNG	DESCRIPTION	
	<b>BALLHUPEN</b> • aus <b>verchromtem Stahl</b> • mit Befestigungsschelle für ca. Ø 22 mm Rohr	<b>AIR HORNS</b> • <b>chromium plated steel</b> • with rotary clip for approx. Ø 22 mm pipe	
<b>422001</b> 200/20	Einklang	one note	UVP 3,90 €
<b>422002</b> 100/10	Zweiklang	double note	UVP 6,90 €
<b>422003</b> 50	Dreiklang	triple note	UVP 9,90 €
<b>422008</b> 100	Posthorn	bugle air horn	UVP 6,90 €
<b>422009</b> 200/20	Fußball	soccer	UVP 4,90 €
	<b>MOTIV-HUPE</b>	<b>THEME CYCLE HORN</b>	
<b>422040</b>	Clownfisch	clown fish	
<b>422043</b>	Hund ›Pluto‹	dog ›Pluto‹	
<b>422044</b>	Krokodil	crocodile	
<b>422045</b>	Elefant	elephant	
<b>422046</b>	Schildkröte	tortoise	
<b>422047</b>	Tiger	tiger	
<b>422048</b> 100/10	Frosch	frog	
<b>420591</b> 80	<b>WINDRAD ›COLORWHEEL‹</b> • aus Kunststoff • <b>universelle Befestigung</b> am Lenker, Steuersatzrohr, ... durch Lenkerhalter Ø 22,2 - 26 mm und wiederverwendbaren Kabelbinder • auf Ventura Eurolochkarte	<b>WINDMILL ›COLORWHEEL‹</b> • made of plastic • <b>universal mounting</b> on handlebar, headtube, ... by handlebar bracket Ø 22.2 - 26 mm and reusable cable tie • on Ventura eurohole card	
			UVP 2,90 €





# SIDE STANDS













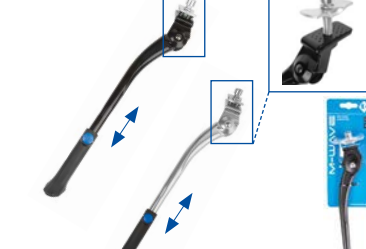

ART.-NR.	BESCHREIBUNG	DESCRIPTION	
<p><b>430794</b></p> <p><b>430795</b></p> <p>50</p>	<p><b>FAHRRADSTÄNDER</b></p> <ul style="list-style-type: none"> <li>• <b>Aluminium</b></li> <li>• für Hinterbau</li> <li>• <b>universell passend und einstellbar für fast alle Hinterbauwinkel, Rohrdurchmesser und Scheibenbremsenden</b></li> <li>• Länge werkzeuglos <b>verstellbar</b> für 24" - 29"</li> </ul> <p>schwarz</p> <p>silber</p>	<p><b>SIDE STAND</b></p> <ul style="list-style-type: none"> <li>• <b>aluminium</b></li> <li>• for rear stay</li> <li>• <b>universally suitable and adjustable for almost all rear stay angles, tube diameters and disc brake ends</b></li> <li>• length <b>adjustable</b> without tools for 24" - 29"</li> </ul> <p>black</p> <p>silver</p> <p>UVP 13,90 €</p>	
<p><b>430743</b></p> <p>50</p>	<p><b>FAHRRADSTÄNDER</b></p> <ul style="list-style-type: none"> <li>• zur Montage am Hinterbau</li> <li>• <b>Aluminium</b></li> <li>• Länge werkzeuglos <b>verstellbar</b> für 26" - 29"</li> <li>• <b>universell einstellbar für fast alle Hinterbauwinkel, Rohrdurchmesser und Scheibenbremsenden</b></li> </ul> <p>›STRONG R‹</p> <ul style="list-style-type: none"> <li>• <b>stabile</b> Ausführung für <b>E-Bikes</b>, ...</li> <li>• mit Sicherheitsfuß</li> </ul>	<p><b>SIDE STAND</b></p> <ul style="list-style-type: none"> <li>• for rear stay</li> <li>• <b>aluminium</b></li> <li>• length <b>adjustable</b> without tools for 26" - 29"</li> <li>• <b>universally adjustable for almost all rear stay angles, tube diameters and disc brake ends</b></li> </ul> <p>›STRONG R‹</p> <ul style="list-style-type: none"> <li>• <b>robust</b> design for <b>E-bikes</b>, ...</li> <li>• with safety foot</li> </ul> <p>UVP 10,90 €</p>	
<p><b>430745</b></p> <p><b>430744</b></p> <p>50</p>	<p>›STRONG R III‹ mit <b>Gummifuß</b></p> <p>Montageverpackung</p> <p>auf M-Wave Eurolochkarte</p>	<p>›STRONG R III‹ with <b>rubber foot</b></p> <p>OEM</p> <p>on M-Wave eurohole card</p> <p>UVP 13,90 €</p>	
<p><b>430755</b></p> <p><b>430758</b></p> <p>50</p>	<p><b>FAHRRADSTÄNDER</b></p> <ul style="list-style-type: none"> <li>• <b>Aluminium</b></li> <li>• für Hinterbau</li> <li>• Länge werkzeuglos <b>verstellbar</b> für 24" - 29"</li> </ul> <p>schwarz</p> <p>silber</p>	<p><b>SIDE STAND</b></p> <ul style="list-style-type: none"> <li>• <b>aluminium</b></li> <li>• for rear stay</li> <li>• length <b>adjustable</b> without tools for 24" - 29"</li> </ul> <p>black</p> <p>silver</p> <p>UVP 11,90 €</p>	
<p><b>430784</b></p> <p>50</p>	<p><b>PARKSTÜTZE</b></p> <ul style="list-style-type: none"> <li>• <b>Aluminium</b>, schwarz</li> <li>• für Hinterbaubefestigung</li> <li>• Länge <b>verstellbar</b> für 24" - 28"</li> </ul>	<p><b>SIDE STAND</b></p> <ul style="list-style-type: none"> <li>• <b>aluminium</b>, black</li> <li>• for rear stay</li> <li>• length <b>adjustable</b> for 24" - 28"</li> </ul> <p>UVP 7,90 €</p>	

ART.-NR.	BESCHREIBUNG	DESCRIPTION	
<p><b>FAHRRADSTÄNDER</b></p> <ul style="list-style-type: none"> <li>Aluminium</li> <li>extra robuste Ausführung</li> <li>verstellbar von 24" - 29"</li> <li>besonders für E-Bikes geeignet</li> <li>mit stabilem Sicherheitsfuß</li> <li>inkl. Montagematerial</li> <li>für Montage an der Kettenstrebe</li> </ul> <p>›COLUMN-E2‹</p> <ul style="list-style-type: none"> <li>universell passend für Lochabstand 40 mm und 18 mm</li> <li>mit 2x M6 Niro-Befestigungsschrauben</li> </ul> <p><b>430849</b> Montageverpackung</p> <p><b>430850</b> auf M-Wave Eurolochkarte</p> <p>40</p>	<p><b>FAHRRADSTÄNDER</b></p> <ul style="list-style-type: none"> <li>Aluminium</li> <li>extra robuste Ausführung</li> <li>verstellbar von 24" - 29"</li> <li>besonders für E-Bikes geeignet</li> <li>mit stabilem Sicherheitsfuß</li> <li>inkl. Montagematerial</li> <li>für Montage an der Kettenstrebe</li> </ul> <p>›COLUMN-E2‹</p> <ul style="list-style-type: none"> <li>universell passend für Lochabstand 40 mm und 18 mm</li> <li>mit 2x M6 Niro-Befestigungsschrauben</li> </ul> <p><b>430849</b> Montageverpackung</p> <p><b>430850</b> auf M-Wave Eurolochkarte</p> <p>40</p>	<p><b>SIDE STAND</b></p> <ul style="list-style-type: none"> <li>aluminium</li> <li>extra robust design</li> <li>adjustable from 24" - 29"</li> <li>especially suitable for e-bikes</li> <li>with stable safety foot</li> <li>incl. mounting material</li> <li>for assembling at the chain stay</li> </ul> <p>›COLUMN-E2‹</p> <ul style="list-style-type: none"> <li>universally suitable for hole distance 40 mm and 18 mm</li> <li>with 2x M6 stainless steel mounting screws</li> </ul> <p>OEM</p> <p>on M-Wave eurohole card</p> <p>UVP 18,90 €</p>	
<p>›COLUMN-E1‹</p> <ul style="list-style-type: none"> <li>passend für Lochabstand 18 mm</li> <li>mit Verdrehschutz-Nut</li> <li>mit 2x M6 Niro-Befestigungsschrauben und Muttern</li> </ul> <p><b>430853</b> Montageverpackung</p> <p><b>430854</b> auf M-Wave Eurolochkarte</p> <p>40</p>	<p>›COLUMN-E1‹</p> <ul style="list-style-type: none"> <li>passend für Lochabstand 18 mm</li> <li>mit Verdrehschutz-Nut</li> <li>mit 2x M6 Niro-Befestigungsschrauben und Muttern</li> </ul> <p><b>430853</b> Montageverpackung</p> <p><b>430854</b> auf M-Wave Eurolochkarte</p> <p>40</p>	<p>›COLUMN-E1‹</p> <ul style="list-style-type: none"> <li>suitable for hole distance 18 mm</li> <li>anti-rotation slot</li> <li>with 2x M6 stainless steel mounting screws and nuts</li> </ul> <p>OEM</p> <p>on M-Wave eurohole card</p> <p>UVP 17,90 €</p>	
<p>• <b>430925</b> <b>FAHRRADSTÄNDER</b></p> <p>40</p> <ul style="list-style-type: none"> <li>stabile Ausführung für E-Bikes, ...</li> <li>zur Montage an der Kettenstrebe, universell passend für Lochabstand 40 und 18 mm</li> <li>mit 2x M6 Nirosta Beilagscheiben und Muttern</li> <li>Aluminium</li> <li>werkzeuglos verstellbar</li> <li>für 24" - 29"</li> <li>mit Sicherheitsfuß</li> <li>inkl. Montagematerial</li> <li>Montageverpackung</li> </ul>	<p>• <b>430925</b> <b>FAHRRADSTÄNDER</b></p> <p>40</p> <ul style="list-style-type: none"> <li>stabile Ausführung für E-Bikes, ...</li> <li>zur Montage an der Kettenstrebe, universell passend für Lochabstand 40 und 18 mm</li> <li>mit 2x M6 Nirosta Beilagscheiben und Muttern</li> <li>Aluminium</li> <li>werkzeuglos verstellbar</li> <li>für 24" - 29"</li> <li>mit Sicherheitsfuß</li> <li>inkl. Montagematerial</li> <li>Montageverpackung</li> </ul>	<p><b>SIDE STAND</b></p> <ul style="list-style-type: none"> <li>robust design for e-bikes, ...</li> <li>for mounting at the chain stay, universally suitable for hole distance 40 and 18 mm</li> <li>with 2x M6 stainless steel washers and nuts</li> <li>aluminium</li> <li>adjustable without tools</li> <li>for 24" - 29"</li> <li>with safety foot</li> <li>incl. mounting material</li> <li>OEM</li> </ul> <p>UVP 14,90 €</p>	
<p><b>430845</b> <b>FAHRRADSTÄNDER</b></p> <p>50</p> <ul style="list-style-type: none"> <li>Aluminium</li> <li>Befestigung direkt an der Kettenstrebe</li> <li>Länge werkzeuglos verstellbar für 24" - 29"</li> </ul>	<p><b>430845</b> <b>FAHRRADSTÄNDER</b></p> <p>50</p> <ul style="list-style-type: none"> <li>Aluminium</li> <li>Befestigung direkt an der Kettenstrebe</li> <li>Länge werkzeuglos verstellbar für 24" - 29"</li> </ul>	<p><b>SIDE STAND</b></p> <ul style="list-style-type: none"> <li>aluminium</li> <li>mounting directly at the chain stay</li> <li>length adjustable without tools for 24" - 29"</li> </ul> <p>UVP 11,90 €</p>	
<p><b>430848</b> <b>FAHRRADSTÄNDER</b></p> <p>50</p> <ul style="list-style-type: none"> <li>zur Montage an der Kettenstrebe, universell passend für Lochabstand 40 und 18 mm</li> <li>mit Nirosta-Schrauben</li> <li>Aluminium</li> <li>Länge werkzeuglos verstellbar für 24" - 29"</li> <li>mit Sicherheitsfuß</li> <li>inkl. Montagematerial</li> </ul>	<p><b>430848</b> <b>FAHRRADSTÄNDER</b></p> <p>50</p> <ul style="list-style-type: none"> <li>zur Montage an der Kettenstrebe, universell passend für Lochabstand 40 und 18 mm</li> <li>mit Nirosta-Schrauben</li> <li>Aluminium</li> <li>Länge werkzeuglos verstellbar für 24" - 29"</li> <li>mit Sicherheitsfuß</li> <li>inkl. Montagematerial</li> </ul>	<p><b>SIDE STAND</b></p> <ul style="list-style-type: none"> <li>for mounting at the chain stay, universally suitable for hole distance 40 and 18 mm</li> <li>with stainless steel screws</li> <li>aluminium</li> <li>length adjustable without tools for 24" - 29"</li> <li>with safety foot</li> <li>incl. mounting material</li> </ul> <p>UVP 12,90 €</p>	

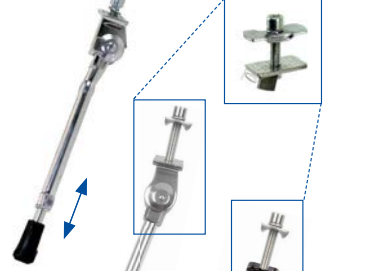

ART.-NR.	BESCHREIBUNG	DESCRIPTION	
	<b>FAHRRADSTÄNDER</b> <ul style="list-style-type: none"> <li>• <b>Aluminium</b></li> <li>• Befestigung an der <b>Kettenstrebe</b></li> <li>• geeignet für Rahmen mit <b>kleinem Winkel</b> zwischen Sitzrohr- und Kettenstrebe (z. B. bei <b>gedeferten Rahmen</b>)</li> <li>• mit <b>Ausgleichsadapter</b> für verschiedene Kettenstrebenformen</li> </ul>	<b>SIDE STAND</b> <ul style="list-style-type: none"> <li>• <b>aluminium</b></li> <li>• mounting at the <b>chain stay</b></li> <li>• suitable for frames with <b>small angle</b> between seat stay and chain stay (e. g. at <b>suspension frames</b>)</li> <li>• with <b>compensation adapter</b> for different chain stay forms</li> </ul>	
<b>430710</b> 50	Länge werkzeuglos <b>verstellbar</b> für 24" - 29"	length <b>adjustable</b> without tools for 24" - 29" UVP 14,90 €	
<b>430720</b> 30	<ul style="list-style-type: none"> <li>• <b>einfache</b> werkzeuglose <b>Höhenverstellung</b> durch Druckknopf, 26" - 29"</li> <li>• mit <b>Nirosta</b>-Schrauben</li> </ul>	<ul style="list-style-type: none"> <li>• <b>easy height adjustment</b> without tools by push button, 26" - 29"</li> <li>• with <b>stainless steel</b> screws</li> </ul> UVP 9,90 €	
<b>430719</b> 50	<b>Modell ECO</b> , verstellbar für 20" - 29"	<b>model ECO</b> , adjustable for 20" - 29" UVP 5,90 €	
<b>430706</b> 50	<b>FAHRRADSTÄNDER ›STRONG F‹</b> <ul style="list-style-type: none"> <li>• <b>Aluminium</b></li> <li>• <b>stufenlos verstellbar</b></li> <li>• <b>extra robuste</b> Ausführung</li> <li>• für Montage in der Mitte (hinter dem Tretlagergehäuse)</li> <li>• mit Gegenplatte</li> <li>• mit <b>stabilem Sicherheitsfuß</b></li> <li>• passend für <b>24" - 29"</b></li> <li>• Montageverpackung</li> </ul>	<b>SIDE STAND ›STRONG F‹</b> <ul style="list-style-type: none"> <li>• <b>aluminium</b></li> <li>• <b>steplessly adjustable</b></li> <li>• <b>extra robust</b> design</li> <li>• for assembling behind the B.B. tube (between the chain stays)</li> <li>• with counter plate</li> <li>• with <b>robust safety foot</b></li> <li>• suitable for <b>24" - 29"</b></li> <li>• OEM</li> </ul> UVP 25,90 €	
<b>430734</b> 40	Montageverpackung	OEM	
<b>430736</b> 50	auf M-Wave Eurolochkarte	on M-Wave eurohole card UVP 12,90 €	
<b>430724</b> 50	<b>FAHRRADSTÄNDER</b> <ul style="list-style-type: none"> <li>• <b>Aluminium</b></li> <li>• <b>verstellbar</b> von 24" - 28"</li> <li>• robuste Ausführung</li> <li>• mit <b>Sicherheitsfuß</b></li> <li>• für Montage in der Mitte (hinter dem Tretlagergehäuse)</li> <li>• ohne Gegenplatte</li> <li>• Montageverpackung</li> </ul>	<b>SIDE STAND</b> <ul style="list-style-type: none"> <li>• <b>aluminium</b></li> <li>• <b>adjustable</b> from 24" - 28"</li> <li>• robust design</li> <li>• with <b>safety foot</b></li> <li>• for assembling behind the B.B. tube (between the chain stays)</li> <li>• without counter plate</li> <li>• OEM</li> </ul> UVP 8,90 €	





ART.-NR.	BESCHREIBUNG	DESCRIPTION	
 <ul style="list-style-type: none"> <li>• <b>430852</b> Montageverpackung 50</li> <li>• <b>430851</b> auf M-Wave Eurolochkarte 30</li> </ul>	<p><b>FAHRRADSTÄNDER</b></p> <ul style="list-style-type: none"> <li>• <b>Aluminium</b></li> <li>• für Montage in der Mitte (hinter dem Tretlagergehäuse)</li> <li>• <b>stufenlos verstellbar</b></li> <li>• mit Sicherheitsfuß</li> <li>• mit <b>Edelstahlstreben</b></li> <li>• passend für <b>24" - 29"</b></li> </ul>	<p><b>SIDE STAND</b></p> <ul style="list-style-type: none"> <li>• <b>aluminium</b></li> <li>• for assembling behind the B.B.-tube (between the chain stays)</li> <li>• <b>steplessly adjustable</b></li> <li>• with safety foot</li> <li>• with <b>stainless steel rails</b></li> <li>• suitable for <b>24" - 29"</b></li> </ul> <p>OEM</p> <p>on M-Wave eurohole card</p> <p style="text-align: right;">UVP 7,90 €</p>	 <p><b>STAINLESS</b></p> 
<ul style="list-style-type: none"> <li>• <b>430717</b> schwarz, Montageverpackung 50</li> <li>• <b>430718</b> silber, Montageverpackung 50</li> </ul>	<p><b>FAHRRADSTÄNDER</b></p> <ul style="list-style-type: none"> <li>• <b>Aluminium</b></li> <li>• für Montage in der Mitte (hinter dem Tretlagergehäuse)</li> <li>• <b>werkzeuglos verstellbar</b></li> <li>• mit Sicherheitsfuß</li> <li>• passend für <b>24" - 29"</b></li> </ul>	<p><b>SIDE STAND</b></p> <ul style="list-style-type: none"> <li>• <b>aluminium</b></li> <li>• for assembling behind the B.B.-tube (between the chain stays)</li> <li>• <b>adjustable without tools</b></li> <li>• with safety foot</li> <li>• suitable for <b>24" - 29"</b></li> </ul> <p>black, OEM</p> <p>silver, OEM</p> <p style="text-align: right;">UVP 6,90 €</p>	 
<ul style="list-style-type: none"> <li>• <b>430715</b> schwarz, Montageverpackung 50</li> <li>• <b>430716</b> silber, Montageverpackung 50</li> <li>• <b>430714</b> schwarz, auf M-Wave Eurolochkarte 30</li> </ul>	<p>mit Gegenplatte</p>	<p>with counter plate</p> <p>black, OEM</p> <p>silver, OEM</p> <p>black, on M-Wave eurohole card</p> <p style="text-align: right;">UVP 7,90 €</p>	 
<ul style="list-style-type: none"> <li>• <b>430713</b> Montageverpackung 50</li> <li>• <b>430712</b> auf M-Wave Eurolochkarte 30</li> </ul>	<ul style="list-style-type: none"> <li>• mit Gegenplatte</li> <li>• passend für <b>16" - 20"</b></li> <li>• schwarz</li> </ul>	<ul style="list-style-type: none"> <li>• with counter plate</li> <li>• suitable for <b>16" - 20"</b></li> <li>• black</li> </ul> <p>OEM</p> <p>on M-Wave eurohole card</p> <p style="text-align: right;">UVP 6,90 €</p>	<p><b>16" - 20"</b></p>  
<ul style="list-style-type: none"> <li>• <b>430822</b> Montageverpackung 50</li> </ul>	<p><b>FAHRRADSTÄNDER</b></p> <ul style="list-style-type: none"> <li>• <b>Aluminium</b></li> <li>• für Montage in der Mitte (hinter dem Tretlagergehäuse)</li> <li>• mit Innensechskantschraube</li> <li>• <b>verstellbar</b></li> <li>• mit <b>Sicherheitsfuß</b> (Art. 430832)</li> <li>• passend für Radgrößen <b>20" - 29"</b></li> </ul>	<p><b>SIDE STAND</b></p> <ul style="list-style-type: none"> <li>• <b>aluminium</b></li> <li>• for assembling behind the B.B.-tube (between the chain stays)</li> <li>• with allen screw</li> <li>• <b>adjustable</b></li> <li>• with <b>safety foot</b> (art. 430832)</li> <li>• suitable for wheel sizes <b>20" - 29"</b></li> </ul> <p style="text-align: right;">UVP 4,50 €</p>	 
<ul style="list-style-type: none"> <li>• <b>430835</b> Montageverpackung 50</li> <li>• <b>430830</b> auf M-Wave Eurolochkarte 50</li> </ul>	<p>wie Art. 430822, mit Innensechskantschraube und <b>Gegenplatte</b></p> <ul style="list-style-type: none"> <li>• <b>20" - 29"</b></li> <li>• silber</li> </ul>	<p>like art. 430822, with allen screw and <b>counter plate</b></p> <ul style="list-style-type: none"> <li>• <b>20" - 29"</b></li> <li>• silver</li> </ul>	 <p><b>12" - 20"</b></p> 
<ul style="list-style-type: none"> <li>• <b>430840</b> Montageverpackung 50</li> </ul>	<ul style="list-style-type: none"> <li>• <b>12" - 20"</b></li> <li>• silber</li> </ul>	<ul style="list-style-type: none"> <li>• <b>12" - 20"</b></li> <li>• silver</li> </ul> <p style="text-align: right;">UVP 4,90 €</p>	 









# FAHRRADSTÄNDER SIDE STANDS

ART.-NR. 	BESCHREIBUNG	DESCRIPTION	
	<p><b>FAHRRADSTÄNDER</b></p> <ul style="list-style-type: none"> <li>• <b>Aluminium</b></li> <li>• für Montage in der Mitte (hinter dem Tretlagergehäuse)</li> <li>• mit <b>Sicherheitsfuß</b></li> <li>• mit <b>Längenskala</b></li> <li>• auf <b>gewünschte Länge kürzbar</b></li> <li>• somit universell einsetzbar von <b>12" - 29"</b></li> </ul>	<p><b>SIDE STAND</b></p> <ul style="list-style-type: none"> <li>• <b>aluminium</b></li> <li>• for assembling behind the B.B.-tube (between the chain stays)</li> <li>• with <b>safety foot</b></li> <li>• with <b>scale for lengths</b></li> <li>• <b>can be shortened to the required length</b></li> <li>• therefore universally adjustable of <b>12" - 29"</b></li> </ul>	
430829	schwarz	black	
430828 50	silber	silver	UVP 4,90 €
430831 500/50	Ersatz-Sicherheitsfuß	replacement safety foot	UVP 0,90 €
430256 50	<p><b>FAHRRADSTÄNDER</b></p> <ul style="list-style-type: none"> <li>• <b>stabile</b> Ausführung</li> <li>• zur Montage an der <b>Nabenachse</b></li> <li>• mit Verkratzschutz-Einlagen</li> <li>• aus <b>Aluminium/Stahl</b></li> <li>• Länge <b>werkzeuglos verstellbar</b> für 26" - 29"</li> <li>• mit Sicherheitsfuß</li> </ul>	<p><b>SIDE STAND</b></p> <ul style="list-style-type: none"> <li>• <b>robust</b> design</li> <li>• for mounting at the <b>hub axle</b></li> <li>• with anti-scratch inlays</li> <li>• <b>aluminium/steel</b></li> <li>• length <b>adjustable without tools</b> for 26" - 29"</li> <li>• with safety foot</li> </ul>	
430257	<p><b>FAHRRADSTÄNDER</b></p> <ul style="list-style-type: none"> <li>• Stahl</li> <li>• schwarz</li> <li>• für 26"(+ 28")</li> <li>• zur Montage an der <b>Nabenachse</b></li> <li>• universell passend für <b>Festachse</b> und <b>Schnellspanner</b></li> </ul>	<p><b>SIDE STAND</b></p> <ul style="list-style-type: none"> <li>• steel</li> <li>• black</li> <li>• for 26"(+ 28")</li> <li>• for mounting at the <b>hub axle</b></li> <li>• universally suitable for <b>solid axle</b> and <b>quick release</b></li> </ul>	UVP 8,90 €
430257 50			UVP 3,90 €
430809 200 set	<p><b>SCHRAUBE UND GEGENPLATTE FÜR FAHRRADSTÄNDER</b></p> <ul style="list-style-type: none"> <li>• 60 mm Schraube (M10 x 50 mm Gewinde)</li> <li>• verzinkt</li> <li>• Set im Polybeutel</li> </ul>	<p><b>BOLT AND COUNTER PLATE FOR SIDE STANDS</b></p> <ul style="list-style-type: none"> <li>• 60 mm screw (M10 x 50 mm thread)</li> <li>• zinc plated</li> <li>• set in PE bag</li> </ul>	
			UVP 0,90 €

# ZWEIBEIN-FAHRRADSTÄNDER DOUBLE LEG SIDE STANDS

ART.-NR.	BESCHREIBUNG	DESCRIPTION	
<b>430960</b> 20	<b>ZWEIBEIN-FAHRRADSTÄNDER ›HEAVY DUTY‹</b> <ul style="list-style-type: none"> <li>das Bein auf der <b>Kettenseite klappt</b> auf die andere Seite: dadurch kein <b>Platzproblem</b> auf der Kettenseite</li> <li><b>Aluminium</b></li> <li>für Montage in der Mitte (hinter dem Tretlagergehäuse)</li> <li><b>verstellbar</b> von <b>24" - 29"</b></li> <li>mit Sicherheitsfüßen</li> <li>inkl. Befestigungsschrauben und <b>Aluminium</b>gegenplatte</li> <li>Montageverpackung</li> </ul>	<b>DOUBLE LEG STAND ›HEAVY DUTY‹</b> <ul style="list-style-type: none"> <li>the leg on the <b>chain side folds</b> to the other side: thus there is no <b>space problem</b> on the chain side</li> <li><b>aluminium</b></li> <li>for mounting behind the B.B.-tube (between the chain stays)</li> <li><b>adjustable</b> from <b>24" - 29"</b></li> <li>with safety feet</li> <li>incl. mounting screws and <b>aluminium</b> counter plate</li> <li>OEM</li> </ul> <p style="text-align: right;">UVP 45,90 €</p>	
<b>430778</b> 20	<b>ZWEIBEIN-FAHRRADSTÄNDER</b> <ul style="list-style-type: none"> <li><b>Aluminium</b></li> <li><b>verstellbar</b> von 24" - 28"</li> <li><b>Füße falten</b> sich beim Hochklappen zusammen</li> <li>Abstand zum Tretlagergehäuse verstellbar</li> <li>nur 619 g</li> <li>innenliegende Feder ist vor Schmutz und Wasser geschützt</li> <li>mit stabilen <b>Sicherheitsfüßen</b></li> <li>Montageverpackung</li> </ul>	<b>DOUBLE LEG STAND</b> <ul style="list-style-type: none"> <li><b>aluminium</b></li> <li><b>adjustable</b> from 24" - 28"</li> <li><b>feet fold together</b> during retracting</li> <li>distance to the bottom bracket housing adjustable</li> <li>only 619 g</li> <li>spring inside protected from dirt and water</li> <li>with firm <b>safety feet</b></li> <li>OEM</li> </ul> <p style="text-align: right;">UVP 33,90 €</p>	
<b>430770</b> 20	<b>ZWEIBEIN-FAHRRADSTÄNDER</b> <ul style="list-style-type: none"> <li><b>Aluminium</b></li> <li>mit <b>Aluminium</b>gegenplatte</li> <li>nur <b>528 g</b></li> <li>mit Anti-Rutsch-Füßen</li> <li><b>werkzeuglos</b> verstellbar von <b>24" - 28"</b></li> <li>mit Feinabstufung</li> <li><b>innenliegende</b> Feder</li> <li>Montageverpackung</li> </ul>	<b>DOUBLE LEG STAND</b> <ul style="list-style-type: none"> <li><b>aluminium</b></li> <li>with <b>aluminium</b> counter plate</li> <li>only <b>528 g</b></li> <li>with anti slide feet</li> <li>adjustable <b>without tools</b> from <b>24" - 28"</b></li> <li>with micro adjustment</li> <li>with spring <b>inside</b></li> <li>OEM</li> </ul> <p style="text-align: right;">UVP 16,90 €</p>	
<b>430771</b> 20	<ul style="list-style-type: none"> <li><b>Aluminium / Stahl</b></li> <li>26" - 28"</li> </ul>	<ul style="list-style-type: none"> <li><b>aluminium / steel</b></li> <li>26" - 28"</li> </ul> <p style="text-align: right;">UVP 12,90 €</p>	
<b>430772</b> 20	<ul style="list-style-type: none"> <li>Stahl / Stahl</li> <li>mit Stahlplatte</li> <li>26" - 28"</li> </ul>	<ul style="list-style-type: none"> <li>steel / steel</li> <li>with steel plate</li> <li>26" - 28"</li> </ul> <p style="text-align: right;">UVP 13,90 €</p>	
<b>430773</b> 400	Ersatz-Sicherheitsfuß für Art. 430772, ...	replacement safety foot for art. 430772, ...	

# LENKUNGSDÄMPFER, FAHRRADHALTER STEERING DAMPER, BICYCLE STAND

ART.-NR.	BESCHREIBUNG	DESCRIPTION	
	<p><b>LENKUNGSDÄMPFER</b></p> <ul style="list-style-type: none"> <li>• besonders geeignet für Fahrräder mit 2-Bein-Ständer: verhindert unkontrolliertes Herumschlagen des Vorderrades</li> <li>• im Polybeutel</li> </ul>	<p><b>STEERING DAMPER</b></p> <ul style="list-style-type: none"> <li>• especially suitable for bicycles with 2-leg stands: prevents uncontrolled swinging of the front wheel</li> <li>• in PE bag</li> </ul>	
<p><b>430900</b> 300</p>	<p>inkl. Adapter für Rohrdurchmesser <b>28,6 - 31,8 mm</b></p>	<p>with adapters for tube diameter <b>28.6 - 31.8 mm</b></p>	
<p><b>430901</b> 200</p>	<p><b>universell</b> passend für <b>Oversize-Rohre</b> bis <b>Ø 63 mm, Universal-Rohrschelle</b></p>	<p><b>universally fitting for oversize tubes</b> up to <b>Ø 63 mm, zip type</b></p>	
<p><b>430902</b> 150</p>	<ul style="list-style-type: none"> <li>• <b>Konus</b>-Befestigung von unten im <b>Gabelschaft</b> (für Federgabeln, ...)</li> <li>• inkl. Adapter für <b>1" und 1 1/8"</b> Gabelschäfte</li> <li>• universelle Befestigungsschelle für Rohrdurchmesser bis <b>Ø 63 mm</b></li> </ul>	<ul style="list-style-type: none"> <li>• <b>cone mounting from bottom into fork shaft</b> (for suspension forks, ...)</li> <li>• incl. adapter for <b>1" and 1 1/8"</b> fork shafts</li> <li>• universal mounting clamp for tubes up to <b>Ø 63 mm</b></li> </ul>	
<p><b>430270</b> 2</p>	<p><b>AUSZIEHBARE FAHRRADDISPLAYSTANGE</b></p> <ul style="list-style-type: none"> <li>• aus <b>Aluminium</b></li> <li>• <b>variable Aufbauhöhe</b> von 205 - 375 cm</li> <li>• <b>stufenlos verstellbar</b> mit Schnellspanner und Spannrad</li> <li>• inkl. 2 <b>stufenlos höhenverstellbaren Haltebügel</b> mit je 2 Haken</li> <li>• Hakenabstand verschiebbar, ca. 13 - 37 cm</li> <li>• ca. 70° <b>seitlich schwenkbar</b></li> <li>• durch zusätzliche Haltebügel für bis zu <b>6 Fahrräder</b></li> </ul>	<p><b>TELESCOPIC BICYCLE DISPLAY</b></p> <ul style="list-style-type: none"> <li>• made of <b>aluminium</b></li> <li>• <b>variable presentation height</b> from 205 - 375 cm</li> <li>• <b>steplessly adjustable</b> by QRs and tension wheel</li> <li>• incl. 2 <b>steplessly adjustable display racks</b> with two hooks each</li> <li>• adjustable hook distance, approx. 13 - 37 cm</li> <li>• approx. 70° <b>rotatable</b></li> <li>• fixes up to <b>6 bicycles</b> by additional display racks</li> </ul>	<p><b>1-6 BICYCLES</b></p>  <p>13 - 37 cm</p> <p>70°</p> <p>205 - 375 cm</p>
<p><b>430271</b></p>	<p>Halteklammer, Ø 40 mm (oben)</p>	<p>clamp, Ø 40 mm (top)</p>	
<p><b>430272</b></p>	<p>Halteklammer, Ø 45 mm (unten)</p>	<p>clamp, Ø 45 mm (down)</p>	
<p><b>430273</b> 20</p>	<p>Haltebügel mit zwei Haken</p>	<p>bicycle display rack with two hooks</p>	



ART.-NR.	BESCHREIBUNG	DESCRIPTION	
<b>430217</b> 5	<b>FAHRRAD-WANDHALTER ›COLLECTOR‹</b> <ul style="list-style-type: none"> <li>• zugelassen auch für <b>E-Bikes</b> bis <b>40 kg</b></li> <li>• für Fahrräder, Fahrradträger, Ski, ...</li> <li>• mit <b>Helm-, ... -ablage</b></li> <li>• besonders <b>stabil</b> und <b>belastbar</b></li> <li>• 2 Haltebügel mit Kunststoff-<b>Schutzüberzug</b></li> <li>• <b>hochklappbar</b></li> <li>• mit Befestigungsschrauben und Dübeln</li> <li>• mit M-Wave Eurolochkarte</li> </ul>	<b>BICYCLE DEPOT WALL HANGER ›COLLECTOR‹</b> <ul style="list-style-type: none"> <li>• also approved for <b>e-bikes</b> up to <b>40 kg</b></li> <li>• for bikes, bike carriers, ski, ...</li> <li>• with <b>helmet, ... depot</b></li> <li>• very <b>solid</b> and <b>loadable</b></li> <li>• two arms with plastic <b>protection cover</b></li> <li>• <b>foldable</b></li> <li>• with screws and plugs</li> <li>• with M-Wave eurohole card</li> </ul>	<div style="text-align: right;"> </div> <div style="text-align: center;"> <b>E-BIKE / 40 KG APPROVED</b> </div> <div style="text-align: right;"> </div>
<b>430215</b> 8	<b>FAHRRAD-WANDHALTER ›COLLECTOR HD‹</b> <ul style="list-style-type: none"> <li>• stabiler Wandhalter</li> <li>• <b>zugelassen für bis zu 2 E-Bikes</b> mit insgesamt bis zu <b>70 kg</b></li> <li>• Haltebügel mit Kunststoffschutzüberzug</li> <li>• für Fahrräder, Fahrradträger, Ski, ...</li> <li>• mit Helm-, ... -Ablage</li> <li>• <b>hochklappbar</b></li> <li>• inkl. Montagematerial</li> <li>• mit M-Wave Banderole</li> </ul>	<b>BICYCLE DEPOT WALL HANGER ›COLLECTOR HD‹</b> <ul style="list-style-type: none"> <li>• stable wall hanger</li> <li>• <b>approved for up to 2 e-bikes</b> with a total of up to <b>70 kg</b></li> <li>• hooks with plastic protection cover</li> <li>• for bikes, bike carriers, ski, ...</li> <li>• with helmet, ... depot</li> <li>• <b>foldable</b></li> <li>• incl. mounting material</li> <li>• with M-Wave banderole</li> </ul>	<div style="text-align: right;"> </div> <div style="text-align: center;"> <b>E-BIKE / 70 KG APPROVED</b> </div> <div style="text-align: right;"> </div> <div style="text-align: center;"> <b>VERKRATZSCHUTZ/ SCRATCH PROTECTION</b> </div>
<b>430210</b> 12	<b>FAHRRAD-WANDHALTER</b> <ul style="list-style-type: none"> <li>• Haltebügel mit <b>Gummischutzüberzug</b></li> <li>• <b>hochklappbar</b></li> <li>• mit Befestigungsschrauben und Dübeln</li> <li>• <b>zerlegbar</b></li> <li>• auf Ventura Eurolochkarte</li> </ul>	<b>BICYCLE DEPOT WALL HANGER</b> <ul style="list-style-type: none"> <li>• hooks with <b>rubber protection cover</b></li> <li>• <b>foldable</b></li> <li>• with screws and plugs</li> <li>• <b>demountable</b></li> <li>• on Ventura eurohole card</li> </ul>	<div style="text-align: right;"> </div> <div style="text-align: right;"> </div> <div style="text-align: center;"> <b>VERKRATZSCHUTZ/ SCRATCH PROTECTION</b> </div>
<b>430212</b> 24	<b>FAHRRAD-WANDHALTER</b> <ul style="list-style-type: none"> <li>• stabiler Wandhalter zum <b>Einhängen</b> des Fahrrads <b>am Pedal</b></li> <li>• für nahezu <b>alle Rahmenformen und -größen geeignet</b></li> <li>• mit <b>Schutzüberzug</b></li> <li>• mit zusätzlicher <b>Lafradabstützung</b></li> <li>• mit Befestigungsschrauben und Dübeln</li> <li>• im Polybeutel mit Ventura Eurolochkarte</li> </ul>	<b>BICYCLE DEPOT WALL HANGER</b> <ul style="list-style-type: none"> <li>• stable wall hanger to <b>hang up</b> the bicycle <b>using the pedal</b></li> <li>• for almost <b>every frame shapes and sizes</b></li> <li>• with <b>protection cover</b></li> <li>• with additional <b>wheelset support</b></li> <li>• with fitting screws and plugs</li> <li>• PE bag with Ventura eurohole card</li> </ul>	<div style="text-align: right;"> </div> <div style="text-align: center;"> <b>VERKRATZSCHUTZ/ SCRATCH PROTECTION</b> </div> <div style="text-align: right;"> </div>
<b>430260</b> 20	<b>FAHRRAD-WANDHALTER</b> <ul style="list-style-type: none"> <li>• <b>sehr stabiler</b> Wandhalter</li> <li>• mit <b>Schutzüberzug</b></li> <li>• mit Befestigungsschrauben und Dübeln</li> <li>• auf Ventura Eurolochkarte</li> </ul>	<b>BICYCLE DEPOT WALL HANGER</b> <ul style="list-style-type: none"> <li>• <b>very stable</b> wall hanger</li> <li>• with <b>protection cover</b></li> <li>• with fitting screws and plugs</li> <li>• on Ventura eurohole card</li> </ul>	<div style="text-align: right;"> </div> <div style="text-align: center;"> <b>VERKRATZSCHUTZ/ SCRATCH PROTECTION</b> </div> <div style="text-align: right;"> </div>

ART.-NR.	BESCHREIBUNG	DESCRIPTION	
 <b>430235</b> 10 <b>430230</b> 5	<b>FAHRRADHALTER ›SUPERSTAND‹</b> <ul style="list-style-type: none"> <li>• für <b>Fahrräder aller Größen 12" - 29"</b></li> <li>• Reifenbreite bis <b>2,50"</b></li> <li>• kein Anheben des Rades notwendig, <b>einfach hinein-/herausrollen</b></li> <li>• aus stabilem Rundrohr</li> <li>• <b>Non-Slip</b> Füße</li> <li>• silber</li> <li>• H = 75 cm x B = 40 cm x L = 42 cm</li> </ul> im Superstand Einzelkarton  Montageverpackung	<b>BICYCLE STAND ›SUPERSTAND‹</b> <ul style="list-style-type: none"> <li>• for <b>bicycles of all sizes 12" - 29"</b></li> <li>• tire width up to <b>2.50"</b></li> <li>• no lifting of the bike necessary, <b>just roll in and out</b></li> <li>• made of solid round tubes</li> <li>• <b>non-slip</b> feet</li> <li>• silver</li> <li>• H = 75 cm x W = 40 cm x L = 42 cm</li> </ul> in Superstand box  OEM  UVP 42,90 €	
<b>430241</b> 10 <b>430239</b> 5 <b>430238</b> 10	für <b>FAT / SNOW- UND PLUS-BIKES</b>  <b>›Extreme‹</b> ideal für <b>2,50"</b> bis <b>3,25"</b> Reifenbreite  im Superstand Einzelkarton  Montageverpackung  <b>›Fat Rack‹</b> <ul style="list-style-type: none"> <li>• ideal für <b>2,75" - 5,25"</b> Reifenbreite</li> <li>• <b>Innenweite verstellbar (110 - 135 mm)</b></li> <li>• im Superstand Einzelkarton</li> </ul>	for <b>FAT / SNOW AND PLUS BIKES</b>  <b>›Extreme‹</b> ideal for <b>2.50"</b> up to <b>3.25"</b> tire width  in Superstand box  OEM  UVP 43,90 €  <b>›Fat Rack‹</b> <ul style="list-style-type: none"> <li>• ideal for <b>2.75" - 5.25"</b> tire width</li> <li>• <b>adjustable inner width (110 - 135 mm)</b></li> <li>• in Superstand box</li> </ul> UVP 45,90 €	
<b>430236</b> 100 set	<b>HÖHENERWEITERUNG</b> <ul style="list-style-type: none"> <li>• Nachrüstset für <b>besonders große Laufräder</b></li> <li>• <b>Verlängerung</b> einfach ins bestehende Superstand-System einklicken</li> <li>• im Polybeutel mit Eurolochkarte</li> </ul>	<b>HEIGHT EXTENSION</b> <ul style="list-style-type: none"> <li>• extension set for <b>especially big wheels</b></li> <li>• <b>extension</b> to be mounted into your existing Superstand system</li> <li>• in PE bag with eurohole card</li> </ul> UVP 4,90 €	

# TRAUM JOB FAHRRAD









**messingschlag**  
THE BIKE EXPERIENCE

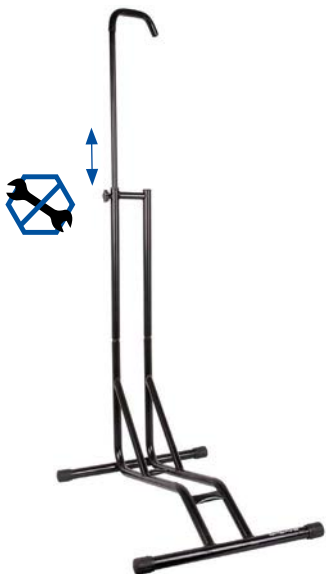





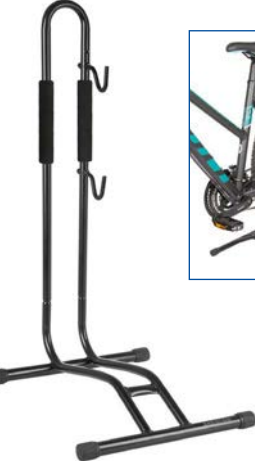





[www.messingschlag.com](http://www.messingschlag.com)



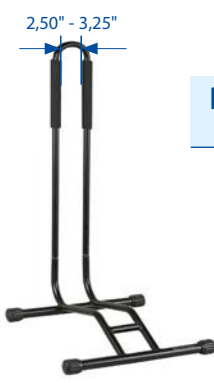

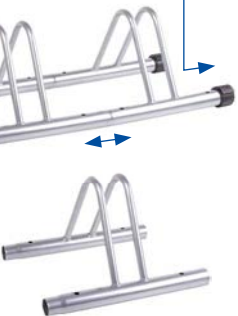







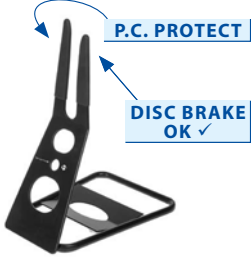

#TraumjobFahrrad

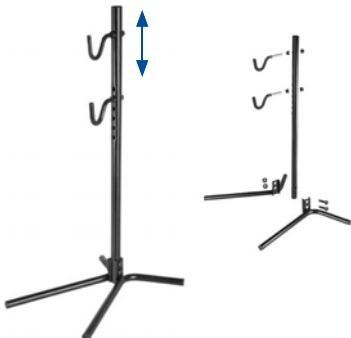
ART.-NR.	BESCHREIBUNG	DESCRIPTION	
<b>430288</b> 4	<b>VERTIKALER UND HORIZONTALER FAHRRADHALTER ›RAIMUND‹</b> <ul style="list-style-type: none"> <li>• <b>2 in 1</b></li> <li>• sehr <b>einfache Handhabung</b></li> <li>• <b>platzsparende</b> und <b>sichere</b> Unterbringung</li> <li>• für <b>Fahrräder aller Größen 12" - 29"</b></li> <li>• für Reifenbreiten bis <b>2,50"</b></li> <li>• werkzeuglose Höhenverstellung</li> <li>• mit <b>Non-Slip</b> Füßen</li> <li>• Montageverpackung</li> </ul>	<b>VERTICAL AND HORIZONTAL BICYCLE STAND ›RAIMUND‹</b> <ul style="list-style-type: none"> <li>• <b>2 in 1</b></li> <li>• very <b>easy handling</b></li> <li>• <b>space saving</b> and <b>safe</b> storage</li> <li>• suitable for <b>all bicycles 12" - 29"</b></li> <li>• for tire widths up to <b>2.50"</b></li> <li>• toolless height adjustment</li> <li>• with <b>non-slip</b> feet</li> <li>• OEM</li> </ul>	<div style="display: flex; align-items: center;"> <div style="border: 1px solid black; padding: 2px; margin-right: 10px;">2 IN 1</div> <div style="margin-right: 10px;">↔</div> <div style="border: 1px solid black; padding: 2px;">VERTICAL HORIZONTAL</div> <div style="margin-left: 20px;"> </div> </div> 
<b>430295</b> 8	<b>FAHRRADHALTER ›EASYSTAND PREMIUM‹</b> <ul style="list-style-type: none"> <li>• <b>hochwertige Ausführung</b> aus <b>Edelstahl</b></li> <li>• für <b>Fahrräder aller Größen 12" - 29"</b></li> <li>• Reifenbreite bis <b>2,50"</b></li> <li>• kein Anheben des Rades notwendig, <b>einfach hinein-/herausrollen</b></li> <li>• aus stabilem Rundrohr</li> <li>• <b>Non-Slip</b> Füße</li> <li>• mit M-Wave Banderole</li> </ul>	<b>BICYCLE STAND ›EASYSTAND PREMIUM‹</b> <ul style="list-style-type: none"> <li>• <b>high-quality</b> made of <b>stainless steel</b></li> <li>• for <b>bicycles of all sizes 12" - 29"</b></li> <li>• max. tire width up to <b>2.50"</b></li> <li>• no lifting of the bike necessary, <b>just roll in and out</b></li> <li>• solid round tubes</li> <li>• <b>non-slip</b> feet</li> <li>• with M-Wave banderole</li> </ul>	<div style="display: flex; align-items: center;"> <div style="border: 1px solid black; padding: 2px; margin-right: 10px;">STAINLESS STEEL</div> <div style="margin-left: 20px;"> </div> </div> 
<b>430298</b> 100	<b>VERBINDUNGSADAPTER</b> Machen Sie Einzelständer zum <b>variablen Mehrfachsystem!</b> <ul style="list-style-type: none"> <li>• <b>hochwertige Ausführung</b> aus <b>Edelstahl</b></li> <li>• universell passend</li> <li>• auf M-Wave Eurolochkarte</li> </ul>	<b>CONNECTOR</b> Make basic stand to a <b>variable multiple system!</b> <ul style="list-style-type: none"> <li>• <b>high-quality</b> made of <b>stainless steel</b></li> <li>• universally suitable</li> <li>• on M-Wave eurohole card</li> </ul>	  
<b>430287</b> 10	<b>AUFBEWAHRUNGS- UND MONTAGESTÄNDER ›EASYSTAND HOOK‹</b> <ul style="list-style-type: none"> <li>• <b>2 Haken</b> mit <b>Gummschutzüberzug</b></li> <li>• für <b>Fahrräder aller Größen 12" - 29"</b></li> <li>• aus stabilem Rundrohr</li> <li>• mit <b>Schaumstoff</b>breitenadapter</li> <li>• für Reifenbreiten bis <b>2,50"</b></li> <li>• mit <b>Non-Slip</b> Füßen</li> <li>• im M-Wave Einzelkarton</li> </ul>	<b>STORAGE AND MOUNTING STAND ›EASYSTAND HOOK‹</b> <ul style="list-style-type: none"> <li>• <b>2 hooks</b> with <b>rubber protection cover</b></li> <li>• for <b>bicycle of all sizes 12" - 29"</b></li> <li>• solid round tubes</li> <li>• with <b>foam</b> width adapter</li> <li>• for tire widths up to <b>2.50"</b></li> <li>• with <b>non-slip</b> feet</li> <li>• in M-Wave box</li> </ul>	<div style="display: flex; align-items: center;"> <div style="margin-right: 20px;"> </div> <div>  </div> </div>  

ART.-NR.	BESCHREIBUNG	DESCRIPTION	
  <b>430285</b> 10  <b>430280</b>  <b>430282</b> 7	<b>FAHRRADHALTER ›EASYSTAND‹</b> <ul style="list-style-type: none"> <li>• für <b>Fahrräder aller Größen 12" - 29"</b></li> <li>• Reifenbreite bis <b>2,50"</b></li> <li>• kein Anheben des Rades notwendig, <b>einfach hinein-/herausrollen</b></li> <li>• mit <b>Breitenadapter</b></li> <li>• aus stabilem Rundrohr</li> <li>• mit <b>Schaumstoffschutz</b></li> <li>• <b>Non-Slip</b> Füße</li> </ul> schwarz, im M-Wave Einzelkarton Montageverpackung	<b>BICYCLE STAND ›EASYSTAND‹</b> <ul style="list-style-type: none"> <li>• for <b>bicycles of all sizes 12" - 29"</b></li> <li>• max. tire width up to <b>2.50"</b></li> <li>• no lifting of the bike necessary, <b>just roll in and out</b></li> <li>• with <b>width adapter</b></li> <li>• solid round tubes</li> <li>• with <b>foam cover</b></li> <li>• <b>non-slip</b> feet</li> </ul> black, in M-Wave box  OEM black silver  UVP 27,90 €	   
<b>430290</b> 10	<ul style="list-style-type: none"> <li>• für Fahrräder von <b>16" - 20"</b> geeignet</li> <li>• schwarz, Montageverpackung</li> </ul>	<ul style="list-style-type: none"> <li>• suitable for bicycles from <b>16" - 20"</b></li> <li>• black, OEM</li> </ul> UVP 26,90 €	 <div data-bbox="1417 757 1554 810" style="border: 1px solid black; padding: 2px; display: inline-block;"><b>16" - 20"</b></div>
<b>430289</b> 10	<ul style="list-style-type: none"> <li>• für Fahrräder von <b>12" - 16"</b> geeignet</li> <li>• schwarz, Montageverpackung</li> </ul>	<ul style="list-style-type: none"> <li>• suitable for bicycles from <b>12" - 16"</b></li> <li>• black, OEM</li> </ul> UVP 26,90 €	 <div data-bbox="1417 860 1554 913" style="border: 1px solid black; padding: 2px; display: inline-block;"><b>12" - 16"</b></div>
<b>430291</b> 10	<b>FAHRRADHALTER ›EASYSTAND PLUS‹</b> <ul style="list-style-type: none"> <li>• <b>Reifenbreite von 2,50" - 3,25"</b></li> <li>• für <b>Fahrräder aller Größen 12" - 29"</b></li> <li>• kein Anheben des Rades notwendig, <b>einfach hinein-/herausrollen</b></li> <li>• aus stabilem Rundrohr</li> <li>• mit <b>Schaumstoffschutz</b></li> <li>• <b>Non-Slip</b> Füße</li> <li>• schwarz</li> <li>• Montageverpackung</li> </ul>	<b>BICYCLE STAND ›EASYSTAND PLUS‹</b> <ul style="list-style-type: none"> <li>• <b>tire width 2.50" - 3.25"</b></li> <li>• for <b>bicycles of all sizes 12" - 29"</b></li> <li>• no lifting of the bike necessary, <b>just roll in and out</b></li> <li>• solid round tubes</li> <li>• with <b>foam cover</b></li> <li>• <b>non-slip</b> feet</li> <li>• black</li> <li>• OEM</li> </ul> UVP 32,90 €	 <div data-bbox="1417 1115 1554 1187" style="border: 1px solid black; padding: 2px; display: inline-block;"><b>PLUS ✓ FAT ✓</b></div> 
<b>430300</b> 4 set  <b>430301</b> 10	<b>FAHRRADSTÄNDER</b> <ul style="list-style-type: none"> <li>• flexibel <b>erweiterbar</b></li> <li>• kleines Packmaß, da <b>zerlegbar</b></li> <li>• aus Stahl</li> <li>• mit <b>höhendifferenzausgleichenden elliptischen Non-Slip</b> Füßen</li> <li>• Reifenbreite bis 2,125"</li> <li>• Montageverpackung</li> </ul> Dreifachständer Einzel-/Erweiterungsständer	<b>BICYCLE STAND</b> <ul style="list-style-type: none"> <li>• flexibly <b>extendable</b></li> <li>• small packing size, because <b>demountable</b></li> <li>• made of steel</li> <li>• with <b>difference-in-height compensating, elliptical non-slip</b> feet</li> <li>• tire width up to 2.125"</li> <li>• OEM</li> </ul> triple stand single/extension stand  UVP 39,90 € UVP 24,90 €	 <div data-bbox="1385 1576 1535 1608" style="border: 1px solid black; padding: 2px; display: inline-block;"><b>EXTENDABLE</b></div> 
<b>430302</b> 30	<b>ERSATZFUß</b> <ul style="list-style-type: none"> <li>• für Art. 430300/1</li> <li>• <b>elliptische</b> Form zum <b>Höhenausgleich</b></li> <li>• Montageverpackung</li> </ul>	<b>REPLACEMENT FOOT</b> <ul style="list-style-type: none"> <li>• for art. 430300/1</li> <li>• <b>elliptical</b> shape for <b>height compensation</b></li> <li>• OEM</li> </ul> UVP 0,90 €	



ART.-NR.	BESCHREIBUNG	DESCRIPTION	
<b>430249</b> 4	<b>FAHRRADHALTER</b> <ul style="list-style-type: none"> <li>• <b>platzsparend</b> da <b>klappbar</b></li> <li>• für <b>20" - 29"</b> geeignet</li> <li>• kein Anheben des Rades notwendig, einfach <b>hinein-/herausrollen</b></li> <li>• sicherer Halt des Rades durch <b>3-Punkt-Halterung</b></li> <li>• für verschiedene Reifenbreiten <b>optimiert</b></li> </ul>	<b>BICYCLE STAND</b> <ul style="list-style-type: none"> <li>• <b>space saving</b> because <b>foldable</b></li> <li>• suitable for <b>20" - 29"</b></li> <li>• no lifting of the bike necessary, <b>just roll in and out</b></li> <li>• secure stand of the bicycle through <b>3-point fitting</b></li> <li>• <b>optimized</b> for different tire widths</li> </ul>	<ul style="list-style-type: none"> <li>✓ <b>MTB (29"-26")</b></li> <li>✓ <b>ROAD (700 X 20-45C)</b></li> <li>✓ <b>KIDS</b></li> </ul>   <p>UVP 32,90 €</p>
<b>439903</b> 10	<b>FAHRRADHALTER ›CHOPSTAND APART‹</b> <ul style="list-style-type: none"> <li>• <b>werkzeug- und stufenlos höhenverstellbar um 150 mm</b></li> <li>• <b>platzsparend zerlegbar</b></li> <li>• mit <b>Kratzschutz</b></li> <li>• für <b>12" - 29"</b> geeignet</li> <li>• für Verwendung an der Vorder- oder Hinterradachse</li> <li>• für fast alle Räder mit <b>Scheibenbremsen geeignet</b></li> <li>• in M-Wave Eurolochbox</li> </ul>	<b>BICYCLE STAND ›CHOPSTAND APART‹</b> <ul style="list-style-type: none"> <li>• <b>150 mm stepless height adjustment without tools</b></li> <li>• <b>space savingly demountable</b></li> <li>• with <b>scratch protection</b></li> <li>• suitable for <b>12" - 29"</b></li> <li>• for using at the front or rear axle</li> <li>• suitable for almost every bike with <b>disc brakes</b></li> <li>• in M-Wave eurohole box</li> </ul>	   <p>UVP 20,90 €</p>
<b>430252</b> 5	<b>FAHRRADHALTER</b> <ul style="list-style-type: none"> <li>• mit <b>Kratzschutz</b></li> <li>• für <b>12" - 29"</b> geeignet</li> <li>• für Verwendung an der <b>Vorder- oder Hinterradachse</b></li> <li>• für fast alle Räder mit <b>Scheibenbremsen geeignet</b></li> </ul>	<b>BICYCLE STAND</b> <ul style="list-style-type: none"> <li>• with <b>scratch protection</b></li> <li>• suitable for <b>12" - 29"</b></li> <li>• for using at the <b>front or rear</b> axle</li> <li>• usable for almost every bike with <b>disc brakes</b></li> </ul>	 <p>UVP 22,90 €</p>
<b>430225</b> 20	<b>FAHRRADHALTER</b> <ul style="list-style-type: none"> <li>• Kunststoff<b>überzug</b> als Verkratzschutz</li> <li>• durch 4 schwarze Rollen <b>leicht zu verschieben</b></li> <li>• zerlegbar, dadurch platzsparende Lagerung und einfacher Transport</li> <li>• für <b>verschiedene Reifenbreiten</b> einstellbar</li> <li>• Stahl</li> <li>• <b>universell</b> passend für <b>12" - 29"</b> Fahrräder</li> </ul>	<b>BICYCLE STAND</b> <ul style="list-style-type: none"> <li>• plastic <b>cover</b> for scratch protection</li> <li>• 4 black wheels for <b>easy moving</b></li> <li>• demountable, therefore space saving storage and easy transport</li> <li>• adjustable to <b>different tire sizes</b></li> <li>• steel</li> <li>• <b>universally</b> suitable for <b>12" - 29"</b> bikes</li> </ul>	 <p>UVP 19,90 €</p>
<b>430245</b> 10	<b>FAHRRADHALTER</b> <ul style="list-style-type: none"> <li>• zum Einhängen am Hinterbau</li> <li>• in der <b>Höhe verstellbar</b></li> <li>• passend für <b>12" - 29"</b> Räder</li> <li>• auch für <b>Oversize-Hinterbau</b> und für <b>gefederte Rahmen</b></li> <li>• zerlegbar</li> <li>• platzsparende Lagerung</li> <li>• einfacher Transport</li> </ul>	<b>BICYCLE STAND</b> <ul style="list-style-type: none"> <li>• mounting position at the rear stay</li> <li>• <b>height adjustable</b></li> <li>• suitable for <b>12" - 29"</b> bikes</li> <li>• also for <b>oversize rear stay</b> and for <b>suspension frames</b></li> <li>• demountable</li> <li>• space saving storage</li> <li>• easy transport</li> </ul>	 <p>UVP 14,90 €</p>

ART.-NR.	BESCHREIBUNG	DESCRIPTION	
<p><b>430244</b></p> <p>25</p>	<p><b>FAHRRADHALTER</b></p> <ul style="list-style-type: none"> <li>• platzsparend <b>zusammenklappbar</b></li> <li>• für <b>12" - 29"</b> geeignet</li> <li>• Montageverpackung</li> </ul> <p>• universelle Montage an der <b>Kettenstrebe</b> oder der <b>Hinterradachse</b></p> <ul style="list-style-type: none"> <li>• besonders <b>geeignet für</b> Räder mit <b>12 mm Steckachsen</b></li> <li>• mit Sicherungs-/Befestigungsgummi</li> </ul>	<p><b>BICYCLE STAND</b></p> <ul style="list-style-type: none"> <li>• space savingly <b>foldable</b></li> <li>• suitable for <b>12" - 29"</b></li> <li>• OEM</li> </ul> <p>• universal mounting position at the <b>chain stay</b> or at the <b>rear hub axle</b></p> <ul style="list-style-type: none"> <li>• especially <b>suitable for</b> bikes with <b>12 mm thru axle</b></li> <li>• with securing/fixing rubber</li> </ul> <p>UVP 13,90 €</p>	 <p><b>CHAIN STAY MOUNT</b></p> <p><b>AXLE MOUNT</b></p>
<p><b>430247</b></p> <p>20</p>	<p>• zur Montage an der Hinterradachse</p> <ul style="list-style-type: none"> <li>• mit <b>Ausbuchtung für Schnellspanner</b></li> </ul>	<p>• mounting position at the rear hub axle</p> <ul style="list-style-type: none"> <li>• with <b>cut out for QR</b></li> </ul> <p>UVP 12,90 €</p>	
<p><b>430240</b></p> <p>30</p>	<p><b>FAHRRADHALTER</b></p> <ul style="list-style-type: none"> <li>• zur Befestigung am Tretlager</li> <li>• geeignet für alle Fahrräder mit <b>Shimano Hollowtech II</b> Kurbelgarnitur</li> <li>• Drehen des Hinterrads zur <b>Schaltungs-einstellung</b>, ... möglich</li> <li>• mit <b>Verkratzschutz</b></li> <li>• <b>zerlegbar</b></li> <li>• platzsparende Lagerung und Transport</li> <li>• kleines Verpackungsmaß</li> </ul>	<p><b>BICYCLE STAND</b></p> <ul style="list-style-type: none"> <li>• for mounting on bottom bracket</li> <li>• suitable for all bicycles with <b>Shimano Hollowtech II</b> crank set</li> <li>• turnable rear wheel for <b>shifting adjustment</b>, ...</li> <li>• with <b>scratch protection</b></li> <li>• <b>demountable</b></li> <li>• space saving storage and transport</li> <li>• small packing dimensions</li> </ul> <p>UVP 14,90 €</p>	
<p><b>430224</b></p> <p>40</p>	<p><b>FAHRRADHALTER</b></p> <ul style="list-style-type: none"> <li>• für (16"+) 20" (+24") <b>Einrad</b></li> </ul>	<p><b>BICYCLE STAND</b></p> <ul style="list-style-type: none"> <li>• for (16"+) 20" (+24") <b>unicycle</b></li> </ul> <p>UVP 8,90 €</p>	
<p><b>430098</b></p> <p>6 set</p>	<p><b>FAHRRADLIFT</b></p> <p>›BIKE LIFT STRONG‹</p> <ul style="list-style-type: none"> <li>• mit <b>Gummi überzogenen</b> Befestigungshaken zum Schutz vor Verkratzen des Fahrrads</li> <li>• <b>stabiles Rundseil</b> Ø 6,5 mm</li> <li>• bis zu 4 m Höhe</li> <li>• geeignet bis <b>57 kg, daher für E-Bikes nutzbar</b></li> <li>• im M-Wave Einzelkarton</li> </ul>	<p><b>BICYCLE LIFT</b></p> <p>›BIKE LIFT STRONG‹</p> <ul style="list-style-type: none"> <li>• hooks with <b>plastic covers</b> for scratch protection</li> <li>• <b>stable round rope</b> Ø 6.5 mm</li> <li>• up to 4 m ceiling height</li> <li>• usable up to <b>57 kg, so suitable for E-bikes</b></li> <li>• in M-Wave box</li> </ul> <p>UVP 41,90 €</p>	<p>• <b>E-BIKE</b> ✓</p> <p>• <b>57 KG</b> ✓</p>  <p>M-WAVE</p>



ART.-NR.	BESCHREIBUNG	DESCRIPTION	
<p><b>430099</b></p> <p>10 set</p>	<p><b>FAHRRADLIFT</b></p> <ul style="list-style-type: none"> <li>• schwarz</li> <li>• mit <b>Gummi überzogenen</b> Befestigungshaken zum Schutz vor Verkratzen des Fahrrads</li> <li>• <b>stabiles Rundseil</b> Ø 5 mm</li> <li>• bis zu 4 m Höhe</li> <li>• geeignet bis 20 kg Hebegewicht</li> <li>• im Ventura Einzelkarton</li> </ul>	<p><b>BICYCLE LIFT</b></p> <ul style="list-style-type: none"> <li>• black</li> <li>• hooks with <b>plastic covers</b> for scratch protection</li> <li>• <b>stable round rope</b> Ø 5 mm</li> <li>• up to 4 m ceiling height</li> <li>• usable up to 20 kg lifting load</li> <li>• in Ventura box</li> </ul>	<p>Tested up to 20 kg</p> <p><b>VENTURA</b> BIKE + OUTDOOR</p>  <p>UVP 21,90 €</p>
<p><b>439985</b></p> <p>20 pair</p>	<p><b>STÜTZRÄDER ›FLIP-UP‹</b></p> <ul style="list-style-type: none"> <li>• für Kinder-Fahrräder</li> <li>• <b>hochklappbar ohne Werkzeug</b></li> <li>• passend für <b>12" - 20"</b></li> <li>• paarweise im Einzelkarton</li> </ul>	<p><b>STABILIZER ›FLIP-UP‹</b></p> <ul style="list-style-type: none"> <li>• for children bikes</li> <li>• <b>foldable without tool</b></li> <li>• suitable for <b>12" - 20"</b></li> <li>• one pair in box</li> </ul>	 <p><b>TRAILGATOR</b> THE BICYCLE TOW BAR</p>  <p>UVP 53,90 €</p>
<p><b>439991</b></p> <p>10 pair</p>	<p><b>STÜTZRÄDER</b></p> <ul style="list-style-type: none"> <li>• nach <b>ISO 8098</b></li> <li>• für Kinder-Fahrräder</li> <li>• passend für <b>12" - 20"</b></li> <li>• mit Zusatzstrebe als <b>Drehschutz</b></li> </ul> <p>paarweise im Polybeutel</p>	<p><b>STABILIZER</b></p> <ul style="list-style-type: none"> <li>• according to <b>ISO 8098</b></li> <li>• for children bikes</li> <li>• suitable for <b>12" - 20"</b></li> <li>• with <b>anti-turn</b> bracket</li> </ul> <p>one pair in PE bag</p>	<p>according to ISO 8098</p> <p><b>M-WAVE</b></p>   <p>UVP 9,90 €</p> <p>UVP 13,90 €</p>
<p><b>439982</b></p> <p>10 pair</p>	<p><b>STÜTZRÄDER</b></p> <ul style="list-style-type: none"> <li>• für Kinder-Fahrräder</li> <li>• passend für <b>12" - 20"</b></li> <li>• mit Zusatzstrebe als <b>Drehschutz</b></li> <li>• paarweise im Polybeutel</li> </ul>	<p><b>STABILIZER</b></p> <ul style="list-style-type: none"> <li>• for children bikes</li> <li>• suitable for <b>12" - 20"</b></li> <li>• with <b>anti-turn</b> bracket</li> <li>• one pair in PE bag</li> </ul>	 <p>UVP 7,90 €</p>











# BASKETS





ART.-NR.	BESCHREIBUNG	DESCRIPTION	
<b>431570</b> 5	<b>WEIDENKORB ›BA-FW CLIP STEM‹</b> <ul style="list-style-type: none"> <li>aus echtem <b>Weidengeflecht</b></li> <li>handgemacht</li> <li>Montage vorne mit <b>Clip-on</b>-Halter für Vorbau oder Steuersatzrohr</li> <li>ca. 38 x 28 x 27 cm</li> <li>mit M-Wave Karte</li> </ul>	<b>WICKER BASKET ›BA-FW CLIP STEM‹</b> <ul style="list-style-type: none"> <li>made of genuine <b>wicker network</b></li> <li>handmade</li> <li>mounting at the front with <b>clip-on</b> bracket for stem or head set tube</li> <li>approx. 38 x 28 x 27cm</li> <li>with M-Wave card</li> </ul>	 
<b>431571</b> 100/10	<b>ERSATZ-/ZWEIT-CLIP-ON-HALTER</b> <b>universell</b> passend für Art. 431570 und viele andere Körbe	<b>REPLACEMENT/SECOND CLIP-ON BRACKET</b> <b>universally</b> suitable for art. 431570 and many other baskets	
<b>431572</b> 5	<b>WEIDENKORB ›BA-FW CLIP BAR‹</b> <ul style="list-style-type: none"> <li>aus echtem <b>Weidengeflecht</b></li> <li>handgemacht</li> <li>inkl. <b>Clip-on</b>-Halter für Lenkermontage (Ø 22,2 - 31,8 mm)</li> <li>ca. 38 x 28 x 26 cm</li> <li>Ersatz-/ Zweit-Clip-on-Halter: Art. 122709</li> <li>mit M-Wave Karte</li> </ul>	<b>WICKER BASKET ›BA-FW CLIP BAR‹</b> <ul style="list-style-type: none"> <li>made of genuine <b>wicker network</b></li> <li>handmade</li> <li>incl. <b>clip-on</b> bracket for mounting at handlebar (Ø 22.2 - 31.8 mm)</li> <li>approx. 38 x 28 x 26 cm</li> <li>replacement/ second clip-on bracket: art. 122709</li> <li>with M-Wave card</li> </ul>	 
<b>431650</b> 3	<b>WEIDENKORB ›UNIVERSAL‹</b> <ul style="list-style-type: none"> <li>aus echtem <b>Weidengeflecht</b></li> <li>handgemacht</li> <li>mit Deckel</li> <li>z. B. für Vorderrad-Gepäckträger Art. 440455</li> <li>ca. 40 x 33 x 25,5 cm</li> <li>mit M-Wave Karte</li> </ul>	<b>WICKER BASKET ›UNIVERSAL‹</b> <ul style="list-style-type: none"> <li>made of genuine <b>wicker network</b></li> <li>handmade</li> <li>with lid</li> <li>e. g. for front wheel carrier art. 440455</li> <li>approx. 40 x 33 x 25.5 cm</li> <li>with M-Wave card</li> </ul>	 



ART.-NR. 	BESCHREIBUNG	DESCRIPTION	
<b>431605</b> 4	<b>WEIDENKORB ›CARRIER TOP‹</b> <ul style="list-style-type: none"> <li>• aus echtem <b>Weidengeflecht</b></li> <li>• handgemacht</li> <li>• mit "Deckel" aus Stahldraht</li> <li>• <b>werkzeuglose Befestigung</b> am Gepäckträger</li> <li>• auch für Haustiere geeignet</li> <li>• ca. 43,5 x 31 x 22/16,5 cm</li> <li>• mit M-Wave Karte</li> </ul>	<b>WICKER BASKET ›CARRIER TOP‹</b> <ul style="list-style-type: none"> <li>• made of genuine <b>wicker network</b></li> <li>• handmade</li> <li>• with steel wire „lid“</li> <li>• <b>toolless mounting</b> on carrier</li> <li>• also for pets</li> <li>• approx. 43.5 x 31 x 22/16.5 cm</li> <li>• with M-Wave card</li> </ul> <p style="text-align: right;">UVP 91,90 €</p>	   
<b>431604</b> 2	<b>WEIDENKORB ›BA PET‹</b> <ul style="list-style-type: none"> <li>• aus echtem <b>Weidengeflecht</b></li> <li>• handgemacht</li> <li>• mit "Deckel" aus Stahldraht</li> <li>• Befestigung mit <b>Clip-on-Halter am Sitzrohr oder Vorbau</b></li> <li>• auch für Haustiere geeignet</li> <li>• ca. 43 x 29,5 x 22/14 cm</li> <li>• mit M-Wave Karte</li> </ul>	<b>WICKER BASKET ›BA PET‹</b> <ul style="list-style-type: none"> <li>• made of genuine <b>wicker network</b></li> <li>• handmade</li> <li>• with steel wire „lid“</li> <li>• mounting with <b>clip-on bracket on seat tube or stem</b></li> <li>• also for pets</li> <li>• approx. 43 x 29.5 x 22/14 cm</li> <li>• with M-Wave card</li> </ul> <p style="text-align: right;">UVP 94,90 €</p>	<p><b>2 IN 1</b></p>   







LINK TO PERFECTION



ART.-NR.	BESCHREIBUNG	DESCRIPTION	
431515 10	<b>DRAHTKORB ›BA-F CLIP BAR‹</b> <ul style="list-style-type: none"> <li>• besonders <b>stabile</b> und <b>hochwertige Ausführung</b></li> <li>• aus feinmaschigem Stahlgeflecht</li> <li>• <b>verstärkte</b> Haupt- und Nebenstreben</li> <li>• <b>kunststoffummantelter, ergonomischer Tragegriff</b></li> <li>• ca. 35 x 25 x 25/22 cm</li> <li>• <b>mit Clip-on-Halter</b> (Art. 122709) für Montage am Lenker (<b>Ø 22,2 mm - Ø 31,8 mm</b>) und Abstützung am Vorbau</li> <li>• <b>Neigungswinkel einstellbar</b></li> <li>• mit M-Wave Logoplatte</li> <li>• mit M-Wave Karte</li> </ul>	<b>WIRE BASKET ›BA-F CLIP BAR‹</b> <ul style="list-style-type: none"> <li>• very <b>firm</b> and <b>high quality design</b></li> <li>• fine meshed steel net</li> <li>• <b>reinforced</b> main and auxiliary bars</li> <li>• <b>plastic covered, ergonomic handle</b></li> <li>• approx. 35 x 25 x 25/22 cm</li> <li>• <b>with clip-on bracket</b> (art. 122709) for assembling on handlebar (<b>Ø 22.2 mm - Ø 31.8 mm</b>) and brace support on the stem</li> <li>• <b>adjustable angle</b></li> <li>• with M-Wave logo plate</li> <li>• with M-Wave card</li> </ul>	<p>CLIP-ON</p> <p>M-WAVE</p> <p>UVP 21,90 €</p>
431525 431526 10	<b>DRAHTKORB</b> <ul style="list-style-type: none"> <li>• besonders <b>stabile</b> und <b>hochwertige Ausführung</b></li> <li>• aus feinmaschigem Stahlgeflecht</li> <li>• <b>verstärkte</b> Haupt- und Nebenstreben</li> <li>• <b>kunststoffummantelter, ergonomischer Tragegriff</b></li> <li>• mit stabilem Vorbau-<b>Clip-on-Halter</b> für 1" und 1 1/8" Vorbauten</li> <li>• mit M-Wave Logoplatte</li> <li>• mit M-Wave Karte</li> </ul> <b>›BA-F CLIP STEM‹</b> ca. 33,5 x 25,5 x 25,5/22 cm (B x L x H)	<b>WIRE BASKET</b> <ul style="list-style-type: none"> <li>• very <b>firm</b> and <b>high quality design</b></li> <li>• fine meshed steel net</li> <li>• <b>reinforced</b> main and auxiliary bars</li> <li>• <b>plastic covered, ergonomic handle</b></li> <li>• with firm stem <b>clip-on bracket</b> for 1" and 1 1/8" stems</li> <li>• with M-Wave logo plate</li> <li>• with M-Wave card</li> </ul> <b>›BA-F CLIP STEM‹</b> approx. 33.5 x 25.5 x 25.5/22 cm (W x L x H)	<p>CLIP-ON</p> <p>M-WAVE</p> <p>UVP 19,90 €</p> <p>CLIP-ON</p> <p>M-WAVE</p> <p>UVP 18,90 €</p>
431518 10	<b>DRAHTKORB ›CLIP-ON‹</b> <ul style="list-style-type: none"> <li>• Größe ca. 34,5 x 26,5 x 26/22,5 cm</li> <li>• schwarz</li> <li>• <b>Winkel verstellbar</b></li> <li>• feinmaschiges Stahlgeflecht</li> <li>• mit Verstärkungen</li> <li>• <b>mit patentiertem Clip-on-Halter</b> für Montage am Lenker (<b>Ø 22,2 - Ø 31,8 mm</b>) und Vorbau</li> <li>• mit Ventura Karte</li> </ul>	<b>WIRE BASKET ›CLIP-ON‹</b> <ul style="list-style-type: none"> <li>• size approx. 34.5 x 26.5 x 26/22.5 cm</li> <li>• black</li> <li>• <b>adjustable angle</b></li> <li>• fine meshed steel net</li> <li>• with reinforcements</li> <li>• <b>with patented clip-on bracket</b> for assembling on handlebar (<b>Ø 22.2 - Ø 31.8 mm</b>) and stem</li> <li>• with Ventura card</li> </ul>	<p>CLIP-ON</p> <p>VENTURA® BIKE + OUTDOOR</p> <p>REGISTERED DESIGN PATENT</p> <p>UVP 21,90 €</p>
431523 50 set	<b>Ersatz-/Zweit-Clip-on-Halter</b> <ul style="list-style-type: none"> <li>• für Art. 431518, ... <b>universell einsetzbar</b> auch für andere Körbe</li> <li>• für Lenker Ø 22,2 - Ø 31,8 mm</li> </ul>	<b>replacement/second clip-on bracket</b> <ul style="list-style-type: none"> <li>• for art. 431518, ... <b>universally useable</b> for other baskets as well</li> <li>• for handlebar Ø 22.2 - Ø 31.8 mm</li> </ul>	<p>22,2 - 31,8</p> <p>UVP 6,90 €</p>

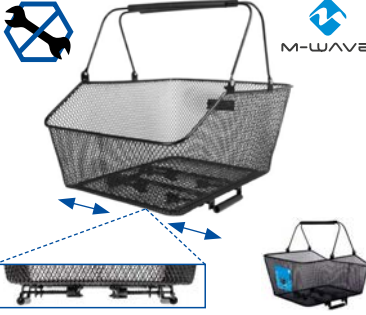

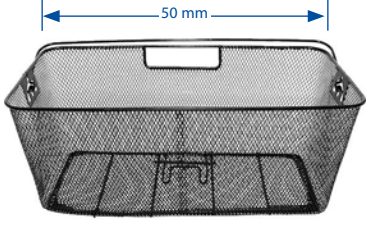







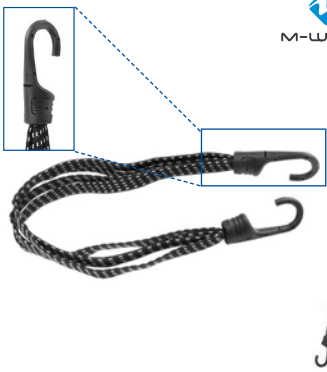

ART.-NR.	BESCHREIBUNG	DESCRIPTION	
<b>431542</b> 10	<b>DRAHTKORB ›BA-RM CLAMP L‹</b> <ul style="list-style-type: none"> <li>• besonders <b>stabile</b> und <b>hochwertige Ausführung</b></li> <li>• <b>verstärkte</b> Haupt- und Nebenstreben</li> <li>• <b>2 mit Schaumstoff ummantelte Tragegriffe</b></li> <li>• ca. 45,5 x 29,5 x 21/13 cm (B x L x H)</li> <li>• werkzeuglose Montage mit <b>Clip-on Klemmbefestigung</b></li> <li>• mit M-Wave Logoplatte</li> <li>• mit M-Wave Karte</li> </ul>	<b>WIRE BASKET ›BA-RM CLAMP L‹</b> <ul style="list-style-type: none"> <li>• very <b>firm</b> and <b>high quality design</b></li> <li>• <b>reinforced</b> main and auxiliary bars</li> <li>• <b>2 foam covered handles</b></li> <li>• approx. 45.5 x 29.5 x 21/13 cm (W x L x H)</li> <li>• toolless mounting with <b>clip-on clamp fixation</b></li> <li>• with M-Wave logo plate</li> <li>• with M-Wave card</li> </ul> <p style="text-align: right;">UVP 26,90 €</p>	
<b>431593</b> 10	<b>DRAHTKORB ›BA-RM CLAMP W‹</b> <ul style="list-style-type: none"> <li>• besonders <b>stabile</b> und <b>hochwertige Ausführung</b></li> <li>• <b>verstärkte</b> Haupt- und Nebenstreben</li> <li>• <b>kunststoffummantelter, ergonomischer Tragegriff</b></li> <li>• ca. 41 x 31 x 17 cm</li> <li>• werkzeuglose Montage mit <b>Clip-on Klemmbefestigung</b></li> <li>• mit M-Wave Logoplatte</li> <li>• mit M-Wave Karte</li> </ul>	<b>WIRE BASKET ›BA-RM CLAMP W‹</b> <ul style="list-style-type: none"> <li>• very <b>firm</b> and <b>high quality design</b></li> <li>• <b>reinforced</b> main and auxiliary bars</li> <li>• <b>plastic covered ergonomic handle</b></li> <li>• approx. 41 x 31 x 17 cm</li> <li>• toolless mounting with <b>clip-on clamp fixation</b></li> <li>• with M-Wave logo plate</li> <li>• with M-Wave card</li> </ul> <p style="text-align: right;">UVP 21,90 €</p>	
<b>431592</b> 15	<b>DRAHTKORB ›BA-RM XL‹</b> <ul style="list-style-type: none"> <li>• besonders <b>stabile</b> und <b>hochwertige Ausführung</b></li> <li>• <b>verstärkte</b> Haupt- und Nebenstreben</li> <li>• <b>kunststoffummantelter, ergonomischer Tragegriff</b></li> <li>• ca. 51 x 30 x 20 cm</li> <li>• besonders <b>breit</b> für Schultaschen und Aktenkoffer</li> <li>• mit M-Wave Logoplatte</li> </ul>	<b>WIRE BASKET ›BA-RM XL‹</b> <ul style="list-style-type: none"> <li>• very <b>firm</b> and <b>high quality design</b></li> <li>• <b>reinforced</b> main and auxiliary bars</li> <li>• <b>plastic covered ergonomic handle</b></li> <li>• approx. 51 x 30 x 20 cm</li> <li>• very <b>wide</b> for school bags and briefcases</li> <li>• with M-Wave logo plate</li> </ul> <p style="text-align: right;">UVP 19,90 €</p>	
<b>431545</b> 20	<b>AKTENKOFFER-/SCHULTASCHENKORB</b> <ul style="list-style-type: none"> <li>• aus feinmaschigem <b>Stahlgeflecht</b></li> <li>• mit <b>Verstärkungsstreben</b></li> <li>• mit zwei Befestigungshaken am Boden für Gepäckträgermontage</li> <li>• mit Schlitz für Gepäckträgerklappe</li> <li>• ca. <b>50</b> x 26 x 20 cm</li> </ul>	<b>SUITCASE/SCHOOLBAG BASKET</b> <ul style="list-style-type: none"> <li>• made of fine meshed <b>steel net</b></li> <li>• with <b>reinforcement stays</b></li> <li>• with two hooks at the bottom for assembling on the carrier</li> <li>• with slit for carrier flap</li> <li>• approx. <b>50</b> x 26 x 20 cm</li> </ul> <p style="text-align: right;">UVP 16,90 €</p>	
<b>431594</b> 10	<b>DRAHTKORB ›BA-RM XXL‹</b> <ul style="list-style-type: none"> <li>• <b>stabile</b> und <b>hochwertige Ausführung</b></li> <li>• <b>verstärkte</b> Haupt- und Nebenstreben</li> <li>• mit M-Wave Logoplatte</li> <li>• mit M-Wave Karte</li> </ul>	<b>WIRE BASKET ›BA-RM XXL‹</b> <ul style="list-style-type: none"> <li>• <b>firm</b> and <b>high quality design</b></li> <li>• <b>reinforced</b> main and auxiliary bars</li> <li>• with M-Wave logo plate</li> <li>• with M-Wave card</li> </ul>	<div style="border: 1px solid black; padding: 2px; display: inline-block;"><b>XXL</b></div> 
<b>431550</b> 10	<b>DRAHTKORB ›BA-RM Along‹</b> <ul style="list-style-type: none"> <li>• zur <b>festen Montage längs</b> über dem Gepäckträger</li> <li>• ca. 45 x 30 x 20/13 cm (L x B x H)</li> <li>• besonders <b>schmal</b> und daher nicht seitlich überstehend</li> </ul>	<b>WIRE BASKET ›BA-RM Along‹</b> <ul style="list-style-type: none"> <li>• for <b>fixed installation lengthwise</b> on the carrier</li> <li>• approx. 45 x 30 x 20/13 cm (L x W x H)</li> <li>• extra <b>narrow</b>, therefore non-protruding from both sides</li> </ul> <p style="text-align: right;">UVP 18,90 €</p>	

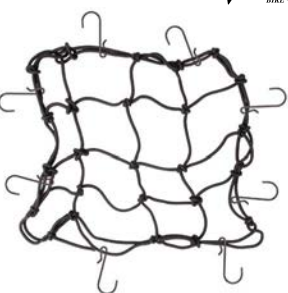

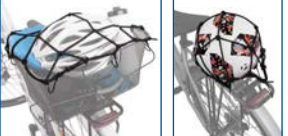





ART.-NR.	BESCHREIBUNG	DESCRIPTION	
  <b>431555</b>  <b>431424</b>  <b>431428</b> 60	<b>KINDER-DRAHTKORB</b> <ul style="list-style-type: none"> <li>• feinmaschiges Stahlgeflecht</li> <li>• ca. 24 x 15 x 14,5 cm</li> <li>• <b>universeller, biegbarer Befestigungsbügel</b></li> <li>• für Lenker, Vorbau, Gepäckträger, ...</li> </ul> schwarz  blau  pink	<b>CHILDREN'S WIRE BASKET</b> <ul style="list-style-type: none"> <li>• fine meshed steel net</li> <li>• approx. 24 x 15 x 14.5 cm</li> <li>• <b>universal, twistable mounting bracket</b></li> <li>• for handlebar, stem, carrier, ...</li> </ul> black  blue  pink	     UVP 5,90 €
<b>431559</b>  <b>431549</b>  <b>431552</b>  <b>431551</b>  <b>431556</b> 48	<b>KINDERKORB</b> <ul style="list-style-type: none"> <li>• aus Kunststoff</li> <li>• ca. 20 x 14 x 13 cm</li> <li>• universelle Befestigung mit Kunststoffbändern am Lenker, Gepäckträger, ...</li> </ul> farbig sortiert  blau  rot  gelb  pink	<b>CHILDREN'S BASKET</b> <ul style="list-style-type: none"> <li>• made of plastic</li> <li>• approx. 20 x 14 x 13 cm</li> <li>• universal mounting with plastic straps on handlebar, carrier, ...</li> </ul> assorted colours  blue  red  yellow  pink	      UVP 3,90 €
<b>122352</b> 100	<b>KORB + TASCHENÜBERZUG</b> <b>&gt;MAASTRICHT PROTECT&lt;</b> <ul style="list-style-type: none"> <li>• <b>universeller</b> Regenschutz für <b>Körbe</b>, Rucksäcke bis ca. 25 Liter, Vorderradtaschen, Gepäcktaschen, ...</li> <li>• mit <b>2 Haltegurten</b> auf der Rückseite</li> <li>• neongelb</li> <li>• <b>3M Scotchlite® Reflexstreifen</b> auf drei Seiten</li> <li>• mit aufgesetzter Netztasche</li> <li>• auf M-Wave Eurolochkarte</li> </ul>	<b>BASKET + BAG COVER</b> <b>&gt;MAASTRICHT PROTECT&lt;</b> <ul style="list-style-type: none"> <li>• <b>universal</b> rain protection for <b>baskets</b>, backpack up to approx. 25 litres, front bags, rear bags, ...</li> <li>• with <b>2 fixation straps</b> on back</li> <li>• neon yellow</li> <li>• <b>3M Scotchlite® reflective stripes</b> on three sides</li> <li>• with fitted net pocket</li> <li>• on M-Wave eurohole card</li> </ul>	       UVP 10,90 €

ART.-NR.	BESCHREIBUNG	DESCRIPTION	
<b>780168</b> 50 pair 	<b>GEPÄCKGURT</b> <ul style="list-style-type: none"> <li>• sehr <b>stabile Stahlhaken</b> mit <b>Kunststoffummantelung</b></li> <li>• flacher Gummispanngurt</li> <li>• <b>vierfach</b></li> <li>• 600 x 13 mm</li> <li>• ein <b>Paar</b> auf <b>M-Wave Eurolochkarte</b></li> </ul>	<b>BUNGEE CORD</b> <ul style="list-style-type: none"> <li>• very <b>strong steel hooks</b> with <b>plastic cover</b></li> <li>• flat bungee cord</li> <li>• <b>quadruple</b></li> <li>• 600 x 13 mm</li> <li>• one <b>pair</b> on <b>M-Wave eurohole card</b></li> </ul>	  <p>UVP 8,90 €</p>
<b>780160</b> 200/10 <b>780161</b> <b>780162</b> <b>780163</b> 100/10	<b>GEPÄCKGURTE</b> mit <b>starken</b> , ummantelten Stahlhaken, schwarz 50 cm lang, Ø 8 mm 60 cm lang, Ø 10 mm 80 cm lang, Ø 10 mm 100 cm lang, Ø 10 mm	<b>BUNGEE CORDS</b> with <b>strong</b> , coated steel hooks, black 50 cm length, Ø 8 mm 60 cm length, Ø 10 mm 80 cm length, Ø 10 mm 100 cm length, Ø 10 mm	 <p>UVP 1,39 € UVP 1,59 € UVP 1,69 € UVP 1,89 €</p>
<b>780273</b> 100/10	<b>GEPÄCKSPINNE</b> <ul style="list-style-type: none"> <li>• mit <b>starken</b>, ummantelten Stahlhaken</li> <li>• schwarz</li> <li>• 4-armig</li> <li>• 25 cm lang / Ø 8 mm</li> </ul>	<b>BUNGEE CORD</b> <ul style="list-style-type: none"> <li>• with <b>strong</b>, coated steel hooks</li> <li>• black</li> <li>• 4 arms</li> <li>• 25 cm length / Ø 8 mm</li> </ul>	 <p>UVP 2,49 €</p>
<b>781057</b> 100/10	<b>VIERFACH GUMMI-GEPÄCKBAND</b> <ul style="list-style-type: none"> <li>• mit <b>starken</b>, ummantelten Stahlhaken</li> <li>• Flachgummi</li> <li>• 60 cm lang</li> <li>• schwarz</li> </ul>	<b>FOURFOLD BUNGEE CORD</b> <ul style="list-style-type: none"> <li>• with <b>strong</b>, coated steel hooks</li> <li>• flat rubber</li> <li>• 60 cm length</li> <li>• black</li> </ul>	 <p>UVP 2,90 €</p>
<b>784300</b> 100	<b>FAHRRAD-GEPÄCKNETZ</b> <ul style="list-style-type: none"> <li>• schwarz</li> <li>• inkl. <b>8 Haken</b>, <b>individuell platzierbar</b></li> <li>• auch für engmaschige Körbe geeignet</li> <li>• universell anwendbar</li> <li>• auf Ventura Eurolochkarte</li> </ul>	<b>BICYCLE CARRIER NET</b> <ul style="list-style-type: none"> <li>• black</li> <li>• incl. <b>8 hooks</b>, <b>individually placeable</b></li> <li>• also suitable for tight-meshed baskets</li> <li>• universally applicable</li> <li>• on Ventura eurohole card</li> </ul>	    <p>UVP 4,99 €</p>



# CARRIERS



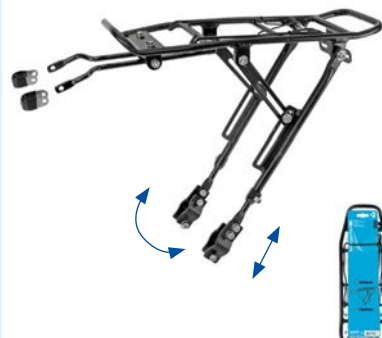



ART.-NR.	BESCHREIBUNG	DESCRIPTION	
<b>440280</b> 16	<b>ALUMINIUM-GEPÄCKTRÄGER ›DISC‹</b> <ul style="list-style-type: none"> <li>• <b>verstellbar</b> für 24" - 29"</li> <li>• spezielle Passform für Räder mit <b>Scheibenbremsen</b>, dicken Strebenenden, ...</li> <li>• mit Reflektor-/Rücklichthalter und Federklappe</li> <li>• mit <b>Universalbefestigungsset</b></li> <li>• Auflagefläche: 34 x 13 cm (L x B)</li> </ul>	<b>ALUMINIUM CARRIER ›DISC‹</b> <ul style="list-style-type: none"> <li>• <b>adjustable</b> for 24" - 29"</li> <li>• special construction for bicycles with <b>disc brakes</b>, massive chainstay ends, ...</li> <li>• with reflector/rear light bracket and spring flap</li> <li>• with <b>universal fitting set</b></li> <li>• loading surface: 34 x 13 cm (L x W)</li> </ul>	  UVP 54,90 €
<b>449901</b> 8 <b>TIP</b>	<b>ALUMINIUM-GEPÄCKTRÄGER</b> <ul style="list-style-type: none"> <li>• <b>verstellbar</b> für 24" - 29"</li> <li>• spezielle Passform für Räder mit <b>Scheibenbremsen</b>, dicken Strebenenden, ...</li> <li>• bei Kürzung der Abstandshalter auch für <b>Boost-Standard</b> geeignet</li> <li>• für <b>Gepäckträgertaschen</b></li> <li>• mit Reflektor-/Rücklichthalter und Federklappe</li> <li>• Auflagefläche: 38 x 13,5 cm (L x B)</li> <li>• Montageverpackung</li> </ul>	<b>ALUMINIUM CARRIER</b> <ul style="list-style-type: none"> <li>• <b>adjustable</b> for 24" - 29"</li> <li>• special construction for bicycles with <b>disc brakes</b>, massive chainstay ends, ...</li> <li>• when shortening the spacers also suitable for <b>boost standard</b></li> <li>• for <b>carrier bags</b></li> <li>• with reflector/rear light bracket and spring flap</li> <li>• loading surface: 38 x 13.5 cm (L x W)</li> <li>• OEM</li> </ul>	 UVP 38,90 €
<b>440186</b> 8	<b>ALUMINIUM-GEPÄCKTRÄGER ›DISC II‹</b> <ul style="list-style-type: none"> <li>• <b>verstellbar</b> für 24" - 29"</li> <li>• spezielle Passform für Räder mit <b>Scheibenbremsen</b></li> <li>• mit Reflektor-/Rücklichthalter und Federklappe</li> <li>• Auflagefläche: 41 x 14 cm (L x B)</li> </ul>	<b>ALUMINIUM CARRIER ›DISC II‹</b> <ul style="list-style-type: none"> <li>• <b>adjustable</b> for 24" - 29"</li> <li>• special construction for bicycles with <b>disc brakes</b></li> <li>• with reflector/rear light bracket and spring flap</li> <li>• loading surface: 41 x 14 cm (L x W)</li> </ul>	 UVP 38,90 €
<b>440183</b>  <b>440184</b> 16	<b>ALUMINIUM-GEPÄCKTRÄGER ›TRAVELLER A I‹</b> <ul style="list-style-type: none"> <li>• <b>verstellbar</b> für 24" - 29"</li> <li>• besonders geeignet für <b>Gepäckträgertaschen</b></li> <li>• mit Reflektor-/Rücklichthalter und Federklappe</li> <li>• Auflagefläche: 37 x 13 cm (L x B)</li> </ul>	<b>ALUMINIUM CARRIER ›TRAVELLER A I‹</b> <ul style="list-style-type: none"> <li>• <b>adjustable</b> for 24" - 29"</li> <li>• specially suitable for <b>carrier bags</b></li> <li>• with reflector/rear light bracket and spring flap</li> <li>• loading surface: 37 x 13 cm (L x W)</li> </ul>	  UVP 45,90 €
<b>440174</b> 20	<b>ALUMINIUM-GEPÄCKTRÄGER ›ONE - 4 - ALL‹</b> <ul style="list-style-type: none"> <li>• <b>verstellbar</b> für 20" - 29"</li> <li>• besonders geeignet für <b>Rahmen mit schwierigen Befestigungsmöglichkeiten</b> (z. B. wegen Scheibenbremsaufnahme), da <b>Seitenstreben</b> in Neigung und Länge <b>einzel</b> <b>verstellbar</b> sind</li> <li>• mit Reflektor-/Rücklichthalter und Federklappe</li> <li>• mit <b>Universalbefestigungsset</b></li> <li>• mit <b>Nirosta</b>-Befestigungsmaterial</li> <li>• Auflagefläche: 39 x 14 cm (L x B)</li> <li>• mit M-Wave Eurolochkarte</li> </ul>	<b>ALUMINIUM CARRIER ›ONE - 4 - ALL‹</b> <ul style="list-style-type: none"> <li>• <b>adjustable</b> for 20" - 29"</li> <li>• specially suitable for <b>frames with difficult mounting facilities</b> (e. g. due to disc brake mounts), because the <b>side bars</b> are <b>individually adjustable</b> in length and tilt</li> <li>• with reflector/rear light bracket and spring flap</li> <li>• with <b>universal fitting set</b></li> <li>• with <b>stainless steel</b> mounting material</li> <li>• loading surface: 39 x 14 cm (L x W)</li> <li>• with M-Wave eurohole card</li> </ul>	  UVP 27,90 €

ART.-NR. 	BESCHREIBUNG	DESCRIPTION	
<p><b>440150</b></p> <p><b>440152</b></p> <p>20</p>	<p><b>ALUMINIUM-GEPÄCKTRÄGER ›ADJUST III‹</b></p> <ul style="list-style-type: none"> <li>• <b>verstellbar</b> für 26" - 29"</li> <li>• aus stabilem <b>Aluminium-Rundrohr</b></li> <li>• mit Reflektor-/Rücklichthalter und Federklappe</li> <li>• mit <b>Universalbefestigungsset</b></li> <li>• Auflagefläche: 33 x 12 cm (L x B)</li> </ul> <p>schwarz</p> <p>silber</p>	<p><b>ALUMINIUM CARRIER ›ADJUST III‹</b></p> <ul style="list-style-type: none"> <li>• <b>adjustable</b> for 26" - 29"</li> <li>• made of strong <b>aluminium tube</b></li> <li>• with reflector/rear light bracket and spring flap</li> <li>• with <b>universal fitting set</b></li> <li>• loading surface: 33 x 12 cm (L x W)</li> </ul> <p>black</p> <p>silver</p> <p><small>Tested by the manufacturer according to ISO 11243</small></p> <p>UVP 42,90 €</p>	
<p><b>440195</b></p> <p>12</p>	<p><b>ALUMINIUM-GEPÄCKTRÄGER ›TRAVELLER BASIC‹</b></p> <ul style="list-style-type: none"> <li>• <b>verstellbar</b> für 24" - 29"</li> <li>• mit Reflektor-/Rücklichthalter und Federklappe</li> <li>• <b>gemäß ISO 11243 mit 27 kg, 100.000 Belastungen</b></li> <li>• fest verschweißt</li> <li>• mit Pumpenspitzen</li> <li>• Auflagefläche: 41 x 13,5 cm (L x B)</li> </ul>	<p><b>ALUMINIUM CARRIER ›TRAVELLER BASIC‹</b></p> <ul style="list-style-type: none"> <li>• <b>adjustable</b> for 24" - 29"</li> <li>• with reflector/rear light bracket and spring flap</li> <li>• <b>according to ISO 11243 with 27 kg, 100,000 loads</b></li> <li>• welded</li> <li>• with pump pegs</li> <li>• loading surface: 41 x 13.5 cm (L x W)</li> </ul> <p><small>Tested by the manufacturer according to ISO 11243</small></p> <p>UVP 32,90 €</p>	<p><small>according to ISO 11243</small></p> <p><b>✓ 27 KG</b></p> <p><b>PUMP PEGS</b></p>
<p><b>440112</b></p> <p>20</p>	<p><b>ALUMINIUM-GEPÄCKTRÄGER ›SCREW - ON III‹</b></p> <ul style="list-style-type: none"> <li>• <b>verstellbar</b> für 24" - 29"</li> <li>• besonders geeignet für <b>Gepäckträgertaschen</b></li> <li>• mit Reflektor-/Rücklichthalter und Federklappe</li> <li>• mit <b>Bügeln</b> zur besseren Abstützung von Taschen</li> <li>• mit <b>Ösen</b> zur Befestigung einer <b>Mini-pumpe mit Halter</b> (z. B. Art. 470150)</li> <li>• maximale Traglast 25 kg</li> </ul>	<p><b>ALUMINIUM CARRIER ›SCREW - ON III‹</b></p> <ul style="list-style-type: none"> <li>• <b>adjustable</b> for 24" - 29"</li> <li>• specially suitable <b>for carrier bags</b></li> <li>• with reflector/rear light bracket and spring flap</li> <li>• with <b>brackets</b> for better support of bags</li> <li>• with <b>eyelets</b> for mounting a <b>mini pump with bracket</b> (e. g. art. 470150)</li> <li>• maximum loading capacity 25 kg</li> </ul> <p>UVP 32,90 €</p>	<p><b>PUMP BRACKET</b></p> <p><b>!</b></p>

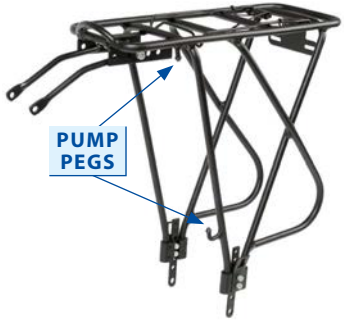



















ART.-NR. 	BESCHREIBUNG	DESCRIPTION	
<p>• <b>440198</b> 8</p>	<p><b>ALUMINIUM-GEPÄCKTRÄGER</b> ›TRAVELLER A II‹</p> <ul style="list-style-type: none"> <li>• <b>verstellbar</b> für 24" - 29"</li> <li>• mit Reflektor-/Rücklichthalter und Federklappe</li> <li>• <b>Korrosionsschutz</b> der Kleinteile durch <b>Dacromet-Beschichtung</b></li> <li>• mit Pumpenspitzen</li> <li>• Auflagefläche: 38 x 13 cm (L x B)</li> </ul>	<p><b>ALUMINIUM CARRIER</b> ›TRAVELLER A II‹</p> <ul style="list-style-type: none"> <li>• <b>adjustable</b> for 24" - 29"</li> <li>• with reflector/rear light bracket and spring flap</li> <li>• <b>rust protection</b> of small parts through <b>Dacromet coating</b></li> <li>• with pump pegs</li> <li>• loading surface: 38 x 13 cm (L x W)</li> </ul>	 <p>PUMP PEGS</p> <p>UVP 35,90 €</p>
<p><b>440196</b> 12</p>	<p><b>ALUMINIUM-GEPÄCKTRÄGER</b> ›THINY‹</p> <ul style="list-style-type: none"> <li>• <b>verstellbar</b> für 24" - 29"</li> <li>• <b>schmal und leicht:</b> Breite oben <b>85 - 110 mm</b></li> <li>• Gewicht nur <b>562 g</b></li> <li>• für Gepäckträgertaschen geeignet</li> <li>• mit Reflektor-/Rücklichthalter und Federklappe</li> <li>• mit <b>Universalbefestigungsset</b></li> <li>• mit <b>Edelstahl-Schrauben</b></li> <li>• Auflagefläche: 40 x 8,5/ 11 cm (L x B)</li> </ul>	<p><b>ALUMINIUM CARRIER</b> ›THINY‹</p> <ul style="list-style-type: none"> <li>• <b>adjustable</b> for 24" - 29"</li> <li>• <b>narrow and light:</b> upper width <b>85 - 110 mm</b></li> <li>• weight only <b>562 g</b></li> <li>• suitable for carrier bags</li> <li>• with reflector/rear light bracket and spring flap</li> <li>• with <b>universal fitting set</b></li> <li>• with <b>stainless steel screws</b></li> <li>• loading surface: 40 x 8,5/ 11 cm (L x W)</li> </ul>	 <p>562 g</p> <p>85 mm</p> <p>110 mm</p> <p>UVP 34,90 €</p>
<p><b>440158</b>  <b>440157</b> 20</p>	<p><b>ALUMINIUM-GEPÄCKTRÄGER</b> ›SCREW - ON II A‹</p> <ul style="list-style-type: none"> <li>• <b>verstellbar</b> für 24"/26"/28"</li> <li>• aus <b>4-kant Aluminium-Rohr</b></li> <li>• mit Reflektor-/Rücklichthalter und Federklappe</li> <li>• mit <b>Pumpenspitzen</b></li> <li>• mit <b>Universalbefestigungsset</b></li> <li>• kleines Verpackungs- und Präsentationsmaß (<b>Seitenteile abnehmbar</b>)</li> <li>• mit <b>Edelstahl-Schrauben</b></li> <li>• Auflagefläche: 37,5 x 13 cm (L x B)</li> <li>• in M-Wave <b>Blisterverpackung</b></li> </ul> <p>schwarz</p> <p>silber</p>	<p><b>ALUMINIUM CARRIER</b> ›SCREW - ON II A‹</p> <ul style="list-style-type: none"> <li>• <b>adjustable</b> for 24"/26"/28"</li> <li>• <b>square type aluminium tube</b></li> <li>• with reflector/rear light bracket and spring flap</li> <li>• with <b>pump pegs</b></li> <li>• with <b>universal fitting set</b></li> <li>• small packaging and presentation size (<b>side parts detachable</b>)</li> <li>• with <b>stainless steel screws</b></li> <li>• loading surface: 37.5 x 13 cm (L x W)</li> <li>• in M-Wave <b>blister packaging</b></li> </ul> <p>black</p> <p>silver</p>	 <p>PUMP PEGS</p> <p>M-WAVE</p> <p>UVP 27,90 €</p>
<p>• <b>440199</b> 8</p>	<p><b>ALUMINIUM-GEPÄCKTRÄGER</b> ›TRAVELLER A BASIC‹</p> <ul style="list-style-type: none"> <li>• für 26" und 28"</li> <li>• mit Reflektor-/Rücklichthalter und Federklappe</li> <li>• <b>Korrosionsschutz</b> der Keinteile durch <b>Dacromet-Beschichtung</b></li> <li>• Auflagefläche: 40 x 13 cm (L x B)</li> </ul>	<p><b>ALUMINIUM CARRIER</b> ›TRAVELLER A BASIC‹</p> <ul style="list-style-type: none"> <li>• for 26" and 28"</li> <li>• with reflector/rear light bracket and spring flap</li> <li>• <b>rust protection</b> of small parts through <b>Dacromet coating</b></li> <li>• loading surface: 40 x 13 cm (L x W)</li> </ul>	 <p>UVP 27,90 €</p>

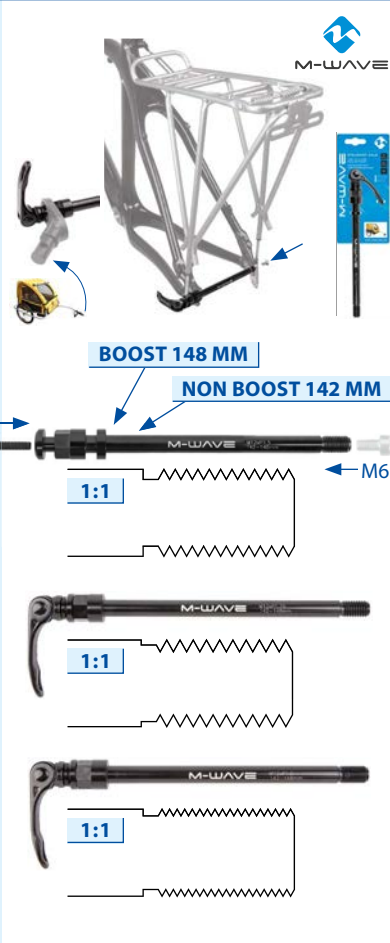

ART.-NR.	BESCHREIBUNG	DESCRIPTION	
440149 20	<b>UNIVERSAL STAHL-GEPÄCKTRÄGER</b> <b>›SCREW - ON II S‹</b> <ul style="list-style-type: none"> <li>• <b>verstellbar</b> für 26" und 28"</li> <li>• mit Reflektor-/Rücklichthalter und Federklappe</li> <li>• mit <b>Universalbefestigungsset</b></li> <li>• kleines Verpackungs- und Präsentationsmaß (<b>Seitenteile abnehmbar</b>)</li> <li>• Auflagefläche: 37 x 13 cm (L x B)</li> <li>• im Polybeutel mit Ventura <b>Euroloch-header</b></li> </ul>	<b>UNIVERSAL STEEL CARRIER</b> <b>›SCREW - ON II S‹</b> <ul style="list-style-type: none"> <li>• <b>adjustable</b> for 26" and 28"</li> <li>• with reflector/rear light bracket and spring flap</li> <li>• with <b>universal fitting set</b></li> <li>• small packaging and presentation size (<b>side parts detachable</b>)</li> <li>• loading surface: 37 x 13 cm (L x W)</li> <li>• in PE bag with Ventura <b>eurohole header</b></li> </ul>	<p>VENTURA BIKE + OUTDOOR</p> <p>26" + 28"</p> <p>UVP 14,90 €</p>
440162 25	<b>ALUMINIUM-GEPÄCKTRÄGER</b> <b>›SCREW-ON FLEX‹</b> <ul style="list-style-type: none"> <li>• zur Befestigung mit 4 Schrauben an der Sattelstütze Ø 25,0 - 31,8 mm</li> <li>• <b>verschiebbare Auflagefläche</b></li> <li>• <b>Befestigungspunkte für Spanngurte</b></li> <li>• maximale Traglast 10 kg</li> <li>• Auflagefläche: 33 x 12 cm (L x B)</li> </ul>	<b>ALUMINIUM CARRIER</b> <b>›SCREW ON FLEX‹</b> <ul style="list-style-type: none"> <li>• for fixing with 4 screws at the seat pillar Ø 25.0 - 31.8 mm</li> <li>• <b>shiftable loading surface</b></li> <li>• <b>attachment points for bungees</b></li> <li>• maximum loading capacity 10 kg</li> <li>• loading surface: 33 x 12 cm (L x W)</li> </ul>	<p>UVP 18,90 €</p>
440170 25	<b>ALUMINIUM-GEPÄCKTRÄGER</b> <b>›SP-QUICK‹</b> <ul style="list-style-type: none"> <li>• Ablage aus hochwertigem Kunststoff</li> <li>• mit Gummi-Gepäckgurten</li> <li>• mit <b>Schnellspanner</b>, zur Befestigung an der Sattelstütze</li> <li>• mit Ausgleichshülsen passend für Ø 25,0 - 31,8 mm</li> <li>• maximale Traglast 9 kg</li> <li>• Auflagefläche: ca. 31 x 13 cm (L x B)</li> </ul>	<b>ALUMINIUM CARRIER</b> <b>›SP-QUICK‹</b> <ul style="list-style-type: none"> <li>• rack made of high quality plastic</li> <li>• with rubber luggage straps</li> <li>• with <b>QR</b>, for fixing at the seat pillar</li> <li>• with adapter suitable for Ø 25.0 - 31.8 mm</li> <li>• maximum loading capacity 9 kg</li> <li>• loading surface: approx. 31 x 13 cm (L x W)</li> </ul>	<p>UVP 16,90 €</p>
440454 20	<b>MINI-GEPÄCKTRÄGER</b> <b>›MINI F + R‹</b> <ul style="list-style-type: none"> <li>• aus <b>Aluminium</b></li> <li>• universell einsetzbar für <b>vorne</b> oder <b>hinten</b></li> <li>• nur <b>254 g</b></li> <li>• Befestigung an den <b>Bremssockeln</b> und Gabelbrücke (vorne) oder Sitzstrebenbrücke/Pletscherplatte (hinten)</li> <li>• für 24" - 28"</li> <li>• mit <b>Nirostschrauben</b></li> <li>• mit Reflektorhalter</li> <li>• inkl. Befestigungsmaterial</li> <li>• Auflagefläche: 22 x 14 cm (L x B)</li> </ul>	<b>MINI PANNIER RACK</b> <b>›MINI F + R‹</b> <ul style="list-style-type: none"> <li>• made of <b>aluminium</b></li> <li>• universal fitting for <b>front</b> or <b>rear</b></li> <li>• only <b>254 g</b></li> <li>• for mounting at the <b>brake pivots</b> and fork crown (front) or seat stay bridge/Pletscher plate (rear)</li> <li>• for 24" - 28"</li> <li>• with <b>stainless steel</b> screws</li> <li>• with reflector bracket</li> <li>• incl. mounting material</li> <li>• loading surface: 22 x 14 cm (L x W)</li> </ul>	<p>M-WAVE</p> <p>2 IN 1</p> <p>FRONT + REAR</p> <p>UVP 16,90 €</p>
446103 30 <b>NEW</b>	<b>ALUMINIUM-GEPÄCKTRÄGER</b> <ul style="list-style-type: none"> <li>• für E-Bikes GEN2 und Urban Light MUC.T.al, MUC.L.al, MRC.G.al</li> <li>• für 28"</li> <li>• Breite: 93 mm, ohne Ladeplattform</li> <li>• max. Traglast 16 kg</li> <li>• Montage nur in Verbindung mit Schutzblech Art. 386230/1 möglich</li> </ul>	<b>ALUMINIUM CARRIER</b> <ul style="list-style-type: none"> <li>• for e-bikes GEN2 and Urban Light MUC.T.al, MUC.L.al, MRC.G.al</li> <li>• for 28"</li> <li>• width: 93 mm, without loading platform</li> <li>• maximum loading capacity 16 kg</li> <li>• mounting only possible in combination with mudguard art. 386230/1</li> </ul>	<p>UVP 44,99 €</p>
440466 20	<b>VORDERRAD-GEPÄCKTRÄGER</b> <ul style="list-style-type: none"> <li>• <b>Aluminium</b></li> <li>• zur <b>Anbringung von Vorderrad- und Seitentaschen</b></li> <li>• mit <b>Universalbefestigungsset</b></li> <li>• Montageverpackung</li> </ul>	<b>FRONT CARRIER</b> <ul style="list-style-type: none"> <li>• <b>aluminium</b></li> <li>• for <b>fitting front and side bags</b></li> <li>• with <b>universal fitting set</b></li> <li>• OEM</li> </ul>	<p>UVP 27,90 €</p>

ART.-NR. 	BESCHREIBUNG	DESCRIPTION	
<p><b>440451</b></p> <p><b>440458</b></p> <p>6</p>	<p><b>VORDERRAD-GEPÄCKTRÄGER</b></p> <ul style="list-style-type: none"> <li>• mit Lenkerhalter</li> <li>• <b>klappbar</b></li> <li>• Ladefläche ca. 30 x 30 cm</li> <li>• <b>stabile Ø 16 mm</b> Stahlrohre</li> <li>• mit Lampenhalter</li> <li>• Auflagefläche: 31 x 30 cm (L x B)</li> </ul> <p>mit hochwertigem <b>Buchenholz</b> „Made in Europe“, befestigt mit <b>Edelstahlschrauben</b></p> <p>aus Stahl</p>	<p><b>FRONT WHEEL CARRIER</b></p> <ul style="list-style-type: none"> <li>• with handlebar bracket</li> <li>• <b>foldable</b></li> <li>• load area approx. 30 x 30 cm</li> <li>• <b>stable Ø 16 mm</b> steel tubes</li> <li>• with lamp bracket</li> <li>• loading surface: 31 x 30 cm (L x W)</li> </ul> <p>with high-quality <b>beechwood</b> “made in Europe”, fixed with <b>stainless steel screws</b></p> <p>made of steel</p> <p>UVP 37,90 €</p> <p>UVP 28,90 €</p>	
<p><b>440455</b></p> <p>5</p>	<ul style="list-style-type: none"> <li>• mit hochwertigem <b>Buchenholz</b> „Made in Europe“</li> <li>• zur Montage am <b>Vorbau</b> oder <b>Steuersatzrohr</b></li> <li>• Ladefläche ca. 34 x 41 cm</li> <li>• <b>stabile Ø 16 mm</b> Stahlrohre</li> <li>• max. Zuladung 18 kg</li> <li>• Auflagefläche: 27 x 44 cm (L x B)</li> <li>• ideal für Weidenkorb Art. 431650, ...</li> </ul>	<ul style="list-style-type: none"> <li>• with high-quality <b>beechwood</b> “Made in Europe“</li> <li>• for mounting at <b>handle stem</b> or <b>head tube</b></li> <li>• load area approx. 34 x 41 cm</li> <li>• <b>stable Ø 16 mm</b> steel tubes</li> <li>• max. load 18 kg</li> <li>• loading surface: 27 x 44 cm (L x W)</li> <li>• ideal for wicker basket art. 431650, ...</li> </ul> <p>UVP 63,90 €</p>	
<p><b>449902</b></p> <p>25</p>	<p><b>GEPÄCKTRÄGERPLATTE</b> ›RACKY BASEPLATE‹</p> <ul style="list-style-type: none"> <li>• <b>Aluminium</b></li> <li>• Trägerplatte zur <b>Vergrößerung der Auflagefläche des Gepäckträgers</b></li> <li>• inkl. <b>3 Universalbefestigungsstreben</b></li> <li>• für alle gängigen Gepäckträger</li> <li>• 400 x 400 mm</li> <li>• mit M-Wave Banderole</li> </ul> 	<p><b>CARRIER PLATE</b> ›RACKY BASEPLATE‹</p> <ul style="list-style-type: none"> <li>• <b>aluminium</b></li> <li>• carrier plate for <b>enlarging the contact area of the carrier</b></li> <li>• incl. <b>3 universal</b> mounting struts</li> <li>• for all common carriers</li> <li>• 400 x 400 mm</li> <li>• with M-Wave banderole</li> </ul>  <p>UVP 19,90 €</p>	  
<p><b>440400</b></p> <p>25</p>	<p><b>UNIVERSELLER TASCHENHALTER</b> ›RACKY BAG‹</p> <ul style="list-style-type: none"> <li>• Aluminium</li> <li>• Anbringung an <b>allen gängigen Gepäckträgern</b> möglich</li> <li>• ermöglicht unkomplizierten <b>Transport von Rucksäcken, Einkaufstaschen, ...</b></li> <li>• mit Spanngurt zur Fixierung</li> <li>• nur 223 g</li> <li>• max. Zuladung 5 kg</li> <li>• mit M-Wave Banderole</li> </ul>  	<p><b>UNIVERSAL BAG HOLDER</b> ›RACKY BAG‹</p> <ul style="list-style-type: none"> <li>• aluminium</li> <li>• can be attached to <b>all common luggage racks</b></li> <li>• enables uncomplicated <b>transport of backpacks, shopping bags, ...</b></li> <li>• with tension belt for fixation</li> <li>• only 223 g</li> <li>• max. load 5 kg</li> <li>• with M-Wave banderole</li> </ul> <p>UVP 21,90 €</p>	  

ART.-NR.	BESCHREIBUNG	DESCRIPTION	
<p><b>440140</b></p> <p><b>440141</b></p> <p><b>440142</b></p> <p>50</p>	<p><b>STECKACHSE FÜR ANHÄNGER-KUPPLUNG</b>  <b>›STALWART AXLE‹</b></p> <ul style="list-style-type: none"> <li>durch Innengewinde auch zur <b>Montage von Gepäckträgern an Steckachsen</b> geeignet</li> <li>zur <b>werkzeuglosen Montage von Standard Fahrrad-Anhänger-Kupplungen</b> an <b>12 mm Steckachs-naben</b></li> <li><b>2 in 1:</b> durch 6 mm Distanzscheibe passend für 12 mm Steckachs-naben mit <b>142 mm Einbaumaß</b> und für <b>Boost-Naben mit 148 mm Einbaumaß</b></li> <li>Aluminium</li> <li>mit Schnellspanner</li> <li>auch <b>ohne Schnellspanner als saubere Lösung</b> für Steckachsen nutzbar</li> <li>mit zusätzlichem Innengewinde für M6-Schrauben, für z. B. Gepäckträgermontage</li> <li>mit zusätzlichen Unterlegscheiben zur <b>Einstellung der Schnellspannhebel-Position</b></li> <li>auf M-Wave Eurolochkarte</li> </ul> <p><b>Shimano Type</b>          (kein original Shimano Ersatzteil)          Gewindesteigung: P1.5 x T20</p> <p><b>Maxle Type</b>          (kein original Maxle Ersatzteil)          Gewindesteigung: P1.75 x T20</p> <p><b>Syntace Type</b>          (kein original Syntace Ersatzteil)          Gewindesteigung: P1.0 x T20          mit konischer Verbindungsscheibe</p>	<p><b>THRU AXLE FOR TRAILER MOUNT</b>  <b>›STALWART AXLE‹</b></p> <ul style="list-style-type: none"> <li>due to the internal thread also suitable for <b>mounting carriers to thru axles</b></li> <li>for <b>toolless mounting of standard bicycle trailer adapters at 12 mm thru axle hubs</b></li> <li><b>2 in 1:</b> by 6 mm spacer suitable for 12 mm thru axle hubs with OLD <b>142 mm</b> and for <b>boost hubs with OLD 148 mm</b></li> <li>aluminium</li> <li>with QR</li> <li>also usable <b>without QR as clean solution</b> for quick-release axle</li> <li>with additional internal thread for M6 screws for e. g. carrier assembly</li> <li>with additional spacers for <b>adjusting the QR lever position</b></li> <li>on M-Wave eurohole card</li> </ul> <p><b>Shimano Type</b>          (no original Shimano spare part)          thread pitch: P1.5 x T20</p> <p><b>Maxle Type</b>          (no original Maxle spare part)          thread pitch: P1.75 x T20</p> <p><b>Syntace Type</b>          (no original Syntace spare part)          thread pitch: P1.0 x T20          with conical spacer</p> <p>UVP 44,90 €</p>	 <p><b>BOOST 148 MM</b></p> <p><b>NON BOOST 142 MM</b></p> <p><b>1:1</b></p> <p><b>M6</b></p>
<p><b>440490</b></p> <p>100</p>	<p><b>SCHNELLSPANNER SET</b></p> <ul style="list-style-type: none"> <li>zur <b>Montage von Gepäckträgern an Rädern:</b></li> <li>- <b>ohne Befestigungsösen</b> (z. B. Rennräder)</li> <li>- mit <b>hinderlichen Sitzrohr- oder Kettenstreben, Ausfallenden, ...</b></li> <li>passend auch für <b>Fahrradanhänger</b> Art. 640050, ...</li> <li>mit 8 je 5 mm breiten <b>Adapter-scheiben</b></li> <li><b>Aluminiumhebel</b></li> <li>Länge 210 mm</li> <li>für Nabeneinbaumaß: <math>\geq 130</math> mm</li> <li><b>Einklembreite: 137 - 177 mm</b> (in 5 mm Schritten)</li> <li>auf M-Wave Eurolochkarte</li> </ul> 	<p><b>QUICK RELEASE SET</b></p> <ul style="list-style-type: none"> <li>for <b>mounting of carriers to bicycles:</b></li> <li>- <b>without mounting eyelets</b> (e. g. road bikes)</li> <li>- with <b>obstructive seat stays, chain stays, derailleur hangers, ...</b></li> <li>also suitable for <b>bicycle trailer</b> art. 640050, ...</li> <li>with <b>8 adapters</b>, each 5 mm wide</li> <li><b>aluminium lever</b></li> <li>length 210 mm</li> <li>OLD: <math>\geq 130</math> mm</li> <li><b>clamp width: 137 - 177 mm</b> (in 5 mm steps)</li> <li>on M-Wave eurohole card</li> </ul> <p>UVP 9,90 €</p>	 <p><b>137 - 177 mm</b></p>
<p><b>440101</b></p> <p><b>440104</b></p> <p>50 set</p>	<p><b>BEFESTIGUNGSSET</b></p> <ul style="list-style-type: none"> <li>U-Platte</li> <li><b>2 Kunststoff überzogene Klemmen</b></li> <li>2 Universaladapter</li> <li>Schrauben und Muttern</li> <li>Set im Polybeutel</li> </ul> <p><b>silber, 195 mm</b></p> <p><b>schwarz, 250 mm</b></p>	<p><b>MOUNTING SET</b></p> <ul style="list-style-type: none"> <li>u-plate</li> <li><b>2 plastic coated clamps</b></li> <li>2 universal adapters</li> <li>screws and nuts</li> <li>set in PE bag</li> </ul> <p><b>silver, 195 mm</b></p> <p><b>black, 250 mm</b></p> <p>UVP 4,90 €</p> <p>UVP 6,90 €</p>	 <p><b>XL</b></p>



# PUMPS







Art. 470329













ART.-NR.	BESCHREIBUNG	DESCRIPTION	
<b>470270</b> 50/25	<b>DÄMPFER- / MINI-PUMPE</b> <b>›DUAL FUNCTION 2 IN 1‹</b> <ul style="list-style-type: none"> <li>Aluminiumpumpe mit Kunststoffgriff</li> <li>als <b>Dämpferpumpe und Minipumpe</b> verwendbar</li> <li><b>umschaltbar von hohem Volumen auf hohen Druck</b></li> <li>Aluminium Pumpenkopf an klappbarem Schlauch</li> <li>mit <b>integriertem Manometer</b> und Druckablassknopf</li> <li>bis <b>21 bar / 300 psi</b></li> <li>mit Halter</li> <li>für FV, AV und DV</li> <li>auf Beto Eurolochkarte</li> </ul>	<b>SHOCK / MINI PUMP</b> <b>›DUAL FUNCTION 2 IN 1‹</b> <ul style="list-style-type: none"> <li>aluminium pump with plastic handle</li> <li>useable as <b>shock pump and mini pump</b></li> <li><b>switchable from high volume to high pressure</b></li> <li>aluminium pump head at foldable tube</li> <li>with <b>integrated manometer</b> and pressure release knob</li> <li>up to <b>21 bar / 300 psi</b></li> <li>with bracket</li> <li>for FV, AV and DV</li> <li>on Beto eurohole card</li> </ul>	<div style="text-align: center;">  </div> <div style="text-align: center;">  </div> 
<b>470275</b> 50/25	<b>DÄMPFERPUMPE</b> <ul style="list-style-type: none"> <li><b>Aluminium</b></li> <li><b>Hochleistungsmanometer</b> bis <b>28 bar / 400 psi</b></li> <li><b>(De-)Montage ohne Druckverlust</b></li> <li>Knopf für <b>kontrollierten Luftablass</b></li> <li>mit klappbarem, <b>flexiblem Schlauch</b>, dadurch <b>klein und handlich</b> auch für unterwegs</li> <li>für AV</li> <li>auf Beto Eurolochkarte</li> </ul>	<b>SHOCK PUMP</b> <ul style="list-style-type: none"> <li><b>aluminium</b></li> <li><b>top class manometer</b> up to <b>28 bar / 400 psi</b></li> <li><b>(de-)mounting w/o pressure release</b></li> <li>button for <b>controlled air release</b></li> <li>with foldable, <b>flexible tube</b>, <b>small and handy</b> also for en route use</li> <li>for AV</li> <li>on Beto eurohole card</li> </ul>	
<b>470361</b> 50/25	<b>MINI-PUMPE</b> <ul style="list-style-type: none"> <li><b>Aluminium</b></li> <li><b>CNC-gefräster Pumpenkopf</b></li> <li><b>Echtholz-T-Klappgriff</b> mit <b>Sicherheitsfunktion</b></li> <li>mit <b>Dreh-Schnellverschluss</b></li> <li>bis 8 bar / 120 psi</li> <li>für FV, AV und DV</li> <li>nur 82 g (ohne Halter), 257 mm</li> <li>mit Staubschutzkappe</li> <li>mit Halter</li> <li>auf Beto Eurolochkarte</li> </ul>	<b>MINI PUMP</b> <ul style="list-style-type: none"> <li><b>aluminium</b></li> <li><b>CNC machined pump head</b></li> <li><b>foldable wooden T-handle</b> with <b>safety function</b></li> <li>with <b>twist quick lock</b></li> <li>up to 8 bar / 120 psi</li> <li>for FV, AV and DV</li> <li>only 82 g (w/o bracket), 257 mm</li> <li>with dust protection cap</li> <li>with bracket</li> <li>on Beto eurohole card</li> </ul>	<div style="text-align: center;">  </div> 
<b>470359</b> 50/25	<b>MINI-PUMPE</b> <ul style="list-style-type: none"> <li><b>Aluminium</b>pumpe mit Kunststoffgriff</li> <li><b>CNC-gefräster Pumpenkopf</b> an <b>ausziehbarem Schlauch</b></li> <li>bis 11 bar / 160 psi</li> <li>für FV, AV und DV</li> <li>nur 94 g</li> <li>mit Halter und Sicherungsklettband</li> <li>auf Beto Eurolochkarte</li> </ul>	<b>MINI PUMP</b> <ul style="list-style-type: none"> <li><b>aluminium</b> pump with plastic handle</li> <li><b>CNC machined</b> pump head on <b>extendible tube</b></li> <li>up to 11 bar / 160 psi</li> <li>for FV, AV and DV</li> <li>only 94 g</li> <li>with bracket and safety hook and loop fastener</li> <li>on Beto eurohole card</li> </ul>	<div style="text-align: center;">  </div> 
<b>470360</b> 100	<b>MINI-PUMPE</b> <ul style="list-style-type: none"> <li><b>Aluminium</b></li> <li><b>CNC-gefräste Ventilaufnahme</b></li> <li><b>zwei Zylinder-Pumpentechnik</b> erhöht das <b>Pumpvolumen</b></li> <li>besonders kleines Taschen-Format</li> <li>bis 7 bar / 100 psi</li> <li>für FV</li> <li>nur <b>50 g</b> (ohne Halter), 158 mm</li> <li>mit Staubschutzkappe</li> <li>mit Halter und Sicherungsklettband</li> <li>auf Beto Eurolochkarte</li> </ul>	<b>MINI PUMP</b> <ul style="list-style-type: none"> <li><b>aluminium</b></li> <li><b>CNC machined valve port</b></li> <li><b>two barrel pumping technology</b> increases the <b>pumping volume</b></li> <li>especially small pocket-size</li> <li>up to 7 bar / 100 psi</li> <li>for FV</li> <li>only <b>50 g</b> (w/o bracket), 158 mm</li> <li>with dust protection cap</li> <li>with bracket and security hook and loop fastener</li> <li>on Beto eurohole card</li> </ul>	<div style="text-align: center;">  </div> <div style="text-align: center;">  </div> 

ART.-NR. 	BESCHREIBUNG	DESCRIPTION	
<b>470304</b> 100/25	<b>DOPPELKOPFPUMPE</b> <ul style="list-style-type: none"> <li>• <b>Aluminium</b></li> <li>• mit <b>Manometer</b> und <b>“Double Shot”-Funktion</b></li> <li>• bis 7 bar / 100 psi</li> <li>• mit <b>Universal-Doppelpumpenkopf</b> für AV, FV und DV</li> <li>• mit <b>rutschfestem Softgriff</b></li> <li>• mit Schnellverschlusshebel</li> <li>• mit Staubschutzkappe</li> <li>• mit Halter</li> <li>• auf Beto Eurolochkarte</li> </ul>	<b>DOUBLE HEAD PUMP</b> <ul style="list-style-type: none"> <li>• <b>aluminium</b></li> <li>• with <b>manometer</b> and <b>“Double Shot” function</b></li> <li>• up to 7 bar / 100 psi</li> <li>• with <b>universal double pump head</b> for AV, FV and DV</li> <li>• with <b>non-slip soft handle</b></li> <li>• with quick fastening lever</li> <li>• with dust protection cap</li> <li>• with bracket</li> <li>• on Beto eurohole card</li> </ul>	<p style="text-align: right;">UVP 10,90 €</p>
<b>470217</b> 100/25	<b>MINI-PUMPE</b> <ul style="list-style-type: none"> <li>• <b>Aluminium</b></li> <li>• mit <b>Dreh-Schnellverschluss</b></li> <li>• bis 5,5 bar / 80 psi</li> <li>• für FV, AV und DV</li> <li>• nur <b>67 g</b> (ohne Halter), 162 mm</li> <li>• mit Staubkappe</li> <li>• mit <b>Universal-Pumpenhalter</b></li> <li>• auf Beto Eurolochkarte</li> </ul>	<b>MINI PUMP</b> <ul style="list-style-type: none"> <li>• <b>aluminium</b></li> <li>• with <b>twist quick lock</b></li> <li>• up to 5.5 bar / 80 psi</li> <li>• for FV, AV and DV</li> <li>• only <b>67 g</b> (w/o bracket), 162 mm</li> <li>• with dust cap</li> <li>• with <b>universal pump bracket</b></li> <li>• on Beto eurohole card</li> </ul>	<p style="text-align: right;">UVP 7,90 €</p>
<b>470357</b> 100 <b>NEW</b>	<b>DOPPELKOPFPUMPE ›2 STAGES‹</b> <ul style="list-style-type: none"> <li>• <b>Aluminium</b></li> <li>• mit <b>Doppelfunktion</b> für <b>großes Volumen oder mehr Druck</b></li> <li>• bis 8 bar / 120 psi</li> <li>• <b>Universal-Doppelpumpenkopf</b> für FV und AV</li> <li>• mit Schnellverschlusshebel</li> <li>• mit Halter</li> <li>• auf Beto Eurolochkarte</li> </ul>	<b>DOUBLE HEAD PUMP ›2 STAGES‹</b> <ul style="list-style-type: none"> <li>• <b>aluminium</b></li> <li>• with <b>double function</b> for <b>high volume or more pressure</b></li> <li>• up to 8 bar / 120 psi</li> <li>• <b>universal double pump head</b> for FV and AV</li> <li>• with quick fastening lever</li> <li>• with bracket</li> <li>• on Beto eurohole card</li> </ul>	<p style="text-align: right;">UVP 10,90 €</p>
<b>470306</b> 100/25	<b>DOPPELKOPFPUMPE ›2 IN 1‹</b> <ul style="list-style-type: none"> <li>• mit <b>Doppelfunktion</b> für <b>großes Volumen oder mehr Druck</b></li> <li>• bis 8 bar / 120 psi</li> <li>• <b>Universal-Doppelpumpenkopf</b> für FV, AV und DV</li> <li>• mit <b>T-Klappgriff</b></li> <li>• mit Schnellverschlusshebel</li> <li>• mit Halter</li> <li>• auf Beto Eurolochkarte</li> </ul>	<b>DOUBLE HEAD PUMP ›2 IN 1‹</b> <ul style="list-style-type: none"> <li>• with <b>double function</b> for <b>high volume or more pressure</b></li> <li>• up to 8 bar / 120 psi</li> <li>• <b>universal double pump head</b> for FV, AV and DV</li> <li>• with <b>foldable T-handle</b></li> <li>• with quick fastening lever</li> <li>• with bracket</li> <li>• on Beto eurohole card</li> </ul>	<p style="text-align: right;">UVP 7,90 €</p>

ART.-NR.	BESCHREIBUNG	DESCRIPTION	
<p><b>470051</b></p> <p><b>470052</b></p> <p><b>470053</b> 50</p>	<p><b>DOPPELKOPF- RAHMENKLEMPPUMPE</b></p> <ul style="list-style-type: none"> <li>• <b>universell</b> für Montage zwischen Pumpenspitzen und Rahmenrohren</li> <li>• bis 8 bar / 120 psi</li> <li>• <b>Universal-Doppelpumpenkopf</b> für FV, AV und DV</li> <li>• mit Schnellverschlusshebel</li> <li>• mit Staubschutzkappe</li> <li>• auf Beto Eurolochkarte</li> </ul> <p>Klemmweite      414 - 480 mm (Rahmenhöhe ca.    48 - 54 cm)</p> <p>Klemmweite      460 - 530 mm (Rahmenhöhe ca.    54 - 58 cm)</p> <p>Klemmweite      514 - 580 mm (Rahmenhöhe ca.    58 - 62 cm)</p>	<p><b>DOUBLE HEAD FRAME PUMP</b></p> <ul style="list-style-type: none"> <li>• <b>universal</b> for fitting between pump hooks and frame tubes</li> <li>• up to 8 bar / 120 psi</li> <li>• <b>universal double pump head</b> for FV, AV and DV</li> <li>• with quick fastening lever</li> <li>• with dust protection cap</li> <li>• on Beto eurohole card</li> </ul> <p>clamp dist.      414 - 480 mm (frame height approx. 48 - 54 cm)</p> <p>clamp dist.      460 - 530 mm (frame height approx. 54 - 58 cm)</p> <p>clamp dist.      514 - 580 mm (frame height approx. 58 - 62 cm)</p> <p style="text-align: right;">UVP 7,90 €</p>	
<p><b>470364</b> 100/25</p>	<p><b>MINI-PUMPE</b></p> <ul style="list-style-type: none"> <li>• mit <b>beweglichem Kopf</b></li> <li>• bis 5,5 bar / 80 psi</li> <li>• für FV, AV und DV</li> <li>• mit <b>T-Klappgriff</b></li> <li>• mit Schnellverschlusshebel</li> <li>• mit Halter</li> <li>• auf Beto Eurolochkarte</li> </ul>	<p><b>MINI PUMP</b></p> <ul style="list-style-type: none"> <li>• with <b>swivel head</b></li> <li>• up to 5.5 bar / 80 psi</li> <li>• for FV, AV and DV</li> <li>• with <b>foldable T-handle</b></li> <li>• with quick fastening lever</li> <li>• with bracket</li> <li>• on Beto eurohole card</li> </ul> <p style="text-align: right;">UVP 6,90 €</p>	
<p><b>470226</b> 100/25</p>	<p><b>MINI-PUMPE ›DOUBLE-SHOT‹</b></p> <ul style="list-style-type: none"> <li>• „<b>Double-Shot</b>“-Funktion</li> <li>• bis 5,5 bar / 80 psi</li> <li>• für FV, AV und DV</li> <li>• nur <b>77 g</b> (ohne Nadel und Halter)</li> <li>• mit Schnellverschlusshebel</li> <li>• mit <b>Ballnadel</b></li> <li>• mit Halter</li> <li>• auf Beto Eurolochkarte</li> </ul>	<p><b>MINI PUMP ›DOUBLE-SHOT‹</b></p> <ul style="list-style-type: none"> <li>• „<b>Double Shot</b>“ function</li> <li>• up to 5.5 bar / 80 psi</li> <li>• for FV, AV and DV</li> <li>• only <b>77 g</b> (w/o needle and bracket)</li> <li>• with quick fastening lever</li> <li>• with <b>ball needle</b></li> <li>• with bracket</li> <li>• on Beto eurohole card</li> </ul> <p style="text-align: right;">UVP 5,90 €</p>	
<p><b>470358</b> 100</p> <p><b>NEW</b></p>	<p><b>MINI-PUMPE ›ONE WAY SP‹</b></p> <ul style="list-style-type: none"> <li>• Kunststoff</li> <li>• bis 5,5 bar / 80 psi</li> <li>• für FV und AV</li> <li>• mit Schnellverschlusshebel</li> <li>• mit Halter</li> <li>• auf Beto-Eurolochkarte</li> </ul>	<p><b>MINI PUMP ›ONE WAY SP‹</b></p> <ul style="list-style-type: none"> <li>• plastic</li> <li>• up to 5.5 bar / 80 psi</li> <li>• for FV and AV</li> <li>• with quick fastening lever</li> <li>• with bracket</li> <li>• on Beto eurohole card</li> </ul> <p style="text-align: right;">UVP 5,90 €</p>	

ART.-NR. 	BESCHREIBUNG	DESCRIPTION	
<b>470340</b> 12	<b>FUSS-STANDPUMPE</b> <ul style="list-style-type: none"> <li>hochwertiges <b>Spezialnylon</b></li> <li>klein, leicht, praktisch</li> <li><b>gummierte Non-Slip Trittfläche</b></li> <li>mit Haltebügel</li> <li>mit <b>großem Manometer</b></li> <li>bis 7 bar / 100 psi</li> <li><b>Universal-Doppelpumpenkopf</b> für FV, AV und DV</li> <li>mit Schnellverschlusshebel</li> <li>mit <b>langem (530 mm) Verlängerungsschlauch</b></li> <li>inkl. <b>Ballnadel</b> und <b>Luftmatratzenadapter</b></li> <li>auf Beto Eurolochkarte</li> </ul>	<b>FOOT PUMP</b> <ul style="list-style-type: none"> <li>high quality <b>special nylon</b></li> <li>small, light, handy</li> <li><b>non-slip rubber tread</b></li> <li>with retaining bracket</li> <li>with <b>big manometer</b></li> <li>up to 7 bar / 100 psi</li> <li><b>universal double pump head</b> for FV, AV and DV</li> <li>with quick fastening lever</li> <li>with <b>long (530 mm) extension tube</b></li> <li>incl. <b>ball needle</b> and <b>adapter for air beds</b></li> <li>on Beto eurohole card</li> </ul>	<p>UVP 19,90 €</p>
<b>470235</b> 50/25	<b>MINI-STANDPUMPE ›2 IN 1‹</b> <ul style="list-style-type: none"> <li><b>2 in 1:</b> im Handumdrehen wird aus der <b>Minipumpe</b> eine <b>Standpumpe</b></li> <li><b>Aluminium</b></li> <li>drehbarer, 18 cm langer Schlauch</li> <li><b>klappbarer T-Griff</b> mit Einklemmschutz</li> <li>bis 8 bar / 120 psi</li> <li>mit <b>Schnellverschlusshebel</b></li> <li>für FV, AV und DV</li> <li>mit Universalpumpenhalter</li> <li>auf Beto Eurolochkarte</li> </ul>	<b>MINI FLOOR PUMP ›2 IN 1‹</b> <ul style="list-style-type: none"> <li><b>2 in 1:</b> this <b>mini pump</b> can be turned into a <b>floor pump</b> within a second</li> <li><b>aluminium</b></li> <li>turnable, 18 cm long tube</li> <li><b>foldable T-handle</b> with pinch protection</li> <li>up to 8 bar / 120 psi</li> <li>with <b>quick fastening lever</b></li> <li>for FV, AV and DV</li> <li>with universal pump bracket</li> <li>on Beto eurohole card</li> </ul>	<p>UVP 14,90 €</p>
<b>470339</b> 4 <b>NEW</b>	<b>STANDPUMPE ›TUBELESS‹</b> <ul style="list-style-type: none"> <li>mit <b>Lufttank</b></li> <li>mit <b>Umschalthebel</b> für <b>sekundenschnelles Befüllen</b> oder normales Pumpen</li> <li>insbesondere für die Montage <b>schlauchloser Reifen</b> geeignet</li> <li>Aluminium</li> <li>bis <b>11 bar / 160 psi</b></li> <li><b>100 mm großes, flaches Manometer</b> für leichtes Ablesen</li> <li>mit <b>Universal-Pumpenkopf</b> für <b>FV, AV</b> und <b>DV</b></li> <li>Ballnadel und Luftmatratzenadapter im Griff</li> <li>mit Schnellverschlusshebel</li> <li>mit Beto Karte</li> </ul>	<b>FLOOR PUMP ›TUBELESS‹</b> <ul style="list-style-type: none"> <li>with <b>air tank</b></li> <li>with <b>kick switch</b> for <b>inflation within seconds</b> or normal pumping</li> <li>in particular suitable for <b>tubeless tires</b> mounting</li> <li>aluminium</li> <li>up to <b>11 bar / 160 psi</b></li> <li><b>100 mm large flat manometer</b> for easy reading</li> <li>with <b>universal pump head</b> for <b>FV, AV</b> and <b>DV</b></li> <li>ball needle and adapter for air beds in the handle</li> <li>with quick fastening lever</li> <li>with Beto tag</li> </ul>	<p>UVP 94,90 €</p>



ART.-NR.	BESCHREIBUNG	DESCRIPTION	
<b>470336</b> 4	<b>LUFTTANK</b> <ul style="list-style-type: none"> <li>• Hochdruck-Lufttank</li> <li>• sekundenschnelle Befüllung</li> <li>• insbesondere für die Montage <b>schlauchloser Reifen</b> geeignet</li> <li>• mit Überdruck-Sicherheitsventil</li> <li>• stabiler Fuß</li> <li>• bis <b>13 bar / 190 psi</b></li> <li>• mit <b>Universal-Pumpenkopf</b> für <b>FV, AV</b> und <b>DV</b></li> <li>• mit Schnellverschlusshebel</li> <li>• mit Beto Karte</li> </ul>	<b>AIR TANK</b> <ul style="list-style-type: none"> <li>• high pressure air tank</li> <li>• inflation within seconds</li> <li>• in particular suitable for <b>tubeless tires</b> mounting</li> <li>• with overpressure safety valve</li> <li>• stable base</li> <li>• up to <b>13 bar / 190 psi</b></li> <li>• with <b>universal pump head</b> for <b>FV, AV</b> and <b>DV</b></li> <li>• with quick fastening lever</li> <li>• with Beto tag</li> </ul>	   <p>2. release air</p> <p>1. fill tank</p> <p>UVP 74,90 €</p>
<b>470324</b> 10	<b>HOCHDRUCK-STANDPUMPE</b> <b>ALUMINIUMROHR IN TROPFENFORM</b> <ul style="list-style-type: none"> <li>• <b>Top Qualität</b></li> <li>• gummierter <b>Softgriff</b></li> <li>• <b>oben montiertes, großes Manometer</b></li> <li>• bis <b>11 bar / 160 psi</b></li> <li>• mit <b>Anti-Rutsch-Fußplatte</b></li> <li>• mit <b>Universal-Doppelpumpenkopf</b> für <b>FV, AV</b> und <b>optimierter Aufnahme für DV</b></li> <li>• mit <b>extra langem</b> Schlauch</li> <li>• mit Schnellverschlusshebel</li> <li>• mit Beto Karte</li> </ul>	<b>HIGH PRESSURE FLOOR PUMP</b> <b>DROP SHAPE ALUMINIUM BARREL</b> <ul style="list-style-type: none"> <li>• <b>top quality</b></li> <li>• rubber <b>soft grip</b></li> <li>• <b>big manometer mounted on top</b></li> <li>• up to <b>11 bar / 160 psi</b></li> <li>• with <b>non-slip</b> foot plate</li> <li>• with <b>universal double pump head</b> for <b>FV, AV</b> and <b>optimised vent for DV</b></li> <li>• with <b>extra long</b> tube</li> <li>• with quick fastening lever</li> <li>• with Beto tag</li> </ul>	  <p>UVP 47,90 €</p>
<b>470329</b> 10	<b>GROSSES, FLACHES, GUT LESBARES MANOMETER</b> <ul style="list-style-type: none"> <li>• bis <b>11 bar / 160 psi</b></li> <li>• sehr <b>stabile</b> Ausführung durch am <b>Standfuß verschweißtes Pumprohr</b></li> <li>• mit <b>Universal-Doppelpumpenkopf</b> für <b>FV, AV</b> und <b>optimierter Aufnahme für DV</b></li> <li>• mit Schnellverschlusshebel</li> <li>• mit Beto Karte</li> </ul>	<b>BIG, FLAT, WELL READABLE MANOMETER</b> <ul style="list-style-type: none"> <li>• up to <b>11 bar / 160 psi</b></li> <li>• very <b>firm</b> version through <b>welded-on pump tube at foot plate</b></li> <li>• with <b>universal double pump head</b> for <b>FV, AV</b> and <b>optimised vent for DV</b></li> <li>• with quick fastening lever</li> <li>• with Beto tag</li> </ul>	    <p>25 mm</p> <p>UVP 37,90 €</p>
<b>470325</b> 10	<b>OBEN MONTIERTES, GROSSES MANOMETER</b> <ul style="list-style-type: none"> <li>• <b>kontrollierbarer Luftablass</b></li> <li>• stabiler Standfuß</li> <li>• gummierter <b>Softgriff</b></li> <li>• bis <b>11 bar / 160 psi</b></li> <li>• mit <b>Universal-Doppelpumpenkopf</b> für <b>FV, AV</b> und <b>optimierter Aufnahme für DV</b></li> <li>• mit Schnellverschlusshebel</li> <li>• mit Beto Karte</li> </ul>	<b>BIG MANOMETER MOUNTED ON TOP</b> <ul style="list-style-type: none"> <li>• <b>controlled air release</b></li> <li>• solid foot plate</li> <li>• rubber <b>soft grip</b></li> <li>• up to <b>11 bar / 160 psi</b></li> <li>• with <b>universal double pump head</b> for <b>FV, AV</b> and <b>optimised vent for DV</b></li> <li>• with quick fastening lever</li> <li>• with Beto tag</li> </ul>	  <p>XL</p> <p>100 mm</p> <p>UVP 32,90 €</p>





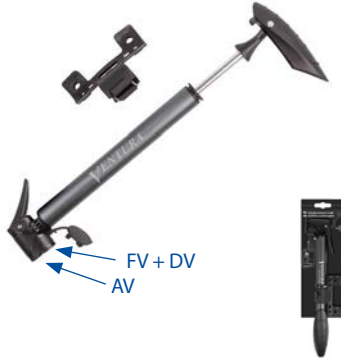
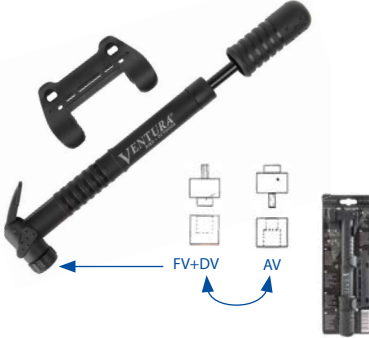
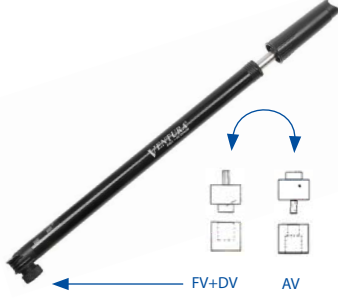

ART.-NR. 	BESCHREIBUNG	DESCRIPTION	
<p><b>470415</b> 15</p>	<p><b>ELEKTRISCHE PUMPE</b> ›ELUMATIK USB 2 / AP-117‹</p> <ul style="list-style-type: none"> <li>• <b>kleines, handliches Format</b></li> <li>• <b>Druck voreinstellbar</b></li> <li>• pumpt Schläuche, Bälle, Luftmatratzen,... <b>selbstständig</b> bis zum <b>voreingestellten Druck</b> auf und schaltet dann automatisch ab</li> <li>• <b>Lithium-Ionen-Akku</b></li> <li>• mit Micro USB Ladebuchse (Ladekabel enthalten)</li> <li>• <b>beleuchtetes LCD-Display</b></li> <li>• bis max. 150 psi / 10,3 bar</li> <li>• <b>Universal-Doppelpumpenkopf</b> für FV / AV / DV</li> <li>• inkl. <b>Ballnadel</b> und <b>Luftmatratzenadapter</b></li> <li>• mit integriertem <b>LED-Licht</b></li> <li>• mit wasserdichter Tasche, welche mit 3 Klettverschlüssen werkzeuglos am Oberrohr angebracht werden kann</li> <li>• in M-Wave Einzelkarton</li> </ul>	<p><b>ELECTRIC PUMP</b> ›ELUMATIK USB 2 / AP-117‹</p> <ul style="list-style-type: none"> <li>• <b>small and compact</b></li> <li>• <b>pressure presetting</b></li> <li>• pumps up tubes, balls, air beds,... <b>autonomously</b> up to the <b>default pressure</b> and turns off automatically afterwards</li> <li>• <b>Lithium Ion rechargeable battery</b></li> <li>• with <b>micro USB charging port</b> (charging cable included)</li> <li>• <b>illuminated LCD display</b></li> <li>• up to max. 150 psi / 10.3 bar</li> <li>• <b>universal double pump head</b> for FV / AV / DV</li> <li>• incl. <b>ball needle</b> and <b>adapter for air beds</b></li> <li>• with integrated <b>LED light</b></li> <li>• with waterproof bag, which can be toollessly mounted to the top tube by 3 hook and loop fasteners</li> <li>• in M-Wave box</li> </ul> <p style="text-align: right;">UVP 77,90 €</p>	 <p><b>WATERPROOF</b></p>
<p><b>470416</b> 10</p>	<p><b>KOMPRESSOR</b></p> <ul style="list-style-type: none"> <li>• bis <b>8 bar / 120 psi</b></li> <li>• mit <b>Manometer</b></li> <li>• <b>Universal-Doppelpumpenkopf</b> für <b>FV, AV</b> und <b>DV</b></li> <li>• 12 V Gleichstrom</li> <li>• mit <b>220 V</b> Stecker und <b>Netzteil</b></li> <li>• mit Adapter für Zigarettenanzünder</li> <li>• 16 x 13 x 7,5 cm</li> <li>• inkl. <b>Ballnadel</b> und <b>Luftmatratzenadapter</b></li> <li>• im Ventura Einzelkarton</li> </ul>	<p><b>COMPRESSOR</b></p> <ul style="list-style-type: none"> <li>• up to <b>8 bar / 120 psi</b></li> <li>• with <b>manometer</b></li> <li>• <b>universal double pump head</b> for <b>FV, AV</b> and <b>DV</b></li> <li>• 12 V DC</li> <li>• with <b>220 V</b> plug and <b>power supply</b></li> <li>• with adapter for cigarette lighter</li> <li>• 16 x 13 x 7.5 cm</li> <li>• incl. <b>ball needle</b> and <b>adapter for air beds</b></li> <li>• in Ventura box</li> </ul> <p style="text-align: right;">UVP 59,90 €</p>	 <p><b>VENTURA</b> BIKE + OUTDOOR</p>
<p><b>470207</b> 50</p>	<p><b>MINI-PUMPE</b></p> <ul style="list-style-type: none"> <li>• <b>Carbon/Titan</b></li> <li>• bis 10 bar / 142 psi</li> <li>• für FV und DV</li> <li>• nur <b>29 g</b></li> <li>• nur <b>139 mm</b></li> <li>• mit <b>Befestigungsclips</b></li> <li>• in Blisterverpackung</li> </ul>	<p><b>MINI PUMP</b></p> <ul style="list-style-type: none"> <li>• <b>carbon/titanium</b></li> <li>• up to 10 bar / 142 psi</li> <li>• for FV and DV</li> <li>• only <b>29 g</b></li> <li>• only <b>139 mm</b></li> <li>• with <b>mounting clips</b></li> <li>• in blister packaging</li> </ul> <p style="text-align: right;">UVP 32,90 €</p>	 <p><b>LEICHTESTE PUMPE DER WELT</b></p> <p><b>29 g</b></p> <p><b>CARBON</b></p> <p><b>TITAN</b></p> <p>139 mm</p>
<p><b>470267</b> 100</p>	<p><b>MINI-PUMPE</b></p> <ul style="list-style-type: none"> <li>• aus <b>Aluminium</b></li> <li>• bis 7 bar / 100 psi</li> <li>• für FV und DV (mit Ventiladapter für AV)</li> <li>• nur <b>49 g</b></li> <li>• nur <b>99 mm</b></li> <li>• mit Halter</li> <li>• in Eurolochbox</li> </ul>	<p><b>MINI PUMP</b></p> <ul style="list-style-type: none"> <li>• made of <b>aluminium</b></li> <li>• up to 7 bar / 100 psi</li> <li>• for FV and DV (with valve adapter for AV)</li> <li>• only <b>49 g</b></li> <li>• only <b>99 mm</b></li> <li>• with bracket</li> <li>• in eurohole box</li> </ul> <p style="text-align: right;">UVP 29,90 €</p>	 <p><b>49 g</b></p> <p>99 mm</p>

ART.-NR. 	BESCHREIBUNG	DESCRIPTION	
<b>470281</b> 125	<b>MINI-PUMPE ›MINIATAIR‹</b> <ul style="list-style-type: none"> <li>• CNC-gefrästes <b>Aluminium</b></li> <li>• bis 6,2 bar / 90 psi</li> <li>• für FV, AV und DV</li> <li>• nur <b>68 g</b></li> <li>• nur <b>120 mm</b></li> <li>• mit Halter und Gummibandbefestigung</li> <li>• auf M-Wave Eurolochkarte</li> </ul>	<b>MINI PUMP ›MINIATAIR‹</b> <ul style="list-style-type: none"> <li>• CNC machined <b>aluminium</b></li> <li>• up to 6.2 bar / 90 psi</li> <li>• for FV, AV and DV</li> <li>• only <b>68 g</b></li> <li>• only <b>120 mm</b></li> <li>• with bracket and rubber strap</li> <li>• on M-Wave eurohole card</li> </ul>	      <p>UVP 17,90 €</p>
<b>470337</b> 100/25	<b>DOPPELKOPFPUMPE ›DOUBLE SHOT B‹</b> <ul style="list-style-type: none"> <li>• <b>Aluminium</b></li> <li>• bis 8,5 bar / 120 psi</li> <li>• mit <b>Universal-Doppelpumpenkopf</b> für AV, FV und DV</li> <li>• mit <b>Schnellverschluss</b></li> <li>• mit Staubschutzkappe</li> <li>• mit <b>Manometer</b> und <b>“Double Shot“-Funktion</b></li> <li>• mit <b>rutschfestem Softgriff</b></li> <li>• mit Halter</li> <li>• auf M-Wave Eurolochkarte</li> </ul>	<b>DOUBLE HEAD PUMP ›DOUBLE SHOT B‹</b> <ul style="list-style-type: none"> <li>• <b>aluminium</b></li> <li>• up to 8.5 bar / 120 psi</li> <li>• with <b>universal double pump head</b> for AV, FV and DV</li> <li>• with <b>quick fastening lever</b></li> <li>• with dust protection cap</li> <li>• with <b>manometer</b> and <b>“Double Shot“-function</b></li> <li>• with <b>non-slip soft handle</b></li> <li>• with bracket</li> <li>• on M-Wave eurohole card</li> </ul>	    <p>UVP 11,90 €</p>
<b>470218</b> 100/25	<b>MINI-PUMPE</b> <ul style="list-style-type: none"> <li>• <b>Aluminium</b></li> <li>• bis <b>8 bar / 120 psi</b></li> <li>• für FV, AV und DV</li> <li>• nur <b>83 g, 175 mm</b></li> <li>• mit Staubschutzkappe</li> <li>• mit <b>Schnellverschluss</b></li> <li>• mit Klettbandfixierung</li> <li>• mit rutschfestem <b>Softgriff</b></li> <li>• mit Halter</li> <li>• auf <b>Giyo</b> Eurolochkarte</li> </ul>	<b>MINI PUMP</b> <ul style="list-style-type: none"> <li>• <b>aluminium</b></li> <li>• up to <b>8 bar / 120 psi</b></li> <li>• for FV, AV and DV</li> <li>• only <b>83 g, 175 mm</b></li> <li>• with dust protection cap</li> <li>• with <b>quick fastening lever</b></li> <li>• with hook and loop tape</li> <li>• with <b>non-slip soft handle</b></li> <li>• with bracket</li> <li>• on <b>Giyo</b> eurohole card</li> </ul>	    <p>UVP 10,90 €</p>
<b>470280</b> 100/25 <b>TIP</b>	<b>MINI-PUMPE ›FLEXI TUBE‹</b> <ul style="list-style-type: none"> <li>• <b>Aluminiumpumpe</b></li> <li>• für FV, AV und DV</li> <li>• nur <b>89 g</b></li> <li>• mit <b>herausnehmbarem, 150 mm langen Schlauch</b></li> <li>• mit Staubschutzkappe</li> <li>• mit Halter und Sicherungsband</li> <li>• auf M-Wave Eurolochkarte</li> </ul>	<b>MINI PUMP ›FLEXI TUBE‹</b> <ul style="list-style-type: none"> <li>• <b>aluminium pump</b></li> <li>• for FV, AV and DV</li> <li>• only <b>89 g</b></li> <li>• with <b>removable, 150 mm long tube</b></li> <li>• with dust protection cap</li> <li>• with bracket and safety strap</li> <li>• on M-Wave eurohole card</li> </ul>	    <p>UVP 8,90 €</p>



ART.-NR.	BESCHREIBUNG	DESCRIPTION	
<p><b>470233</b></p> <p>100/20</p>	<p><b>DOPPELKOPFPUMPE</b></p> <ul style="list-style-type: none"> <li>• <b>Aluminium</b></li> <li>• <b>Universal-Doppelpumpenkopf</b> für <b>FV, AV</b> und <b>DV</b></li> <li>• mit <b>Schnellverschlusshebel</b></li> <li>• <b>Teleskop</b></li> <li>• mit <b>T-Klappgriff</b></li> <li>• mit Halter</li> <li>• auf Ventura Eurolochkarte</li> </ul>	<p><b>DOUBLE HEAD PUMP</b></p> <ul style="list-style-type: none"> <li>• <b>aluminium</b></li> <li>• <b>universal double pump head</b> for <b>FV, AV</b> and <b>DV</b></li> <li>• with <b>quick fastening lever</b></li> <li>• <b>telescope</b></li> <li>• with <b>foldable T-handle</b></li> <li>• with bracket</li> <li>• on Ventura eurohole card</li> </ul>	<p><b>VENTURA®</b> BIKE + OUTDOOR</p>  <p>UVP 6,90 €</p>
<p><b>470157</b></p> <p>32</p>	<p><b>MINI-PUMPE</b></p> <ul style="list-style-type: none"> <li>• <b>Aluminium</b></li> <li>• <b>titanfarben eloxiert</b></li> <li>• <b>Universal-Doppelpumpenkopf</b> für <b>FV, AV</b> und <b>DV</b></li> <li>• mit <b>Schnellverschlusshebel</b></li> <li>• mit Staubschutzkappe</li> <li>• mit <b>T-Klappgriff</b></li> <li>• mit Halter</li> <li>• auf Ventura Eurolochkarte</li> </ul>	<p><b>MINI-PUMP</b></p> <ul style="list-style-type: none"> <li>• <b>aluminium</b></li> <li>• <b>titanium anodized colour</b></li> <li>• <b>universal double pump head</b> for <b>FV, AV</b> and <b>DV</b></li> <li>• with <b>quick fastening lever</b></li> <li>• with dust protection cap</li> <li>• with <b>foldable T-handle</b></li> <li>• with bracket</li> <li>• on Ventura eurohole card</li> </ul>	<p><b>VENTURA®</b> BIKE + OUTDOOR</p>  <p>UVP 4,90 €</p>
<p><b>470150</b></p> <p>100/10</p>	<p><b>MINI-PUMPE</b></p> <ul style="list-style-type: none"> <li>• <b>Kunststoff</b></li> <li>• für <b>FV, AV</b> und <b>DV</b></li> <li>• mit <b>Schnellverschlusshebel</b></li> <li>• mit Halter</li> <li>• auf Ventura Eurolochkarte</li> </ul>	<p><b>MINI PUMP</b></p> <ul style="list-style-type: none"> <li>• <b>plastic</b></li> <li>• for <b>FV, AV</b> and <b>DV</b></li> <li>• with <b>quick fastening lever</b></li> <li>• with bracket</li> <li>• on Ventura eurohole card</li> </ul>	<p><b>VENTURA®</b> BIKE + OUTDOOR</p>  <p>UVP 4,90 €</p>
<p><b>470042</b></p> <p><b>470043</b></p> <p><b>470044</b></p> <p>100</p>	<p><b>RAHMENKLEMPPUMPE</b></p> <ul style="list-style-type: none"> <li>• <b>universell passend</b> für Montage zwischen Pumpenspitzen und Rahmenrohren</li> <li>• für <b>FV, AV</b> und <b>DV</b></li> <li>• mit <b>Feder</b></li> <li>• Montageverpackung</li> </ul> <p>Klemmweite      415 - 445 mm (Rahmenhöhe ca.    48 - 53 cm)</p> <p>Klemmweite      455 - 485 mm (Rahmenhöhe ca.    54 - 57 cm)</p> <p>Klemmweite      500 - 530 mm (Rahmenhöhe ca.    58 - 61 cm)</p>	<p><b>FRAME PUMP</b></p> <ul style="list-style-type: none"> <li>• <b>universally fitting</b> for mounting between pump hooks and frame tubes</li> <li>• for <b>FV, AV</b> and <b>DV</b></li> <li>• with <b>spring</b></li> <li>• <b>OEM</b></li> </ul> <p>clamp dist.            415 - 445 mm (frame height approx. 48 - 53 cm)</p> <p>clamp dist.            455 - 485 mm (frame height approx. 54 - 57 cm)</p> <p>clamp dist.            500 - 530 mm (frame height approx. 58 - 61 cm)</p>	<p><b>VENTURA®</b> BIKE + OUTDOOR</p>  <p>UVP 2,90 €</p>

ART.-NR. 	BESCHREIBUNG	DESCRIPTION	
<b>470335</b> 6	<b>STANDPUMPE ›AIR BULLET‹</b> <ul style="list-style-type: none"> <li>Aluminium</li> <li><b>sekundenschnelle Befüllung</b> oder normal pumpen</li> <li>insbesondere für die Montage <b>schlauchloser Reifen</b> geeignet</li> <li>bis <b>18 bar / 260 psi</b></li> <li>extra <b>langer Pumpenschlauch</b></li> <li>mit <b>Universal-Pumpenkopf</b> für <b>FV, AV</b> und <b>DV</b></li> <li>mit <b>Lufttank</b></li> <li>Manometer an der Oberseite für leichtes Ablesen</li> <li>stabiler Fuß mit Anti-Rutsch-Einlage</li> <li>mit M-Wave Karte</li> </ul>	<b>FLOOR PUMP ›AIR BULLET‹</b> <ul style="list-style-type: none"> <li>aluminium</li> <li><b>inflation within seconds</b> or normal pumping</li> <li>in particular suitable for <b>tubeless tires</b> mounting</li> <li>up to <b>18 bar / 260 psi</b></li> <li>extra <b>long pump tube</b></li> <li><b>universal pump head</b> for <b>FV, AV</b> and <b>DV</b></li> <li>with <b>air tank</b></li> <li>top-mounted manometer for easy reading</li> <li>stable base with non-slip pad</li> <li>with M-Wave tag <span style="float: right;">UVP 145,00 €</span></li> </ul> 	<div style="display: flex; justify-content: space-between;"> <span>tubeless ✓</span>  </div> 
<b>470531</b> 10	<b>STANDPUMPE ›AIR FLOW‹</b> <ul style="list-style-type: none"> <li>poliertes <b>Aluminium</b></li> <li>bis <b>10 bar / 145 psi</b></li> <li>mit <b>Universal-Pumpenkopf</b> für <b>FV, AV</b> und <b>DV</b></li> <li>extra <b>langer Pumpenschlauch</b></li> <li>mit Schnellverschlusshebel</li> <li>großes, flaches, gut lesbares Manometer</li> <li>Ballnadel und Luftmatratzenadapter</li> <li>mit M-Wave Karte</li> </ul>	<b>FLOOR PUMP ›AIR FLOW‹</b> <ul style="list-style-type: none"> <li>polished <b>aluminium</b></li> <li>up to <b>10 bar / 145 psi</b></li> <li><b>universal pump head</b> for <b>FV, AV</b> and <b>DV</b></li> <li>extra <b>long pump tube</b></li> <li>with quick fastening lever</li> <li>big, flat, well readable manometer</li> <li>ball needle and adapter for air beds</li> <li>with M-Wave tag</li> </ul> <span style="float: right;">UVP 39,90 €</span>	 
<b>470375</b> 10 <b>TIP</b>	<b>STANDPUMPE ›AIR JET‹</b> <ul style="list-style-type: none"> <li>bis <b>11 bar / 160 psi</b></li> <li>mit <b>Universal-Pumpenkopf</b> für <b>FV, AV</b> und <b>DV</b></li> <li><b>extra großes, gut lesbares Manometer</b></li> <li><b>Non-Slip</b> Zweikomponentengriff</li> <li>stabiler Fuß</li> <li>mit M-Wave Karte</li> </ul>	<b>FLOOR PUMP ›AIR JET‹</b> <ul style="list-style-type: none"> <li>up to <b>11 bar / 160 psi</b></li> <li><b>universal pump head</b> for <b>FV, AV</b> and <b>DV</b></li> <li><b>extra big, well readable manometer</b></li> <li><b>non-slip</b> 2-component handle</li> <li>stable base</li> <li>with M-Wave tag</li> </ul> <span style="float: right;">UVP 28,90 €</span>	 
<b>470378</b> 10	<b>STANDPUMPE</b> <ul style="list-style-type: none"> <li>Stahl</li> <li>mit <b>Universal-Doppelpumpenkopf</b> für <b>FV, AV</b> und <b>DV</b></li> <li>mit Schnellverschlusshebel</li> <li><b>Ballnadel</b> und Luftmatratzenadapter</li> <li>mit höherliegendem <b>Manometer</b></li> <li>mit Ventura Karte</li> </ul>	<b>FLOOR PUMP</b> <ul style="list-style-type: none"> <li>steel</li> <li>with <b>universal double pump head</b> for <b>FV, AV</b> and <b>DV</b></li> <li>with quick fastening lever</li> <li><b>ball needle</b> and adapter for air beds</li> <li>with higher arranged <b>manometer</b></li> <li>with Ventura tag</li> </ul> <span style="float: right;">UVP 19,90 €</span>	 

ART.-NR. 	BESCHREIBUNG	DESCRIPTION	
<p><b>470505</b></p> <p>8</p> <p><b>NEW</b></p>	<p><b>STANDPUMPE</b></p> <ul style="list-style-type: none"> <li>• Stahl</li> <li>• bis <b>8 bar / 120 psi</b></li> <li>• mit <b>Universal-Doppelpumpenkopf</b> für <b>FV, AV</b> und <b>DV</b></li> <li>• mit Schnellverschlusshebel</li> <li>• mit <b>großem, gut ablesbarem Manometer</b></li> <li>• Ballnadel und Luftmatratzenadapter</li> <li>• mit Ventura Karte</li> </ul>	<p><b>FLOOR PUMP</b></p> <ul style="list-style-type: none"> <li>• steel</li> <li>• up to <b>8 bar / 120 psi</b></li> <li>• with <b>universal double pump head</b> for <b>FV, AV</b> and <b>DV</b></li> <li>• with quick fastening lever</li> <li>• with <b>big, well readable manometer</b></li> <li>• ball needle and adapter for air beds</li> <li>• with Ventura tag</li> </ul>	<p></p> <p><b>VENTURA®</b> BIKE + OUTDOOR</p> <p>UVP 22,90 €</p>
<p><b>470377</b></p> <p>20</p>	<p><b>STANDPUMPE</b></p> <ul style="list-style-type: none"> <li>• Stahl</li> <li>• mit <b>Universal-Doppelpumpenkopf</b> für <b>FV, AV</b> und <b>DV</b></li> <li>• mit Schnellverschlusshebel</li> <li>• <b>Ballnadel</b> und Luftmatratzenadapter</li> <li>• mit <b>höherliegendem Manometer</b> für bessere Ablesbarkeit</li> <li>• mit Ventura Karte</li> </ul>	<p><b>FLOOR PUMP</b></p> <ul style="list-style-type: none"> <li>• steel</li> <li>• with <b>universal double pump head</b> for <b>FV, AV</b> and <b>DV</b></li> <li>• with quick fastening lever</li> <li>• <b>ball needle</b> and adapter for air beds</li> <li>• with <b>higher arranged manometer</b> for better readability</li> <li>• with Ventura tag</li> </ul>	<p></p> <p><b>VENTURA®</b> BIKE + OUTDOOR</p> <p>UVP 11,90 €</p>
<p><b>470328</b></p> <p>20</p>	<p><b>STANDPUMPE CLASSIC</b></p> <ul style="list-style-type: none"> <li>• Kunststoff</li> <li>• für AV, mit <b>Ventiladapter</b> für FV und DV</li> <li>• mit <b>Schnellverschlusshebel</b></li> <li>• mit <b>Feder</b></li> <li>• schwarz</li> </ul>	<p><b>FLOOR PUMP CLASSIC</b></p> <ul style="list-style-type: none"> <li>• plastic</li> <li>• for AV, with <b>valve adapter</b> for FV and DV</li> <li>• with <b>quick fastening lever</b></li> <li>• with <b>spring</b></li> <li>• black</li> </ul>	<p></p> <p>UVP 6,90 €</p>
<p><b>470344</b></p> <p>10</p>	<p><b>FUSSPUMPE</b> &gt;CLASSIC BASE POWER&lt;</p> <ul style="list-style-type: none"> <li>• Stahl</li> <li>• bis <b>7 bar / 100 psi</b></li> <li>• mit <b>Universal-Doppelpumpenkopf</b> für <b>FV, AV</b> und <b>DV</b></li> <li>• mit <b>langem Schlauch: 540 mm</b></li> <li>• mit <b>Schnellverschlusshebel</b></li> <li>• Zylinder 55 x 100 mm</li> <li>• mit <b>Manometer</b></li> <li>• mit <b>Ballnadel</b> und <b>Luftmatratzenadapter</b></li> <li>• im Polybeutel</li> </ul>	<p><b>FOOT PUMP</b> &gt;CLASSIC BASE POWER&lt;</p> <ul style="list-style-type: none"> <li>• steel</li> <li>• up to <b>7 bar / 100 psi</b></li> <li>• with <b>universal double pump head</b> for <b>FV, AV</b> and <b>DV</b></li> <li>• with <b>long tube: 540 m</b></li> <li>• with <b>quick fastening lever</b></li> <li>• cylinder 55 x 100 mm</li> <li>• with <b>manometer</b></li> <li>• with <b>ball needle</b> and <b>adapter for air beds</b></li> <li>• in PE bag</li> </ul>	<p></p> <p><i>Classic</i></p> <p>UVP 11,90 €</p>

ART.-NR. 	BESCHREIBUNG	DESCRIPTION	
<b>470246</b> 100	<b>ERSATZ-DOPPELPUMPENKOPF</b>  • <b>Universal-Doppelpumpenkopf</b> (für FV, AV und DV) • Montageverpackung	<b>REPLACEMENT DOUBLE PUMP HEAD</b>  • <b>universal double pump head</b> (for FV, AV and DV) • OEM	 UVP 2,90 €
<b>470285</b> 200/50	• mit <b>Universal-Doppelpumpenkopf</b> (für FV, AV und DV) • <b>600 mm Schlauch</b> • mit Anschlussgewinde für AV (Mini-) Pumpe	• with <b>universal double pump head</b> (for FV, AV and DV) • <b>600 mm tube</b> • with threaded connection for AV (mini) pump	 UVP 3,90 €
<b>470173</b> 100/50 set	<b>CO2-PUMPE</b>  • <b>wiederverschließbar</b> und <b>dosierbar</b> • passt für FV, AV und DV • mit wiederverwendbarer <b>Kälteschutzummantelung</b> • auf Eurolochkarte	<b>CO2 PUMP</b>  • <b>reclosable</b> and <b>controllable</b> • fits for FV, AV and DV • with reusable <b>cold protection layer</b> • on eurohole card	
<b>470169</b> 100/50	ohne Patrone	w/o cartridge	UVP 8,90 €
<b>NICE PRICE</b>	<b>CO2-PATRONE</b> mit 3/8" Gewinde	<b>CO2 CARTRIDGE</b> with 3/8" thread	
<b>470186</b> 100 set	<b>16 g</b> 2 Stück in M-Wave Eurolochbox	<b>16 g</b> 2 pieces in M-Wave eurohole box	UVP 4,90 €
<b>470168</b> 300/10	im 10er Einzelkarton	10 pieces in box	UVP 2,10 €
<b>470183</b> 200/20	• <b>25 g</b> • im 20er Einzelkarton	• <b>25 g</b> • 20 pieces in box	<b>XL 25 g</b>  UVP 4,90 €
<b>470288</b> 50	<b>DÄMPFERPUMPE</b>  • Aluminium • <b>Hochleistungsmanometer</b> bis <b>21 bar / 300 psi</b> • für AV • Knopf für <b>kontrollierten Luftablass</b> • <b>(De-)Montage ohne Druckverlust</b> • mit klappbarem, <b>flexiblem Schlauch</b> , dadurch <b>klein und handlich</b> auch für unterwegs • auf <b>Giyo</b> Eurolochkarte	<b>SHOCK PUMP</b>  • aluminium • <b>top class manometer</b> up to <b>21 bar / 300 psi</b> • for AV • button for <b>controlled air release</b> • <b>(de-)mounting w/o pressure release</b> • with foldable, <b>flexible tube</b> , thereby <b>small and handy</b> , also for en route use • on <b>Giyo</b> eurohole card	 UVP 48,90 €
<b>470276</b> 30/10	• <b>Aluminiumgriff</b> • Schlauch nicht klappbar	• <b>aluminium handle</b> • no folding tube	 UVP 44,90 €
<b>479982</b> 4.000/25	<b>BALLNADEL</b> passend für alle gängigen Pumpen, Montageverpackung	<b>BALL NEEDLE</b> suitable for all normal pumps, OEM	 UVP 0,49 €





# VALVES PUNCTURE PROTECTION



ART.-NR.	BESCHREIBUNG	DESCRIPTION	
	<b>ALUMINIUM-VENTILVERLÄNGERUNG</b>	<b>ALUMINIUM VALVE EXTENSION</b>	
<b>519947</b> 300/20 set	<ul style="list-style-type: none"> <li>für FV</li> <li>zur Verwendung in Hochprofilfelgen</li> <li>paarweise auf M-Wave Eurolochkarte</li> </ul> <ul style="list-style-type: none"> <li>verlängert das Ventil um <b>50 mm</b></li> <li><b>gedichtet</b></li> <li>für FV mit heraus-schraubbarem Ventileinsatz</li> <li>mit Werkzeug zum Heraus-schrauben des Ventileinsatzes</li> <li>schwarz</li> </ul>	<ul style="list-style-type: none"> <li>for FV</li> <li>for using with high profil rims</li> <li>one pair on M-Wave eurohole card</li> </ul> <ul style="list-style-type: none"> <li>prolongs the valve by <b>50 mm</b></li> <li><b>sealed</b></li> <li>for FV with removable valve insert</li> <li>with tool to unscrew the valve insert</li> <li>black</li> </ul>	 <p>+ 50 mm</p>
<b>519948</b> 400/20 pair	<ul style="list-style-type: none"> <li>verlängert das Ventil um <b>40 mm</b></li> <li>silber</li> </ul>	<ul style="list-style-type: none"> <li>prolongs the valve by <b>40 mm</b></li> <li>silver</li> </ul>	 <p>+ 40 mm</p>
<b>519915</b> 5.000/100	<b>VENTILADAPTER</b> von AV (Schlauch) auf Dunlop-Ventil (Pumpe), silber, mit <b>Rückschlagventil</b>	<b>VALVE ADAPTER</b> from AV (tube) to Dunlop valve (pump), silver, with <b>check valve</b>	 <p>UVP 1,50 €</p>
<b>519920</b> 3.000/100	von Dunlop/FV (Schlauch) auf AV (Pumpe), mit <b>Dichtring</b>	from Dunlop/FV (tube) to AV (pump), with <b>seal ring</b>	 <p>UVP 0,90 €</p>
<b>519916</b> 4.000/100	von FV (Schlauch) auf Dunlop-Ventil (Pumpe)	from FV (tube) to Dunlop valve (pump)	 <p>UVP 0,90 €</p>
<b>519987</b> 100 set	<b>VENTILADAPTER-SET</b> bestehend aus <ul style="list-style-type: none"> <li><b>Ventiladapter AV→DV</b> (Art. 519915) von AV (Schlauch) auf Dunlop-Ventil (Pumpe), silber, mit Rückschlagventil</li> <li><b>Ventiladapter DV/FV→AV</b> (Art. 519920) von Dunlop/FV (Schlauch) auf AV (Pumpe), mit Dichtring</li> <li><b>Ventiladapter FV→DV</b> (Art. 519916) von FV (Schlauch) auf Dunlop-Ventil (Pumpe)</li> <li>im Polybeutel mit Ventura Euroloch-header</li> </ul>	<b>VALVE ADAPTER SET</b> consisting of <ul style="list-style-type: none"> <li><b>valve adapter AV→DV</b> (art. 519915) from AV (tube) to Dunlop valve (pump), silver, with check valve</li> <li><b>valve adapter DV/FV→AV</b> (art. 519920) from Dunlop/FV (tube) to AV (pump), with seal ring</li> <li><b>valve adapter FV→DV</b> (art. 519916) from FV (tube) to Dunlop valve (pump)</li> <li>in PE bag with Ventura eurohole header</li> </ul>	 <p>UVP 3,90 €</p>
<b>519919</b> 1.000/40	<b>VENTILADAPTER</b> gebogen, <b>90°-Winkel</b> , von AV (Schlauch) auf AV (Pumpe), mit <b>Rückschlagventil</b> , für Federungselemente, kleine Laufräder, Schubkarren, ...	<b>VALVE ADAPTER</b> bent, <b>90°-angle</b> , from AV (tube) to AV (pump), with <b>check valve</b> , for shock absorber, small wheel sets, wheel barrows, ...	 <p>UVP 3,90 €</p>
<b>518819</b> 5.000/100	<b>VENTILSCHLÜSSEL AV</b> <ul style="list-style-type: none"> <li>2 in 1</li> <li>A/V <b>Ventilkappe</b> und <b>Werkzeug zum Entfernen des A/V Ventileinsatzes</b></li> <li>mit Dichtring</li> </ul>	<b>VALVE CORE TOOL AV</b> <ul style="list-style-type: none"> <li>2 in 1</li> <li>A/V <b>valve cap</b> and a <b>tool to unscrew the A/V valve core</b></li> <li>with seal ring</li> </ul>	 <p>UVP 0,90 €</p>
<b>519819</b> 500	<b>VENTILWERKZEUG / -KAPPE FV</b> <ul style="list-style-type: none"> <li>für Ventileinsatz von französischen (Sclaverand / Presta) Ventilen</li> <li><b>als Ventilkappe verwendbar</b></li> <li>Montageverpackung</li> </ul>	<b>VALVE TOOL / CAP FV</b> <ul style="list-style-type: none"> <li>for valve insert of french (Sclaverand / Presta) valves</li> <li><b>usable as valve cap</b></li> <li>OEM</li> </ul>	 <p><b>2 IN 1</b></p> <p>UVP 0,99 €</p>

## TUBELESS: GUT - GÜNSTIG - 3 in 1!

Rennfahrer verwenden oft **normale Faltreifen** und unser Tubelesskit, um jedes Gramm **Gewicht zu sparen**. Nutzen auch Sie das schlauchlose System von **M-Wave** mit Ihren **bisherigen Reifen, SCT- oder UST-Reifen**. Mit dem Tubelesskit entfällt das Wechseln und Flickern von Schläuchen und Sie **sparen Gewicht**.

- 1) Jede **herkömmliche Felge** kann **kostengünstig** auf ein **Schlauchlossystem** umgerüstet werden.
- 2) M-Wave Tubelesskit ist auch für die **Verwendung mit Kenda SCT Reifen** geeignet. So können Sie ein Tubeless-System fahren, ohne dabei das höhere Gewicht und Kosten von UST-Reifen in Kauf nehmen zu müssen.
- 3) Mit dem M-Wave Tubelesskit kann mit **nur 2 bar Luftdruck** gefahren werden, ohne dass der Reifen durch einen Felgendurchschlag (Snakebite) gefährdet ist. Dadurch erreicht man:
  - a) eine **deutlich bessere Dämpfung**
  - b) **mehr Traktion** in jedem Gelände
  - c) bergauf kann man länger im Sattel bleiben
  - d) bergab **besseres Bremsverhalten**
  - e) mehr **Grip in Kurven**
  - f) dass mit **schmaleren** und damit **leichteren Reifen** gefahren werden kann.
- 4) Durch den Einsatz dieses Systems ist der **Rollwiderstand** gegenüber einem Schlauchsystem bis zu **15 % niedriger**.
- 5) Schlauchlosreifen können nicht immer 100 % luftdicht hergestellt werden. Mit dem M-Wave Tubelesskit wird der **Reifen dicht und ist für über 6 Monate selbstflickend** (bis zu **6 mm** Löcher).

## TUBELESS: GOOD QUALITY - FAIR PRICE - 3 in 1!



Racers often use **standard folding tires** and our Tublesskit in order to **save every gram of weight**. You can also use our Tubless System from **M-Wave** with your **existing tires, SCT or UST tires**. With this Tublesskit you can avoid tube changes and repairs and at the same time **reduce weight**.

- 1) Every **conventional rim** can be converted to a **tubeless system at low costs**.
- 2) M-Wave Tublesskit is also **usable for Kenda SCT tires**. Through this you can ride a tubeless system without having to accept the higher weight and costs of UST tires.
- 3) With the M-Wave tubelesskit **only 2 bar air pressure** are required without the risk of damaging the tire by snakebite (rim cut through the tire). The effects:
  - a) **distinctly improved damping**
  - b) **improved traction** in every terrain
  - c) uphill one can stay longer in the saddle
  - d) and downhill the **braking is improved**
  - e) more **grip in turns**
  - f) due to the above advantages **smaller and lighter tires** can be used.
- 4) Through the use of this tubeless system the **rolling resistance**, in comparison with a tube system, is about **15 % lower**.
- 5) Tubeless tires cannot be manufactured 100 % airtight. M-Wave tubelesskit makes them **self-repairing**- sealing liquid closes holes or other damages up to **6 mm diameter automatically and permanently**. It keeps this function for **longer than 6 months**.

ART.-NR.	BESCHREIBUNG	DESCRIPTION	
	<b>TUBELESS HOCHDRUCK-FELGENBAND</b>	<b>TUBELESS HIGH PRESSURE RIM TAPE</b>	<b>TUBELESS</b>
	<ul style="list-style-type: none"> <li>• <b>selbstklebend</b></li> <li>• 10 Meter gerollt</li> <li>• im Polybeutel mit M-Wave Eurolochheader</li> </ul>	<ul style="list-style-type: none"> <li>• <b>adhesive</b></li> <li>• 10 meters rolled</li> <li>• in PE bag with M-Wave eurohole header</li> </ul>	
	Breite:	width:	
<b>519850</b>	19 mm	19 mm	UVP 9,90 €
<b>519822</b>	21 mm	21 mm	UVP 11,90 €
<b>519852</b>	23 mm	23 mm	UVP 11,90 €
<b>519853</b>	25 mm	25 mm	UVP 12,90 €
<b>519825</b>	27 mm	27 mm	UVP 13,90 €
<b>519842</b>	30 mm	30 mm	UVP 13,90 €
<b>519843</b>	35 mm	35 mm	UVP 13,90 €
50			
	<b>TUBELESS VENTIL</b>	<b>TUBELESS VALVE</b>	
	<ul style="list-style-type: none"> <li>• <b>Carbon</b></li> <li>• inkl. <b>2 runder und 2 eckiger Dichtungen</b></li> <li>• <b>seitlicher Luftauslass</b></li> <li>• mit <b>Ventilwerkzeug/-kappe</b> (Art. 519819)</li> <li>• 2x FV</li> <li>• mit Befestigungsmuttern</li> <li>• 1 Paar in M-Wave Eurolochbox</li> </ul>	<ul style="list-style-type: none"> <li>• <b>carbon</b></li> <li>• inkl. <b>2 round and 2 square seal rings</b></li> <li>• <b>lateral air outlet</b></li> <li>• with <b>valve tool/cap</b> (art. 519819)</li> <li>• 2x FV</li> <li>• with fixing nuts</li> <li>• 1 pair in M-Wave eurohole box</li> </ul>	<b>3 g</b>
<b>519870</b>	Höhe: 35 mm	height: 35 mm	
<b>519871</b>	Höhe: 45 mm	height: 45 mm	
50 pair			<b>2x2 SEAL RING</b>
		UVP 14,90 €	

ART.-NR. 	BESCHREIBUNG	DESCRIPTION	
<b>519463</b> 52	<b>ABDICHTFLÜSSIGKEIT &gt;TUBELESS SEALANT&lt;</b> <ul style="list-style-type: none"> <li>Abdichtflüssigkeit für <b>Tubeless-Reifen</b></li> <li>versiegelt unmittelbar Löcher von bis zu 6 mm in der Lauffläche</li> <li>Dichtmittel ist <b>CO<sub>2</sub>-Patronen-kompatibel</b></li> <li>125 ml</li> </ul>	<b>TIRE SEALANT &gt;TUBELESS SEALANT&lt;</b> <ul style="list-style-type: none"> <li>sealant for <b>tubeless tires</b></li> <li>instantly seals puncture in tread up to 6 mm</li> <li>sealant is <b>CO<sub>2</sub> cartridge compatible</b></li> <li>125 ml</li> </ul> <p style="text-align: right;">UVP 9,90 €</p>	
<b>519828</b> 18 set	<b>TUBELESSKIT &amp; PANNENSCHUTZ &gt;TU-KIT&lt;</b> <ul style="list-style-type: none"> <li>1 Set für <b>2 Reifen</b> bestehend aus:               <ul style="list-style-type: none"> <li>2 x F/V Tubeless-Ventile 47 mm</li> <li>1 x 10 m-Rolle selbstklebendes Tubeless-Felgenband, Breite 25 mm</li> <li>2 x 125 ml Abdichtflüssigkeit</li> <li>Ventilwerkzeug</li> </ul> </li> <li>in M-Wave Eurolochbox</li> </ul> <p>Gerne stellen wir für Sie Ihr individuelles Tubeless-Set zusammen. Wählen Sie dabei ein Felgenband in der passenden Breite und die passenden Ventile aus. Dazu kommt zu jedem Set das Ventilwerkzeug (Art. 519819) und zwei Flaschen Dichtflüssigkeit (Art. 519463).</p>	<b>TUBELESSKIT &amp; FLAT PREVENTION &gt;TU-KIT&lt;</b> <ul style="list-style-type: none"> <li>1 set for <b>2 wheels</b> consisting of:               <ul style="list-style-type: none"> <li>2 x F/V tubeless valves 47 mm</li> <li>1 x 10 m roll adhesive tubeless rim tape, width 25 mm</li> <li>2 x 125 ml tubeless sealant</li> <li>valve tool</li> </ul> </li> <li>in M-Wave eurohole box</li> </ul> <p style="text-align: right;">UVP 39,90 €</p> <p>We gladly arrange your individual tubeless set. Choose one rim tape in the appropriate width and the suitable valves. With every set comes a valve tool (art. 519819) and two bottles of sealant fluid (art. 519463).</p>	<div style="border: 1px solid black; padding: 2px; display: inline-block;">20" - 29" ✓</div> 
<b>519461</b> 30 set <span style="background-color: #0056b3; color: white; padding: 2px;">NICE PRICE</span>	<b>TUBELESSKIT &amp; PANNENSCHUTZ 26" - 29" &gt;ECO&lt;</b> <ul style="list-style-type: none"> <li>für fast alle handelsüblichen Hohlkammerfelgen mit FV-Felgenloch</li> <li>Felgenbreite 17 - 19 mm (innen)</li> <li>1 Set für <b>2 Reifen</b> bestehend aus:               <ul style="list-style-type: none"> <li>2 x 125 ml <b>Abdichtflüssigkeit</b> für Löcher bis <b>6 mm</b></li> <li>doppelseitiges Klebeband</li> <li>2 x Felgenband mit Ventileinbaukit</li> </ul> </li> <li>Abdichtflüssigkeit <b>umweltfreundlich</b> und <b>latexfrei</b></li> <li>in M-Wave Eurolochbox</li> </ul>	<b>TUBELESSKIT &amp; FLAT PREVENTION 26" - 29" &gt;ECO&lt;</b> <ul style="list-style-type: none"> <li>for almost all conventional double wall rims with FV rim hole</li> <li>rim width 17 - 19 mm (inner)</li> <li>1 set for <b>2 wheels</b> consisting of:               <ul style="list-style-type: none"> <li>2 x 125 ml <b>tubeless sealant</b> for holes up to <b>6 mm</b></li> <li>double sided glue strip</li> <li>2 x rim tape with valve mounting kit</li> </ul> </li> <li>Eco sealant <b>eco-friendly</b> and <b>latex-free</b></li> <li>in M-Wave eurohole box</li> </ul> <p style="text-align: right;">UVP 31,90 €</p>	<div style="border: 1px solid black; padding: 2px; display: inline-block;">26" ✓ 27.5"/650 B ✓ 29" ✓</div> <div style="border: 1px solid black; padding: 2px; display: inline-block; margin-top: 5px;">GREEN CONCEPT</div> 
<b>518817</b> 64/16	<b>REIFEN- UND SCHLAUCH-PANNENSCHUTZ-FLÜSSIGKEIT</b> <ul style="list-style-type: none"> <li>verhindert und repariert Pannen an Schläuchen und Reifen jeglicher Art</li> <li><b>dichtet Schäden bis 3 mm selbständig</b> während der Fahrt ab</li> <li>mit <b>Ventilschlüssel</b> zum Herausnehmen des Ventileinsatzes beim A/V</li> <li>spitzes Ventil zum <b>leichten Befüllen</b></li> <li>im <b>Einzelkarton</b>, 16 Stück à <b>250 ml</b> im mehrsprachigen, verkaufsfördernden <b>Thekendisplay</b></li> </ul>	<b>TIRE AND TUBE SEALANT</b> <ul style="list-style-type: none"> <li>prevents and repairs flat tires and tubes of any kind</li> <li><b>seals damages up to 3 mm automatically</b> during ride</li> <li>with <b>valve key</b> to take out the valve from A/V</li> <li>pointed valve for <b>easy filling</b></li> <li>in <b>single box</b>, 16 pcs à <b>250 ml</b> in multilingual sales promotion <b>display box</b></li> </ul> <p style="text-align: right;">UVP 6,90 €</p>	
<b>880267</b> 800	<b>REIFENFLICK-SET &gt;TUBELESS FIX&lt;</b> <ul style="list-style-type: none"> <li>in hochwertigem <b>Aluminium</b>-Gehäuse</li> <li>2 Funktionen: Reifen Reibahle und Einführwerkzeug</li> <li>verschieden dicke Streifen für kleine und große Löcher:               <ul style="list-style-type: none"> <li>5 x Ø 1,5 mm</li> <li>3 x Ø 3,5 mm</li> </ul> </li> <li><b>Gehäuse dient bei Verwendung als Hebel</b></li> <li>auf M-Wave Eurolochkarte</li> </ul>	<b>TUBELESS REPAIR KIT &gt;TUBELESS FIX&lt;</b> <ul style="list-style-type: none"> <li>in high quality <b>aluminium</b> case</li> <li>2 functions: tire reamer and insert tool</li> <li>stripes in different widths for small and big holes:               <ul style="list-style-type: none"> <li>5 x Ø 1.5 mm</li> <li>3 x Ø 3.5 mm</li> </ul> </li> <li><b>case useable as lever</b></li> <li>on M-Wave eurohole card</li> </ul> <p style="text-align: right;">UVP 15,90 €</p>	



ART.-NR.	BESCHREIBUNG	DESCRIPTION	
<b>880365</b> 300/50 <b>NEW</b>	<b>TUBELESS REPAIR KIT</b> <b>›TUBELESS FIX ECO‹</b> <ul style="list-style-type: none"> <li>mit zwei unterschiedlich dicken <b>Reibahlen</b> und <b>Einführungswerkzeug</b></li> <li>verschieden dicke Streifen für kleine und große Löcher</li> <li>5 x Ø 1,5 mm</li> <li>5 x Ø 3,5 mm</li> <li>in M-Wave Kunststoff-Box</li> </ul>	<b>TUBELESS REPAIR KIT</b> <b>›TUBELESS FIX ECO‹</b> <ul style="list-style-type: none"> <li>with two tire <b>reamers</b> of different thicknesses and <b>insert tool</b></li> <li>stripes in different widths for small and big holes</li> <li>5 x Ø 1,5 mm</li> <li>5 x Ø 3,5 mm</li> <li>in M-Wave plastic box</li> </ul>	 UVP 8,90 €
<b>519481</b> 88	<b>BEFÜLLSPRITZE FÜR DICHTMILCH</b> <ul style="list-style-type: none"> <li>ermöglicht <b>schnelles, sauberes und kontrolliertes befüllen der Dichtmilch</b></li> <li><b>keine Demontage</b> des Reifens nötig</li> <li>Dichtmilch kann (für mehr Pannenschutz) auch in einen vorhandenen Schlauch gefüllt werden</li> <li>Schraubadapter für <b>AV und FV</b></li> <li>Behältnis kann bis zu <b>60 ml</b> Dichtmilch aufnehmen</li> <li>es kann <b>jede Dichtmilch</b> verwendet werden, besonders geeignet für Art. 519463</li> <li>in M-Wave Eurolochbox</li> </ul>	<b>SEALANT SYRINGE INJECTOR</b> <ul style="list-style-type: none"> <li><b>quick, clean and controlled filling of the sealant</b></li> <li><b>no tire demounting</b> necessary</li> <li>sealant can also be applied to inner tubes (for additional puncture control)</li> <li>screw-on adapter for <b>AV and FV</b></li> <li>for up to <b>60 ml</b> sealant</li> <li>compatible for <b>all sealants</b>, especially suitable for art. 519463</li> <li>in M-Wave eurohole box</li> </ul>	<b>AV / FV</b>  UVP 16,90 €
<b>519200</b> 100 pair • <b>519340</b> 500/10	<b>HOCHDRUCK-FELGENBAND</b> <b>Top-Qualität</b> <b>20 mm x 26"</b> , 20-559 2 Stück im Polybeutel mit M-Wave Eurolochheader Montageverpackung	<b>HIGH PRESSURE RIM TAPE</b> <b>Top quality</b> <b>20 mm x 26"</b> , 20-559 2 pieces in PE bag with M-Wave eurohole header OEM	UVP 3,90 € (1 St.) UVP 1,90 €
<b>519201</b> 100 pair • <b>519309</b> 500/10	<b>20 mm x 27,5"</b> , 20-584 2 Stück im Polybeutel mit M-Wave Eurolochheader Montageverpackung	<b>20 mm x 27.5"</b> , 20-584 2 pieces in PE bag with M-Wave eurohole header OEM	UVP 3,90 € (1 St.) UVP 1,90 €
<b>519205</b> 100 pair • <b>519371</b> 500/10	<b>24 mm x 27,5"</b> , 24-584 passend für viele <b>Plus</b> -Felgen (z. B. Art. 381150 ff., 380480 ff., ...) 2 Stück im Polybeutel mit M-Wave Eurolochheader Montageverpackung	<b>24 mm x 27.5"</b> , 24-584 suitable for a lot of <b>plus</b> rims (e. g. art. 381150 et seq., 380480 et seq., ...) 2 pieces in PE bag with M-Wave eurohole header OEM	<b>PLUS</b> UVP 4,90 € (1 St.) UVP 2,40 €
<b>519203</b> 100 pair • <b>519341</b> 500/10	<b>16 mm x 28" / 29" / 700C</b> , 16-622 2 Stück im Polybeutel mit M-Wave Eurolochheader Montageverpackung	<b>16 mm x 28" / 29" / 700C</b> , 16-622 2 pieces in PE bag with M-Wave eurohole header OEM	UVP 3,90 € (1 St.) UVP 1,90 €
<b>519204</b> 100 pair • <b>519342</b> 500/10	<b>20 mm x 28" / 29"</b> , 20-622 2 Stück im Polybeutel mit M-Wave Eurolochheader Montageverpackung	<b>20 mm x 28" / 29"</b> , 20-622 2 pieces in PE bag with M-Wave eurohole header OEM	UVP 3,90 € (1 St.) UVP 1,90 €
• <b>519206</b> 500/10	<b>24 mm x 28" / 29"</b> , 24-622 Montageverpackung	<b>24 mm x 28" / 29"</b> , 24-622 OEM	<b>PLUS</b> (1 St.) UVP 2,40 €

ART.-NR. 	BESCHREIBUNG	DESCRIPTION	
<p><b>519400</b></p> <p><b>519401</b> 250/10 pair</p>	<p><b>SELBSTKLEBENDES HOCHDRUCK-GEWEBE-FELGENBAND</b></p> <ul style="list-style-type: none"> <li>aus sehr hochwertigem, 0,5 mm starkem, blauem Nylongewebe</li> <li>eine spezielle Klebeschicht verhindert Verrutschen auch bei starker Belastung und hohen Temperaturen</li> <li>sehr leicht (nur 15 g bei 16-622)</li> <li>passend für 12" - 29"</li> <li>mit Ventilloch</li> <li>1 Paar = 2 x 2 m im Polybeutel mit M-Wave Eurolochheader</li> </ul>	<p><b>SELF-ADHESIVE HIGH PRESSURE TEXTILE RIM TAPE</b></p> <ul style="list-style-type: none"> <li>high-grade, 0.5 mm thick, blue nylon fabric</li> <li>the special glue layer prevents the tape from slipping, even at intense strain or high temperatures</li> <li>very light (only 15 g in size 16-622)</li> <li>suitable for 12" - 29"</li> <li>with valve hole</li> <li>1 pair = 2 x 2 m in PE-bag with M-Wave eurohole header</li> </ul>	     <p>UVP 4,90 €</p>
<p><b>519516</b> 500</p>	<p><b>FELGENBAND</b></p> <ul style="list-style-type: none"> <li>Gummi</li> <li>18 mm breit</li> <li>26" - 29"</li> <li>Montageverpackung</li> </ul>	<p><b>RIM TAPE</b></p> <ul style="list-style-type: none"> <li>rubber</li> <li>18 mm wide</li> <li>26" - 29"</li> <li>OEM</li> </ul>	 <p>UVP 0,90 €</p>
<ul style="list-style-type: none"> <li><b>519560</b> 500/50</li> <li><b>519561</b> 500/50</li> <li><b>519562</b> 500/25</li> <li><b>519563</b> 500/50</li> <li><b>519564</b> 500/50</li> <li><b>519565</b> 500/25</li> </ul>	<p><b>FELGENBAND</b></p> <ul style="list-style-type: none"> <li>18 mm breit</li> <li>Montageverpackung</li> </ul>	<p><b>RIM TAPE</b></p> <ul style="list-style-type: none"> <li>18 mm wide</li> <li>OEM</li> </ul>	 <p>UVP 0,60 €</p>
<p><b>519377</b> 250/25</p>	<p><b>FELGENBAND</b></p> <ul style="list-style-type: none"> <li>für Fat Tire Bikes</li> <li>65 mm breit</li> <li>26"</li> <li>rot</li> <li>Montageverpackung</li> </ul>	<p><b>RIM TAPE</b></p> <ul style="list-style-type: none"> <li>for Fat Tire Bikes</li> <li>65 mm wide</li> <li>26"</li> <li>red</li> <li>OEM</li> </ul>	 <p>UVP 3,90 €</p>
<p><b>519990</b> 2.000/100</p> <p><b>519991</b> 2.000/100</p> <p><b>519902</b> 5.000/100</p> <p><b>519985</b> 1.000 set</p>	<p><b>VENTILEINSATZ</b></p> <ul style="list-style-type: none"> <li>für AV</li> <li>100 Stück im Polybeutel</li> </ul> <p><b>für FV</b></p> <ul style="list-style-type: none"> <li>100 Stück im Polybeutel</li> </ul> <p><b>für Dunlop Express Ventil, mit Staubschutzkappe</b></p> <ul style="list-style-type: none"> <li>100 Stück im Polybeutel</li> </ul> <p>2 Stück auf Kenda Eurolochkarte</p>	<p><b>VALVE INSERT</b></p> <ul style="list-style-type: none"> <li>for A</li> <li>100 pieces in PE-bag</li> </ul> <p><b>for FV</b></p> <ul style="list-style-type: none"> <li>100 pieces in PE-bag</li> </ul> <p><b>for Dunlop Express valve, with dust cap</b></p> <ul style="list-style-type: none"> <li>100 pieces in PE-bag</li> </ul> <p>2 pieces on Kenda eurohole card</p>	     <p>UVP 0,59 €</p> <p>UVP 0,89 €</p> <p>UVP 0,90 €</p> <p>UVP 1,90 €</p>

ART.-NR.	BESCHREIBUNG	DESCRIPTION	
<b>519988</b> • für AV • 100 Stück im Polybeutel  <b>519989</b> 2.000/100 • für FV • 100 Stück im Polybeutel	<b>FELGENMUTTER</b>  <b>RIM NUT</b> • for AV • 100 pieces in PE-bag  • for FV • 100 pieces in PE-bag	UVP 0,19 €  UVP 0,19 €	
<b>519980</b> 5.000/100 • Überwurfmutter für DV • 100 Stück im Polybeutel	<b>ÜBERWURFMUTTER FÜR DV</b> • screw cap for DV • 100 pieces in PE-bag	UVP 0,20 €	
<b>519960</b> 2.000/100 • für FV • aus transparentem Kunststoff • 100 Stück im Polybeutel	<b>VENTILKAPPE</b> • für FV • made of transparent plastic • 100 pieces in PE-bag	UVP 0,20 €	
<b>519909</b> 100 set • eloxiertes Aluminium • für AV (und FV) geeignet durch Doppelgewinde • 30 Stück, farbig sortiert • in M-Wave Thekendisplay	<b>VENTILKAPPEN-SET</b> • anodised aluminium • suitable for AV (and FV) due to double threading • 30 pieces, assorted colours • in M-Wave sales display	UVP 44,90 €/ set	
<b>519890</b> 5.000/100 schwarz  <b>519893</b> 5.000/100 rot  <b>519894</b> 5.000/100 blau  <b>519895</b> 2.500/100 grün  <b>519897</b> 2.500/100 orange  <b>519899</b> 2.500/100 lila	<b>VENTILKAPPEN</b> • eloxiertes Aluminium • für AV geeignet • mit Dichtungsring • 100 Stück im Polybeutel  schwarz  rot  blau  grün  orange  lila	<b>VALVE CAP</b> • anodised aluminium • suitable for AV • with seal ring • 100 pieces in PE-bag  black  red  blue  green  orange  purple  UVP 0,39 €	
<b>519970</b> 60 set • Aluminium bzw. Kunststoff • für AV/Schraderventil • 15 verschiedene Motive: Patronenhülse, Hutmutter, Totenkopf, Fußball, Basketball, Schwarze 8, Happy Ball, Würfel • sortiert in Ventura Thekendisplay (15 x 2 Stück = 30 Stück = 1 Set)	<b>VENTILKAPPEN-SET</b> • Aluminium bzw. Kunststoff • für AV/Schraderventil • 15 verschiedene Motive: Patronenhülse, Hutmutter, Totenkopf, Fußball, Basketball, Schwarze 8, Happy Ball, Würfel • sortiert in Ventura Thekendisplay (15 x 2 Stück = 30 Stück = 1 Set)	UVP 34,90 €/ set	



# KENDA



## Alluvium

black / black - brown

(Art. 521760/6 - 700 x 40C)

(Art. 521761/5 - 700 x 45C)

## ALLUVIUM – FÜR SPASS AM GRAVELN, IMMER UND ÜBERALL!

Kenda Gravelreifen sind der ultimative Begleiter für alle, die gerne abseits der ausgetretenen Pfade unterwegs sind. Bestes Beispiel ist der neue Alluvium, der leichtes Rollen auf befestigten Straßen und sicheren Grip auf Schotter und Waldwegen bietet. Fahrspaß ist damit in allen Situationen garantiert.

## ALLUVIUM – FOR GRAVEL FUN, ALWAYS AND EVERYWHERE!

Kenda gravel tires are the ultimate companion for anyone who likes to venture off the beaten track. The best example is the new Alluvium, which offers easy rolling on paved roads and secure grip on gravel and forest paths. Riding fun is guaranteed in all situations.



# DRIVEN TO BUILD BETTER TIRES

Kenda spielt mittlerweile im Konzert der ganz Großen mit. In zahlreichen Weltcup verschiedenster Bike-Disziplinen fahren Top-Athleten, wie z.B. das Ausnahmetalent und 5-facher Worldcupgesamtsieger Aaron Gwin. Ohne bestes Reifenmaterial wäre das nicht möglich gewesen.

Kenda now plays in the concert of the greats. In numerous World Cups of different bike disciplines there are top athletes, such as the exceptional talent and 5-time World Cup winner Aaron Gwin. Without the best tire material that would not have been possible.



**Pinner Pro ATC**  
(Art. 521996/98)

**Pinner Pro AGC**  
(Art. 521997/99)

## PINNER – PIN ES WIE GWIN!

Der Pinner wurde exklusiv in Zusammenarbeit mit Aaron Gwin entwickelt und liebt es, auf trockenen und staubigen Strecken losgelassen zu werden. Zeigen Sie es allen, gehen Sie es schnell an, dann wissen Sie genau, wo die Grenzen liegen.

## PINNER – PIN IT LIKE GWIN!

Exclusively developed in cooperation with Aaron Gwin, the Pinner loves to be let loose on dry and dusty tracks. Point it down, let it go fast, and know exactly where the limits are.

RENNRAD / CX / TREKKING

ROAD / CX / TREKKING

**GRAVEL CASING TECHNOLOGY** **GCT**



Pannenschutz Seitenwand  
Sidewall Cut Protection ●●●○○

Pannenschutz Lauffläche  
Tread Puncture Protection ●●●○○

**Gravity**

SCT Material wird von Wulstkern zu Wulstkern gelegt, um vor Schnitten und Pannen zu schützen und erleichtert den Umbau auf Tubeless.

SCT material wraps around the tire from bead to bead, protecting it from cuts and punctures, and allowing easy tubeless conversion.

**K-ARMOR** **KA**



Pannenschutz Seitenwand  
Sidewall Cut Protection ●○○○○

Pannenschutz Lauffläche  
Tread Puncture Protection ●●●●○

**Road**

Urheberrechtlich geschütztes, von Kenda entwickeltes und sehr leichtes Pannenschutz-Material. Erhöht die Durchstoßfestigkeit um 174 % zu üblichen Aramid-Einlagen.

Proprietary lightweight puncture breaker material developed by Kenda. Increases the puncture resistance by 174 % over traditional Aramid breakers.

**IRON CAP BELT** **ICP**



Pannenschutz Seitenwand  
Sidewall Cut Protection ●○○○○

Pannenschutz Lauffläche  
Tread Puncture Protection ●●●○○

**Road**

Eine Lage gewebtes Material, das direkt unter der Lauffläche liegt. So wird zusätzlicher Pannenschutz bei minimalem Mehrgewicht erreicht.

A layer of woven material that runs directly under the tread area. Therefore offering additional puncture protection at a minimum weight.

**TUBELESS READY CASING** **TLR**



Pannenschutz Seitenwand  
Sidewall Cut Protection ●●●○○

Pannenschutz Lauffläche  
Tread Puncture Protection ●●●○○

**Road**

Das SCT Material liegt um den kompletten Reifen für extra Pannenschutz. Zusätzlich wird der Wulstkern für mehr Luftdichtigkeit modifiziert.

The SCT material is layed all around the tire for extra puncture protection. Additionally, the bead is modified to create a tight air seal.

**K-SHIELD +** **KS+**



Pannenschutz Seitenwand  
Sidewall Cut Protection ●●○○○

Pannenschutz Lauffläche  
Tread Puncture Protection ●●●●○

**Trekking, City, Commuting**

Eine 5 mm Coextrusion eines Gummi-Elastomers. Höchstes Pannenschutz-niveau für vielseitigen Einsatz und hohe Fahrqualität.

A 5 mm sub-tread coextrusion of a rubber elastomer. Highest puncture protection level for versatile use and a great ride quality.

**K-SHIELD** **KS**



Pannenschutz Seitenwand  
Sidewall Cut Protection ●○○○○

Pannenschutz Lauffläche  
Tread Puncture Protection ●●●○○

**Trekking, City, Commuting**

Eine Schicht einer leichten flexiblen Gummi-Aramid-Mischung mit keramischen Einschlüssen. Entwickelt, um Einsätze zu vermeiden und die Lebensdauer des Reifens zu erhöhen.

A layer of light, flexible rubber containing aramid and ceramic particles for increased puncture resistance. Designed to prevent punctures and increase tire life.

MTB

MTB

**TUBELESS RACE** **TR**



Pannenschutz Seitenwand  
Sidewall Cut Protection ●○○○○

Pannenschutz Lauffläche  
Tread Puncture Protection ●○○○○

**MTB**

Die leichteste XC Karkasse, die Kenda anbietet. Schnell rollend und tubeless ready.

The lightest XC casing option Kenda offers. Fast rolling and tubeless ready.

**ADVANCED GRAVITY CASING** **AGC**



Pannenschutz Seitenwand  
Sidewall Cut Protection ●●●●○

Pannenschutz Lauffläche  
Tread Puncture Protection ●●●●○

**DH, Freeride, Enduro Race**

Entwickelt für raue DH-Bedingungen auf Weltcup-Niveau. Kugelsichere Karkasse mit höchstmöglichem Schutz. Super griffige Mischung. Tubeless Ready.

Developed for rough DH conditions on World Cup level. Bullet proof casing with the highest possible protection. Super tacky compound. Tubeless Ready.

**ADVANCED TRAIL CASING** **AEC**



Pannenschutz Seitenwand  
Sidewall Cut Protection ●●●●○

Pannenschutz Lauffläche  
Tread Puncture Protection ●●●●○

**Freeride, Enduro, Enduro Race**

Robustes Gehäuse mit höchstmöglichem Schutz. Der AEC füllt die Lücke zwischen der Stärke von AGC und dem gewichtsoptimierten ATC.

Robust casing with the highest possible protection level. AEC fills the gap between the burliness of AGC and the weight optimized ATC.

**ADVANCED TRAIL CASING** **ATC**



Pannenschutz Seitenwand  
Sidewall Cut Protection ●●●○○

Pannenschutz Lauffläche  
Tread Puncture Protection ●●●○○

**All Mountain, Trail**

Entwickelt für jede Art von Trails. Kombiniert ein hohes Schutzniveau (Seitenwand und Lauffläche) mit einer griffigen Mischung für den besten Fahrkomfort. Tubeless Ready.

Developed for every kind of trail riding. Combines great protection level (sidewall and sub-tread) with grippy compound for the best ride comfort. Tubeless Ready.

**SIDEWALL CASING TECHNOLOGY** **SCT**



Pannenschutz Seitenwand  
Sidewall Cut Protection ●●●○○

Pannenschutz Lauffläche  
Tread Puncture Protection ●○○○○

**Marathon, XC, Trail**

Vielseitige Karkasse mit großer Allround-Leistung, die sowohl einen hohen Seitenschutz als auch gute Rolleigenschaften und geringes Gewicht bietet.

Versatile casing with great all-round performance offering both high protection on sidewalls, a fast rolling compound and low weight.

**ELECTRIC MOUNTAIN CASING** **EMC**



Pannenschutz Seitenwand  
Sidewall Cut Protection ●●●●○

Pannenschutz Lauffläche  
Tread Puncture Protection ●●●●○

**(Fast) E-Mountain Bikes, Trails and rough terrains**

Robuste Karkasse und Offroad-Mischung, speziell für Elektro-Mountainbikes entwickelt. ECE-R75 zertifiziert. Tubeless Ready.

Robust casing and offroad compound specifically developed for electric mountainbikes. ECE-R75 certified. Tubeless Ready.

## GUMMIMISCHUNGEN

## RUBBER COMPOUNDS



**R3C** (= DTC für Road und MTB) Gummimischung mit sehr niedrigem Rollwiderstand, greift auch in Kurven (besonders geeignet bei Nässe) und kann sowohl für Rennräder als auch für Mountainbikes genutzt werden. Schnell und leicht - dies ist keine Alltagsmischung.

**R3C** (= DTC for road and MTB) Super low rolling resistance rubber, that also grips in corners (especially suitable in wet conditions) and can be used on racing bikes as well as mountain bikes. Fast and light - this isn't your daily commuter compound.



**R2C** (= DTC für Rennräder) Zwei-Komponenten-Mischung für die Straße mit härterem Mittelbereich und weicheren Flanken. R2C-Reifen eignen sich für die ganzjährige Verwendung, auch bei nassen Straßen.

**R2C** (= DTC for racing bikes) Road double compound with harder center area and softer rubber at the sides. R2C tires are usable for all season usage, also on wet streets.



**L3R** und **L3R Pro** High-Tech Gummimischung, um "den besten Kompromiss zwischen Leichtgewicht, Langlebigkeit und Rollwiderstand" zu erreichen.

**L3R** and **L3R Pro** high performance rubber compounds for extending longevity, lightweight and rolling resistance.



**EN-DTC** (= Enduro Dual Tread Compound) kombiniert die Mischung aus 55/62/55 ShA für hohen Grip auf der Lauffläche und einen besseren Rollwiderstand als andere DTC Mischungen.

**EN-DTC** (= Enduro Dual Tread Compound) combines rubber compounds 55/62/55 ShA for high traction of the tread and less rolling resistance than other DTC compounds.



**Stick-E COMPOUND** Weiche "50 ShA Gummimischung" mit sehr langsamem "Rebound-Effekt". Dadurch klebt der Reifen fast am Untergrund, was eine super Traktion beim Beschleunigen, in Kurven und beim Bremsen bewirkt.

**Stick-E COMPOUND** A slow rebound rubber (50 ShA durometer) for grip and traction control. The slow rebound rubber conforms to the trail, rock or roots surface instead of bouncing off it.



**RSR** (= Race Stick-E Rubber) Grip in Rennsituationen in einer neuen Dimension und extrem weich und griffig für eine Vielzahl von Oberflächen und Bedingungen. Das weiche Material bietet nicht nur überlegenen Grip, sondern auch zusätzlichen Federungskomfort, da sich jeder Stollen verbiegt und der Trailoberfläche anpasst.

**RSR** (= Race Stick-E Rubber) is a compound that takes grip to a whole new level. The RSR is super soft and sticky for a variety of surface types and conditions. The soft compound provides not only superior grip, but also works as a small degree of independent suspension as each tire knob flexes and reform on the trail surface.

## ZUSÄTZLICHE EIGENSCHAFTEN

## ADDITIONAL FEATURES



**RHP** (= Reflective Hot Patch) an der Seite des Reifens für bessere Sichtbarkeit in der Dämmerung, Abendstunden oder bei schlechten Wetterverhältnissen stellt sicher, dass Radfahrer besser im Straßenverkehr gesehen werden. Das Reflective Hot Patch ist ein wichtiger Zusatz für die Sicherheit des Fahrers.

**RHP** (= Reflective Hot Patch) on the tire's side for better visibility in dawn, dusk, evening hours or bad weather conditions, making sure that cyclists are more visible in traffic. The Reflective Hot Patch is an important addition for the rider's safety.



**E-BIKE GEEIGNET** Durch eine Verstärkungseinlage erfüllen die Reifen auch die erhöhten Anforderungen von E-Bikes.

**E-BIKE APPROVED** A reinforcement layer makes the tires meet the higher requirements for E-bikes.



**E-50** weist darauf hin, dass der Reifen ECE-R75 zertifiziert ist und auch für E-Bikes mit 50 km/h Maximalgeschwindigkeit genehmigt ist.

**E-50** Indicates that the tire is ECE-R75 certified and therefore approved for use on e-bikes with maximum speed of 50 km/h.



## UNIVERSALSCHLÄUCHE

- hochelastische Spezial-Butyl-Mischung
- doppelte Kontrolle auf Luftundurchlässigkeit
- Einzelkarton = 50 Stück im Exportkarton
- Montageverp. = 100 Stück im Exportkarton, 25 Stück im Polybeutel



← 1,00 mm = Standard

"Bester Rollwiderstand in der Standard-Kategorie, zudem mit gutem Durchschlagschutz."



## UNIVERSAL TUBES

- highly elastic special Butyl mixture
- double check of air-tightness
- box = 50 pcs. in export carton
- OEM = 100 pcs. in export carton, 25 pcs. in PE bag



← 1.00 mm = standard

"Best rolling resistance in the standard category, moreover with good snake-bite resistance."



	GRÖSSE SIZE	ETRTO NR. ETRTO NO.	VENTIL VALVE	ART.-NR. ART.-NO.	BESONDERHEIT SPECIALTY	
8"	8 1/2x2.0 (E-Scooter ✓)		AV 45° 70° UVP 5,90 €	511808	AV 45°/70° abgewinkelt / bent	
10"	10x2.0	54-152	AV 45° 70° UVP 5,90 €	515002	AV 45°/70° abgewinkelt / bent	
12"	12 1/2x1.75 - 2 1/4	47/62 - 203	DV 26.5 mm	512501	Montageverp. / OEM, molded	
			DV 26.5 mm	514561		<b>NEW</b>
			AV 35 mm	512301		
			AV 35 mm	513370		Montageverp. / OEM, non-molded
			AV 45° 70°	512803		AV 45°/70° abgewinkelt / bent
			AV 45° 70° UVP 5,90 €	513300	<b>NEW</b> AV 45°/70° abgewinkelt / bent Montageverp. / OEM, non-molded	
14"	14x1 3/8 - 1.75	32/37/47 - 288/298/254	DV 26.5 mm	516587	<b>NEW</b>	
	14x1.75 - 2.125	47/57 - 254/263	AV 35 mm	512304		
			AV 35 mm UVP 5,90 €	514320	<b>NEW</b> Montageverp. / OEM, molded	
16"	16x1.75 - 2.125	47/57 - 305	DV 26.5 mm	512503	Montageverp. / OEM, non-molded	
			AV 35 mm	512303		
			AV 35 mm UVP 5,90 €	513371		
18"	18x1.75 - 2.125	47/57 - 355	AV 35 mm	512305	Montageverp. / OEM, non-molded	
			AV 35 mm UVP 5,90 €	513372		
20"	20x1.25 - 1.50	32/40 - 406	AV 35 mm UVP 5,90 €	512320		
	20x1.75 - 2.125	47/57 - 406	DV 26.5 mm	512507	Montageverp. / OEM, non-molded	
			DV 26.5 mm	513573		
			AV 35 mm	511307		
			AV 35 mm	514307		
				FV 48 mm UVP 5,90 €	512200	
20x2.125 - 2.35	55/58 - 406	AV 35 mm UVP 5,90 €	512324			
20x2.4 - 2.8	61/71 - 406	FV 48 mm UVP 8,90 €	512220	<b>PLUS ✓</b>		
24"	24x1.3/8 (Wheelchair ✓)	32/40 - 540/541	AV 35 mm UVP 5,90 €	516316		
	24x1.75 - 2.125	47/57 - 507	DV 26.5 mm	513574	Montageverp. / OEM, non-molded	
			DV 35 mm	512510		
			AV 35 mm	512310		
			AV 35 mm UVP 5,90 €	513374		
24x2.3 - 2.6	56/62 - 507	AV 35 mm UVP 8,90 €	516357			





DUNLOP-EXPRESS  
28/35/40 mm



SCLAVERAND/FRENCH/PRESTA  
32/48/60/80 mm



AUTO/SCHRADER/AMERICAN  
35/40/48 mm



AUTO/SCHRADER/AMERICAN

	GRÖSSE SIZE	ETRTO NR. ETRTO NO.	VENTIL VALVE	ART.-NR. ART.-NO.	BESONDERHEIT SPECIALTY
26"	26x1.0-1.5	26/40-559	FV 48mm UVP 6,90 €	512211	
	26x1 3/8-1.75	32/47-559/590	DV 26.5mm UVP 5,90 €	511512	
	26x1.75-2.125	47/57-559	DV 35mm	512513	
			DV 35mm	513576	Montageverp. / OEM, non-molded
			AV 35mm	512313	
			AV 35mm	514313	Montageverp. / OEM, non-molded
			AV 48mm	512314	
			AV 48mm	513376	Montageverp. / OEM, non-molded
			FV 32mm	512213	
	FV 48mm UVP 5,90 €	512226			
26x2.1-2.35	54/58-559	AV 35mm UVP 5,90 €	512306		
26x3.0	68-559	AV 35mm UVP 9,90 €	516804		
26x3.5-4.0	86/98-559	AV 35mm UVP 14,90 €	512344	for Fat Tire/Snow Bikes	
26x4.5-4.8	116/122-559	AV 35mm UVP 16,90 €	514402 <sub>20</sub>		
27.5"	27.5/650 B x 1.25 - 1.5	32/40-584	FV 48mm UVP 7,90 €	516275	
	27.5/650 B x 1.75 - 2.125	45/54-584	FV 48mm UVP 7,90 €	512276	
	27.5/650 B x 2.0 - 2.35	52/58-584	AV 40mm	512327	
			FV 32mm	513277	Montageverp. / OEM, non-molded
			FV 48mm UVP 7,90 €	512265	
	27.5/650 B x 2.4 - 2.8	60/71-584	FV 48mm UVP 8,90 €	511277	PLUS ✓
27.5/650 B x 2.8 - 3.2	71/81-584	FV 48mm UVP 14,90 €	511283		
28"	700 x 23 - 26 C	23/26-622	FV 32mm	512215	
			FV 48mm	516292	
			FV 60mm UVP 5,90 €	512491	Ventileinsatz herausschraubbar / removable valve insert
			FV 80mm UVP 8,90 €	512280	Ventileinsatz herausschraubbar / removable valve insert

# UNIVERSAL- / PANNENSCHUTZSCHLÄUCHE UNIVERSAL / PUNCTURE PROTECTION TUBES

**KENDA**

	GRÖSSE SIZE	ETRTO NR. ETRTO NO.	VENTIL VALVE	ART.-NR. ART.-NO.	BESONDERHEIT SPECIALTY			
28"	700 x 28 - 45 C = 27/28 x 1 1/8 + 1 1/4 + 1 3/8 + 1 1/2 + 1.75	28/47 - 622/635	DV 35 mm	512517	Montageverp. / OEM, non-molded			
			DV 35 mm	513578				
			DV 40 mm	512557				
						AV 35 mm	512317	Montageverp. / OEM, non-molded
					AV 35 mm	513378		
					FV 32 mm	512217		
					FV 48 mm	512219		
		FV 60 mm	UVP 5,90 €	512286				
29" 28"	29/28 x 1.9 - 2.35	50/58 - 622	AV 35 mm	512329	Montageverp. / OEM, non-molded			
			AV 48 mm	516389				
			FV 32 mm	512229				
			FV 32 mm	513279				
			FV 48 mm	UVP 7,90 €		512299		
	29 x 2.4 - 2.8	60/71 - 622	FV 48 mm	UVP 9,90 €	516003	<b>PLUS ✓</b>		

## AIROLUTION

## AIROLUTION





**KENDA**  
**AIROLUTION**

PUMP LESS. RIDE LONGER.

Hält die Luft viermal länger  
+25 % höherer Pannenschutz  
Zum Patent angemeldete Technologie

Holds air 4 times longer  
+25 % higher puncture protection  
Patent pending technology

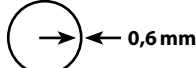
12"	12 x 1.75 - 2.25		AV 35 mm	UVP 12,90 €	518164	96 g
16"	16 x 1.50 - 2.25		AV 35 mm	UVP 12,90 €	518165	128 g
20"	20 x 2.00 - 2.40		AV 35 mm	UVP 12,90 €	518154	187 g
24"	24 x 2.00 - 2.40		AV 35 mm	UVP 12,90 €	518155	231 g
26"	26 x 2.00 - 2.40		AV 48 mm	UVP 12,90 €	518156	256 g
			FV 48 mm	UVP 12,90 €	518157	252 g
27.5"	27.5/650 B x 2.00 - 2.40		FV 48 mm	UVP 12,90 €	518158	285 g
	27.5/650 B x 2.40 - 2.80		FV 48 mm	UVP 19,90 €	518160	358 g
28" 29"	700 x 28 - 35 C		AV 48 mm	UVP 12,90 €	518150	165 g
			FV 48 mm	UVP 12,90 €	518151	161 g
	700 x 30 - 43 C		AV 48 mm	UVP 12,90 €	518152	180 g
			FV 48 mm	UVP 12,90 €	518153	176 g
	29 x 2.00 - 2.40		FV 48 mm	UVP 12,90 €	518162	274 g
	29 x 2.40 - 2.80		FV 48 mm	UVP 19,90 €	518163	381 g

ART.-NR. ART.-NO.	GRÖSSE SIZE	ETRTO NR. ETRTO NO.	VENTIL VALVE				ULTRALITE
515219	26 x 1.9 - 2.125	47/57-559	UVP 9,90 €	AV	35 mm	120 g	  
515258			UVP 9,90 €	FV	48 mm	120 g	
515245	27.5/650 B x 2.1 - 2.4	52/60-584	UVP 9,90 €	FV	48 mm, removable	148 g	
515215	700 x 18 - 23 C	18/23-622	UVP 9,90 €	FV	48 mm	71 g	
515280	700 x 23 - 26 C	23/26-622	UVP 9,90 €	FV	80 mm	75 g	
515290 50/10	29/28 x 1.9 - 2.35	50/58-622	UVP 9,90 €	FV	48 mm	155 g	

## PANNENSCHUTZ

## SELF-SEAL

## PUNCTURE PROTECTION

mit **Pannenschutzfüllung**, dichtet Löcher bis 3 mm Durchmesser **selbständig** ab, **keine umständliche Reparatur** notwendig

with **puncture protection filling**, seals holes up to 3 mm diameter by **itself**, **no laborious repair** necessary

518919	26 x 1.75 - 2.125	47/57-559	UVP 9,90 €	AV	40 mm
518915			UVP 9,90 €	FV	48 mm
518942	27.5/650 B x 2.0 - 2.35	52/58-584	UVP 9,90 €	FV	48 mm
518923	700 x 18 - 25 C	18/25-622/630	UVP 9,90 €	FV	48 mm
518924	700 x 28 - 45 C	28/47-622/635	UVP 9,90 €	AV	40 mm
518939 50	29/28 x 1.9 - 2.35	50/58-622	UVP 9,90 €	AV	40 mm

"Der Kenda-Schlauch dichtet Löcher bis zu 3 mm ab. Die Nagelprobe (4 Nägel!) hat er souverän weggesteckt, nicht mal nachpumpen war nötig."

"The Kenda tube seals holes up to 3 mm. The acid test (4 nails!) was passed easily. No pumping was necessary."



## ZWEI-END-SCHLAUCH

## TWO-END TUBE

- schnelle und einfache Montage ohne Ausbau des Laufrads möglich
- hervorragend geeignet für **E-Bikes** und Räder mit **Rücktritts-** und **Schaltungs-naben**
- besonders **belastbar und pannen-resistent** durch 1,10 mm Wandstärke
- im Einzelkarton
- VE: 100/20

- **fast and easy mounting** possible **without detaching the wheel**
- excellently suitable for **e-bikes** and bikes with **coaster** and **gear hub**
- especially **durable and breakdown resistant** through 1.10 mm wall thickness
- in box
- unit: 100/20

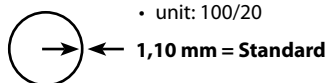

518200	20 x 1.90 - 2.10	50/54-406	UVP 12,90 €	AV	40 mm
518260	26 x 1.60 - 1.75	40/47-559	UVP 12,90 €	AV	40 mm
518263	26 x 1.90 - 2.10	50/54-559	UVP 12,90 €	AV	40 mm
518280	700 x 32/35 C	32/37-622/635	UVP 12,90 €	AV	40 mm
518281			UVP 12,90 €	FV	47 mm
518283	700 x 38/45 C	40/47-622/635	UVP 12,90 €	AV	40 mm
518284			UVP 12,90 €	FV	47 mm
518291	28/29 x 1.90 - 2.10	50/54-622	UVP 12,90 €	FV	47 mm



Art. 529996



Art. 529995

	GRÖSSE SIZE	ETRTO NR. ETRTO NO.	ART.-NR. ART. NO.	PROFIL TREAD	TYP TYPE	SEITE PAGE
<b>29"</b>	<b>29 x 2.10</b>	<b>54-622</b>	<b>520540</b>	Kadre (K-1027)	MTB	497
			<b>523747</b>	Small Block Eight Pro (K-1047)	MTB	500
			<b>523395</b>	Small Block Eight Elite (K-1047)	MTB	500
			<b>523329</b>	Small Block Eight Sport (K-1047)	MTB	500
			<b>529076</b>	50 Fifty (K-1104A)	MTB	501
			<b>528115</b>	Klondike Sport (K-1013)	MTB	503
	<b>29 x 2.20</b>	<b>56-622</b>	<b>521956</b>	Regolith Pro (K-1214)	MTB	493
			<b>521949</b>			
			<b>520992</b>	Karma 2 Pro (K-1237)	MTB	494
			<b>520993</b>			
			<b>521300</b>	Booster Pro (K-1227)	MTB	495
			<b>521301</b>			
			<b>529289</b>	Kadre Sport Protect (K-1027)	MTB	497
			<b>529299</b>	Amrak (K-1247)	MTB	498
			<b>520997</b>	Rush Pro (K-1245)	MTB	499
	<b>520999</b>					
	<b>29 x 2.35</b>	<b>55-622</b>	<b>529069</b>	Aptor (K-1153)	MTB	504
	<b>29 x 2.40</b>	<b>60-622</b>	<b>521972</b>	Helldiver Pro (K-1202)	MTB	489
			<b>521962</b>	Hellkat Pro (K-1201)	MTB	490
			<b>521973</b>			
		<b>61-622</b>	<b>528236</b>	Nevegal <sup>2</sup> Pro (K-1211E)	MTB	495
<b>521986</b>			Gran Mudda Pro (K-1235)	MTB	492	
<b>521996</b>			Pinner Pro (K-1241A)	MTB	492	
<b>521997</b>						
<b>521974</b>			Regolith Pro (K-1214)	MTB	493	
<b>520994</b>			Karma 2 Pro (K-1237)	MTB	494	
<b>520995</b>						
<b>529291</b>			Kadre (K-1027)	MTB	497	
<b>520996</b>			Rush Pro (K-1245)	MTB	499	
<b>520998</b>						
<b>29 x 2.60</b>	<b>66-622</b>	<b>528235</b>	Hellkat Pro (K-1201E)	MTB	490	
		<b>521963</b>	Hellkat Pro (K-1201)	MTB	490	
		<b>529691</b>	Amrak (K-1247)	MTB	498	
<b>28"</b>	<b>700 x 23 C</b>	<b>23-622</b>	<b>521780</b>	Kountach Pro (K-1092)	Road	483
			<b>522815</b>	Kontender (K-196)	Road	484
			<b>529660</b>			
			<b>529661</b>			
			<b>529662</b>			
			<b>529663</b>			
			<b>529664</b>			
			<b>529665</b>			
	<b>529075</b>					
	<b>700 x 25 C</b>	<b>25-622</b>	<b>521752</b>	Valkyrie Pro TLR (K-1160X)	Road	482
			<b>521758</b>	Valkyrie Pro (K-1160X)	Road	482
<b>521755</b>			Valkyrie Elite (K-1160X)	Road	483	
<b>521781</b>			Kountach Pro (K-1092)	Road	483	



	GRÖSSE SIZE	ETRTO NR. ETRTO NO.	ART.-NR. ART. NO.	PROFIL TREAD	TYP TYPE	SEITE PAGE
28"	700 x 26 C	26-622	522817	Kontender (K-196)	Road	484
			521771	Kontender Sport Protect (K-196)	Road	484
			520589	Kontender (K-196)	Road	485
			520772			
			520773			
			520774			
			520775			
			520776			
			520777			
			520778			
700 x 28 C	28-622	521753	Valkyrie Pro TLR (K-1160X)	Road	482	
		521759	Valkyrie Pro (K-1160X)	Road	482	
		521756	Valkyrie Elite (K-1160X)	Road	483	
		521718	Valkyrie Sport (K-1160X)	Road	483	
		521820	Kwick Roller Sport (K-1029)	Road	485	
700 x 30 C	30-622	521714	Valkyrie Pro (K-1160X)	Road	482	
		529180	Kwick (K-879)	Gravel / CX	488	
700 x 32 C	32-622	521735	Small Block Eight (K-1047)	Gravel / CX	487	
700 x 35 C	35-622	521743	Flintridge Pro (K-1152)	Gravel / CX	487	
		529700	Gabbro (K-1266)	Gravel / CX	488	
		529259	Khan II (K-1172)	Trekking / City	510	
	37-622	529006				
		529005				
		521736	Small Block Eight (K-1047)	Gravel / CX	487	
		529348	Krosscyclo (K-161)	Gravel / CX	488	
		527774	Khan (K-935)	Trekking / City	507	
		520535				
		529651				
		520534				
		520530				
		528112	Klondike (K-1014)	Trekking / City	515	
700 x 38 C	40-622	529389	Khan (K-935)	Trekking / City	507	
		527510				
		529016				
		529392	Khan (K-935)	Trekking / City	508	
		529393				
		529394				
		529395				
		529396				
		529397				
		529398				
		529399				
		520532				
		529018	Eurotrek (K-197)	Trekking / City	511	
		527773				
		529165				



	GRÖSSE SIZE	ETRTO NR. ETRTO NO.	ART.-NR. ART. NO.	PROFIL TREAD	TYP TYPE	SEITE PAGE	
<b>28"</b>	700 x 40 C	40-622	521760	Alluvium (K-1226)	Gravel / CX	486	
			521766				
			521768	Booster Pro (K-1227)	Gravel / CX	486	
			521746	Flintridge Pro (K-1152)	Gravel / CX	487	
			521747				
			523337	Flintridge Elite (K-1152)	Gravel / CX	488	
			529701	Gabbro (K-1266)	Gravel / CX	488	
			527988	Kwick Journey (K-1129)	Trekking / City	511	
			529331	Khan (K-935)	Trekking / City	508	
		529087					
		529652					
		520533					
		520531					
		529258	Khan II (K-1172)	Trekking / City	510		
		529090					
		529009					
		529010					
		528113	Klondike (K-1014)	BMX / Dirt / Kid	515		
			700 x 45 C 28 x 1.75	45-622	521761	Alluvium (K-1226)	Gravel / CX
521765							
529257	Khan II (K-1172)				Trekking / City	510	
529012							
47-622	529008						
	529654			Khan (K-935)	Trekking / City	508	
	529015						
	529511						
	529177						
	529176						
	700 x 50 C	50-622	529011	Khan II (K-1172)	Trekking / City	510	
<b>27.5"</b>	650 B x 1.35 27.5 x 1.35	34-584	520546	Kwest (K-193)	Trekking / City	512	
	650 B x 1.75 27.5 x 1.75	45-584	523958	Koast (K-1082)	Trekking / City	512	
	650 B x 1.95 27.5 x 1.95	50-584	529473	Aptor (K-1153)	MTB	504	
	650 B x 2.10 27.5 x 2.10	54-584	528118	Klondike Elite (K-1013)	MTB	503	
			528117	Klondike Sport (K-1013)	MTB	503	
		53-584	520903	Khan II (K-1172)	Trekking / City	511	
			52-584	520541	Kadre (K-1027)	MTB	498
				523327	Small Block Eight Sport (K-1047)	MTB	500
				529073	50 Fifty (K-1104A)	MTB	501
				529270	Khan (K-935)	Trekking / City	509
650 B x 2.20 27.5 x 2.20	54-584	520545	Kadre Sport Protect (K-1027)	MTB	497		
650 B x 2.35 27.5 x 2.35	56-584	529697	Kadre (K-1027)	MTB	498		

	GRÖSSE SIZE	ETRTO NR. ETRTO NO.	ART.-NR. ART. NO.	PROFIL TREAD	TYP TYPE	SEITE PAGE
<b>27.5"</b>	<b>650 B x 2.40 27.5 x 2.40</b>	<b>60-584</b>	<b>521968</b>	Helldiver Pro (K-1202)	MTB	489
			<b>521967</b>			
			<b>521969</b>	Hellkat Pro (K-1201)	MTB	491
			<b>521964</b>			
			<b>521966</b>			
			<b>521965</b>			
		<b>61-584</b>	<b>521984</b>	Gran Mudda Pro (K-1235)	MTB	492
			<b>521960</b>	Nevegal <sup>2</sup> Pro (K-1211)	MTB	496
			<b>521998</b>	Pinner Pro (K-1241A)	MTB	492
			<b>521999</b>			
			<b>521975</b>	Regolith Pro (K-1214)	MTB	493
			<b>520979</b>	Karma 2 Pro (K-1237)	MTB	494
		<b>529674</b>	Amrak (K-1247)	MTB	498	
	<b>650 B x 2.60 27.5 x 2.60</b>	<b>66-584</b>	<b>528234</b>	Hellkat Pro (K-1201E)	MTB	490
			<b>521961</b>	Hellkat Pro (K-1201)	MTB	491
<b>520909</b>			Kadre (K-1027)	MTB	498	
<b>650 B x 2.80 27.5 x 2.80</b>	<b>71-584</b>	<b>528232</b>	Havok Pro (K-1184A)	MTB	489	
		<b>523365</b>	Havok Sport (K-1184A)	MTB	489	
		<b>529271</b>	Kadre (K-1027)	MTB	498	
<b>27"</b>	<b>27 x 1 1/4</b>	<b>32-630</b>	<b>520574</b>	(K-103)	Trekking / City	514
<b>26"</b>	<b>26 x 1.25</b>	<b>32-559</b>	<b>521824</b>	Kwick Roller Sport (K-1029)	Trekking / City	512
	<b>26 x 1 3/8</b>	<b>37-590</b>	<b>529055</b>	Kourier (K-192)	Trekking / City	513
			<b>524717</b>	(K-184)	Trekking / City	513
			<b>524705</b>	(K-133)	Trekking / City	513
	<b>26 x 1.50</b>	<b>40-559</b>	<b>520566</b>	Kwest (K-193)	Trekking / City	512
		<b>26 x 1.50 x 1 3/8</b>	<b>37-584</b>	<b>525801</b>	(K-184)	Trekking / City
	<b>26 x 1.75</b>	<b>47-559</b>	<b>529127</b>	(K-831A)	MTB	505
			<b>529364</b>	Khan (K-935)	Trekking / City	509
			<b>529093</b>			
			<b>529095</b>			
			<b>529126</b>			
			<b>529125</b>			
<b>26 x 1.75 x 2.00</b>	<b>47-559</b>	<b>529092</b>	Khan II (K-1172)	Trekking / City	511	
		<b>527613</b>	(K-127)	Trekking / City	513	
<b>26 x 1.95</b>	<b>50-559</b>	<b>523718</b>	Small Block Eight Elite (K-1047)	MTB	500	
		<b>528110</b>	Klondike (K-946)	MTB	503	
		<b>529308</b>	Aptor (K-1153)	MTB	504	
		<b>529130</b>	(K-829)	MTB	504	
		<b>527620</b>				
		<b>529132</b>				
		<b>529195</b>				
		<b>529134</b>				
		<b>529133</b>				
		<b>529131</b>				
<b>529687</b>						

	GRÖSSE SIZE	ETRTO NR. ETRTO NO.	ART.-NR. ART. NO.	PROFIL TREAD	TYP TYPE	SEITE PAGE
<b>26"</b>	26 x 1.95	50-559	520525	(K-831A)	MTB	505
			529695	(K-898)	MTB	505
			520520			
			520523	Kwick (K-879)	MTB	506
			529266	(K-948)	MTB	506
			520521	Kross Plus (K-847)	MTB	506
			520528	(K-90)	MTB	506
			529091	Khan (K-935)	Trekking / City	509
			529044			
	529144					
	529007	Khan II (K-1172)	Trekking / City	511		
	26 x 2.00	50-559	520853	Karma Sport (K-917)	MTB	499
			529302	Kwick Drumlin Cargo (K-1216)	Cargo	514
	26 x 2.10	54-559	520572	Kadre Sport Protect (K-1027)	MTB	497
			529693	Kadre (K-1027)	MTB	498
			523717	Small Block Eight Pro (K-1047)	MTB	500
			523326	Small Block Eight Sport (K-1047)	MTB	500
			527649	50 Fifty (K-1104A)	MTB	501
			528116	Klondike Elite (K-1013)	MTB	503
520522			(K-816)	MTB	504	
529322			(K-831A)	MTB	505	
524784			(K-898)	MTB	505	
523311		Nevegal X Sport (K-1150)	MTB	496		
529027	Aptor (K-1153)	MTB	504			
26 x 2.125	57-559	520669	Flame (K-1008)	BMX / Dirt / Kid	515	
26 x 2.25	57-559	523526	Booster Pro (K-1227)	MTB	495 / 516	
		523524	3-Sixty Pro (K-1238)	BMX / Dirt / Kid	516	
26 x 2.30	58-559	529506	K-Rad (K-905)	BMX / Dirt / Kid	516	
		520733	Kiniption (K-1016)	BMX / Dirt / Kid	517	
26 x 2.35	58-559	523315	Nevegal X Sport (K-1150)	MTB	496	
		523784	Blue Groove (K-1012)	MTB	497	
26 x 2.40	61-559	529477	Kwick Drumlin Cargo (K-1216)	Cargo	514	
26 x 2.50	62-559	523714	Nevegal (K-1010)	MTB	496	
26 x 3.00	68-559	523738	Flame (K-1008A)	BMX / Dirt / Kid	515	
26 x 4.00	98-559	528221	Juggernaut Pro (K-1151)	Fat Bike / Snow	502	
		528220	Juggernaut Sport (K-1151)	Fat Bike / Snow	502	
		528209	Gigas (K-1167)	Fat Bike / Snow	502	
26 x 4.50	116-559	528222	Juggernaut Sport (K-1151)	Fat Bike / Snow	502	
<b>24"</b>	24 x 1 3/8	37-540	529053	Kourier (K-192)	Trekking / City	513
	24 x 1.75	47-507	520501	Khan (K-935)	Trekking / City	509
			529004	Khan II (K-1172)	Trekking / City	511
	24 x 1.95	50-507	529616	(K-829)	MTB	505
			529119			
529038						
529039						
529243						



	GRÖSSE SIZE	ETRTO NR. ETRTO NO.	ART.-NR. ART. NO.	PROFIL TREAD	TYP TYPE	SEITE PAGE	
24"	24 x 1.95	50-507	529334 529115	Aptor (K-1153) (K-831A)	BMX / Dirt / Kid BMX / Dirt / Kid	518 518	
	24 x 2.00	50-507	529301	Kwick Drumlin Cargo (K-1216)	Cargo	514	
	24 x 2.20	56-507	529336	Amrak (K-1247)	MTB	498 / 517	
	24 x 2.30	58-507	523426	K-Rad (K-905)	BMX / Dirt / Kid	516	
	24 x 2.60	66-507	520919	Slant Six Sport (K-1080)	BMX / Dirt / Kid	517	
20"	20 x 1.75	44-406 47-406	529003 529105 520505	Khan II (K-1172) Khan (K-935) (K-50)	Trekking / City Trekking / City BMX / Dirt / Kid	511 509 518	
	20 x 1.95	50-406	529600 529602 529603 529604 529605 529606 529607 529608	Krackpot (K-907)	BMX / Dirt / Kid	519	
	20 x 2.00	50-406	527027 529300	(K-829) Kwick Drumlin Cargo (K-1216)	MTB Cargo	505 514	
	20 x 2.10	54-406	527027	Kinoption (K-1016)	BMX / Dirt / Kid	517	
	20 x 2.125	57-406	529109	(K-50)	BMX / Dirt / Kid	518	
	20 x 2.20	56-406	529335	Amrak (K-1247)	MTB	498 / 517	
	20 x 2.25	58-406	525090 525091 525092 523014	(K-51)   Krackpot (K-907)	BMX / Dirt / Kid   BMX / Dirt / Kid	518   519	
	20 x 2.35	58-406	529102	K-Rad (K-905)	BMX / Dirt / Kid	516	
	20 x 2.40	61-406	529475	Kwick Drumlin Cargo (K-1216)	Cargo	514	
	20 x 2.60	66-406	520918	Slant Six Sport (K-1080)	BMX / Dirt / Kid	517	
	18"	18 x 1.75	47-355	520500	Khan (K-935)	Trekking / City	509
	16"	16 x 1.75	47-305	529100 529099	Khan (K-935) (K-853)	Trekking / City BMX / Kid	509 519
	14"	14 x 1.75	47-254	529433	(K-149)	BMX / Kid	519
12"	12 1/2 x 1.75 x 2 1/4	47-203	529184	(K-909A)	BMX / Kid	520	
	12 1/2 x 2 1/4	62-203	520741 520742 520743 520744 520745 520746 520748 526210 529249	Khan (K-935)       Fish (K-921) (K-850)	Trekking / City       BMX / Kid BMX / Kid	509       520 520	
10"	10 x 2.00	54-152	525003	(K-909A)	BMX / Dirt / Kid	520	

ART.-NR. 	GRÖSSE SIZE	ETRTO NR. ETRTO NO.	SPEZIFIKATIONEN SPECIFICATIONS	VERPACKUNG PACKAGING
---	----------------	------------------------	-----------------------------------	-------------------------

REIFENUMFANG	TIRE CIRCUMFERENCE
--------------	--------------------

 = TCC

Reifenumfang (außen) zum Einstellen von Fahrradcomputern

Tire Circumference (outer) for setting Computers

Speed 

Grip 

Protection 

Durability 















## ›VALKYRIE‹ K-1160

**BEST ROAD TIRE**

Testurteil **RoadBIKE**  
**Sehr gut**







›VALKYRIE PRO TLR‹			›VALKYRIE PRO TLR‹		
<b>521752</b> 20 ★★★★★	<b>700 x 25 C</b>	25-622	<ul style="list-style-type: none"> <li>• 120 TPI</li> <li>• Kevlar faltbar Kevlar folded</li> <li>• R3C</li> <li>• TLR (Tubeless Ready)</li> <li>• Reflective Hot Patch (RHP) für bessere Sichtbarkeit / for better visibility</li> <li>• nur / only 257 g</li> <li>• TCC: 2.139 mm</li> </ul>	  	Eurolochkarte eurohole card   UVP 75,90 €
<b>521753</b> 20 ★★★★★	<b>700 x 28 C</b>	28-622	<ul style="list-style-type: none"> <li>• 120 TPI</li> <li>• Kevlar faltbar Kevlar folded</li> <li>• R3C</li> <li>• TLR (Tubeless Ready)</li> <li>• Reflective Hot Patch (RHP) für bessere Sichtbarkeit / for better visibility</li> <li>• nur / only 298 g</li> <li>• TCC: 2.129 mm</li> </ul>	  	Eurolochkarte eurohole card   UVP 75,90 €
›VALKYRIE PRO‹			›VALKYRIE PRO‹		
<b>521758</b> 20 ★★★★★	<b>700 x 25 C</b>	25-622	<ul style="list-style-type: none"> <li>• 120 TPI</li> <li>• Kevlar faltbar Kevlar folded</li> <li>• R3C</li> <li>• KA (K-Armor)</li> <li>• Reflective Hot Patch (RHP) für bessere Sichtbarkeit / for better visibility</li> <li>• nur / only 182 g</li> <li>• TCC: 2.130 mm</li> </ul>	  	Eurolochkarte eurohole card   UVP 55,90 €
<b>521759</b> 20 ★★★★★	<b>700 x 28 C</b>	28-622	<ul style="list-style-type: none"> <li>• 120 TPI</li> <li>• Kevlar faltbar Kevlar folded</li> <li>• R3C</li> <li>• KA (K-Armor)</li> <li>• Reflective Hot Patch (RHP) für bessere Sichtbarkeit / for better visibility</li> <li>• nur / only 242 g</li> <li>• TCC: 2.155 mm</li> </ul>	  	Eurolochkarte eurohole card   UVP 57,90 €
<b>521714</b> 20 ★★★★★	<b>700 x 30 C</b>	30-622	<ul style="list-style-type: none"> <li>• 120 TPI</li> <li>• Kevlar faltbar Kevlar folded</li> <li>• R3C</li> <li>• KA (K-Armor)</li> <li>• Reflective Hot Patch (RHP) für bessere Sichtbarkeit / for better visibility</li> <li>• nur / only 265 g</li> <li>• TCC: 2.168 mm</li> </ul>	  	Eurolochkarte eurohole card   UVP 57,90 €

ART.-NR. 	GRÖSSE SIZE	ETRTO NR. ETRTO NO.	SPEZIFIKATIONEN SPECIFICATIONS		VERPACKUNG PACKAGING
<b>›VALKYRIE ELITE‹</b>			<b>›VALKYRIE ELITE‹</b>		
<b>521755</b> 20 ★★	<b>700 x 25 C</b>	25-622	<ul style="list-style-type: none"> <li>• 60 TPI</li> <li>• Kevlar faltbar Kevlar folded</li> <li>• R3C</li> <li>• ICP</li> <li>• Reflective Hot Patch (RHP) für bessere Sichtbarkeit / for better visibility</li> <li>• nur 222 g only 222 g</li> <li>• TCC: 2.130 mm</li> </ul>	  	Eurolochkarte eurohole card   UVP 43,90 €
<b>521756</b> 20 ★★	<b>700 x 28 C</b>	28-622	<ul style="list-style-type: none"> <li>• 60 TPI</li> <li>• Kevlar faltbar Kevlar folded</li> <li>• R3C</li> <li>• ICP</li> <li>• Reflective Hot Patch (RHP) für bessere Sichtbarkeit / for better visibility</li> <li>• nur 267 g only 267 g</li> <li>• TCC: 2.130 mm</li> </ul>	  	Eurolochkarte eurohole card   UVP 43,90 €
<b>›VALKYRIE SPORT‹</b>			<b>›VALKYRIE SPORT‹</b>		
<b>521718</b> 25 ★	<b>700 x 28 C</b>	28-622	<ul style="list-style-type: none"> <li>• 60 TPI</li> <li>• R3C</li> <li>• ICP</li> <li>• nur 323 g only 323 g</li> <li>• TCC: 2.155 mm</li> </ul>	 	Banderole tag   UVP 39,90 €

Speed   
 Grip   
 Protection   
 Durability 











## ›KOUNTACH‹ K-1092

<b>›KOUNTACH PRO‹</b>			<b>›KOUNTACH PRO‹</b>		
<b>521780</b> 20 ★★★	<b>700 x 23 C</b>	23-622	<ul style="list-style-type: none"> <li>• 120 TPI</li> <li>• Kevlar faltbar Kevlar folded</li> <li>• R2C</li> <li>• KA (K-Armor)</li> <li>• nur 194 g only 194 g</li> <li>• TCC: 2.112 mm</li> </ul>	 	Eurolochkarte eurohole card   UVP 49,90 €
<b>521781</b> 20 ★★★★	<b>700 x 25 C</b>	25-622	<ul style="list-style-type: none"> <li>• 120 TPI</li> <li>• Kevlar faltbar Kevlar folded</li> <li>• R2C</li> <li>• KA (K-Armor)</li> <li>• nur 209 g only 209 g</li> <li>• TCC: 2.139 mm</li> </ul>	 	Eurolochkarte eurohole card   UVP 49,90 €

ART.-NR. 	GRÖSSE SIZE	ETRTO NR. ETRTO NO.	SPEZIFIKATIONEN SPECIFICATIONS	VERPACKUNG PACKAGING
---	----------------	------------------------	-----------------------------------	-------------------------



## ›KONTENDER‹ K-196

›KONTENDER‹			›KONTENDER‹	
<b>522815</b> 20 ★★	<b>700 x 23 C</b>	23-622	<ul style="list-style-type: none"> <li>• 60 TPI</li> <li>• Kevlar faltbar / folded</li> <li>• L3R Pro</li> <li>• nur 237 g only 237 g</li> <li>• TCC: 2.124 mm</li> </ul>	 Eurolochkarte eurohole card  UVP 25,90 €
<b>522817</b> 20 ★★	<b>700 x 26 C</b>	26-622	<ul style="list-style-type: none"> <li>• 60 TPI</li> <li>• Kevlar faltbar / folded</li> <li>• L3R-Pro</li> <li>• nur 293 g only 293 g</li> <li>• TCC: 2.133 mm</li> </ul>	 Eurolochkarte eurohole card  UVP 25,90 €
›KONTENDER SPORT PROTECT‹			›KONTENDER SPORT PROTECT‹	
<b>521771</b> 25 ★	<b>700 x 26 C</b>	26-622	<ul style="list-style-type: none"> <li>• 60 TPI</li> <li>• L3R-Pro</li> <li>• Iron Cap Belt</li> <li>• nur 366 g only 366 g</li> <li>• TCC: 2.133 mm</li> </ul>	 Banderole tag  UVP 22,90 €
›KONTENDER‹			›KONTENDER‹	
<b>529660</b> 25 ★	<b>700 x 23 C</b>	23-622	<ul style="list-style-type: none"> <li>• 60 TPI</li> <li>• L3R-Pro</li> <li>• nur / only 310 g TCC: 2.124 mm</li> </ul>	 Montageverpackung OEM UVP 16,90 €
<b>529661</b> <b>529662</b> <b>529663</b> <b>529664</b> <b>529665</b> 25 ★			<ul style="list-style-type: none"> <li>• 60 TPI</li> <li>• nur 310 g only 310 g</li> <li>• TCC: 2.124 mm</li> </ul> silber / silver weiß / white rot / red blau / blue gelb / yellow	 Montageverpackung OEM UVP 15,90 €
• <b>529075</b> 25			<ul style="list-style-type: none"> <li>• nur 415 g only 415 g</li> <li>• TCC: 2.124 mm</li> </ul>	Montageverpackung OEM UVP 9,90 €

















ART.-NR. 	GRÖSSE SIZE	ETRTO NR. ETRTO NO.	SPEZIFIKATIONEN SPECIFICATIONS	VERPACKUNG PACKAGING
---	----------------	------------------------	-----------------------------------	-------------------------

GRAVEL / CX

GRAVEL / CX





## »ALLUVIUM« K-1226

<p><b>521760</b> <b>700 x 40 C</b></p> <p>10 ★ ★ ★</p> <p><b>NEW</b></p>	<p>40-622</p>	<ul style="list-style-type: none"> <li>• 120 TPI</li> <li>• Kevlar faltbar / folded</li> <li>• GCT (Gravel Casing Technology)</li> <li>• Single Tread Compound</li> <li>• Tubeless Ready</li> <li>• Reflective Hot Patch (RHP) für bessere Sichtbarkeit / for better visibility</li> <li>• nur / only 495 g</li> <li>• TCC: 2.234 mm</li> </ul>	<p><b>SINGLE TREAD</b></p> <p><b>GCT</b> </p> <p><b>RHP</b> </p>	<p>Eurolochkarte eurohole card</p>  <p>UVP 69,90 €</p>
<p><b>521766</b></p> <p>10 ★ ★ ★</p> <p><b>NEW</b></p>		<ul style="list-style-type: none"> <li>• 120 TPI</li> <li>• Kevlar faltbar / folded</li> <li>• GCT (Gravel Casing Technology)</li> <li>• Single Tread Compound</li> <li>• Tubeless Ready</li> <li>• Coffee Wall</li> <li>• nur / only 512 g</li> <li>• TCC: 2.234 mm</li> </ul>	<p><b>SINGLE TREAD</b></p> <p><b>GCT</b> </p>  <p><b>COFFEE WALL</b></p>	<p>Eurolochkarte eurohole card</p>  <p>UVP 69,90 €</p>
<p><b>521761</b> <b>700 x 45 C</b></p> <p>10 ★ ★ ★</p> <p><b>NEW</b></p>	<p>45-622</p>	<ul style="list-style-type: none"> <li>• 120 TPI</li> <li>• Kevlar faltbar / folded</li> <li>• GCT (Gravel Casing Technology)</li> <li>• Single Tread Compound</li> <li>• Tubeless Ready</li> <li>• Reflective Hot Patch (RHP) für bessere Sichtbarkeit / for better visibility</li> <li>• nur / only 558 g</li> <li>• TCC: 2.262 mm</li> </ul>	<p><b>SINGLE TREAD</b></p> <p><b>GCT</b> </p> <p><b>RHP</b> </p>	<p>Eurolochkarte eurohole card</p>  <p>UVP 69,90 €</p>
<p><b>521765</b></p> <p>10 ★ ★ ★</p> <p><b>NEW</b></p>		<ul style="list-style-type: none"> <li>• 120 TPI</li> <li>• Kevlar faltbar / folded</li> <li>• GCT (Gravel Casing Technology)</li> <li>• Single Tread Compound</li> <li>• Tubeless Ready</li> <li>• Coffee Wall</li> <li>• nur / only 512 g</li> <li>• TCC: 2.262 mm</li> </ul>	<p><b>SINGLE TREAD</b></p> <p><b>GCT</b> </p>  <p><b>COFFEE WALL</b></p>	<p>Eurolochkarte eurohole card</p>  <p>UVP 69,90 €</p>



















## »BOOSTER PRO« K-1227

BEST SPEED CONTROL

<p><b>521768</b> <b>700 x 40 C</b></p> <p>10 ★ ★ ★</p>	<p>40-622</p>	<ul style="list-style-type: none"> <li>• 120 TPI</li> <li>• Kevlar faltbar / folded</li> <li>• Tubeless Race</li> <li>• Single Tread Compound</li> <li>• nur / only 371 g</li> <li>• TCC: 2.237 mm</li> </ul>	<p><b>SINGLE TREAD</b></p> <p><b>TRQ</b> </p>	<p>Eurolochkarte eurohole card</p>  <p>UVP 69,90 €</p>
--	---------------	---	--	---

ART.-NR. 	GRÖSSE SIZE	ETRTO NR. ETRTO NO.	SPEZIFIKATIONEN SPECIFICATIONS	VERPACKUNG PACKAGING
Speed  Grip  Protection  Durability 			<h3>›SMALL BLOCK EIGHT‹</h3> <h2>K-1047</h2>	
<b>521735</b> 20 ★ ★	<b>700 x 32 C</b>	32-622	<ul style="list-style-type: none"> <li>• 60 TPI</li> <li>• Kevlar faltbar / folded</li> <li>• DTC</li> <li>• nur / only 340 g</li> <li>• TCC: 2.180 mm</li> </ul>	 Eurolochkarte eurohole card  UVP 33,90 €
<b>521736</b> 20 ★ ★	<b>700 x 35 C</b>	37-622	<ul style="list-style-type: none"> <li>• 60 TPI</li> <li>• Kevlar faltbar / folded</li> <li>• DTC</li> <li>• nur / only 378 g</li> <li>• TCC: 2.190 mm</li> </ul>	 Eurolochkarte eurohole card  UVP 34,90 €

Speed  Grip  Protection  Durability 			<h3>›FLINTRIDGE‹</h3> <h2>K-1152</h2>	
<h4>›FLINTRIDGE PRO‹</h4>				
<b>521743</b> 20 ★ ★ ★	<b>700 x 35 C</b>	35-622	<ul style="list-style-type: none"> <li>• 120 TPI</li> <li>• Kevlar faltbar / folded</li> <li>• GCT (Gravel Casing Technology)</li> <li>• DTC</li> <li>• Tubeless Ready</li> <li>• Reflective Hot Patch (RHP) für bessere Sichtbarkeit / for better visibility</li> <li>• nur / only 481 g</li> <li>• TCC: 2.218 mm</li> </ul>	   Eurolochkarte eurohole card  UVP 62,90 €
<b>521746</b> 10 ★ ★ ★	<b>700 x 40 C</b>	40-622	<ul style="list-style-type: none"> <li>• 120 TPI</li> <li>• Kevlar faltbar / folded</li> <li>• GCT (Gravel Casing Technology)</li> <li>• DTC</li> <li>• Tubeless Ready</li> <li>• Reflective Hot Patch (RHP) für bessere Sichtbarkeit / for better visibility</li> <li>• nur / only 515 g</li> <li>• TCC: 2.231 mm</li> </ul>	   Eurolochkarte eurohole card  UVP 65,90 €
<b>521747</b> 10 ★ ★ ★			<ul style="list-style-type: none"> <li>• 120 TPI</li> <li>• Kevlar faltbar / folded</li> <li>• GCT (Gravel Casing Technology)</li> <li>• Tubeless Ready</li> <li>• Coffee Wall</li> <li>• nur / only 501 g</li> <li>• TCC: 2.231 mm</li> </ul>	   Eurolochkarte eurohole card  UVP 62,90 €

ART.-NR. 	GRÖSSE SIZE	ETRTO NR. ETRTO NO.	SPEZIFIKATIONEN SPECIFICATIONS	FLINTRIDGE K-1152	VERPACKUNG PACKAGING
›FLINTRIDGE ELITE‹			›FLINTRIDGE ELITE‹		
523337 20 ★ ★	700x40 C	40-622	<ul style="list-style-type: none"> <li>• 60 TPI</li> <li>• Kevlar faltbar / folded</li> <li>• L3R Pro</li> <li>• Reflective Hot Patch (RHP) für bessere Sichtbarkeit / for better visibility</li> <li>• nur / only 468 g</li> <li>• TCC: 2.231 mm</li> </ul>	 	Eurolochkarte eurohole card   UVP 33,90 €



›GABBRO‹  
K-1266

529700 25 NEW	700 x 35 C	35-622	<ul style="list-style-type: none"> <li>• 30 TPI</li> <li>• nur / only 474 g</li> <li>• TCC: 2.199 mm</li> </ul>	Montageverpackung OEM	UVP 14,90 €
529701 25 NEW	700 x 40 C	40-622	<ul style="list-style-type: none"> <li>• 30 TPI</li> <li>• nur / only 503 g</li> <li>• TCC: 2.234 mm</li> </ul>	Montageverpackung OEM	UVP 16,90 €



›KROSSCYCLO‹  
K-161

529348 25 ★	700 x 35 C	37-622	<ul style="list-style-type: none"> <li>• 30 TPI</li> <li>• nur / only 420 g</li> <li>• TCC: 2.174 mm</li> </ul>	Montageverpackung OEM	UVP 11,90 €
-------------------	------------	--------	---	--------------------------	-------------



›KWICK‹  
K-879

529180 25	700 x 30 C	30-622	<ul style="list-style-type: none"> <li>• TCC: 2.158 mm</li> </ul>	Montageverpackung OEM	UVP 11,90 €
--------------	------------	--------	---	--------------------------	-------------



ART.-NR. 	GRÖSSE SIZE	ETRTO NR. ETRTO NO.	SPEZIFIKATIONEN SPECIFICATIONS	VERPACKUNG PACKAGING
--	----------------	------------------------	-----------------------------------	-------------------------







MTB



MTB

- Speed 
- Grip 
- Protection 
- Durability 



## ›HAVOK‹ K-1184A

›HAVOK PRO‹			›HAVOK PRO‹		
<b>528232</b> 10  	<b>650 B x 2.80</b> <b>27.5 x 2.80</b> <b>PLUS</b>	71-584	<ul style="list-style-type: none"> <li>• 120 TPI</li> <li>• Kevlar faltbar / folded</li> <li>• EMC (Electric-Mountainbike Casing)</li> <li>• E-Bike zertifiziert bis 50 km/h (ECE-R75) e-bike certified up to 50 km/h (ECE-R75)</li> <li>• DTC</li> <li>• Tubeless Ready</li> <li>• nur / only 898 g</li> <li>• TCC: 2.275 mm</li> </ul>	  	Eurolochkarte eurohole card  UVP 81,90 €



›HAVOK SPORT‹			›HAVOK SPORT‹		
<b>523365</b> 25 	<b>650 B x 2.80</b> <b>27.5 x 2.80</b> <b>PLUS</b>	71-584	<ul style="list-style-type: none"> <li>• 60 TPI</li> <li>• DTC</li> <li>• nur / only 1.008 g</li> <li>• TCC: 2.275 mm</li> </ul>		Banderole tag  UVP 42,90 €

- Speed 
- Grip 
- Protection 
- Durability 



## ›HELLDIVER PRO‹ K-1202

FASTEST GRAVITY REARWHEEL TIRE

- CLEMENS KAUDELA 
- RUSO BROS 
- NS BIKE UR TEAM 

<b>521972</b> 10 	<b>29 x 2.40</b>	60-622	<ul style="list-style-type: none"> <li>• 120 TPI</li> <li>• Kevlar faltbar / folded</li> <li>• ATC (Advanced Trail Casing)</li> <li>• Tubeless Ready</li> <li>• Dual Tread</li> <li>• nur / only 942 g</li> <li>• TCC: 2.334 mm</li> </ul>	 	Eurolochkarte eurohole card  UVP 71,90 €
<b>521968</b> 10 	<b>650 B x 2.40</b> <b>27.5 x 2.40</b>	60-584	<ul style="list-style-type: none"> <li>• 120 TPI</li> <li>• Kevlar faltbar / folded</li> <li>• ATC (Advanced Trail Casing)</li> <li>• Tubeless Ready</li> <li>• Dual Tread</li> <li>• nur / only 737 g</li> <li>• TCC: 2.224 mm</li> </ul>	 	Eurolochkarte eurohole card  UVP 71,90 €
<b>521967</b> 10 	<b>650 B x 2.40</b> <b>27.5 x 2.40</b>	60-584	<ul style="list-style-type: none"> <li>• 60 TPI</li> <li>• Kevlar faltbar / folded</li> <li>• AGC (Advanced Gravity Casing)</li> <li>• Tubeless Ready</li> <li>• RSR Dual Layer</li> <li>• nur / only 972 g</li> <li>• TCC: 2.213 mm</li> </ul>	 	Eurolochkarte eurohole card  UVP 75,90 €

ART.-NR. 	GRÖSSE SIZE	ETRTO NR. ETRTO NO.	SPEZIFIKATIONEN SPECIFICATIONS	VERPACKUNG PACKAGING
---	----------------	------------------------	-----------------------------------	-------------------------











Speed   
Grip   
Protection   
Durability 



## HELLKAT PRO<sup>®</sup> K-1201E



MARCO AURELIO FONTANA 

<p><b>528235</b></p> <p>10</p> <p></p> <p></p>	<p><b>29 x 2.60</b></p>	<p>66-622</p>	<ul style="list-style-type: none"> <li>• 60 TPI</li> <li>• Kevlar faltbar / folded</li> <li>• EMC</li> <li>• Dual Tread Gummimischung (für Speed (Mitte) und Grip (außen)) Dual Tread rubber compound (for speed (center) and grip (shoulder))</li> <li>• Tubeless Ready</li> <li>• E-Bike zertifiziert bis 50 km/h (ECE-R75) e-bike certified up to 50 km/h (ECE-R75)</li> <li>• nur / only 1.120 g</li> <li>• TCC: 2.384 mm</li> </ul>	<p><b>DUAL TREAD</b></p> <p></p> <p></p>	<p>Eurolochkarte eurohole card</p> <p></p> <p>UVP 72,90 €</p>
<p><b>528234</b></p> <p>10</p> <p></p> <p></p>	<p><b>650 B x 2.60</b> <b>27.5 x 2.60</b></p>	<p>66-584</p>	<ul style="list-style-type: none"> <li>• 60 TPI</li> <li>• Kevlar faltbar / folded</li> <li>• EMC</li> <li>• Dual Tread Gummimischung (für Speed (Mitte) und Grip (außen)) Dual Tread rubber compound (for speed (center) and grip (shoulder))</li> <li>• Tubeless Ready</li> <li>• E-Bike zertifiziert bis 50 km/h (ECE-R75) e-bike certified up to 50 km/h (ECE-R75)</li> <li>• nur / only 1.053 g</li> <li>• TCC: 2.271 mm</li> </ul>	<p><b>DUAL TREAD</b></p> <p></p> <p></p>	<p>Eurolochkarte eurohole card</p> <p></p> <p>UVP 72,90 €</p>

Speed   
Grip   
Protection   
Durability 









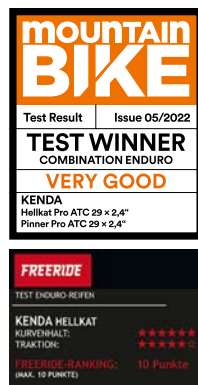

## HELLKAT PRO<sup>®</sup> K-1201

















BEST GRAVITY TIRE

TOM OEHLER 

NS BIKE UR TEAM 



<p><b>521962</b></p> <p>10</p> <p></p>	<p><b>29 x 2.40</b></p>	<p>60-622</p>	<ul style="list-style-type: none"> <li>• 120 TPI</li> <li>• Kevlar faltbar / folded</li> <li>• ATC (Advanced Trail Casing)</li> <li>• Dual Tread</li> <li>• Tubeless Ready</li> <li>• nur / only 874 g</li> <li>• TCC: 2.350 mm</li> </ul>	<p><b>DUAL TREAD</b></p> <p></p>	<p>Eurolochkarte eurohole card</p> <p></p> <p>UVP 71,90 €</p>
<p><b>521973</b></p> <p>10</p> <p></p>			<ul style="list-style-type: none"> <li>• 60 TPI</li> <li>• Kevlar faltbar / folded</li> <li>• AEC (Advanced Enduro Casing)</li> <li>• RSR Dual Layer</li> <li>• Tubeless Ready</li> <li>• nur / only 1096 g</li> <li>• TCC: 2.350 mm</li> </ul>	<p><b>AEC</b></p> <p><b>RSR</b></p>	<p>Eurolochkarte eurohole card</p> <p></p> <p>UVP 77,90 €</p>
<p><b>521963</b></p> <p>10</p> <p></p>	<p><b>29 x 2.60</b></p>	<p>66-622</p>	<ul style="list-style-type: none"> <li>• 120 TPI</li> <li>• Kevlar faltbar / folded</li> <li>• ATC (Advanced Trail Casing)</li> <li>• Dual Tread</li> <li>• Tubeless Ready</li> <li>• nur / only 1.039 g</li> <li>• TCC: 2.384 mm</li> </ul>	<p><b>DUAL TREAD</b></p> <p></p>	<p>Eurolochkarte eurohole card</p> <p></p> <p>UVP 71,90 €</p>

ART.-NR. 	GRÖSSE SIZE	ETRTO NR. ETRTO NO.	SPEZIFIKATIONEN SPECIFICATIONS	VERPACKUNG PACKAGING
521969 10 ★★★★	650 B x 2.40 27.5 x 2.40	60-584	<ul style="list-style-type: none"> <li>• 60 TPI</li> <li>• Kevlar faltbar / folded</li> <li>• AEC (Advanced Enduro Casing)</li> <li>• RSR Dual Layer</li> <li>• Tubeless Ready</li> <li>• nur / only 1010 g</li> <li>• TCC: 2.224 mm</li> </ul>	  Eurolochkarte eurohole card  UVP 74,90 €
521964 10 ★★★★			<ul style="list-style-type: none"> <li>• 60 TPI</li> <li>• Kevlar faltbar / folded</li> <li>• AGC (Advanced Gravity Casing)</li> <li>• Tubeless Ready</li> <li>• RSR Dual Layer</li> <li>• nur / only 1.144 g</li> <li>• TCC: 2.224 mm</li> </ul>	  Eurolochkarte eurohole card  UVP 74,90 €
521966 10 ★★★★			<ul style="list-style-type: none"> <li>• 60 TPI</li> <li>• AGC (Advanced Gravity Casing)</li> <li>• Tubeless Ready</li> <li>• RSR Dual Layer</li> <li>• nur / only 1.170 g</li> <li>• TCC: 2.224 mm</li> </ul>	  Banderole tag  UVP 74,90 €
521965 10 ★★★★			<ul style="list-style-type: none"> <li>• 120 TPI</li> <li>• Kevlar faltbar / folded</li> <li>• ATC (Advanced Trail Casing)</li> <li>• Tubeless Ready</li> <li>• Dual Tread</li> <li>• nur / only 880 g</li> <li>• TCC: 2.243 mm</li> </ul>	  Eurolochkarte eurohole card  UVP 74,90 €
521961 10 ★★★★	650 B x 2.60 27.5 x 2.60	66-584	<ul style="list-style-type: none"> <li>• 120 TPI</li> <li>• Kevlar faltbar / folded</li> <li>• ATC (Advanced Trail Casing)</li> <li>• Tubeless Ready</li> <li>• Dual Tread</li> <li>• nur / only 958 g</li> <li>• TCC: 2.271 mm</li> </ul>	  Eurolochkarte eurohole card  UVP 74,90 €

### MARATHON/XC TEST

**Regolith Pro** **Booster Pro**  
(Art. 521956) (Art. 521301)

### TRAIL TEST

**Hellkat Pro** **Nevegal<sup>2</sup> Pro**  
(Art. 521965) (Art. 521960)

# KENDA

#### Perfekte Kombination für Marathon und Trail

Die renommierte MTB-Zeitschrift „BIKE“ testete in der Ausgabe 8/2019 Reifenpaare für Marathon / XC und Trail. Das Ergebnis: Kenda hat die aktuellen Trends erkannt und bietet zwei echte Traumpaare. Im Marathonbereich sorgten der Regolith Pro vorne und der Booster Pro hinten für hervorragenden Grip unter allen Bedingungen, ohne dabei Rollwiderstand und Pannenschutz außer Acht zu lassen. Dies überzeugte die Redaktion und das

#### Perfect match for marathon and trail

The well-known MTB magazine "BIKE" tested tire pairs for Marathon / XC and Trail in issue 8/2019. The result: Kenda has recognized the current trends and offers two real dream teams. For marathon use, Regolith Pro at the front and Booster Pro at the rear provided excellent grip in all conditions, without neglecting rolling resistance and puncture protection. This convinced the editors and the test verdict was very pleasing with "very good"

Testurteil fiel mit „sehr gut“ und „super“ sehr erfreulich aus. Noch besser der Trailreifen – Test: die Kombi aus Hellkat Pro vorne und Nevegal<sup>2</sup> Pro hinten erhielt den BIKE-Tipp für Pannenschutz! Neben den sehr guten Fahreigenschaften hinterließ insbesondere der Pannenschutz bleibenden Eindruck mit Bestwerten im Testfeld. Insgesamt ein überragender Auftritt der aktuellsten Kenda Modelle!

and "super".

The trail tire – test was even better: the combination of Hellkat Pro front and Nevegal<sup>2</sup> Pro on the rear received the BIKE tip for puncture protection! In addition to the very good handling characteristics, in particular the puncture protection left lasting impression with best values in the test field. Overall, an outstanding performance of the latest Kenda models!

ART.-NR. 	GRÖSSE SIZE	ETRTO NR. ETRTO NO.	SPEZIFIKATIONEN SPECIFICATIONS	VERPACKUNG PACKAGING
---	----------------	------------------------	-----------------------------------	-------------------------

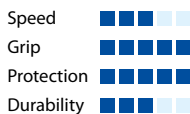







## »GRAN MUDDA PRO« K-1235

MUD / GRAVITY

MARCO AURELIO FONTANA 

NS BIKE UR TEAM 

<p><b>521986</b></p> <p>10</p> <p>★ ★ ★</p>	<p><b>29 x 2.40</b></p>	<p>61-622</p>	<ul style="list-style-type: none"> <li>• 60 TPI</li> <li>• Kevlar faltbar / folded</li> <li>• AGC (Advanced Gravity Casing)</li> <li>• Tubeless Ready</li> <li>• RSR Dual Layer</li> <li>• nur / only 1.234 g</li> <li>• TCC: 2.356 mm</li> </ul>	 	<p>Eurolochkarte eurohole card</p>  <p>UVP 81,90 €</p>
<p><b>521984</b></p> <p>10</p> <p>★ ★ ★</p>	<p><b>650 B x 2.40</b> <b>27.5 x 2.40</b></p>	<p>60-584</p>	<ul style="list-style-type: none"> <li>• 60 TPI</li> <li>• Kevlar faltbar / folded</li> <li>• AGC (Advanced Gravity Casing)</li> <li>• Tubeless Ready</li> <li>• RSR Dual Layer</li> <li>• nur / only 1.140 g</li> <li>• TCC: 2.231 mm</li> </ul>	 	<p>Eurolochkarte eurohole card</p>  <p>UVP 81,90 €</p>



## »PINNER PRO« K-1241A











DOWNHILL / ENDURO -  
BEST PUNCTURE PROTECTION

Entwickelt mit Aaron Gwin  
Developed with Aaron Gwin

RED BULL RAMPAGE  
WINNING TYRE 

BRETT RHEEDER 

NS BIKE UR TEAM 

<p><b>521996</b></p> <p>10</p> <p>★ ★ ★</p>	<p><b>29 x 2.40</b></p>	<p>61-622</p>	<ul style="list-style-type: none"> <li>• 120 TPI</li> <li>• Kevlar faltbar / folded</li> <li>• ATC (Advanced Trail Casing)</li> <li>• Tubeless Ready</li> <li>• Dual Tread</li> <li>• nur / only 990 g</li> <li>• TCC: 2.350 mm</li> </ul>	<p><b>DUAL TREAD</b></p> 		<p>Eurolochkarte eurohole card</p>  <p>UVP 82,90 €</p>
<p><b>521997</b></p> <p>10</p> <p>★ ★ ★</p>			<ul style="list-style-type: none"> <li>• 60 TPI</li> <li>• Kevlar faltbar / folded</li> <li>• AGC (Advanced Gravity Casing)</li> <li>• Tubeless Ready</li> <li>• RSR Dual Layer</li> <li>• nur / only 1.288 g</li> <li>• TCC: 2.350 mm</li> </ul>	 	<p>Eurolochkarte eurohole card</p>  <p>UVP 82,90 €</p>	
<p><b>521998</b></p> <p>10</p> <p>★ ★ ★</p>	<p><b>650 B x 2.40</b> <b>27.5 x 2.40</b></p>	<p>61-584</p>	<ul style="list-style-type: none"> <li>• 120 TPI</li> <li>• Kevlar faltbar / folded</li> <li>• ATC (Advanced Trail Casing)</li> <li>• Tubeless Ready</li> <li>• Dual Tread</li> <li>• nur / only 917 g</li> <li>• TCC: 2.240 mm</li> </ul>	<p><b>DUAL TREAD</b></p> 	<p>Eurolochkarte eurohole card</p>  <p>UVP 82,90 €</p>	
<p><b>521999</b></p> <p>10</p> <p>★ ★ ★</p>			<ul style="list-style-type: none"> <li>• 60 TPI</li> <li>• Kevlar faltbar / folded</li> <li>• AGC (Advanced Gravity Casing)</li> <li>• Tubeless Ready</li> <li>• RSR Dual Layer</li> <li>• nur / only 1.178 g</li> <li>• TCC: 2.240 mm</li> </ul>	 	<p>Eurolochkarte eurohole card</p>  <p>UVP 82,90 €</p>	



ART.-NR. 	GRÖSSE SIZE	ETRTO NR. ETRTO NO.	SPEZIFIKATIONEN SPECIFICATIONS	VERPACKUNG PACKAGING
--	----------------	------------------------	-----------------------------------	-------------------------









- Speed 
- Grip 
- Protection 
- Durability 



## REGOLITH PRO K-1214

BEST ALLROUNDER







<b>521956</b> 10 ★★★★	<b>29 x 2.20</b>	56-622	<ul style="list-style-type: none"> <li>• 120 TPI</li> <li>• Kevlar faltbar / folded</li> <li>• Tubeless Race</li> <li>• Dual Tread</li> <li>• nur / only 683 g</li> <li>• TCC: 2.347 mm</li> </ul>	<b>DUAL TREAD</b> 	Eurolochkarte eurohole card   UVP 74,90 €
<b>521949</b> 10 ★★★★			<ul style="list-style-type: none"> <li>• 120 TPI</li> <li>• Kevlar faltbar / folded</li> <li>• SCT</li> <li>• Dual Tread</li> <li>• nur / only 755 g</li> <li>• TCC: 2.347 mm</li> </ul>	<b>DUAL TREAD</b> 	Eurolochkarte eurohole card   UVP 74,90 €
<b>521974</b> 10 ★★★★	<b>29 x 2.40</b>	61-622	<ul style="list-style-type: none"> <li>• 120 TPI</li> <li>• Kevlar faltbar / folded</li> <li>• SCT</li> <li>• Dual Tread</li> <li>• nur / only 827 g</li> <li>• TCC: 2.372 mm</li> </ul>	<b>DUAL TREAD</b> 	Eurolochkarte eurohole card   UVP 74,90 €
<b>521975</b> 10 ★★★★	<b>650 B x 2.40 27.5 x 2.40</b>	61-584	<ul style="list-style-type: none"> <li>• 120 TPI</li> <li>• Kevlar faltbar / folded</li> <li>• SCT</li> <li>• Dual Tread</li> <li>• nur / only 785 g</li> <li>• TCC: 2.243 mm</li> </ul>	<b>DUAL TREAD</b> 	Eurolochkarte eurohole card   UVP 74,90 €



ART.-NR. 	GRÖSSE SIZE	ETRTO NR. ETRTO NO.	SPEZIFIKATIONEN SPECIFICATIONS	VERPACKUNG PACKAGING
---	----------------	------------------------	-----------------------------------	-------------------------



## »KARMA 2 PRO« K-1237

<p><b>520992</b> 29x2.20</p> <p>10 ★ ★ ★</p> <p><b>NEW</b></p>	56-622	<ul style="list-style-type: none"> <li>• 120 TPI</li> <li>• Kevlar faltbar / folded</li> <li>• Tubeless Race</li> <li>• Single Tread Compound</li> <li>• nur / only 595 g</li> <li>• TCC: 2.334 mm</li> </ul>	<p><b>SINGLE TREAD</b></p> <p><b>TRQ</b></p>	<p>Eurolochkarte eurohole card</p>  <p>UVP 73,90 €</p>
<p><b>520993</b></p> <p>10 ★ ★ ★</p> <p><b>NEW</b></p>		<ul style="list-style-type: none"> <li>• 120 TPI</li> <li>• Kevlar faltbar / folded</li> <li>• SCT</li> <li>• Single Tread Compound</li> <li>• nur / only 687 g</li> <li>• TCC: 2.334 mm</li> </ul>	<p><b>SINGLE TREAD</b></p> <p><b>SCT</b></p>	<p>Eurolochkarte eurohole card</p>  <p>UVP 73,90 €</p>
<p><b>520994</b> 29x2.40</p> <p>10 ★ ★ ★</p> <p><b>NEW</b></p>	61-622	<ul style="list-style-type: none"> <li>• 120 TPI</li> <li>• Kevlar faltbar / folded</li> <li>• Tubeless Race</li> <li>• Single Tread Compound</li> <li>• nur / only 691 g</li> <li>• TCC: 2.359 mm</li> </ul>	<p><b>SINGLE TREAD</b></p> <p><b>TRQ</b></p>	<p>Eurolochkarte eurohole card</p>  <p>UVP 73,90 €</p>
<p><b>520995</b></p> <p>10 ★ ★ ★</p> <p><b>NEW</b></p>		<ul style="list-style-type: none"> <li>• 120 TPI</li> <li>• Kevlar faltbar / folded</li> <li>• SCT</li> <li>• Single Tread Compound</li> <li>• nur / only 783 g</li> <li>• TCC: 2.359 mm</li> </ul>	<p><b>SINGLE TREAD</b></p> <p><b>SCT</b></p>	<p>Eurolochkarte eurohole card</p>  <p>UVP 73,90 €</p>
<p><b>520979</b> 650 B x 2.40 27.5 x 2.40</p> <p>10 ★ ★ ★</p> <p><b>NEW</b></p>	61-584	<ul style="list-style-type: none"> <li>• 120 TPI</li> <li>• Kevlar faltbar / folded</li> <li>• SCT</li> <li>• Single Tread Compound</li> <li>• nur / only 742 g</li> <li>• TCC: 2.237 mm</li> </ul>	<p><b>SINGLE TREAD</b></p> <p><b>SCT</b></p>	<p>Eurolochkarte eurohole card</p>  <p>UVP 73,90 €</p>



ART.-NR. 	GRÖSSE SIZE	ETRTO NR. ETRTO NO.	SPEZIFIKATIONEN SPECIFICATIONS	VERPACKUNG PACKAGING
--	----------------	------------------------	-----------------------------------	-------------------------



*Bester Kompromiss hinsichtlich Traktion, Geschwindigkeit, Beschleunigung, Grip und Belastbarkeit!  
Best compromise regarding traction, speed, acceleration, grip and endurance!*

Speed   
Grip   
Protection   
Durability 

## BOOSTER PRO<sup>◁</sup> K-1227

**BEST SPEED CONTROL IN XC**

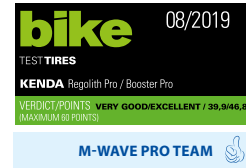





<b>521300</b> 10 ★★★★★	<b>29 x 2.20</b>	56-622	<ul style="list-style-type: none"> <li>• 120 TPI</li> <li>• Kevlar faltbar / folded</li> <li>• Tubeless Race</li> <li>• Single Tread Compound</li> <li>• nur / only 589 g</li> <li>• TCC: 2.337 mm</li> </ul>	<b>SINGLE TREAD</b> 	Eurolochkarte eurohole card   UVP 73,90 €
<b>521301</b> 10 ★★★★★			<ul style="list-style-type: none"> <li>• 120 TPI</li> <li>• Kevlar faltbar / folded</li> <li>• SCT</li> <li>• Single Tread Compound</li> <li>• nur / only 670 g</li> <li>• TCC: 2.337 mm</li> </ul>	<b>SINGLE TREAD</b> 	Eurolochkarte eurohole card   UVP 73,90 €
<b>523526</b> 20 ★★★★★	<b>26 x 2.25</b>	57-559	<ul style="list-style-type: none"> <li>• 120 TPI</li> <li>• Kevlar faltbar / folded</li> <li>• Tubeless Race</li> <li>• Single Tread Compound</li> <li>• nur / only 534 g</li> <li>• TCC: 2.143 mm</li> </ul>	<b>SINGLE TREAD</b> 	Eurolochkarte eurohole card   UVP 64,90 €



Speed   
Grip   
Protection   
Durability 

## NEVEGAL<sup>2</sup> PRO<sup>◁</sup> K-1211E

**BEST ENDURO E-BIKE 50 FOLDING**

<b>528236</b> 10 ★★★★★ 	<b>29 x 2.40</b>	60-622	<ul style="list-style-type: none"> <li>• 60 TPI</li> <li>• Kevlar faltbar / folded</li> <li>• EMC</li> <li>• Dual Tread</li> <li>• Tubeless Ready</li> <li>• E-Bike zertifiziert bis 50 km/h (ECE-R75) e-bike certified up to 50 km/h (ECE-R75)</li> <li>• nur / only 948 g</li> <li>• TCC: 2.340 mm</li> <li>• 50 % geringerer Rollwiderstand als standard Nevegal 50 % less rolling resistance than standard Nevegal</li> </ul>	<b>DUAL TREAD</b>  	Eurolochkarte eurohole card   UVP 73,90 €
--	------------------	--------	---	--	--



ART.-NR. 	GRÖSSE SIZE	ETRTO NR. ETRTO NO.	SPEZIFIKATIONEN SPECIFICATIONS	VERPACKUNG PACKAGING
---	----------------	------------------------	-----------------------------------	-------------------------



Speed	■■■■■
Grip	■■■■■
Protection	■■■■■
Durability	■■■■■



## ›NEVEGAL<sup>2</sup> PRO‹ K-1211

BEST ENDURO FOLDING IN LIGHTWEIGHT CLASS







<b>521960</b> 10 ☆☆☆	<b>650 B x 2.40</b> <b>27.5 x 2.40</b>	60-584	<ul style="list-style-type: none"> <li>• 120 TPI</li> <li>• Kevlar faltbar / folded</li> <li>• ATC (Advanced Trail Casing)</li> <li>• EN-DTC</li> <li>• Dual Tread</li> <li>• Tubeless Ready</li> <li>• nur / only 810 g</li> <li>• TCC: 2.237 mm</li> </ul>	<b>DUAL TREAD</b>  	Eurolochkarte eurohole card   UVP 67,90 €
----------------------------	---	--------	--	---	--

Speed	■■■■■
Grip	■■■■■
Protection	■■■■■
Durability	■■■■■





## ›NEVEGAL X SPORT‹ K-1150

<b>523311</b> 25 ★	<b>26 x 2.10</b>	52-559	<ul style="list-style-type: none"> <li>• 60 TPI</li> <li>• DTC</li> <li>• TCC: 2.124 mm</li> </ul>		Banderole tag   UVP 31,90 €
<b>523315</b> 25 ★	<b>26 x 2.35</b>	58-559	<ul style="list-style-type: none"> <li>• 60 TPI</li> <li>• DTC</li> <li>• TCC: 2.152 mm</li> </ul>		Banderole tag   UVP 35,90 €



## ›NEVEGAL‹ K-1010

<b>523714</b> 25 ★	<b>26 x 2.50</b>	62-559	<ul style="list-style-type: none"> <li>• 30 TPI</li> <li>• Stick-E</li> <li>• mit Butyl-Einlage / with Butyl insert</li> <li>• nur / only 1.124 g</li> <li>• TCC: 2.168 mm</li> </ul>	<b>BUTYL INSERT</b>  <b>STICK-E</b> 	Montageverpackung OEM  UVP 45,90 €
--------------------------	------------------	--------	---	---	---



ART.-NR. 	GRÖSSE SIZE	ETRTO NR. ETRTO NO.	SPEZIFIKATIONEN SPECIFICATIONS	VERPACKUNG PACKAGING
--	----------------	------------------------	-----------------------------------	-------------------------











### ›BLUE GROOVE‹ K-1012

<b>523784</b> 25 ★	<b>26 x 2.35</b>	58-559	<ul style="list-style-type: none"> <li>• 60 TPI</li> <li>• Stick-E</li> <li>• TCC: 2.152 mm</li> </ul>		Montageverpackung OEM  UVP 29,90 €
--------------------------	------------------	--------	--	--	---











### ›KADRE‹ K-1027

#### ›KADRE SPORT PROTECT‹

<b>529289</b> 25 ★	<b>29 x 2.20</b>	56-622	<ul style="list-style-type: none"> <li>• 60 TPI</li> <li>• K-Shield</li> <li>• TCC: 2.344 mm</li> </ul>			Banderole tag   UVP 24,90 €
<b>520545</b> 25 ★	<b>650 B x 2.20 27.5 x 2.20</b>	54-584	<ul style="list-style-type: none"> <li>• 60 TPI</li> <li>• K-Shield</li> <li>• TCC: 2.224 mm</li> </ul>			Banderole tag   UVP 22,90 €
<b>520572</b> 25 ★	<b>26 x 2.10</b>	54-559	<ul style="list-style-type: none"> <li>• 60 TPI</li> <li>• K-Shield</li> <li>• TCC: 2.127 mm</li> </ul>			Banderole tag   UVP 21,90 €





#### ›KADRE‹

<b>520540</b> 25 ★	<b>29 x 2.10</b>	54-622	<ul style="list-style-type: none"> <li>• 30 TPI</li> <li>• TCC: 2.325 mm</li> </ul>		Montageverpackung OEM  UVP 19,90 €
<b>529291</b> 25 ★	<b>29 x 2.40</b>	61-622	<ul style="list-style-type: none"> <li>• 30 TPI</li> <li>• TCC: 2.356 mm</li> </ul>		Montageverpackung OEM  UVP 23,90 €

ART.-NR. 	GRÖSSE SIZE	ETRTO NR. ETRTO NO.	SPEZIFIKATIONEN SPECIFICATIONS	 KADRE K-1027 	VERPACKUNG PACKAGING
<b>520541</b> 25 	<b>650 B x 2.10</b> <b>27.5 x 2.10</b>	52-584	<ul style="list-style-type: none"> <li>• 30 TPI</li> <li>• TCC: 2.205 mm</li> </ul>		Montageverpackung OEM  UVP 18,90 €
<b>529697</b> 25 	<b>650 B x 2.35</b> <b>27.5 x 2.35</b>	56-584	<ul style="list-style-type: none"> <li>• 30 TPI</li> <li>• TCC: 2.224 mm</li> </ul>		Montageverpackung OEM  UVP 19,90 €
<b>520909</b> 25 	<b>650 B x 2.60</b> <b>27.5 x 2.60</b>	66-584	<ul style="list-style-type: none"> <li>• 30 TPI</li> <li>• TCC: 2.259 mm</li> </ul>		Montageverpackung OEM  UVP 24,90 €
<ul style="list-style-type: none"> <li>• <b>529271</b></li> </ul> 25  <b>NICE PRICE</b> 	<b>650 B x 2.80</b> <b>27.5 x 2.80</b> <b>PLUS</b>	71-584	<ul style="list-style-type: none"> <li>• 30 TPI</li> <li>• TCC: 2.297 mm</li> </ul>		Montageverpackung OEM  UVP 27,90 €
<b>529693</b> 25 	<b>26 x 2.10</b>	54-559	<ul style="list-style-type: none"> <li>• 30 TPI</li> <li>• TCC: 2.127 mm</li> </ul>		Montageverpackung OEM  UVP 17,90 €



**AMRAK**  
K-1247

<b>529299</b> 25 	<b>29 x 2.20</b>	56-622	<ul style="list-style-type: none"> <li>• 30 TPI</li> <li>• nur / only 836 g</li> <li>• TCC: 2.328 mm</li> </ul>		Montageverpackung OEM  UVP 21,90 €
<b>529691</b> 25 	<b>29 x 2.60</b>	66-622	<ul style="list-style-type: none"> <li>• 30 TPI</li> <li>• nur / only 969 g</li> <li>• TCC: 2.378 mm</li> </ul>		Montageverpackung OEM  UVP 25,90 €
<b>529674</b> 25 	<b>650 B x 2.40</b> <b>27.5 x 2.40</b>	61-584	<ul style="list-style-type: none"> <li>• 30 TPI</li> <li>• nur / only 867 g</li> <li>• TCC: 2.240 mm</li> </ul>		Montageverpackung OEM  UVP 19,90 €
<b>529336</b> 25 	<b>24 x 2.20</b>	56-507	<ul style="list-style-type: none"> <li>• 30 TPI</li> <li>• nur / only 661 g</li> <li>• TCC: 2.001 mm</li> </ul>		Montageverpackung OEM  UVP 19,90 €
<b>529335</b> 25 	<b>20 x 2.20</b>	56-406	<ul style="list-style-type: none"> <li>• 30 TPI</li> <li>• nur / only 551 g</li> <li>• TCC: 1.649 mm</li> </ul>		Montageverpackung OEM  UVP 15,90 €

ART.-NR. 	GRÖSSE SIZE	ETRTO NR. ETRTO NO.	SPEZIFIKATIONEN SPECIFICATIONS	VERPACKUNG PACKAGING
--	----------------	------------------------	-----------------------------------	-------------------------











### ›KARMA SPORT‹ K-917





<b>520853</b> 25 ★	<b>26 x 2.00</b>	50-559	<ul style="list-style-type: none"> <li>• 60 TPI</li> <li>• L3R</li> <li>• nur 585 g only 585 g</li> <li>• TCC: 2.121 mm</li> </ul>		Montageverpackung OEM  UVP 20,90 €
--------------------------	------------------	--------	--	--	---



### ›RUSH PRO‹ K-1245

<b>520997</b> 10 ★★★★ NEW	<b>29 x 2.20</b>	56-622	<ul style="list-style-type: none"> <li>• 120 TPI</li> <li>• Kevlar faltbar / folded</li> <li>• Tubeless Race</li> <li>• Dual Layer Compound</li> <li>• nur / only 525 g</li> <li>• TCC: 2.344 mm</li> </ul>	<b>DUAL LAYER</b> 	Eurolochkarte eurohole card   UVP 74,90 €
<b>520999</b> 10 ★★★★ NEW			<ul style="list-style-type: none"> <li>• 120 TPI</li> <li>• Kevlar faltbar / folded</li> <li>• SCT</li> <li>• Dual Layer Compound</li> <li>• nur / only 607 g</li> <li>• TCC: 2.344 mm</li> </ul>	<b>DUAL LAYER</b> 	Eurolochkarte eurohole card   UVP 74,90 €
<b>520996</b> 10 ★★★★ NEW	<b>29 x 2.40</b>	61-622	<ul style="list-style-type: none"> <li>• 120 TPI</li> <li>• Kevlar faltbar / folded</li> <li>• Tubeless Race</li> <li>• Dual Layer Compound</li> <li>• nur / only 609 g</li> <li>• TCC: 2.353 mm</li> </ul>	<b>DUAL LAYER</b> 	Eurolochkarte eurohole card   UVP 74,90 €
<b>520998</b> 10 ★★★★ NEW			<ul style="list-style-type: none"> <li>• 120 TPI</li> <li>• Kevlar faltbar / folded</li> <li>• SCT</li> <li>• Dual Layer Compound</li> <li>• nur / only 711 g</li> <li>• TCC: 2.353 mm</li> </ul>	<b>DUAL LAYER</b> 	Eurolochkarte eurohole card   UVP 74,90 €

ART.-NR. 	GRÖSSE SIZE	ETRTO NR. ETRTO NO.	SPEZIFIKATIONEN SPECIFICATIONS	VERPACKUNG PACKAGING
---	----------------	------------------------	-----------------------------------	-------------------------

Speed   
Grip   
Protection   
Durability 



# ›SMALL BLOCK EIGHT‹ K-1047







SAM REYNOLDS 

LUCAS HUPPERT 

M-WAVE PRO TEAM 





## ›SMALL BLOCK EIGHT PRO‹

## ›SMALL BLOCK EIGHT PRO‹

<b>523747</b> 10 	<b>29 x 2.10</b>	54-622	<ul style="list-style-type: none"> <li>• 120 TPI</li> <li>• Kevlar faltbar / folded</li> <li>• DTC</li> <li>• SCT (Nutzung von Abdichtflüssigkeit möglich) SCT (Sealant Compatible Tire)</li> <li>• nur / only 689 g</li> <li>• TCC: 2.325 mm</li> </ul>	 	Eurolochkarte eurohole card   UVP 73,90 €
<b>523717</b> 20 	<b>26 x 2.10</b>	54-559	<ul style="list-style-type: none"> <li>• 120 TPI</li> <li>• Kevlar faltbar / folded</li> <li>• DTC</li> <li>• nur / only 522 g</li> <li>• TCC: 2.111 mm</li> </ul>		Eurolochkarte eurohole card   UVP 49,90 €









## ›SMALL BLOCK EIGHT ELITE‹

## ›SMALL BLOCK EIGHT ELITE‹

<b>523395</b> 10 	<b>29 x 2.10</b>	54-622	<ul style="list-style-type: none"> <li>• 60 TPI</li> <li>• Kevlar faltbar / folded</li> <li>• L3R-Pro</li> <li>• nur / only 625 g</li> <li>• TCC: 2.325 mm</li> </ul>		Eurolochkarte eurohole card   UVP 41,90 €
<b>523718</b> 25 	<b>26 x 1.95</b>	50-559	<ul style="list-style-type: none"> <li>• 60 TPI</li> <li>• Kevlar faltbar / folded</li> <li>• DTC</li> <li>• nur / only 480 g</li> <li>• TCC: 2.108 mm</li> </ul>		Montageverpackung OEM  UVP 39,90 €

## ›SMALL BLOCK EIGHT SPORT‹

## ›SMALL BLOCK EIGHT SPORT‹

<b>523329</b> 25 	<b>29 x 2.10</b>	54-622	<ul style="list-style-type: none"> <li>• 60 TPI</li> <li>• DTC</li> <li>• nur / only 723 g</li> <li>• TCC: 2.325 mm</li> </ul>		Banderole tag   UVP 28,90 €
<b>523327</b> 25 	<b>650 B x 2.10 27.5 x 2.10</b>	52-584	<ul style="list-style-type: none"> <li>• 60 TPI</li> <li>• DTC</li> <li>• nur / only 682 g</li> <li>• TCC: 2.212 mm</li> </ul>		Banderole tag   UVP 30,90 €
<b>523326</b> 25 	<b>26 x 2.10</b>	54-559	<ul style="list-style-type: none"> <li>• 60 TPI</li> <li>• DTC</li> <li>• nur / only 611 g</li> <li>• TCC: 2.111 mm</li> </ul>		Banderole tag   UVP 26,90 €



ART.-NR. 	GRÖSSE SIZE	ETRTO NR. ETRTO NO.	SPEZIFIKATIONEN SPECIFICATIONS	VERPACKUNG PACKAGING
--	----------------	------------------------	-----------------------------------	-------------------------



## ›50 FIFTY‹ K-1104A

<b>529076</b> 25 ★	<b>29 x 2.10</b>	54-622	<ul style="list-style-type: none"> <li>• 30 TPI</li> <li>• nur / only 795 g</li> <li>• TCC: 2.322 mm</li> </ul>	Montageverpackung OEM  UVP 21,90 €
<b>529073</b> 25 ★	<b>650 B x 2.10</b> <b>27.5 x 2.10</b>	52-584	<ul style="list-style-type: none"> <li>• 30 TPI</li> <li>• nur / only 719 g</li> <li>• TCC: 2.193 mm</li> </ul>	Montageverpackung OEM  UVP 18,90 €
<b>527649</b> 25 ★	<b>26 x 2.10</b>	54-559	<ul style="list-style-type: none"> <li>• 30 TPI</li> <li>• nur / only 662 g</li> <li>• TCC: 2.130 mm</li> </ul>	Montageverpackung OEM  UVP 19,90 €



ART.-NR.  

GRÖSSE  
SIZE





ETRTO NR.  
ETRTO NO.

SPEZIFIKATIONEN  
SPECIFICATIONS

VERPACKUNG  
PACKAGING

FAT TIRE

FAT TIRE

Speed   
Grip   
Protection   
Durability 



## ›JUGGERNAUT‹ K-1151

"Ein bemerkenswerter Meilenstein in der Entwicklung von FATBike Reifen"

"A remarkable milestone in the development of FATBike tires"

FAT-BIKE.DE

### ›JUGGERNAUT PRO‹

### ›JUGGERNAUT PRO‹

528221

26 x 4.00

98-559

- 120 TPI
- Kevlar faltbar / folded
- R3C
- Tubeless Race
- nur / only 808 g
- TCC: 2.366 mm



Einzelkarton  
box



6  
★ ★ ★

UVP 92,90 €

### ›JUGGERNAUT SPORT‹

### ›JUGGERNAUT SPORT‹

528220

26 x 4.00

98-559

- 60 TPI
- Fast Rolling Compound
- nur / only 1.147 g
- TCC: 2.366 mm

Banderole  
tag



10  
★

UVP 66,90 €

528222

26 x 4.50

116-559

- 60 TPI
- Fast Rolling Compound
- nur / only 1.609 g
- TCC: 2.428 mm

Banderole  
tag



10  
★

UVP 89,90 €



## ›GIGAS‹ K-1167

528209

26 x 4.00

98-559

- 60 TPI
- nur 1.352 g  
only 1,352 g
- TCC: 2.318 mm

Montageverpackung  
OEM

10  
★

UVP 52,90 €

ART.-NR. 	GRÖSSE SIZE	ETRTO NR. ETRTO NO.	SPEZIFIKATIONEN SPECIFICATIONS	VERPACKUNG PACKAGING
--	----------------	------------------------	-----------------------------------	-------------------------

**SPIKES** **STUDS**



SPIKES  
STUDS

## ›KLONDIKE‹ K-1013

**›KLONDIKE ELITE‹** **›KLONDIKE ELITE‹**

<b>528118</b> 10 ★ ★	<b>650 B x 2.10</b> <b>27.5 x 2.10</b>	54-584	<ul style="list-style-type: none"> <li>• 60 TPI</li> <li>• Kevlar faltbar / foldable</li> <li>• mit 368 Spikes / studs</li> <li>• nur / only 1.129 g</li> <li>• TCC: 2.221 mm</li> </ul>	Eurolochkarte eurohole card   UVP 83,90 €
----------------------------	---	--------	--	--

<b>528116</b> 20 ★ ★	<b>26 x 2.10</b>	54-559	<ul style="list-style-type: none"> <li>• 60 TPI</li> <li>• Kevlar faltbar / foldable</li> <li>• mit 252 Spikes / studs</li> <li>• nur / only 1.017 g</li> <li>• TCC: 2.130 mm</li> </ul>	Eurolochkarte eurohole card   UVP 77,90 €
----------------------------	------------------	--------	--	---

**›KLONDIKE‹** **›KLONDIKE‹**

<b>528115</b> 10 ★	<b>29 x 2.10</b>	54-622	<ul style="list-style-type: none"> <li>• 30 TPI</li> <li>• mit 400 Spikes / studs</li> <li>• nur / only 1.433 g</li> <li>• TCC: 2.337 mm</li> </ul>	Banderole tag   UVP 79,90 €
--------------------------	------------------	--------	---	--

<b>528117</b> 10 ★	<b>650 B x 2.10</b> <b>27.5 x 2.10</b>	54-584	<ul style="list-style-type: none"> <li>• 30 TPI</li> <li>• mit 368 Spikes / studs</li> <li>• nur / only 1.304 g</li> <li>• TCC: 2.221 mm</li> </ul>	Banderole tag   UVP 79,90 €
--------------------------	---	--------	---	--



SPIKES  
STUDS

## ›KLONDIKE‹ K-946

<b>528110</b> 10 ★	<b>26 x 1.95</b>	50-559	<ul style="list-style-type: none"> <li>• 30 TPI</li> <li>• mit 168 Spikes / studs</li> <li>• nur / only 965 g</li> <li>• TCC: 2.070 mm</li> </ul>	Banderole tag   UVP 65,90 €
--------------------------	------------------	--------	---	--

ART.-NR. 	GRÖSSE SIZE	ETRTO NR. ETRTO NO.	SPEZIFIKATIONEN SPECIFICATIONS	VERPACKUNG PACKAGING
---	----------------	------------------------	-----------------------------------	-------------------------



## K-816

<b>520522</b> 25	<b>26x2.10</b>	54-559	• TCC: 2.083 mm	Montageverpackung OEM UVP 14,90 €
---------------------	----------------	--------	-----------------	--------------------------------------



## ›APTOR‹ K-1153

›APTOR‹			›APTOR‹	
<b>529069</b> 25	<b>29x2.35</b>	55-622	• 30 TPI • TCC: 2.337 mm	Montageverpackung OEM UVP 20,90 €
<b>529473</b> 25	<b>650 B x 1.95 27.5 x 1.95</b>	50-584	• TCC: 2.174 mm	Montageverpackung OEM UVP 14,90 €
<b>529308</b> 25	<b>26x1.95</b>	50-559	• TCC: 2.111 mm	Montageverpackung OEM UVP 11,90 €
<b>529027</b> 25	<b>26x2.10</b>	52-559	• TCC: 2.127 mm	Montageverpackung OEM UVP 12,90 €





## K-829

<b>529130</b>	<b>26 x 1.95</b>	50-559	• TCC: 2.077 mm • schwarz / black	Montageverpackung OEM UVP 13,90 €
<b>529132</b> <b>527620</b> <b>NEW</b>			grau / grey schwarz/weiß / black/white	Montageverpackung OEM     UVP 15,90 €
<b>529195</b>			weiß / white	
<b>529134</b>			rot / red	
<b>529133</b>			blau / blue	
<b>529131</b>			gelb / yellow	
<b>529687</b> <b>NEW</b>	25		grün / green	





ART.-NR. 	GRÖSSE SIZE	ETRTO NR. ETRTO NO.	SPEZIFIKATIONEN SPECIFICATIONS		VERPACKUNG PACKAGING
<b>NEW</b>  529616 529119 529038 529039 529243 25	24 x 1.95	50-507	• TCC: 1.916 mm  schwarz / black  schwarz/weiß / black/white  rot / red  blau / blue  grün / green		Montageverpackung OEM          UVP 15,90 €
<b>NEW</b> 25	20 x 2.00	50-406	• TCC: 1.596 mm schwarz/weiß / black/white		Montageverpackung OEM    UVP 11,90 €



### K-831A

529127 25	26 x 1.75	47-559	• TCC: 2.042 mm		Montageverpackung OEM   UVP 11,90 €
520525 25	26 x 1.95	50-559	• TCC: 2.077 mm		Montageverpackung OEM   UVP 11,90 €
<b>NEW</b> 25	26 x 2.10	54-559	• TCC: 2.121 mm		Montageverpackung OEM   UVP 12,90 €



### K-898

529695 25	26 x 1.95	50-559	• Reflex • TCC: 2.070 mm		Montageverpackung OEM   UVP 16,90 €
520520 25			• TCC: 2.077 mm		Montageverpackung OEM   UVP 13,90 €
<b>NEW</b> 25	26 x 2.10	54-559	• TCC: 2.095 mm		Montageverpackung OEM   UVP 14,90 €

ART.-NR. 	GRÖSSE SIZE	ETRTO NR. ETRTO NO.	SPEZIFIKATIONEN SPECIFICATIONS	VERPACKUNG PACKAGING
---	----------------	------------------------	-----------------------------------	-------------------------



›**KWICK**‹  
K-879

520523 25	26x1.95	50-559	• TCC: 2.064 mm	Montageverpackung OEM  UVP 14,90 €
--------------	---------	--------	-----------------	---



K-948

529266 25	26x1.95	50-559	• TCC: 2.061 mm	Montageverpackung OEM  UVP 14,90 €
--------------	---------	--------	-----------------	---



›**KROSS PLUS**‹  
K-847

520521 25	26x1.95	50-559	• TCC: 2.048 mm	Montageverpackung OEM  UVP 14,90 €
--------------	---------	--------	-----------------	---



K-90

520528 25	26x1.95	50-559	• TCC: 2.073 mm	Montageverpackung OEM  UVP 14,90 €
--------------	---------	--------	-----------------	---











ART.-NR. 	GRÖSSE SIZE	ETRTO NR. ETRTO NO.	SPEZIFIKATIONEN SPECIFICATIONS	VERPACKUNG PACKAGING
--	----------------	------------------------	-----------------------------------	-------------------------













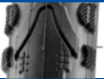
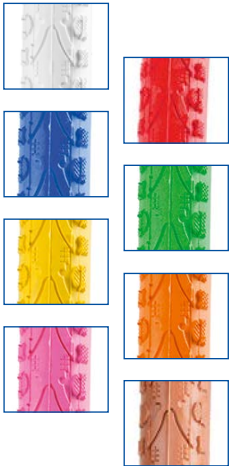



TREKKING / CITY

TREKKING / CITY

















### »KHAN« K-935

<b>527774</b> 10 ★	<b>700 x 35 C</b>	37-622	<ul style="list-style-type: none"> <li>• 60 TPI</li> <li>• K-Shield Plus</li> <li>• E-Bike zertifiziert bis 50 km/h (ECE-R75)</li> <li>• e-bike certified up to 50 km/h (ECE-R75)</li> <li>• Reflex</li> <li>• TCC: 2.199 mm</li> </ul>	   <b>3x NOTE 1</b> BESTER PANNENSCHUTZ SEINER KLASSE!	Banderole tag  UVP 32,90 €
<b>520535</b> 25			<ul style="list-style-type: none"> <li>• K-Shield</li> <li>• E-Bike geeignet / approved</li> <li>• Reflex</li> <li>• TCC: 2.199 mm</li> </ul>	 	mit Karte with tag  UVP 16,90 €
<b>529651</b> 25 NEW			<ul style="list-style-type: none"> <li>• 30 TPI</li> <li>• K-Shield</li> <li>• E-Bike geeignet / approved</li> <li>• TCC: 2.199 mm</li> </ul>	 	mit Karte with tag  UVP 15,90 €
<b>520534</b> 25			<ul style="list-style-type: none"> <li>• Reflex</li> <li>• TCC: 2.199 mm</li> </ul>		Montageverpackung OEM UVP 15,90 €
<b>520530</b> 25			<ul style="list-style-type: none"> <li>• TCC: 2.199 mm</li> </ul>		Montageverpackung OEM UVP 11,90 €
<b>529389</b> 10 ★	<b>700 x 38 C</b>	40-622	<ul style="list-style-type: none"> <li>• 60 TPI</li> <li>• K-Shield Plus</li> <li>• E-Bike geeignet / approved</li> <li>• Reflex</li> <li>• TCC: 2.199 mm</li> </ul>	   <b>3x NOTE 1</b> BESTER PANNENSCHUTZ SEINER KLASSE!	Banderole tag  UVP 32,90 €
<b>527510</b> 25 NEW			<ul style="list-style-type: none"> <li>• K-Shield</li> <li>• E-Bike geeignet / approved</li> <li>• Reflex</li> <li>• TCC: 2.199 mm</li> </ul>	 	Montageverpackung OEM UVP 17,90 €
<b>529016</b> 25 NEW			<ul style="list-style-type: none"> <li>• K-Shield</li> <li>• E-Bike geeignet / approved</li> <li>• TCC: 2.199 mm</li> </ul>	 	mit Karte with tag  UVP 14,90 €

ART.-NR. 	GRÖSSE SIZE	ETRTO NR. ETRTO NO.	SPEZIFIKATIONEN SPECIFICATIONS	 KHAN K-935		VERPACKUNG PACKAGING
<b>529392</b> <b>529393</b> <b>529394</b> <b>529395</b> <b>529396</b> <b>NEW</b> <b>529397</b> <b>529398</b> <b>529399</b> 25	<b>700 x 38 C</b>	40-622	<ul style="list-style-type: none"> <li>Reflex</li> <li>TCC: 2.187 mm</li> </ul> weiß / white rot / red blau / blue grün / green gelb / yellow orange / orange pink / pink braun / brown			Montageverpackung OEM UVP 17,90 €
<b>520532</b> 25			<ul style="list-style-type: none"> <li>schwarz</li> <li>TCC: 2.187 mm</li> </ul>			Montageverpackung OEM UVP 12,90 €
<b>529331</b> 10 	<b>700 x 40 C</b>	42-622	<ul style="list-style-type: none"> <li>60 TPI</li> <li>K-Shield Plus</li> <li>E-Bike geeignet / approved</li> <li>Reflex</li> <li>TCC: 2.209 mm</li> </ul>		Banderole tag  UVP 32,90 €	
<b>529087</b> 25			<ul style="list-style-type: none"> <li>K-Shield</li> <li>E-Bike geeignet / approved</li> <li>Reflex</li> <li>TCC: 2.209 mm</li> </ul>		mit Karte with tag  UVP 18,90 €	
<b>529652</b> 25 <b>NEW</b>			<ul style="list-style-type: none"> <li>30 TPI</li> <li>K-Shield</li> <li>E-Bike geeignet / approved</li> <li>TCC: 2.209 mm</li> </ul>		mit Karte with tag  UVP 16,90 €	
<b>520533</b> 25			<ul style="list-style-type: none"> <li>Reflex</li> <li>TCC: 2.209 mm</li> </ul>			Montageverpackung OEM UVP 16,90 €
<b>520531</b> 25			<ul style="list-style-type: none"> <li>TCC: 2.209 mm</li> </ul>			Montageverpackung OEM UVP 12,90 €
<b>529654</b> 10 	<b>700 x 45 C</b> <b>28 x 1.75</b>	47-622	<ul style="list-style-type: none"> <li>60 TPI</li> <li>K-Shield Plus</li> <li>E-Bike geeignet / approved</li> <li>Reflex</li> <li>TCC: 2.249 mm</li> </ul>		Banderole tag  UVP 32,90 €	
<b>529015</b> 25			<ul style="list-style-type: none"> <li>K-Shield</li> <li>E-Bike geeignet / approved</li> <li>Reflex</li> <li>TCC: 2.249 mm</li> </ul>		mit Karte with tag  UVP 19,90 €	
<b>529511</b> 25 <b>NEW</b>			<ul style="list-style-type: none"> <li>30 TPI</li> <li>K-Shield</li> <li>E-Bike geeignet / approved</li> <li>TCC: 2.249 mm</li> </ul>		mit Karte with tag  UVP 18,90 €	
<b>529177</b> 25			<ul style="list-style-type: none"> <li>Reflex</li> <li>TCC: 2.249 mm</li> </ul>			Montageverpackung OEM UVP 16,90 €
<b>529176</b> 25			<ul style="list-style-type: none"> <li>TCC: 2.249 mm</li> </ul>			Montageverpackung OEM UVP 13,90 €



ART.-NR. 	GRÖSSE SIZE	ETRTO NR. ETRTO NO.	SPEZIFIKATIONEN SPECIFICATIONS	VERPACKUNG PACKAGING
<b>529270</b> 25	<b>650 B x 2.10</b> <b>27.5 x 2.10</b>	52-584	<ul style="list-style-type: none"> <li>• 30 TPI</li> <li>• TCC: 2.205 mm</li> </ul>	Montageverpackung OEM UVP 18,90 €
<b>529364</b> 10 ★	<b>26 x 1.75</b>	47-559	<ul style="list-style-type: none"> <li>• 60 TPI</li> <li>• K-Shield Plus</li> <li>• E-Bike geeignet / approved</li> <li>• Reflex</li> <li>• TCC: 2.023 mm</li> </ul>	  Banderole tag  UVP 33,90 €
<b>529093</b> 25			<ul style="list-style-type: none"> <li>• K-Shield</li> <li>• E-Bike geeignet / approved</li> <li>• Reflex</li> <li>• TCC: 2.023 mm</li> </ul>	  mit Karte with tag  UVP 18,90 €
<b>529095</b> 25			<ul style="list-style-type: none"> <li>• K-Shield</li> <li>• E-Bike geeignet / approved</li> <li>• TCC: 2.023 mm</li> </ul>	  mit Karte with tag  UVP 14,90 €
<b>529126</b> 25			<ul style="list-style-type: none"> <li>• Reflex</li> <li>• TCC: 2.023 mm</li> </ul>	Montageverpackung OEM UVP 15,90 €
<b>529125</b> 25			<ul style="list-style-type: none"> <li>• TCC: 2.023 mm</li> </ul>	Montageverpackung OEM UVP 12,90 €
<b>529091</b> 25	<b>26 x 1.95</b>	50-559	<ul style="list-style-type: none"> <li>• K-Shield</li> <li>• E-Bike geeignet / approved</li> <li>• Reflex</li> <li>• TCC: 2.061 mm</li> </ul>	  mit Karte with tag  UVP 18,90 €
<b>529044</b> 25			<ul style="list-style-type: none"> <li>• K-Shield</li> <li>• E-Bike geeignet / approved</li> <li>• TCC: 2.061 mm</li> </ul>	  mit Karte with tag  UVP 15,90 €
<b>529144</b> 25			<ul style="list-style-type: none"> <li>• TCC: 2.061 mm</li> </ul>	Montageverpackung OEM UVP 13,90 €
<b>520501</b> 25	<b>24 x 1.75</b>	47-507	<ul style="list-style-type: none"> <li>• TCC: 1.875 mm</li> </ul>	Montageverpackung OEM UVP 11,90 €
<b>529105</b> 25	<b>20 x 1.75</b>	47-406	<ul style="list-style-type: none"> <li>• TCC: 1.552 mm</li> </ul>	Montageverpackung OEM UVP 9,90 €
<b>520500</b> 25	<b>18 x 1.75</b>	47-355	<ul style="list-style-type: none"> <li>• TCC: 1.385 mm</li> </ul>	Montageverpackung OEM UVP 8,90 €
<b>529100</b> 25	<b>16 x 1.75</b>	47-305	<ul style="list-style-type: none"> <li>• TCC: 1.225 mm</li> </ul>	Montageverpackung OEM UVP 6,90 €
<b>520741</b> 25	<b>12 1/2 x 2 1/4</b>	62-203	<ul style="list-style-type: none"> <li>• TCC: 958 mm</li> </ul>	Montageverpackung OEM UVP 6,90 €
<b>NEW</b> <b>520742</b> <b>520743</b> <b>520744</b> <b>520745</b> <b>520746</b> <b>520748</b> 25			<ul style="list-style-type: none"> <li>• TCC: 958 mm</li> </ul> weiß / white rot / red blau / blue grün / green gelb / yellow pink / pink	      Montageverpackung OEM UVP 8,90 €

ART.-NR.  

GRÖSSE  
SIZE

ETRTO NR.  
ETRTO NO.

SPEZIFIKATIONEN  
SPECIFICATIONS







VERPACKUNG  
PACKAGING



»KHAN II«  
K-1172









529259 10 ★	700 x 35 C	35-622	<ul style="list-style-type: none"> <li>• 60 TPI</li> <li>• K-Shield Plus</li> <li>• E-Bike geeignet / approved</li> <li>• Reflex</li> <li>• TCC: 2.190 mm</li> </ul>	 	Banderole tag  UVP 28,90 €
529006 25			<ul style="list-style-type: none"> <li>• K-Shield</li> <li>• E-Bike geeignet / approved</li> <li>• Reflex</li> <li>• TCC: 2.193 mm</li> </ul>	 	mit Karte with tag  UVP 16,90 €
529005 25			TCC: 2.193 mm		Montageverpackung OEM UVP 11,90 €
529258 10 ★	700 x 40 C	42-622	<ul style="list-style-type: none"> <li>• 60 TPI</li> <li>• K-Shield Plus</li> <li>• E-Bike geeignet / approved</li> <li>• Reflex</li> <li>• TCC: 2.218 mm</li> </ul>	 	Banderole tag  UVP 32,90 €
529090 25			<ul style="list-style-type: none"> <li>• K-Shield</li> <li>• E-Bike geeignet / approved</li> <li>• Reflex</li> <li>• TCC: 2.231 mm</li> </ul>	 	mit Karte with tag  UVP 19,90 €
529009 25			<ul style="list-style-type: none"> <li>• Reflex</li> <li>• TCC: 2.218 mm</li> </ul>		Montageverpackung OEM UVP 15,90 €
529010 25			<ul style="list-style-type: none"> <li>• creme</li> <li>• 30 TPI</li> <li>• Reflex</li> <li>• TCC: 2.218 mm</li> </ul>		Montageverpackung OEM UVP 18,90 €
529257 10 ★	700 x 45 C 28 x 1.75	45-622	<ul style="list-style-type: none"> <li>• 60 TPI</li> <li>• K-Shield Plus</li> <li>• E-Bike geeignet / approved</li> <li>• Reflex</li> <li>• TCC: 2.253 mm</li> </ul>	 	Banderole tag  UVP 32,90 €
529012 25			<ul style="list-style-type: none"> <li>• K-Shield</li> <li>• E-Bike geeignet / approved</li> <li>• Reflex</li> <li>• TCC: 2.253 mm</li> </ul>	 	mit Karte with tag  UVP 19,90 €
529008 25			TCC: 2.271 mm		Montageverpackung OEM UVP 13,90 €
529011 25 ★	700 x 50 C	50-622	<ul style="list-style-type: none"> <li>• 30 TPI</li> <li>• K-Shield</li> <li>• E-Bike geeignet / approved</li> <li>• Reflex</li> <li>• nur / only 1.092 g</li> <li>• TCC: 2.297 mm</li> </ul>	FAT KHAN  	mit Karte with tag  UVP 26,90 €

ART.-NR. 	GRÖSSE SIZE	ETRTO NR. ETRTO NO.	SPEZIFIKATIONEN SPECIFICATIONS		VERPACKUNG PACKAGING
<b>520903</b> 25 ★	<b>650 B x 2.10</b> <b>27.5 x 2.10</b>	53-584	<ul style="list-style-type: none"> <li>• 30 TPI</li> <li>• K-Shield</li> <li>• E-Bike geeignet / approved</li> <li>• Reflex</li> <li>• nur / only 1.038 g</li> <li>• TCC: 2.177 mm</li> </ul>	<b>FAT KHAN</b>  	mit Karte with tag  UVP 28,90 €
<b>529007</b> 25	<b>26 x 1.95</b>	50-559	<ul style="list-style-type: none"> <li>• K-Shield</li> <li>• E-Bike geeignet / approved</li> <li>• TCC: 2.095 mm</li> </ul>	 	mit Karte with tag  UVP 17,90 €
<b>529092</b> 25	<b>26 x 1.75</b>	47-559	TCC: 2.042 mm		Montageverpackung OEM UVP 11,90 €
<b>529004</b> 25	<b>24 x 1.75</b>	44-507	TCC: 1.869 mm		Montageverpackung OEM UVP 11,90 €
<b>529003</b> 25	<b>20 x 1.75</b>	44-406	TCC: 1.558 mm		Montageverpackung OEM UVP 8,90 €





## ›EUROTREK‹ K-197

<b>529018</b> 25 ★	<b>700 x 38 C</b>	40-622	<ul style="list-style-type: none"> <li>• 30 TPI</li> <li>• K-Shield</li> <li>• E-Bike geeignet / approved</li> <li>• TCC: 2.202 mm</li> </ul>	 	mit Karte with tag  UVP 17,90 €
<b>527773</b> 25 <b>NEW</b>			<ul style="list-style-type: none"> <li>• K-Shield</li> <li>• E-Bike geeignet / approved</li> <li>• TCC: 2.215 mm</li> </ul>	 	mit Karte with tag  UVP 16,90 €
<b>529165</b> 25			<ul style="list-style-type: none"> <li>• Reflex</li> <li>• TCC: 2.202mm</li> </ul>		Montageverpackung OEM UVP 16,90 €



## ›KWICK JOURNEY‹ K-1129

<b>527988</b> 25 ★★★	<b>700 x 40 C</b>	40-622	<ul style="list-style-type: none"> <li>• 60 TPI</li> <li>• K-Shield</li> <li>• E-Bike zertifiziert bis 50 km/h (ECE-R75) e-bike certified up to 50 km/h (ECE-R75)</li> <li>• Reflex</li> <li>• TCC: 2.227 mm</li> </ul>	 	Banderole tag  UVP 40,90 €
----------------------------	-------------------	--------	---	---	--

ART.-NR. 	GRÖSSE SIZE	ETRTO NR. ETRTO NO.	SPEZIFIKATIONEN SPECIFICATIONS	VERPACKUNG PACKAGING
---	----------------	------------------------	-----------------------------------	-------------------------



›**KOAST**‹  
K-1082

<b>523958</b> 25 ★	<b>650 B x 1.75</b> <b>27.5 x 1.75</b>	45-584	<ul style="list-style-type: none"> <li>• 30 TPI</li> <li>• TCC: 2.158 mm</li> </ul>	Montageverpackung OEM  UVP 17,90 €
--------------------------	---	--------	---	---





›**KWEST**‹  
K-193

<b>520546</b> 25	<b>650 B x 1.35</b> <b>27.5 x 1.35</b>	34-584	<ul style="list-style-type: none"> <li>• 30 TPI</li> <li>• TCC: 2.004 mm</li> </ul>	Montageverpackung OEM  UVP 15,90 €
<b>520566</b> 25 ★	<b>26 x 1.50</b>	40-559	<ul style="list-style-type: none"> <li>• 30 TPI</li> <li>• nur 553 g only 553 g</li> <li>• TCC: 2.073 mm</li> </ul>	Montageverpackung OEM  UVP 14,90 €



›**KWICK ROLLER SPORT**‹  
K-1029

<b>521824</b> 25 ★	<b>26 x 1.25</b>	32-559	<ul style="list-style-type: none"> <li>• 60 TPI</li> <li>• L3R</li> <li>• TCC: 1.989 mm</li> </ul>		Banderole tag   UVP 19,90 €
--------------------------	------------------	--------	--	---	--



ART.-NR. 	GRÖSSE SIZE	ETRTO NR. ETRTO NO.	SPEZIFIKATIONEN SPECIFICATIONS	VERPACKUNG PACKAGING
--	----------------	------------------------	-----------------------------------	-------------------------



### ›KOURIER‹ K-192

<b>529055</b> 25	<b>26 x 1 3/8</b>	37-590	<ul style="list-style-type: none"> <li>nur / only 586 g</li> <li>TCC: 2.083 mm</li> </ul>	Montageverpackung OEM UVP 11,90 €
<b>529053</b> 25	<b>24 x 1 3/8</b>	37-540	<ul style="list-style-type: none"> <li>nur / only 539 g</li> <li>TCC: 1.932 mm</li> </ul>	Montageverpackung OEM UVP 11,90 €



### K-127

<b>527613</b> <b>NEW</b> 25	<b>26 x 1.75 x 2.00</b>	47-559	<ul style="list-style-type: none"> <li>weißwand / whitewall</li> <li>TCC: 2.029 mm</li> </ul>	Montageverpackung OEM UVP 14,90 €
--------------------------------	-------------------------	--------	---	--------------------------------------



### K-184

<b>524717</b> <b>NEW</b> 25	<b>26 x 1 3/8</b>	37-590	<ul style="list-style-type: none"> <li>weißwand / whitewall</li> <li>TCC: 2.058 mm</li> </ul>	Montageverpackung OEM UVP 12,90 €
<b>525801</b> <b>NEW</b> 25	<b>26 x 1.50 x 1 3/8</b>	37-584	<ul style="list-style-type: none"> <li>weißwand / whitewall</li> <li>TCC: 2.108 mm</li> </ul>	Montageverpackung OEM UVP 11,90 €



### K-133

<b>524705</b> <b>NEW</b> 25	<b>26 x 1 3/8</b>	37-590	<ul style="list-style-type: none"> <li>weißwand / whitewall</li> <li>TCC: 2.089 mm</li> </ul>	Montageverpackung OEM UVP 12,90 €
--------------------------------	-------------------	--------	---	--------------------------------------

ART.-NR. 	GRÖSSE SIZE	ETRTO NR. ETRTO NO.	SPEZIFIKATIONEN SPECIFICATIONS	VERPACKUNG PACKAGING
---	----------------	------------------------	-----------------------------------	-------------------------



**K-103**













<b>520574</b> <b>NEW</b> 25	<b>27 x 1 1/4</b>	32-630	TCC: 2.187 mm	Montageverpackung OEM UVP 9,90 €
--------------------------------	-------------------	--------	---------------	--

**CARGO**

**CARGO**



**›KWICK DRUMLIN CARGO‹  
K-1216**

<b>529302</b> 25 ★ <b>NEW</b>	<b>26 x 2.00</b>	50-559	<ul style="list-style-type: none"> <li>• 60 TPI</li> <li>• extrem belastbar: bis 150 kg/Reifen extremely loadable: up to 150 kg/tire</li> <li>• K-Shield</li> <li>• E-Bike geeignet / approved</li> <li>• Single Tread Compound</li> <li>• TCC: 2.111 mm</li> </ul>	<b>SINGLE TREAD</b>  	Banderole tag  UVP 59,90 €
<b>529477</b> 10 ★ <b>NEW</b>	<b>26 x 2.40</b>	61-559	<ul style="list-style-type: none"> <li>• 60 TPI</li> <li>• extrem belastbar: bis 150 kg/Reifen extremely loadable: up to 150 kg/tire</li> <li>• K-Shield</li> <li>• E-Bike geeignet / approved</li> <li>• Single Tread Compound</li> <li>• TCC: 2.111 mm</li> </ul>	<b>SINGLE TREAD</b>  	Montageverpackung OEM UVP 59,90 €
<b>529301</b> 25 ★ <b>NEW</b>	<b>24 x 2.00</b>	50-507	<ul style="list-style-type: none"> <li>• 60 TPI</li> <li>• extrem belastbar: bis 150 kg/Reifen extremely loadable: up to 150 kg/tire</li> <li>• K-Shield</li> <li>• E-Bike geeignet / approved</li> <li>• Single Tread Compound</li> <li>• TCC: 1.945 mm</li> </ul>	<b>SINGLE TREAD</b>  	Banderole tag  UVP 59,90 €
<b>529475</b> 10 ★ <b>NEW</b>	<b>20 x 2.40</b>	61-406	<ul style="list-style-type: none"> <li>• 60 TPI</li> <li>• extrem belastbar: bis 150 kg/Reifen extremely loadable: up to 150 kg/tire</li> <li>• K-Shield</li> <li>• E-Bike geeignet / approved</li> <li>• Single Tread Compound</li> <li>• TCC: 1.678 mm</li> </ul>	<b>SINGLE TREAD</b>  	Montageverpackung OEM UVP 59,90 €
<b>529300</b> 25 ★ <b>NEW</b>	<b>20 x 2.00</b>	50-406	<ul style="list-style-type: none"> <li>• 60 TPI</li> <li>• extrem belastbar: bis 150 kg/Reifen extremely loadable: up to 150 kg/tire</li> <li>• K-Shield</li> <li>• E-Bike geeignet / approved</li> <li>• Single Tread Compound</li> <li>• TCC: 1.627 mm</li> </ul>	<b>SINGLE TREAD</b>  	Banderole tag  UVP 59,90 €



ART.-NR. 	GRÖSSE SIZE	ETRTO NR. ETRTO NO.	SPEZIFIKATIONEN SPECIFICATIONS	VERPACKUNG PACKAGING
--	----------------	------------------------	-----------------------------------	-------------------------

**SPIKES** **STUDS**

SPIKES  
STUDS



### ›KLONDIKE‹ K-1014

<b>528112</b> 10 ★	<b>700 x 35C</b>	37-622	<ul style="list-style-type: none"> <li>• 30 TPI</li> <li>• mit 100 Spikes with 100 studs</li> <li>• TCC: 2.212 mm</li> </ul>	Banderole tag  UVP 59,90 €
<b>528113</b> 10 ★	<b>700 x 40 C</b>	42-622	<ul style="list-style-type: none"> <li>• 30 TPI</li> <li>• mit 100 Spikes with 100 studs</li> <li>• nur / only 802 g</li> <li>• TCC: 2.231 mm</li> </ul>	Banderole tag  UVP 59,90 €

**BMX / DIRT / KID** **BMX/DIRT/KID**



### ›FLAME‹ K-1008A



<b>523738</b> 10 ★	<b>26 x 3.00</b>	68-559	<ul style="list-style-type: none"> <li>• 60 TPI</li> <li>• TCC: 2.215 mm</li> </ul>	Banderole tag  UVP 42,90 €
--------------------------	------------------	--------	---	---



### ›FLAME‹ K-1008

<b>520669</b> 25	<b>26 x 2.125</b>	57-559	<ul style="list-style-type: none"> <li>• schwarz, Billboard-Logo black, billboard logo</li> <li>• TCC: 2.130 mm</li> </ul>	Banderole tag  UVP 27,90 €
---------------------	-------------------	--------	--	---

ART.-NR. 	GRÖSSE SIZE	ETRTO NR. ETRTO NO.	SPEZIFIKATIONEN SPECIFICATIONS	VERPACKUNG PACKAGING	
 <div style="float: right; text-align: right;"> <h2>›BOOSTER PRO‹</h2> <h3>K-1227</h3> <p><b>BEST CONTROL DIRT JUMP</b></p> </div>					
Speed  Grip  Protection  Durability 				LUCAS HUPPERT  RUSO BROS 	
<b>523526</b> 20 	<b>26 x 2.25</b>	57-559	<ul style="list-style-type: none"> <li>• 120 TPI</li> <li>• Kevlar faltbar / folded</li> <li>• Tubeless Race</li> <li>• Single Tread Compound</li> <li>• nur / only 531 g</li> <li>• TCC: 2.143 mm</li> </ul>	<b>SINGLE TREAD</b> 	Eurolochkarte eurohole card  UVP 64,90 €
 <div style="float: right; text-align: right;"> <h2>›3-SIXTY PRO‹</h2> <h3>K-1238</h3> <p><b>BEST CONTROL STREET</b></p> </div>					
				LUCAS HUPPERT  RUSO BROS 	
<b>523524</b> 20 	<b>26 x 2.25</b>	57-559	<ul style="list-style-type: none"> <li>• 120 TPI</li> <li>• Kevlar faltbar / folded</li> <li>• Tubeless Race</li> <li>• Single Tread Compound</li> <li>• beige/schwarz / cream/black</li> <li>• nur / only 598 g</li> <li>• TCC: 2.143 mm</li> </ul>	<b>SINGLE TREAD</b> 	Eurolochkarte eurohole card  UVP 65,90 €
 <div style="float: right; text-align: right;"> <h2>›K-RAD‹</h2> <h3>K-905</h3> </div>					
				TOM OEHLER 	
<b>529506</b> 25 	<b>26 x 2.30</b>	58-559	<ul style="list-style-type: none"> <li>• 60 TPI</li> <li>• PRC</li> <li>• TCC: 2.124 mm</li> </ul>	<b>PRC</b> Pannenschutz Puncture Protection	Banderole tag  UVP 31,90 €
<b>523426</b> 25 	<b>24 x 2.30</b>	58-507	<ul style="list-style-type: none"> <li>• 60 TPI</li> <li>• PRC</li> <li>• TCC: 1.951 mm</li> </ul>	<b>PRC</b> Pannenschutz Puncture Protection	Banderole tag  UVP 28,90 €
<b>529102</b> 25 	<b>20 x 2.35</b>	58-406	<ul style="list-style-type: none"> <li>• 30 TPI</li> <li>• TCC: 1.640 mm</li> </ul>		Banderole tag  UVP 13,90 €



ART.-NR. 	GRÖSSE SIZE	ETRTO NR. ETRTO NO.	SPEZIFIKATIONEN SPECIFICATIONS	VERPACKUNG PACKAGING
--	----------------	------------------------	-----------------------------------	-------------------------



### ›KINIPTION‹ K-1016



<b>520733</b> 25 ★	<b>26 x 2.30</b>	58-559	<ul style="list-style-type: none"> <li>• 60 TPI</li> <li>• TCC: 1.960 mm</li> </ul>	Banderole tag  UVP 25,90 €
--------------------------	------------------	--------	---	---



<b>527027</b> 25 ★	<b>20 x 2.10</b>	54-406	<ul style="list-style-type: none"> <li>• 30 TPI</li> <li>• TCC: 1.602 mm</li> </ul>	Banderole tag  UVP 13,90 €
--------------------------	------------------	--------	---	---

- Speed 
- Grip 
- Protection 
- Durability 



### ›SLANT SIX SPORT‹ K-1080

<b>520919</b> 25 ★★	<b>24 x 2.60</b>	66-507	<ul style="list-style-type: none"> <li>• 60 TPI</li> <li>• L3R-Pro</li> <li>• nur / only 720 g</li> <li>• TCC: 2.029 mm</li> </ul>	 Banderole tag  UVP 36,90 €
---------------------------	------------------	--------	--	---

<b>520918</b> 25 ★★	<b>20 x 2.60</b>	66-406	<ul style="list-style-type: none"> <li>• 60 TPI</li> <li>• L3R-Pro</li> <li>• nur / only 575 g</li> <li>• TCC: 1.712 mm</li> </ul>	 Banderole tag  UVP 29,90 €
---------------------------	------------------	--------	--	---



### ›AMRAK‹ K-1247

<b>529336</b> 25 ★	<b>24 x 2.20</b>	56-507	<ul style="list-style-type: none"> <li>• 30 TPI</li> <li>• nur / only 661 g</li> <li>• TCC: 2.001 mm</li> </ul>	Montageverpackung OEM UVP 19,90 €
--------------------------	------------------	--------	---	---

<b>529335</b> 25 ★	<b>20 x 2.20</b>	56-406	<ul style="list-style-type: none"> <li>• 30 TPI</li> <li>• nur / only 551 g</li> <li>• TCC: 1.649 mm</li> </ul>	Montageverpackung OEM UVP 15,90 €
--------------------------	------------------	--------	---	---





ART.-NR. 	GRÖSSE SIZE	ETRTO NR. ETRTO NO.	SPEZIFIKATIONEN SPECIFICATIONS	VERPACKUNG PACKAGING
			 <h2 data-bbox="715 365 911 488">»FISH« K-921</h2>	
<b>526210</b> 25	<b>12 1/2 x 2 1/4</b>	62-203	<ul style="list-style-type: none"> <li>• TCC: 958 mm</li> </ul>	Montageverpackung OEM  UVP 6,90 €
			 <h2 data-bbox="810 846 991 904">K-850</h2>	
<b>529249</b> 25	<b>12 1/2 x 2 1/4</b>	62-203	<ul style="list-style-type: none"> <li>• TCC: 598 mm</li> </ul>	Montageverpackung OEM  UVP 6,90 €
			 <h2 data-bbox="810 1339 1038 1397">K-909A</h2>	
<b>525003</b> 25	<b>10x2.00</b>	54-152	<ul style="list-style-type: none"> <li>• TCC: 798 mm</li> </ul>	Montageverpackung OEM  UVP 6,90 €
<b>529184</b> 25	<b>121/2x1.75x21/4</b>	47-203	<ul style="list-style-type: none"> <li>• TCC: 949 mm</li> </ul>	Montageverpackung OEM  UVP 7,90 €
<p><b>INFO</b></p>			<p>Auf Wunsch bieten wir eine Auszeichnung mit <b>Kenda Banderole</b> (Art. 084232) an: GTIN + Modell-Nr. + Größe + Preis + ...</p> <p>On request we'll offer a labelling with <b>Kenda tag</b> (art. 084232): GTIN + model no. + size + price + ...</p>	 





# KUJO

## *Rollin´ it right*

Reifen - Schläuche - kein Schickimicki. Darum geht es bei KUJO. KUJO bietet top Funktion und sorgenfreies Fahren zu einem unschlagbaren Preis.

Egal ob MTB, Trekking, Rennrad oder BMX - wir haben immer den richtigen Reifen.

Dank unserer langjährigen Erfahrung in Entwicklung und Vertrieb von Fahrradreifen, sind alle Produkte genau an die Bedürfnisse des Marktes angepasst.

KUJO Reifen zeichnen sich aus durch Performance, Qualität und große Zuverlässigkeit, zu einem attraktiven Preis.

Tires - tubes - no chichi. That's what KUJO is all about. KUJO gives you maximum function and carefree driving at an unbeatable price.

No matter if MTB, trekking, road racing or BMX - we have always the right tire. Thanks to our longstanding experience in R&D and distribution of bicycle tires, all products are adjusted to the needs of the market.

KUJO tires stand out for their performance, quality and great reliability, at an attractive price.

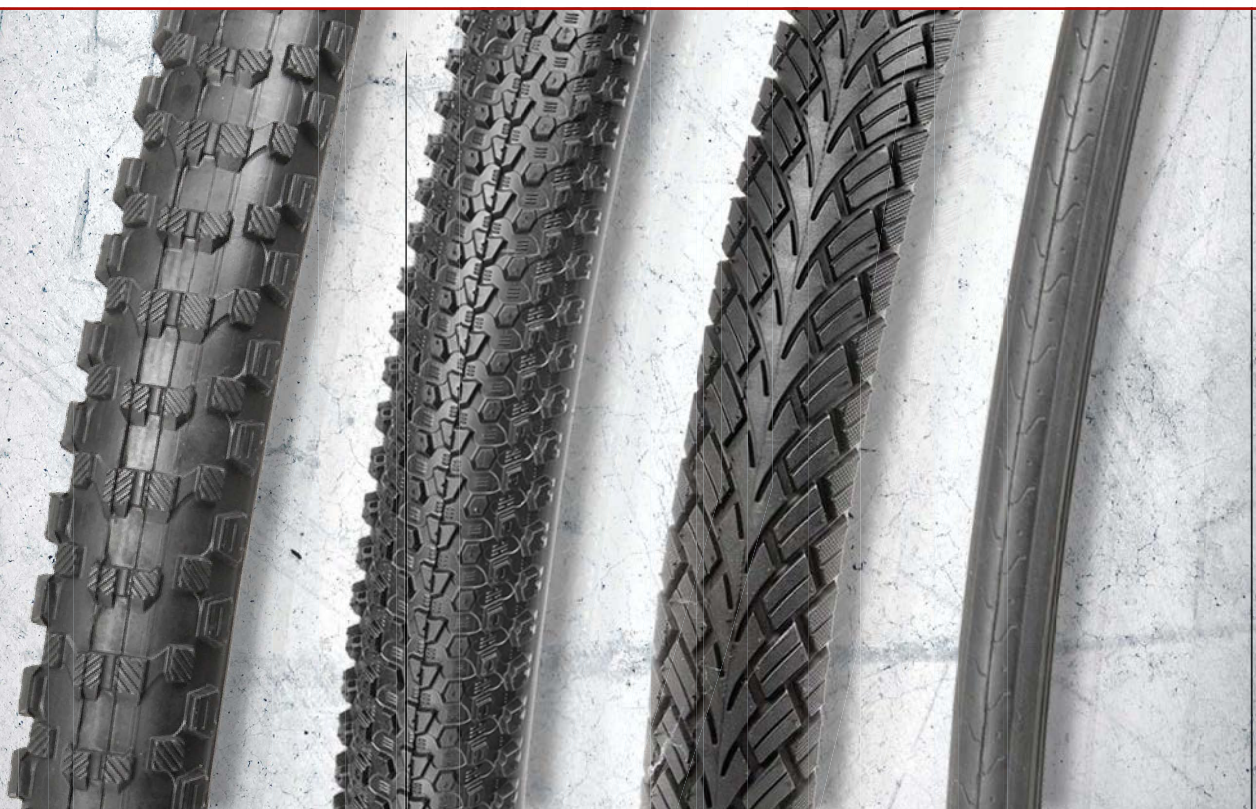

GRÖSSE SIZE	ETRTO NR. ETRTO NO.	VENTIL VALVE	ART.-NR. ART.-NO.	BESONDERHEIT SPECIALTY
<b>DV</b> 				
<b>DUNLOP-EXPRESS</b> 28/35/40 mm				
<b>FV</b> 				
<b>SCLAVERAND/FRENCH/PRESTA</b> 32/48/60/80 mm				
<b>AV</b> 				
<b>AUTO/SCHRADER/AMERICAN</b> 35/40/48 mm				
<b>AV</b> 45°/70° 				
<b>AUTO/SCHRADER/AMERICAN</b>				

### UNIVERSALSCHLÄUCHE

- hochelastische Butyl-Mischung für exzellente Luftdichtigkeit
- frost- und hitzebeständig
- in Kujo Eurolochbox, 50 Stück im Exportkarton

### UNIVERSAL TUBES

- highly elastic Butyl mixture for excellent air retention performance
- anti-freezing and heat resisting
- in Kujo eurohole box, 50 pcs. in export carton



8"	8 1/2 x 2.0	48/52-134	22 mm	<b>553058</b>	threaded		UVP 4,90 €
12"	12 1/2 x 1.75 - 2 1/4	47/62-203	33 mm	<b>553020</b>			
			45°	<b>553021</b>	Montageverp. / OEM	<b>AV 45°/70° abgewinkelt / bent</b>	UVP 4,90 €
14"	14 x 1.75 - 2.125	47/57-254/263	33 mm	<b>553048</b>			UVP 4,90 €
16"	16 x 1.75 - 2.125	47/57-305	33 mm	<b>553022</b>			
				<b>553181</b>	Montageverp. / OEM		UVP 4,90 €
18"	18 x 1.75 - 2.125	47/57-355	33 mm	<b>553038</b>			UVP 4,90 €
20"	20 x 1.75 - 2.125	47/57-406	33 mm	<b>553023</b>			
			33 mm	<b>553182</b>	Montageverp. / OEM		
			48 mm	<b>559127</b>	Montageverp. / OEM		UVP 4,90 €
24"	24 x 1.75 - 2.125	47/57-507	33 mm	<b>553024</b>			
			33 mm	<b>553183</b>	Montageverp. / OEM		
			48 mm	<b>559126</b>	Montageverp. / OEM		UVP 4,90 €

	GRÖSSE SIZE	ETRTO NR. ETRTO NO.	VENTIL VALVE	ART.-NR. ART.-NO.	BESONDERHEIT SPECIALTY	
26"	26 x 1.5 - 1.75	40/47-559	 48 mm	<b>559120</b>	Montageverp./OEM	UVP 4,90 €
	26 x 1.75 - 2.125	47/57-559	 33 mm	<b>553025</b>	Montageverp./OEM	
			 33 mm	<b>553184</b>		
			 48 mm	<b>553037</b>		
			 48 mm	<b>559129</b>	Montageverp./OEM	UVP 4,90 €
	26 x 3.8 - 4.2	96/106-559	 33 mm	<b>553046</b> 30		UVP 9,90 €
27.5"	27.5/650 B x 1.75-2.125	47/57 - 584	 48 mm	<b>559122</b>	Montageverp./OEM	UVP 4,90 €
	27.5/650 B x 1.9 - 2.4	50/63 - 584	 48 mm	<b>559132</b>	Montageverp./OEM	UVP 4,90 €
	27.5/650 B x 2.0 - 2.35	52/58 - 584	 48 mm	<b>553029</b>		UVP 4,90 €
	27.5/650 B x 2.8 - 3.2	72/80 - 584	 48 mm	<b>553047</b> 30		UVP 8,90 €
28"	700 x 18 - 25 C	18/25-622/630	 48 mm	<b>553041</b>		UVP 4,90 €
	700 x 28 - 45 C	28/47-622/630/635	 33 mm	<b>553032</b>	Montageverp./OEM	
			 33 mm	<b>553185</b>		
			 48 mm	<b>553039</b>		
			 40 mm	<b>553040</b>		
700 x 30 - 45 C	30/45-622	 48 mm	<b>559123</b>	Montageverp./OEM	UVP 4,90 €	
700 x 45 - 50 C 28 x 1.75 - 1.95	45/50-622	 48 mm	<b>559125</b>	Montageverp./OEM	UVP 4,90 €	
29" 28"	28/29 x 1.9 - 2.35	50/58-622	 48 mm	<b>553042</b>		UVP 4,90 €
	29 x 1.9 - 2.4	50/63-622	 48 mm	<b>559121</b>		UVP 5,90 €
 48 mm			<b>559133</b>	Montageverp./OEM	UVP 4,90 €	



ART.-NR. 	GRÖSSE SIZE	ETRTO NR. ETRTO NO.	SPEZIFIKATIONEN SPECIFICATIONS	VERPACKUNG PACKAGING
---	----------------	------------------------	-----------------------------------	-------------------------



## ›MR. ROBSEN‹ KU-1005

<b>558068</b> 25	<b>29 x 2.10</b>	54-622		Montageverpackung OEM UVP 17,90 €
<b>NEW</b> <b>558195</b> 10	<b>29 x 2.40</b>	60-622	<ul style="list-style-type: none"> <li>• 60 TPI</li> <li>• Kevlar faltbar / foldable</li> </ul>	Eurolochkarte eurohole card  UVP 39,90 €
<b>NEW</b> <b>558194</b> 10			• 60 TPI	Montageverpackung OEM UVP 34,90 €
<b>NEW</b> <b>558193</b> 10				Montageverpackung OEM UVP 23,90 €
<b>558067</b> 25	<b>650 B x 2.10</b> <b>27.5 x 2.10</b>	54-584		Montageverpackung OEM UVP 17,90 €
<b>558066</b> 25	<b>26 x 2.10</b>	54-559		Montageverpackung OEM UVP 16,90 €



## ›MR. RAMAPO‹ KU-1007

<b>558073</b> 25	<b>26 x 1.95</b>	53-559		Montageverpackung OEM UVP 13,90 €
<b>558070</b> 25	<b>24 x 1.95</b>	53-507		Montageverpackung OEM UVP 13,90 €
<b>558071</b> 25	<b>24 x 2.10</b>	54-507		Montageverpackung OEM UVP 13,90 €



ART.-NR. 	GRÖSSE SIZE	ETRTO NR. ETRTO NO.	SPEZIFIKATIONEN SPECIFICATIONS	VERPACKUNG PACKAGING
--	----------------	------------------------	-----------------------------------	-------------------------



## ›ATTACK‹ KU-1001

<b>558063</b> 25	<b>29 x 2.10</b>	54-622		Montageverpackung OEM UVP 17,90 €
<b>558062</b> 25	<b>650 B x 2.10</b> <b>27.5 x 2.10</b>	52-584		Montageverpackung OEM UVP 16,90 €
<b>558061</b> 25	<b>26 x 2.10</b>	52-559		Montageverpackung OEM UVP 14,90 €
<b>558060</b> 25	<b>24 x 2.10</b>	52-507		Montageverpackung OEM UVP 13,90 €



## ›HAMOVACK‹ KU-1003

<b>558065</b> 25	<b>26 x 1.95</b>	53-559		Montageverpackung OEM UVP 12,90 €
<b>558064</b> 25	<b>24 x 1.95</b>	53-507		Montageverpackung OEM UVP 13,90 €



## ›BIG MAMA‹ KU-1501

<b>558129</b> 10	<b>29 x 3.00</b>	76-622	60 TPI	Montageverpackung OEM UVP 39,90 €
<b>558127</b> 10	<b>650 B x 3.00</b> <b>27.5 x 3.00</b>	76-584	60 TPI	Montageverpackung OEM UVP 35,90 €
<b>558126</b> 10	<b>26 x 4.00</b>	100-559	60 TPI	Montageverpackung OEM UVP 48,90 €

ART.-NR. 	GRÖSSE SIZE	ETRTO NR. ETRTO NO.	SPEZIFIKATIONEN SPECIFICATIONS	VERPACKUNG PACKAGING
---	----------------	------------------------	-----------------------------------	-------------------------



## ›BULLDOZER‹ KU-1019

<b>558079</b> 25	<b>26 x 1.75</b>	47-559		Montageverpackung OEM UVP 11,90 €
---------------------	------------------	--------	--	---



## ›TRIBAL‹ KU-1021

<b>558077</b> 25	<b>650 B x 2.00</b> <b>27.5 x 2.00</b>	50-584		Montageverpackung OEM UVP 16,90 €
---------------------	---	--------	--	---



## ›KEN B‹ KU-1011

<b>558080</b> 25	<b>26 x 2.30</b>	58-559		Montageverpackung OEM UVP 17,90 €
---------------------	------------------	--------	--	---



## ›ONE O ONE T‹ KU-2003

<b>558052</b> 25	<b>700 x 45 C</b>	47-622	<ul style="list-style-type: none"> <li>mit Reflexstreifen und Pannenschutz with reflective stripes and puncture protection</li> </ul>	<b>PROTECT</b> Montageverpackung OEM UVP 18,90 €
<b>558051</b> 25				Montageverpackung OEM UVP 12,90 €

ART.-NR. 	GRÖSSE SIZE	ETRTO NR. ETRTO NO.	SPEZIFIKATIONEN SPECIFICATIONS	VERPACKUNG PACKAGING
--	----------------	------------------------	-----------------------------------	-------------------------



# ›ONE 0 ONE A‹

## KU-2005

›ONE 0 ONE A PROTECT SL‹			›ONE 0 ONE A PROTECT SL‹	
<b>558162</b> <b>NEW</b> 10	<b>700 x 55 C</b>	55-622	<ul style="list-style-type: none"> <li>• 60 TPI</li> <li>• mit Reflexstreifen und Pannenschutzeinlage aus Nylongewebe unter der Lauffläche, 37 % leichter als Art. 558161 with reflective stripes and puncture protection layer made of nylon fabric under the tread, 37 % lighter than art. 558161</li> </ul>	Montageverpackung OEM  UVP 44,90 €
›ONE 0 ONE A PROTECT‹			›ONE 0 ONE A PROTECT‹	
<b>558143</b> 25	<b>700 x 35 C</b>	37-622	<ul style="list-style-type: none"> <li>• mit Reflexstreifen und Pannenschutz with reflective stripes and puncture protection</li> </ul>	Montageverpackung OEM UVP 26,90 €
<b>558139</b> 25	<b>700 x 38 C</b>	40-622	<ul style="list-style-type: none"> <li>• mit Reflexstreifen und Pannenschutz with reflective stripes and puncture protection</li> </ul>	Montageverpackung OEM UVP 18,90 €
<b>558145</b> 25	<b>700 x 40 C</b>	42-622	<ul style="list-style-type: none"> <li>• mit Reflexstreifen und Pannenschutz with reflective stripes and puncture protection</li> </ul>	Montageverpackung OEM UVP 18,90 €
<b>558140</b> 25	<b>700 x 45 C</b>	47-622	<ul style="list-style-type: none"> <li>• mit Reflexstreifen und Pannenschutz with reflective stripes and puncture protection</li> </ul>	Montageverpackung OEM UVP 18,90 €
<b>558161</b> <b>NEW</b> 10	<b>700 x 55 C</b>	55-622	<ul style="list-style-type: none"> <li>• mit Reflexstreifen und 3 mm Pannenschutz-Einlage unter der Lauffläche with reflective stripes and 3 mm puncture protection insert under the tread</li> </ul>	Montageverpackung OEM UVP 34,90 €
<b>558138</b> 25	<b>26 x 1.75</b>	47-559	<ul style="list-style-type: none"> <li>• mit Reflexstreifen und Pannenschutz with reflective stripes and puncture protection</li> </ul>	Montageverpackung OEM UVP 16,90 €
<b>558141</b> 25	<b>26 x 1.95</b>	50-559	<ul style="list-style-type: none"> <li>• mit Reflexstreifen und Pannenschutz with reflective stripes and puncture protection</li> </ul>	Montageverpackung OEM UVP 18,90 €
›ONE 0 ONE A‹			›ONE 0 ONE A‹	
<b>558142</b> 25	<b>700 x 35 C</b>	37-622		Montageverpackung OEM UVP 9,90 €
<b>558136</b> 25	<b>700 x 38 C</b>	40-622		Montageverpackung OEM UVP 12,90 €
<b>558144</b> 25	<b>700 x 40 C</b>	42-622		Montageverpackung OEM UVP 11,90 €
<b>558137</b> 25	<b>700 x 45 C</b>	47-622		Montageverpackung OEM UVP 12,90 €
<b>558160</b> <b>NEW</b> 10	<b>700 x 55 C</b>	55-622		Montageverpackung OEM UVP 21,90 €

ART.-NR. 	GRÖSSE SIZE	ETRTO NR. ETRTO NO.	SPEZIFIKATIONEN SPECIFICATIONS	ONE 0 ONE A KU-2005	VERPACKUNG PACKAGING
558135 25	26 x 1.75	47-559			Montageverpackung OEM UVP 11,90 €
558134 25	24 x 1.75	47-507			Montageverpackung OEM UVP 11,90 €
558133 25	20 x 1.75	47-406			Montageverpackung OEM UVP 8,90 €
558132 25	16 x 1.75	47-305			Montageverpackung OEM UVP 6,90 €
558131 25	14 x 1.75	47-254			Montageverpackung OEM UVP 6,90 €
558130 25	12 1/2 x 2 1/4	62-203			Montageverpackung OEM UVP 6,90 €



## ›ONE 0 ONE‹ KU-2001

›ONE 0 ONE PROTECT‹			›ONE 0 ONE PROTECT‹		
558044 25	700 x 35 C	37-622	• mit Reflexstreifen und Pannenschutz with reflective stripes and puncture protection		Montageverpackung OEM UVP 16,90 €
558046 25	700 x 38 C	40-622	• mit Reflexstreifen und Pannenschutz with reflective stripes and puncture protection		Montageverpackung OEM UVP 17,90 €
558048 25	700 x 40 C	42-622	• mit Reflexstreifen und Pannenschutz with reflective stripes and puncture protection		Montageverpackung OEM UVP 17,90 €
558042 25	26 x 1.75	47-559	• mit Reflexstreifen und Pannenschutz with reflective stripes and puncture protection		Montageverpackung OEM UVP 16,90 €
›ONE 0 ONE‹			›ONE 0 ONE‹		
558043 25	700 x 35 C	37-622			Montageverpackung OEM UVP 9,90 €
558045 25	700 x 38 C	40-622			Montageverpackung OEM UVP 12,90 €
558047 25	700 x 40 C	42-622			Montageverpackung OEM UVP 12,90 €
558041 25	26 x 1.75	47-559			Montageverpackung OEM UVP 11,90 €
558040 25	24 x 1.75	47-507			Montageverpackung OEM UVP 11,90 €



ART.-NR. 	GRÖSSE SIZE	ETRTO NR. ETRTO NO.	SPEZIFIKATIONEN SPECIFICATIONS	VERPACKUNG PACKAGING
--------------	----------------	------------------------	-----------------------------------	-------------------------



## ›MRS. MARBLE‹ KU-4001

<b>558034</b> 25	<b>20 x 1.75</b>	47-406		Montageverpackung OEM UVP 8,90 €
<b>558035</b> 25	<b>20 x 2.125</b>	53-406		Montageverpackung OEM UVP 9,90 €



## ›TONY T‹ KU-2009

<b>558033</b> 25	<b>20 x 1.75</b>	47-406		Montageverpackung OEM UVP 8,90 €
<b>558032</b> 25	<b>18 x 1.75</b>	47-355		Montageverpackung OEM UVP 7,90 €
<b>558031</b> 25	<b>16 x 1.75</b>	47-305		Montageverpackung OEM UVP 5,90 €
<b>558030</b> 25	<b>12 1/2 x 2 1/4</b>	57-203		Montageverpackung OEM UVP 5,90 €



## ›SUZI S‹ KU-3001

<b>558056</b> 25	<b>700 x 23 C</b>	23-622	60 TPI	Montageverpackung OEM UVP 12,90 €
---------------------	-------------------	--------	--------	--------------------------------------

### INFO

Auf Wunsch bieten wir eine Auszeichnung mit **Kujo Banderole** (Art. 558098) an: GTIN + Modell-Nr. + Größe + Preis + ...

On request we'll offer a labelling with **Kujo tag** (art. 558098): GTIN + model no. + size + price + ...





# BICYCLE TRAILER

ART.-NR.

BESCHREIBUNG

DESCRIPTION

640093

1

**HARTSCHALEN-  
GEPÄCKANHÄNGER  
>STALWART CARRY BOX<**

- Zweispuranhänger mit **Hartschalen-**Gepäckbox
- Inhalt ca. 70 Liter, Box-Größe ca. 60 cm x 68 cm x 27 cm (B x L x H)
- **100 % wasserdicht**
- **abschließbar** mit Sicherheitsschloss
- bequemes und sicheres Be- und Entladen durch **hydraulisches Deckelöffnungsgestänge**
- mit **Gepäckträger auf dem Deckel**
- auch als **Handwagen, Einkaufswagen, ...** verwendbar
- **Aluminium-**Rahmen, -Naben und -Felgen
- abnehmbare **20"** Laufräder mit **Luftbereifung** und **Schnellverschluss**
- mit **Sicherheitsabweiser**
- mit **Schnellverschluss-**Universal-Kupplung (Art. 640028)
- max. Zuladung 25 kg, davon 3 kg auf dem Deckel

**HARD BOX LUGGAGE  
TRAILER  
>STALWART CARRY BOX<**

- double track luggage trailer with **hard luggage** box
- content approx. 70 ltrs, box size approx. 60 cm x 68 cm x 27 cm (W x L x H)
- **100 % waterproof**
- **lockable** by safety lock
- easy and safe (un)loading through **hydraulic lid**
- with **carrier on the lid**
- also usable as **hand cart, shopping trolley, ...**
- **aluminium** frame, hubs and rims
- detachable **20"** wheels with **air tires** and **QR**
- with **safety bumper**
- with **QR** universal hitch (art. 640028)
- max. load 25 kg, thereof 3 kg on lid



UVP 629,00 €



640005

1

**GEPÄCKANHÄNGER  
>STALWART SHOP 2<**

- **3 in 1** Anhänger: als **Fahrradanhänger**, bequemer **Einkaufstrolley** und **Sackkarre** verwendbar
- **werkzeuglos klappbare Anhängedeichsel**
- stabiler und leichter **Aluminium-**Rahmen
- mit Anhängerkupplung zur Befestigung an der Sattelstütze
- leichte **12"** Laufräder mit **Kenda Luftreifen**, Aluminiumfelgen und Edelstahl-speichen
- mit **großer** (53 x 37 x 26 cm (H x B x T), Volumen: 51 L) und **kleiner** (24 x 37 x 26 cm (H x B x T), Volumen: 23 L) **clip-on Gepäcktasche**
- Rücken aus Nylon 600D verhindert das Verschmutzen der Taschen
- ohne Tasche auch als leichte **Sackkarre** verwendbar
- max. Zuladung 21,4 kg
- Außenmaße (kompletter Anhänger, ausgeklappt) ca. 125 x 56 x 90 cm (L x B x H)

**LUGGAGE TRAILER  
>STALWART SHOP 2<**





- **3 in 1** trailer: as **bicycle trailer**, comfortable **shopping trolley** and **sacktruck** usable
- **toolless foldable trailer drawbar**
- strong and lightweight **aluminium** frame
- with trailer coupling for fastening at the seatpost
- lightweight **12"** wheels with **Kenda air tires**, aluminium rims and stainless steel spokes
- with **big** (53 x 37 x 26 cm (H x W x D), Volumen: 51 L) and **small** (24 x 37 x 26 cm (H x W x D), Volumen: 23 L) **clip-on pannier**
- back made of nylon 600D prevents the bags from getting dirty
- without pannier also usable as lightweight **sacktruck**
- max. load 21.4 kg
- measurement outside (complete trailer, unfolded) approx. 125 x 56 x 90 cm (L x W x H)

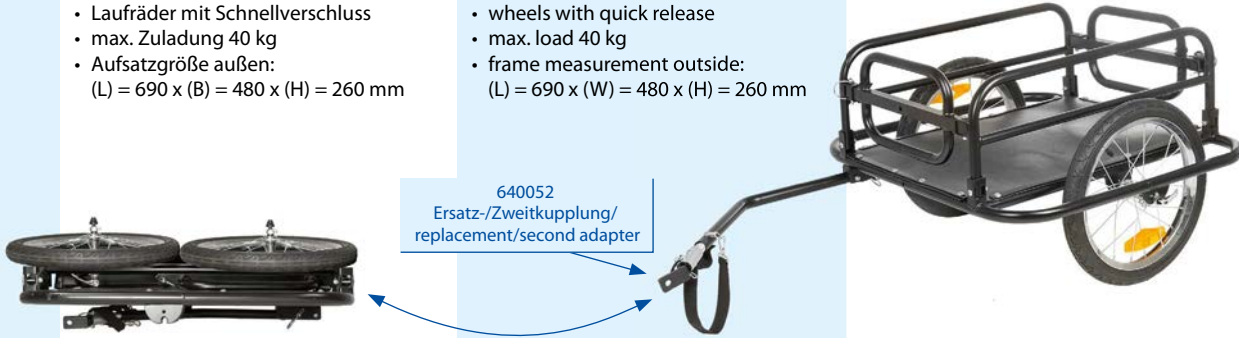

UVP 289,00 €

3 in 1



ART.-NR.	BESCHREIBUNG	DESCRIPTION	
<p><b>640060</b></p> <p>1</p>	<p><b>FALT-GEPAECKANHÄNGER</b> <b>›STALWART CARRY FOLD 2‹</b></p> <ul style="list-style-type: none"> <li>• <b>faltbarer Rahmen</b> aus Stahl</li> <li>• Laufräder mit Schnellverschluss</li> <li>• max. Zuladung 40 kg</li> <li>• Aufsatzgröße außen: (L) = 690 x (B) = 480 x (H) = 260 mm</li> </ul>	<p><b>FOLDABLE LUGGAGE TRAILER</b> <b>›STALWART CARRY FOLD 2‹</b></p> <ul style="list-style-type: none"> <li>• <b>foldable frame</b> made of steel</li> <li>• wheels with quick release</li> <li>• max. load 40 kg</li> <li>• frame measurement outside: (L) = 690 x (W) = 480 x (H) = 260 mm</li> </ul>	 <p>UVP 269,00 €</p>
<p><b>640063</b></p> <p>15 set</p>	<p><b>HANDDEICHSEL</b></p> <ul style="list-style-type: none"> <li>• für Art. 640060</li> <li>• mit weichem Schaumstoffgriff</li> <li>• Kupplung (Art. 640070/1) montierbar</li> </ul>	<p><b>HAND TOWING BAR</b></p> <ul style="list-style-type: none"> <li>• for art. 640060</li> <li>• with soft foam grip</li> <li>• hitch (art. 640070/1) mountable</li> </ul>	 <p>UVP 27,90 €</p>
<p><b>640040</b></p> <p>1</p>	<p><b>GEPAECKANHÄNGER</b> <b>›ECO TRAILER MAXI‹</b></p> <ul style="list-style-type: none"> <li>• mit Kupplung (Ersatz-/Zweitkupplung Art. 640070/1)</li> <li>• 35 kg zulässiges Gesamtgewicht als Fahrradanhänger und 70 kg als Handwagen</li> <li>• Kunststoffkasten leicht <b>abnehmbar</b></li> <li>• Kastengröße außen (L) = 58 x (B) = 39 x (H) = 30 cm</li> <li>• Inhalt <b>60 l</b></li> <li>• mit Reflektoren</li> <li>• <b>Luftreifen</b></li> <li>• Gewicht 5 kg</li> <li>• im Einzelkarton</li> </ul>	<p><b>LUGGAGE TRAILER</b> <b>›ECO TRAILER MAXI‹</b></p> <ul style="list-style-type: none"> <li>• with adapter (replacement/ second adapter art. 640070/1)</li> <li>• 35 kg gross vehicular weight as bicycle trailer and 70 kg as hand cart</li> <li>• plastic box easily <b>removable</b></li> <li>• box measurement outside (L) = 58 x (W) = 39 x (H) = 30 cm</li> <li>• content <b>60 l</b></li> <li>• with reflectors</li> <li>• <b>air tires</b></li> <li>• weight 5 kg</li> <li>• in box</li> </ul>	 <p>UVP 169,00 €</p>
	<p><b>ANHÄNGERKUPPLUNG</b></p> <ul style="list-style-type: none"> <li>• Stahl verzinkt</li> <li>• im Polybeutel mit Eurolochheader</li> </ul> <p><b>640070</b> zur Montage an der <b>Sattelklemme</b></p> <p>48 set</p> <p><b>640071</b> <b>universell</b> passend zur Montage an der <b>Sattelklemme</b> oder an der <b>Sattelstütze</b> (passend von 25,4 - 31,8 mm)</p> <p>48 set</p>	<p><b>TRAILER HITCH</b></p> <ul style="list-style-type: none"> <li>• steel zinc coated</li> <li>• in PE bag with eurohole header</li> </ul> <p>for mounting on the <b>seat clamp</b></p> <p><b>universally</b> useable for mounting on <b>seat clamp</b> or the <b>seat post</b> (suitable from 25.4 - 31.8 mm)</p>	 <p>UVP 11,90 €</p> <p>UVP 12,90 €</p>



ART.-NR.	BESCHREIBUNG	DESCRIPTION
640073 1	<b>FALT-GEPÄCKANHÄNGER</b> <b>›STALWART CARRY FOLD 1‹</b> <ul style="list-style-type: none"> <li>• <b>Aluminium-Rahmen</b>, silber, pulverbeschichtet</li> <li>• mit <b>zusätzlicher verstellbarer Handdeichsel</b> und <b>Abstellhilfe</b></li> <li>• 20" Laufräder mit Schnellverschluss und <b>Aluminiumfelgen</b></li> <li>• max. Gesamtgewicht 30 kg</li> <li>• Ablagefläche 67 x 44 x 37 cm</li> <li>• mit Reflektoren</li> <li>• mit Gepäcktasche (90 l) aus 600D Polyestergerewebe</li> </ul>	<b>FOLDABLE LUGGAGE TRAILER</b> <b>›STALWART CARRY FOLD 1‹</b> <ul style="list-style-type: none"> <li>• <b>aluminium frame</b>, silver, powder-coated frame</li> <li>• with <b>additional adjustable hand tow bar</b> and <b>parking stand</b></li> <li>• 20" quick release wheels with <b>aluminium rims</b></li> <li>• max. total weight 30 kg</li> <li>• platform size 67 x 44 x 37 cm</li> <li>• with reflectors</li> <li>• with luggage bag (90 l) made of 600D polyester</li> </ul> <p style="text-align: right;">UVP 429,00 €</p>



640047 1	<b>EINSPUR-GEPÄCKANHÄNGER</b> <b>›STALWART SINGLE 40‹</b> <ul style="list-style-type: none"> <li>• <b>Einspur</b>-Anhänger mit Lenkgelenk</li> <li>• universelles <b>Schnellspannsystem</b> zur Befestigung an der Hinterachse (wir empfehlen Adapter für 10 mm Festachse Art. 640077, Adapter für Nexus 8-Gang = 3/8" Gewinde Art. 640078), mit Sicherheitshaken (Art. 640127)</li> <li>• <b>faltbarer</b>, stabiler Stahlrahmen</li> <li>• 16" Laufrad mit <b>Aluminiumnabe</b>, mit <b>Schnellspanner</b>, <b>Aluminiumfelge</b> und <b>Kendareifen</b></li> <li>• mit Wimpel</li> <li>• max. Zuladung 27 kg</li> <li>• ebener Lochblechboden, Maße ca. 61 x 40 / 30 cm</li> <li>• Außenmaße ca. (L) = 131 x (B) = 44 x (H) = 28 cm</li> </ul>	<b>SINGLE TRACK LUGGAGE TRAILER</b> <b>›STALWART SINGLE 40‹</b> <div style="text-align: right;"> <p>7,6 kg</p> </div> <ul style="list-style-type: none"> <li>• <b>single track</b> trailer with steering joint</li> <li>• universal <b>quick release system</b> for mounting at the rear axle (we recommend an adapter for 10 mm solid axle art. 640077, adapter for Nexus 8 speed = 3/8" thread art. 640078), with safety hooks (art. 640127)</li> <li>• <b>foldable</b>, stable steel frame</li> <li>• 16" wheel with <b>aluminium</b> hub, with <b>QR</b>, <b>aluminium</b> rim and <b>Kenda</b> tire</li> <li>• with pennant</li> <li>• max. load 27 kg</li> <li>• flat perforated plate bottom, size approx. 61 x 40 / 30 cm</li> <li>• measurement outside approx. (L) = 131 x (W) = 44 x (H) = 28 cm</li> </ul> <p style="text-align: right;">UVP 195,00 €</p>
122522 15	<b>Tasche</b> für Einspur-Gepäckanhänger Art. 640047 <ul style="list-style-type: none"> <li>• <b>wasserdicht</b></li> <li>• <b>universell einsetzbar</b> auch als Reisetasche,...</li> <li>• Volumen ca. 120 Liter, ca. 60 x 38,5 x 55 cm</li> </ul>	<b>bag</b> for single track luggage trailer art. 640047 <ul style="list-style-type: none"> <li>• <b>waterproof</b></li> <li>• <b>universally applicable</b> also as a travel bag,...</li> <li>• volume approx. 120 litres, approx. 60 x 38.5 x 55 cm</li> </ul> <p style="text-align: right;">UVP 49,90 €</p>
640081 1	<b>Set</b> aus Einspur-Gepäck-Fahrradanhänger Art. 640047 und Tasche Art. 122522	<b>set</b> of single track luggage bicycle trailer art. 640047 and bag art. 122522 <p style="text-align: right;">UVP 239,00 €</p>
640002 100 set	<b>Adapter für Steckachsen ›Stalwart Thru‹</b> <ul style="list-style-type: none"> <li>• ermöglicht die Verwendung des <b>Einspur-Gepäckanhängers</b> (Art. 640047) in Verbindung mit einer <b>Steckachse</b> mit Innengewinde (Art. 640140, 640141, 640142)</li> <li>• im Polybeutel mit M-Wave Eurolochheader</li> </ul>	<b>adapter for thru axles ›Stalwart Thru‹</b> <ul style="list-style-type: none"> <li>• enables usage of the <b>single track luggage trailer</b> (art. 640047) in connection with <b>thru axles</b> with internal thread (art. 640140, 640141, 640142)</li> <li>• in PE bag with M-Wave eurohole header</li> </ul> <p style="text-align: right;">UVP 29,90 €</p>



122522 passende Tasche/bag for trailer



640076 Verbindungsstab/connector stem

640127 Sicherheitshaken/safety hook

ART.-NR. 	BESCHREIBUNG	DESCRIPTION
<p><b>640046</b></p> <p>1</p>	<p><b>KINDER-, GEPÄCK- UND JOGGING FAHRRADANHÄNGER/-WAGEN ›STALWART KID 3IN1‹</b></p> <ul style="list-style-type: none"> <li>• in Sekunden, <b>ohne Werkzeug</b> umbaubar vom <b>Fahrradanhänger zum Kinderwagen oder Jogger</b></li> <li>• <b>20"</b> Laufräder mit <b>Schnellverschluss</b> und <b>Sicherheitsbügel</b></li> <li>• <b>zusätzliches 12" Laufrad</b></li> <li>• mit feststellbarer <b>Handbremse</b></li> <li>• mit <b>Wegfahrsperr</b></li> <li>• <b>faltbar</b></li> <li>• Bespannung aus 600 D Polyestergerewebe</li> <li>• mit <b>Sicherheitsreflexdreieck</b> auf der Rückseite</li> <li>• mit Reflektoren</li> <li>• 2-sitzig mit Sicherheitsgurten und Überrollbügel</li> <li>• abnehmbare Überdachung, mit Dachfenster (Art. 640016)</li> <li>• mit Fliegengitter</li> <li>• mit Wimpel</li> <li>• mit Regenschutz</li> <li>• mit zusätzlichem Stauraum für Gepäck</li> <li>• mit 2 Innentaschen für Kleinutensilien</li> <li>• mit <b>Schnellverschluss</b> Universal-Kupplung für's Fahrrad</li> <li>• geprüft gemäß EN 15918</li> <li>• max. Zuladung bei Gebrauch als Jogger: 32,2 kg</li> <li>• max. Zuladung als Anhänger: 20,2 kg</li> <li>• Außenmaße: 61 cm (B) x 75 cm (L) x 28 cm (Sitzhöhe)</li> </ul>	<p><b>CHILDREN, LUGGAGE AND JOGGING BICYCLE TRAILER/VAN ›STALWART KID 3IN1‹</b></p> <p><b>3 in 1</b></p> <ul style="list-style-type: none"> <li>• in seconds, <b>toolless</b> changeable from <b>bicycle trailer to baby van or jogger</b></li> <li>• <b>20"</b> wheels with <b>quick release</b> and <b>safety bow</b></li> <li>• <b>additional 12" wheel</b></li> <li>• with fixable <b>handbrake</b></li> <li>• with <b>parking brake</b></li> <li>• <b>foldable</b></li> <li>• covering made of 600 D polyester</li> <li>• with <b>safety reflex triangle</b> on the back</li> <li>• with reflectors</li> <li>• 2 seats with safety belts and with roll-over bar</li> <li>• with detachable roof, with window (art. 640016)</li> <li>• with fly-screen</li> <li>• with pennant</li> <li>• with rain protection</li> <li>• with additional room for luggage</li> <li>• with 2 inside pockets for small parts</li> <li>• with universal <b>quick release</b> adapter for bicycle</li> <li>• tested according to EN 15918</li> <li>• max. load when using as jogger: 32.2 kg</li> <li>• max. load as trailer: 20.2 kg</li> <li>• measurement outside: 61 cm (W) x 75 cm (L) x 28 cm (seat height)</li> </ul> <p>UVP 395,00 €</p>



<p><b>640092</b></p> <p>1</p>	<p><b>GEFEDERTER ALUMINIUM KINDER- UND GEPÄCK-FAHRRADANHÄNGER ›STALWART KID 2‹</b></p> <ul style="list-style-type: none"> <li>• mit faltbarem <b>Aluminium</b>-Rahmen</li> <li>• <b>vollgefedert</b></li> <li>• <b>20"</b> Laufräder mit <b>Schnellverschluss</b></li> <li>• <b>Aluminium</b>felgen</li> <li>• Bespannung aus 600D Polyestergerewebe</li> <li>• mit <b>Sicherheitsreflexdreieck</b> auf der Rückseite</li> <li>• mit Reflektoren</li> <li>• 2-sitzig mit Sicherheitsgurten</li> <li>• mit Überrollbügel</li> <li>• abnehmbare Überdachung (Art. 640016)</li> <li>• mit Fliegengitter und Regenschutz</li> <li>• mit Wimpel</li> <li>• mit zusätzlichem Stauraum für Gepäck</li> <li>• mit 2 Innentaschen für Kleinutensilien</li> <li>• mit <b>Schnellverschluss</b> Universal-Kupplung für's Fahrrad</li> <li>• geprüft gemäß EN 15918</li> <li>• max. Zuladung: 20 kg</li> <li>• Außenmaße: 60 cm (B) x 75 cm (L) x 28 cm (Sitzhöhe)</li> </ul>	<p><b>SUSPENSION ALUMINIUM CHILDREN AND LUGGAGE BICYCLE TRAILER ›STALWART KID 2‹</b></p> <ul style="list-style-type: none"> <li>• with foldable <b>aluminium</b> frame</li> <li>• <b>full suspension</b></li> <li>• <b>20"</b> wheels with <b>quick release</b></li> <li>• <b>aluminium</b> rims</li> <li>• covering made of 600D polyester</li> <li>• with <b>safety reflex triangle</b> on the back</li> <li>• with reflectors</li> <li>• 2 seats with safety belts</li> <li>• with roll-over bar</li> <li>• with detachable roof (art. 640016)</li> <li>• with fly-screen and rain protection</li> <li>• with pennant</li> <li>• with additional room for luggage</li> <li>• with 2 inside pockets for small parts</li> <li>• with universal <b>quick release</b> adapter for bicycle <ul style="list-style-type: none"> <li>• tested according to EN 15918</li> <li>• maximal load: 20 kg</li> </ul> </li> <li>• measurement outside: 60 cm (W) x 75 cm (L) x 28 cm (seat height)</li> </ul> <p>UVP 459,00 €</p>
-------------------------------	---	--



ART.-NR.	BESCHREIBUNG	DESCRIPTION
	<b>KINDER- UND GEPÄCK-FAHRRADANHÄNGER</b> <ul style="list-style-type: none"> <li>• <b>faltbar</b></li> <li>• <b>20" Räder mit Schnellverschluss</b></li> <li>• <b>Sicherheitsrahmen um die Laufräder</b></li> <li>• Bespannung aus 600D Polyestergewebe</li> <li>• mit <b>Sicherheitsreflexdreieck</b> auf der Rückseite</li> <li>• mit Reflektoren</li> <li>• 2-sitzig mit Sicherheitsgurten</li> <li>• mit Überrollbügel</li> <li>• mit abnehmbarer Überdachung (Art. 640016)</li> <li>• mit Fliegengitter</li> <li>• mit Wimpel</li> <li>• mit Regenschutz</li> <li>• mit zusätzlichem Stauraum für Gepäck</li> <li>• mit 2 Innentaschen für Kleinutensilien</li> <li>• mit <b>Schnellverschluss</b> Universal-Kupplung für's Fahrrad</li> <li>• geprüft gemäß EN 15918</li> <li>• max. Zuladung: 20 kg</li> <li>• Außenmaße: 60 cm (B) x 75 cm (L) x 28 cm (Sitzhöhe)</li> </ul>	<b>CHILDREN AND LUGGAGE BICYCLE TRAILER</b> <ul style="list-style-type: none"> <li>• <b>foldable</b></li> <li>• <b>20" wheels with quick release</b></li> <li>• <b>safety frame around the wheels</b></li> <li>• covering made of 600D polyester</li> <li>• with <b>safety reflex triangle</b> on the back</li> <li>• with reflectors</li> <li>• 2 seats with safety belts</li> <li>• with roll-over bar</li> <li>• with detachable roof (art. 640016)</li> <li>• with fly-screen</li> <li>• with pennant</li> <li>• with rain protection</li> <li>• with additional room for luggage</li> <li>• with 2 inside pockets for small parts</li> <li>• with universal <b>quick release</b> adapter for bicycle</li> <li>• tested according to EN 15918</li> <li>• max. load: 20 kg</li> <li>• measurement outside: 60 cm (W) x 75 cm (L) x 28 cm (seat height)</li> </ul>
640091	›STALWART KID EASY LIGHT‹ Aluminium-Rahmen	›STALWART KID EASY LIGHT‹ aluminium frame <span style="float: right;">UVP 389,00 €</span>
640090 1	›STALWART KID EASY‹ Stahlrahmen	›STALWART KID EASY‹ steel frame <span style="float: right;">UVP 359,00 €</span>



640050 1	<b>HUNDEFAHRRADANHÄNGER</b> ›STALWART PET‹	<b>DOG BICYCLE TRAILER</b> ›STALWART PET‹
	<ul style="list-style-type: none"> <li>• <b>faltbar</b></li> <li>• 16" Räder mit <b>Schnellverschluss</b></li> <li>• Bespannung aus 600D Polyestergewebe (Ersatzüberdachung Art. 640001)</li> <li>• zusätzliche/s <b>Fronttür/Sichtfenster</b></li> <li>• mit <b>Befestigungsöse</b> für Hundeleine innen</li> <li>• mit <b>Überrollbügel</b></li> <li>• mit Wimpel</li> <li>• mit Regenschutz</li> <li>• mit <b>Schnellverschluss</b> Universal-Kupplung für's Fahrrad</li> <li>• mit faltbarer Anhängestange</li> <li>• max. Zuladung: 30 kg</li> <li>• Außenmaße: 43,5 cm (B) x 68 cm (L) x 51,5 cm (H), gefaltet: Höhe ca. 19 cm</li> </ul>	<ul style="list-style-type: none"> <li>• <b>foldable</b></li> <li>• 16" wheels with <b>quick release</b></li> <li>• covering made of 600D polyester (replacement canopy art. 640001)</li> <li>• additional <b>front door/window</b></li> <li>• with <b>fastening eye</b> inside for a dog leash</li> <li>• with <b>roll-over bar</b></li> <li>• with pennant</li> <li>• with rain protection</li> <li>• with universal <b>quick release</b> adapter for bicycle</li> <li>• with foldable tow bar</li> <li>• max. load: 30 kg</li> <li>• measurement outside: 43.5 cm (W) x 68 cm (L) x 51.5 cm (H), folded: height approx. 19 cm</li> </ul> <span style="float: right;">UVP 239,00 €</span>













ART.-NR.	BESCHREIBUNG	DESCRIPTION	
<p><b>640140</b> 50</p> <p><b>640141</b> 50</p> <p><b>640142</b> 50</p>	<p><b>STECKACHSE FÜR ANHÄNGER-KUPPLUNG</b> ›STALWART AXLE‹</p> <ul style="list-style-type: none"> <li>zur <b>werkzeuglosen Montage von Standard Fahrrad-Anhänger-Kupplungen</b> an <b>12 mm Steckachs-naben</b></li> <li><b>2 in 1:</b> durch 6 mm Distanzscheibe passend für 12 mm Steckachs-naben mit <b>142 mm</b> Einbaumaß und für <b>Boost-Naben</b> mit <b>148 mm</b> Einbaumaß</li> <li>Aluminium</li> <li>mit Schnellspanner</li> <li>auch <b>ohne Schnellspanner als saubere Lösung</b> für Steckachsen nutzbar</li> <li>mit <b>zusätzlichem Innengewinde</b> für M6-Schraube für z. B. Gepäckträgermontage</li> <li>mit zusätzlichen Unterlegscheiben zur <b>Einstellung der Schnellspannhebel-Position</b></li> <li>auf M-Wave Eurolochkarte</li> </ul> <p><b>Shimano Type</b> (kein original Shimano Ersatzteil) Gewindesteigung: P1.5 x T20</p> <p><b>Maxle Type</b> (kein original Maxle Ersatzteil) Gewindesteigung: P1.75 x T20</p> <p><b>Syntaxe Type</b> (kein original Syntaxe Ersatzteil) Gewindesteigung: P1.0 x T20 mit konischer Verbindungsscheibe</p>	<p><b>THRU AXLE FOR TRAILER MOUNT</b> ›STALWART AXLE‹</p> <ul style="list-style-type: none"> <li>for <b>toolless mounting of standard bicycle trailer adapters at 12 mm thru axle hubs</b></li> <li><b>2 in 1:</b> by 6 mm spacer suitable for 12 mm thru axle hubs with OLD <b>142 mm</b> and for <b>boost hubs</b> with OLD <b>148 mm</b></li> <li>aluminium</li> <li>with QR</li> <li>also usable <b>without QR as clean solution</b> for quick-release axle</li> <li>with <b>additional internal thread</b> for M6 screw for e. g. luggage rack mounting</li> <li>with additional spacers for <b>adjusting the QR lever position</b></li> <li>on M-Wave eurohole card</li> </ul> <p><b>Shimano Type</b> (no original Shimano spare part) thread pitch: P1.5 x T20 UVP 44,90 €</p> <p><b>Maxle Type</b> (no original Maxle spare part) thread pitch: P1.75 x T20 UVP 44,90 €</p> <p><b>Syntaxe Type</b> (no original Syntaxe spare part) thread pitch: P1.0 x T20 with conical spacer UVP 44,90 €</p>	<p><b>BOOST</b></p> <p><b>BOOST 148 MM</b></p> <p><b>NON BOOST 142 MM</b></p> <p>M6</p> <p>1:1</p> <p>1:1</p> <p>1:1</p>
<p><b>440490</b> 100</p>	<p><b>SCHNELLSPANNER</b></p> <ul style="list-style-type: none"> <li>zur <b>Montage von Gepäckträgern</b> an Räder:</li> <li><b>ohne Befestigungsösen</b> (z. B. Rennräder)</li> <li>mit <b>hinderlichen Sitzrohr- oder Kettenstreben, Ausfallenden, ...</b></li> <li>passend auch für <b>Fahrradanhänger</b> Art. 640050, ...</li> <li>mit 8 je 5 mm breiten <b>Adapter-scheiben</b></li> <li><b>Aluminiumhebel</b></li> <li>Länge 210 mm</li> <li>für Nabeneinbaumaß: <math>\geq 130</math> mm</li> <li><b>Klemmbreite: 137 mm - 177 mm</b> (in 5 mm Schritten)</li> <li>auf M-Wave Eurolochkarte</li> </ul>	<p><b>QUICK RELEASE</b></p> <ul style="list-style-type: none"> <li>for <b>mounting of carriers</b> to bicycles:</li> <li><b>without mounting eyelets</b> (e. g. road bikes)</li> <li>with <b>obstructive seat stays, chain stays, derailleur hangers, ...</b></li> <li>also suitable for <b>bicycle trailer</b> art. 640050, ... with 8 <b>adapters</b>, each 5 mm wide</li> <li><b>aluminium lever</b></li> <li>length 210 mm</li> <li>OLD: <math>\geq 130</math> mm</li> <li><b>clamp width: 137 - 177 mm</b> (in 5 mm steps)</li> <li>on M-Wave eurohole card</li> </ul> <p>UVP 9,90 €</p>	<p>137 - 177 mm</p>
<p><b>640104</b> 5</p>	<p><b>HUNDELEINENFÜHRUNG-STANGE</b> ›DOG WALK‹</p> <ul style="list-style-type: none"> <li>stabile Feder</li> <li>Befestigung an der Sattelstütze, Sattelrohr, ...</li> <li><b>Schnellspanverschluss</b></li> <li>inkl. Hundeleine 92 cm</li> <li>auf M-Wave Eurolochkarte</li> </ul>	<p><b>DOG GUIDE</b> ›DOG WALK‹</p> <ul style="list-style-type: none"> <li>stable spring</li> <li>attachment at the seatpost, seat tube, ...</li> <li><b>quick release</b></li> <li>incl. dog leash 92 cm</li> <li>with M-Wave eurohole card</li> </ul> <p>UVP 26,90 €</p>	



# TRAIL-GATOR™

THE BICYCLE TOW BAR













ART.-NR. 	BESCHREIBUNG	Das Original! The Original!	DESCRIPTION
	<b>TANDEMSTANGE TRAIL-GATOR</b> Radtouren gemeinsam oder getrennt erleben: bei Bedarf kann fast <b>jedes handelsübliche Kinderfahrrad an jedes handelsübliche Erwachsenenfahrrad</b> angehängt werden! • auch als <b>Lernhilfe</b> oder Abschleppstange nutzbar • <b>werkzeugloses An- und Abhängen</b> des Kinderrads • mit <b>Schnellspanner</b> , schnell von der Sattelstütze zu lösen • stabile Konstruktion • passend für <b>12" - 20"</b> Kinderräder • max. Belastung 32 kg (Gewicht des Kindes) • Kind kann mittreten oder sich ziehen lassen • Lenker des Kinderrads während der Benutzung fixierbar • <b>platzsparende Lagerung</b> und leichter Transport durch Zusammenschieben der Stange möglich • Farbe: rot		<b>TANDEM TRAIL-GATOR TOW BAR</b> • Ride attached or separately: almost <b>every commercially available children's bike</b> can be attached to <b>every commercially available adult's bike!</b> • used as a <b>learning aid</b> or a tow bar • <b>toolless</b> children's bike <b>attachment or removal</b> • with <b>quick release</b> , fast to detach of seat post • stable construction • suitable for <b>12" - 20"</b> kids bikes • max. load 32 kg (weight of the child) • child can ride with an adult or be pulled • handlebar can be affixed during use • <b>space saving storage</b> and easy transport by retracting the tow bar • colour: red
640020	Box und Handbuch mit <b>zehn westeuropäischen Sprachen</b> (DE, DK, EN, ES, FR, IT, NL, NO, PT, SV)		box and manual with <b>10 Western European languages</b> (DE, DK, EN, ES, FR, IT, NL, NO, PT, SV)
640025	Box und Handbuch mit <b>zehn mittel-/osteuropäischen Sprachen</b> (BG, CZ, DE, EN, HU, PL, RO, RU, SK, UA)		box and manual with <b>10 Central/Eastern European languages</b> (BG, CZ, DE, EN, HU, PL, RO, RU, SK, UA) UVP 109,00 €
	<b>ZWEIT-, ERSATZTEILE</b>		<b>EXTRA, REPLACEMENT PARTS</b>
640203	Halterung für Sattelstütze Ø 25,4 - 31,8 mm, z. B. um Tandem-Stange mit einem Zweitrad zu benutzen (10250)		bracket for seat pillar Ø 25.4 - 31.8 mm, e.g. set to attach tow bar at another bike (10250)  UVP 43,90 €
640205	Adapter-Set für Kinderrad mit Steuersatzrohr bis Ø 45 mm, auch passend für Oversize-Rahmen bis Ø 45 mm (10230)		adapter set for children bikes with head set tube up to Ø 45 mm, also for oversize frame to Ø 45 mm (10230)  UVP 44,90 €
640299	Transporthalterung für Trailgatorstange am Erwachsenenrad (Hinterradnabe)		storage bracket at the rear hub of the adult bike  UVP 8,90 €
640204	Fixierstange mit Schelle		fixing rod with clamp  UVP 21,90 €
640208	Kugelkopfschrauben-Set für Fixierstange mit Gabelschellen		ball joint bolt + washer + nut, with fork clamps  UVP 23,90 €
640029	Sicherungsstift für Teleskopstange		safety pin for telescope tube  UVP 5,90 €
439985	<b>Stützräder ›FLIP-UP‹</b> für Kinder-Fahrräder, <b>hochklappbar ohne Werkzeug</b> , passend für <b>12" - 20"</b> , paarweise in Displayverpackung (10310)		<b>stabilizer ›FLIP-UP‹</b> for children bikes, <b>foldable type without tool</b> , for <b>12" - 20"</b> , one pair in a display packaging (10310)  UVP 53,90 €
360904	Adapter für Kinderräder mit Cantileverbremse (10270)		adapter for children bikes with cantilever brake (10270)  UVP 5,90 €

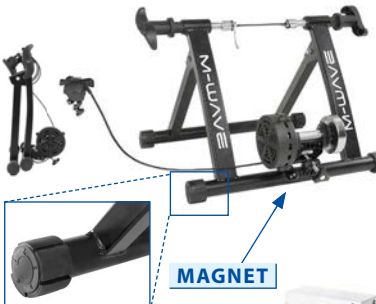



ART.-NR.	BESCHREIBUNG	DESCRIPTION	
<p><b>640026</b> 20</p> <p><b>640027</b> 20</p> <p><b>NEW</b></p>	<p><b>FAHRRAD-ABSCHLEPPSEIL</b> <b>&gt;TRAIL ROPE&lt;</b></p> <ul style="list-style-type: none"> <li>• <b>Abschlepphilfe</b> für z. B. Kinder, Jugendliche, Erwachsene, ...</li> <li>• <b>enorme Belastbarkeit</b> durch Nylonummantelung</li> <li>• mit <b>Bungee-Gummiband</b> für sanftes Anfahren</li> <li>• inkl. 2 Karabinerhaken und 2 Gurtbänder für einfache, werkzeuglose Montage an Sattel oder Sattelstütze des Zugrads und an Lenker, Vorbau oder Rahmendreieck des gezogenen Fahrrads</li> <li>• inkl. Tasche zur Befestigung am Sattelgestell, Rahmen, ...</li> <li>• im M-Wave Einzelkarton</li> </ul> <p>besonders geeignet für <b>schwere</b> Anhängelasten (<b>Erwachsene</b>, ...), für bis zu 170 kg Gesamtanhängelast empfohlen</p> <p>besonders geeignet für <b>leichtere</b> Anhängelasten (<b>Kinder / Jugendliche</b>, ...), für bis zu 100 kg Gesamtanhängelast empfohlen</p>	<p><b>BICYCLE TOW ROPE</b> <b>&gt;TRAIL ROPE&lt;</b></p> <ul style="list-style-type: none"> <li>• <b>tow assist</b> for e. g. children, youths, adults, ...</li> <li>• <b>huge resilience</b> due to nylon coating</li> <li>• with <b>bungee rubber band</b> for gentle start</li> <li>• incl. 2 carabiners and 2 webbing bands for easy, toolless mounting on saddle or seat post of the towing bike and on handlebars, handle stem or frame triangle of the towed bike</li> <li>• incl. storage bag for mounting to the saddle rail, frame, ...</li> <li>• in M-Wave box</li> </ul> <p>especially suitable for <b>heavy</b> trailer loads (<b>adults</b>, ...), recommended for up to 170 kg total load</p> <p>especially suitable for <b>lighter</b> trailer loads (<b>kids / youths</b>, ...), recommended for up to 100 kg total load</p> <p>UVP 39,90 €</p>	    
<p><b>640156</b> 50</p> <p><b>NEW</b></p>	<p><b>HÜFTGURT</b> <b>&gt;TRAIL ROPE HIKING STRAP&lt;</b></p> <ul style="list-style-type: none"> <li>• <b>einstellbarer</b> Hüftgurt für <b>universellen</b> Einsatz</li> <li>• für Abschleppseil Art. 640026/7</li> <li>• ca. 40 x 1.330 mm</li> <li>• auf M-Wave Eurolochkarte</li> </ul>	<p><b>HIPBELT</b> <b>&gt;TRAIL ROPE HIKING STRAP&lt;</b></p> <ul style="list-style-type: none"> <li>• <b>adjustable</b> hipbelt for <b>universal</b> usage</li> <li>• for tow rope art. 640026/7</li> <li>• approx. 40 x 1,330 mm</li> <li>• on M-Wave eurohole card</li> </ul> <p>UVP 11,90 €</p>	   
<p><b>659690</b> 1</p> <p><b>NEW</b></p>	<p><b>SMART TRAINER</b> <b>&gt;THINKRIDER&lt;</b></p> <ul style="list-style-type: none"> <li>• anwendbar für 24"-29"</li> <li>• stabiler Stahlrahmen</li> <li>• Funkübertragung per <b>ANT+, ANT+ FE-C, Bluetooth Smart</b></li> <li>• kompatible Betriebssysteme: <b>iOS, Android und Windows</b></li> <li>• <b>Virtual Reality kompatibel</b></li> <li>• <b>extra breite Standfüße</b> und <b>5° Schwungbereich</b> ermöglichen auch <b>Wiegetritt</b> fahren</li> <li>• die integrierte <b>elastische Schwingung</b> <b>sorgt für reales Fahrvergnügen</b></li> <li>• <b>elektromagnetischer Widerstand</b></li> <li>• max. Steigung 16 %</li> <li>• max. <b>Wattleistung 2.500 W</b></li> <li>• passend für Naben mit 130/135/142/148 mm Einbaubreite</li> <li>• mit Standard Shimano Kassettenkörper</li> <li>• kompatibel mit 8-12-fach, XD und XDR</li> <li>• 22 kg</li> <li>• im Thinkrider Einzelkarton</li> </ul> <p>optionales Zubehör: Bodenmatte, Herzfrequenz-Arm- oder Brustband, Rocking-Board, PC-Tisch, Schweißfänger, ...</p>	<p><b>SMART TRAINER</b> <b>&gt;THINKRIDER&lt;</b></p> <ul style="list-style-type: none"> <li>• suitable for 24"-29"</li> <li>• stable steel frame</li> <li>• wireless technology: <b>ANT+, ANT+ FE-C, Bluetooth Smart</b></li> <li>• devices: <b>iOS, Android and Windows</b></li> <li>• <b>virtual reality compatible</b></li> <li>• <b>extra wide feet</b> and a <b>5° swing range</b> enable you to <b>ride out of the saddle</b></li> <li>• the <b>integrated elastic vibration</b> <b>simulates real cycling sense</b></li> <li>• <b>electromagnetic resistance</b></li> <li>• maximum incline 16 %</li> <li>• max. <b>wattage 2,500 W</b></li> <li>• for hub types 130/135/142/148 mm</li> <li>• with standard Shimano cassette body</li> <li>• compatible with 8-12 speed XD and XDR</li> <li>• 22 kg</li> <li>• in Thinkrider box</li> </ul> <p>optional accessories: floor mat, heart rate wristband or chest band, rocking board, trainer table, sweat catcher, ...</p> <p>UVP 1.069,00 €</p>	   

ART.-NR. 	BESCHREIBUNG	DESCRIPTION	
<b>659688</b> 1	<b>TRAININGSROLLE ›YOKE ´N´ROLL 65‹</b> <ul style="list-style-type: none"> <li>• <b>Gabel</b> mit Schnellspanner sicher und einfach <b>fixierbar</b></li> <li>• für <b>26" - 29"</b></li> <li>• <b>Länge werkzeuglos an Radstand anpassbar</b></li> <li>• leises Laufgeräusch</li> <li>• Trainingseffekt über Gangschaltung am Rad <b>veränderbar</b></li> <li>• kleiner Tritt zum leichteren Aufsteigen</li> <li>• platzsparende Aufbewahrung, da zusammenschiebbar</li> <li>• werkzeuglose und schnelle (De-)Montage</li> <li>• im Einzelkarton</li> </ul>	<b>ROLL EXERCISE TRAINER ›YOKE ´N´ROLL 65‹</b> <ul style="list-style-type: none"> <li>• <b>fork</b> can be <b>fixed</b> safely and easily with quick release</li> <li>• for <b>26" - 29"</b></li> <li>• <b>length can be adapted to the wheel-base without tools</b></li> <li>• low noise emission</li> <li>• training effect <b>can be changed</b> via gear shift on the bike</li> <li>• mini step for easy access</li> <li>• space-saving storage due to foldability</li> <li>• toolless and fast (dis-)assembly</li> <li>• in box</li> </ul> <p style="text-align: right;">UVP 179,00 €</p>	  
<b>659687</b> 1	<b>ROLLENTRAINER ›YOKE ´N´ROLL 10‹</b> <ul style="list-style-type: none"> <li>• 2 oversized Stahl-Standrohre mit zusätzlicher Seitenabstützung</li> <li>• ergonomische <b>Schnelleinspann-</b> und Einstellgriffe</li> <li>• für <b>26" - 29"</b></li> <li>• einstellbare <b>Magnetbremse</b></li> <li>• leises Laufgeräusch</li> <li>• Widerstand <b>8-fach verstellbar mit Fernbedienung</b> (für Lenker Ø 22,2 - 31,8 mm)</li> <li>• <b>zusammenklappbar</b></li> <li>• im Einzelkarton</li> </ul>	<b>ROLL EXERCISE TRAINER ›YOKE ´N´ROLL 10‹</b> <ul style="list-style-type: none"> <li>• 2 oversized steel main tubes with additional side stability tubes</li> <li>• ergonomic <b>quick mounting</b> and adjusting handles</li> <li>• for <b>26" - 29"</b></li> <li>• adjustable <b>magnet brake</b></li> <li>• low noise emission</li> <li>• resistance <b>adjustable in 8 steps with remote</b> (for handlebar Ø 22.2 - 31.8 mm)</li> <li>• <b>foldable</b></li> <li>• in box</li> </ul> <p style="text-align: right;">UVP 148,00 €</p>	  
<b>659686</b> 1	<b>ROLLENTRAINER ›YOKE ´N´ROLL 60‹</b> <ul style="list-style-type: none"> <li>• 2 oversized Stahl-Standrohre mit Seitenabstützung</li> <li>• ergonomische Einspann- und Einstellgriffe</li> <li>• inkl. <b>Schnellspanner</b></li> <li>• für <b>26" - 29"</b></li> <li>• einstellbare <b>Magnetbremse</b> durch Anpressdruck</li> <li>• <b>leises Laufgeräusch</b></li> <li>• <b>klappbar</b></li> <li>• im Einzelkarton</li> </ul>	<b>ROLL EXERCISE TRAINER ›YOKE ´N´ROLL 60‹</b> <ul style="list-style-type: none"> <li>• 2 oversized steel main tubes with side stability tubes</li> <li>• ergonomic mounting and adjusting handles</li> <li>• incl. <b>quick release</b></li> <li>• for <b>26" - 29"</b></li> <li>• adjustable <b>magnet brake</b> by contact pressure</li> <li>• <b>low noise emission</b></li> <li>• <b>foldable</b></li> <li>• in box</li> </ul> <p style="text-align: right;">UVP 139,00 €</p>	  
<b>659689</b> 40	<b>UNTERLEGBLOCK</b> <ul style="list-style-type: none"> <li>• zum <b>Niveaueausgleich des Vorderrads</b> bei Benutzung eines Rollentainers</li> <li>• passend für <b>alle Rollentainer</b></li> <li>• V-Form für seitliche Stabilität</li> <li>• Kunststoff</li> <li>• Montageverpackung</li> </ul>	<b>LEVELLING BLOCK</b> <ul style="list-style-type: none"> <li>• for <b>levelling the front wheel</b> when using an exercise trainer</li> <li>• suitable for <b>all roll exercise trainers</b></li> <li>• V-shape for lateral stability</li> <li>• plastic</li> <li>• OEM</li> </ul> <p style="text-align: right;">UVP 7,90 €</p>	





# SCOOTER

ART.-NR. 	BESCHREIBUNG	DESCRIPTION	
	<b>E-SCOOTER ›SL‹</b> <ul style="list-style-type: none"> <li>• kraftvoller <b>350 W Motor</b> (bürstenlos) bis <b>25 km/h</b></li> <li>• mit 8,5" <b>Luftbereifung</b> für erstklassigen Fahrkomfort</li> <li>• <b>Scheibenbremse hinten</b> / elektrische Bremse vorne</li> <li>• zusätzliche Pedalbremse hinten</li> <li>• leichter und stabiler Rahmen aus Edelstahl</li> <li>• nur <b>12 kg</b> Gesamtgewicht</li> <li>• in Sekundenschnelle zusammengeklappt</li> <li>• mit <b>LED-Beleuchtung</b> vorne und hinten</li> <li>• <b>Lithium-Ionen Akku</b> (230 Wh/6,4 Ah) mit bis zu <b>25 km Reichweite</b> (in Abhängigkeit von Fahrergewicht, Wegbeschaffenheit etc.)</li> <li>• <b>leicht entnehmbarer Akku in der Lenksäule</b>, wassergeschützt untergebracht (IP54)</li> <li>• Akku kann sowohl im E-Scooter als auch außerhalb geladen werden</li> <li>• Ladezeit nur 2-3 Stunden</li> <li>• mit Seitenständer</li> <li>• bis <b>100 kg Fahrergewicht</b></li> <li>• inkl. Ladegerät mit <b>EU-</b> und <b>UK-</b>Stecker</li> <li>• im Einzelkarton</li> </ul>	<b>E-SCOOTER ›SL‹</b> <ul style="list-style-type: none"> <li>• powerful <b>350 W engine</b> (brushless) up to <b>25 km/h</b></li> <li>• with 8.5" <b>air tires</b> for first class riding comfort</li> <li>• <b>rear disc brake</b> / electric brake at the front</li> <li>• additional rear pedal brake</li> <li>• light and strong frame made of stainless steel</li> <li>• only <b>12 kg</b> total weight</li> <li>• foldable in seconds</li> <li>• with front and rear <b>LED lights</b></li> <li>• <b>Li-Ion rechargeable battery</b> (230 Wh/6.4 Ah) with max. <b>25 km range</b> (depending on the rider weight, trail conditions etc.)</li> <li>• <b>easily removable battery in the steering column</b>, water-protected housed (IP54)</li> <li>• battery can be charged in the e-scooter or separately</li> <li>• charging time only 2-3 hours</li> <li>• with side stand</li> <li>• up to <b>100 kg riders weight</b></li> <li>• incl. charger with <b>EU</b> and <b>UK</b> plugin box</li> </ul>	
<b>659885</b>	schwarz	black	
<b>659886</b>	silber	silver	
1	Verkauf und Nutzung im Geltungsbereich der StVZO (Deutschland) unzulässig.	UVP 699,00 €	
	<b>ERSATZTEILE FÜR E-SCOOTER ›SL‹</b>	<b>REPLACEMENT PARTS FOR E-SCOOTER ›SL‹</b>	
<b>659884</b>	Akku, 216 Wh/6,4 Ah	rechargeable battery, 216 Wh/6.4 Ah	UVP 299,00 €
1			
<b>659851</b>	Ladegerät	charger	UVP 29,90 €
100			
<b>659857</b>	Akku-Tasche	battery bag	UVP 13,90 €
100			
<b>659852</b>	Bremsbeläge	brake pads	UVP 7,99 €
100			
<b>659856</b>	Bremsarmatur	brake instruments	UVP 14,90 €
100			
<b>659855</b>	Motor	motor	UVP 99,90 €
10			
<b>659873</b>	Ersatzreifen	replacement tire	UVP 12,90 €
50			
<b>659850</b>	Controller	controller	UVP 49,90 €
100			
<b>659853</b>	Schutzblech vorne	front mudguard	UVP 4,99 €
100			
<b>659854</b>	Schutzblech hinten, inkl. Bremsbelag	rear mudguard, incl. brake pad	UVP 13,90 €
100			









ART.-NR.	BESCHREIBUNG	DESCRIPTION	
<b>659905</b> 1	<b>E-SCOOTER ›E9X‹</b> <ul style="list-style-type: none"> <li>• kraftvoller <b>250 W Motor</b> (bürstenlos) bis <b>20 km/h</b></li> <li>• mit 8,5" <b>Luftbereifung</b> für erstklassigen Fahrkomfort</li> <li>• <b>Scheibenbremse hinten</b> / elektrische Bremse vorne</li> <li>• leichter, stabiler Aluminiumrahmen</li> <li>• nur <b>12,5 kg</b> Gesamtgewicht</li> <li>• in Sekundenschnelle zusammengeklappt</li> <li>• mit <b>LED-Beleuchtung</b> vorne und hinten</li> <li>• <b>Lithium-Ionen Akku</b> (216 Wh/6 Ah) mit bis zu <b>18 km Reichweite</b></li> <li>• mit Seitenständer</li> <li>• inkl. Glocke</li> <li>• mit Nummernschild-Halter</li> <li>• bis <b>100 kg Fahrergewicht</b></li> <li>• inkl. Ladegerät mit <b>EU-</b> und <b>UK-</b>Stecker</li> <li>• im Einzelkarton</li> </ul> <p>Verkauf und Nutzung im Geltungsbereich der StVZO (Deutschland) unzulässig.</p>	<b>E-SCOOTER ›E9X‹</b> <ul style="list-style-type: none"> <li>• powerful <b>250 W engine</b> (brushless) up to <b>20 km/h</b></li> <li>• with 8.5" <b>air tires</b> for first class riding comfort</li> <li>• <b>rear disc brake</b> / electric brake at the front</li> <li>• light, strong aluminium frame</li> <li>• only <b>12.5 kg</b> total weight</li> <li>• foldable in seconds</li> <li>• with front and rear <b>LED lights</b></li> <li>• <b>Li-Ion rechargeable battery</b> (216 Wh/6 Ah) with max. <b>18 km range</b></li> <li>• with side stand</li> <li>• incl. bell</li> <li>• with number plate bracket</li> <li>• up to <b>100 kg riders weight</b></li> <li>• incl. charger with <b>EU</b> and <b>UK</b> plugin box</li> </ul> <p>UVP 529,00 €</p>	
	<b>ERSATZTEILE FÜR E-SCOOTER ›E9X‹</b>	<b>REPLACEMENT PARTS FOR E-SCOOTER ›E9X‹</b>	
<b>659862</b> 100	Ständer	stand	UVP 7,90 €
<b>659863</b> 30	Bremsscheibe	brake disc	UVP 9,90 €
<b>659864</b> 100	Schlauch	tube	UVP 5,90 €
<b>659873</b> 50	Ersatzreifen	replacement tire	UVP 12,90 €
<b>659869</b> 10	Vorderrad mit Motor	frontwheel with motor	UVP 109,00 €
<b>659887</b> 100	Display-Abdeckung	display cover	UVP 3,90 €
<b>659867</b> 100	Frontlicht	front light	UVP 6,90 €
<b>659870</b> 100	Rücklichtglas	rear light glass	UVP 0,99 €
<b>659874</b> 500	Reflektoraufkleber	reflector sticker	UVP 1,49 €
	<b>ZUBEHÖR FÜR E-SCOOTER</b>	<b>ACCESSORIES FOR E-SCOOTER</b>	
<b>122888</b> 20	<b>Scoter-/Lenkertasche</b> ›Suburban messenger compact‹ (siehe Seite 27)	<b>scooter/handlebar bag</b> ›Suburban messenger compact‹ (see page 27)	UVP 19,90 €
<b>122580</b> 132	<b>Halter für mobile Endgeräte</b> ›Bike Mount Flex‹ (siehe Seite 36)	<b>bracket for mobile devices</b> ›Bike Mount Flex‹ (see page 36)	UVP 11,90 €
<b>122739</b> 50	<b>Schultergurt für E-Scooter / Falträder</b> <ul style="list-style-type: none"> <li>• z. B. für Art. 659905/659885/6,...</li> <li>• im Polybeutel mit Einleger (siehe Seite 29)</li> </ul>	<b>shoulder strap for e-scooter / folding bikes</b> <ul style="list-style-type: none"> <li>• e. g. for art. 659905/659985/6, ...</li> <li>• in PE bag with sheet (see page 29)</li> </ul>	UVP 6,90 €

anlen

M-WAVE



ART.-NR. 	BESCHREIBUNG	DESCRIPTION	
<b>659935</b> 4	<b>FREESTYLE ROLLER</b> <ul style="list-style-type: none"> <li>• besonders <b>stabiler, fest verschweißter Aluminiumrahmen</b></li> <li>• für <b>erhöhte Stabilität</b> nicht faltbar, nicht höhenverstellbar, <b>3-fach Klemmung</b></li> <li>• <b>verstärkter Lenker</b></li> <li>• <b>100 mm</b> Laufräder mit <b>ABEC-9 Industriekugellagern</b> (Art. 659965)</li> <li>• zugelassen bis <b>100 kg</b> Fahrergewicht</li> <li>• ohne Lenkeinschlagsbegrenzung</li> <li>• mattschwarz</li> <li>• im Einzelkarton</li> </ul>	<b>FREESTYLE SCOOTER</b> <ul style="list-style-type: none"> <li>• very <b>robust, integrally welded aluminium</b> frame</li> <li>• not foldable, not height adjustable, <b>triple clamping</b> for <b>higher stability</b></li> <li>• <b>reinforced handlebar</b></li> <li>• <b>100 mm</b> wheels with <b>ABEC-9 sealed bearings</b> (art. 659965)</li> <li>• maximum rider weight <b>100 kg</b></li> <li>• no steering angle limitation</li> <li>• matt black</li> <li>• in box</li> </ul> <p style="text-align: right;">UVP 121,00 €</p>	 <p>Tested by the manufacturer based on EN 14619</p>
<b>659939</b> 2	<b>ROLLER ›200‹</b> <ul style="list-style-type: none"> <li>• <b>Aluminium</b></li> <li>• einfach <b>faltbar</b> durch Schnellverschluss</li> <li>• Lenker <b>höhenverstellbar</b> (mit <b>Sicherungsknopf</b> und <b>Verdrehschutz</b>)</li> <li>• mit Fußbremse</li> <li>• <b>200 mm</b> Laufräder mit <b>ABEC-5 Industriekugellagern</b> (Art. 659964)</li> <li>• zugelassen bis <b>100 kg</b> Fahrergewicht</li> <li>• mit <b>Lenkeinschlagsbegrenzung</b> für erhöhte Sicherheit</li> <li>• inkl. <b>Ständer</b></li> <li>• im Einzelkarton</li> </ul>	<b>SCOOTER ›200‹</b> <ul style="list-style-type: none"> <li>• <b>aluminium</b></li> <li>• easily <b>foldable</b> by QR</li> <li>• handlebar <b>height adjustable</b> (with <b>safety screw</b> and <b>screw up protector</b>)</li> <li>• with foot brake</li> <li>• <b>200 mm</b> wheels with <b>ABEC-5 sealed bearings</b> (art. 659964)</li> <li>• maximum rider weight <b>100 kg</b></li> <li>• with <b>steering angle limitation</b> for higher safety</li> <li>• incl. <b>stand</b></li> <li>• in box</li> </ul> <p style="text-align: right;">UVP 119,00 €</p>	 <p>Tested by the manufacturer based on EN 14619</p>
<b>659933</b> 6	<b>MINI-ROLLER ›120‹</b> <ul style="list-style-type: none"> <li>• <b>Aluminium</b></li> <li>• einfach <b>faltbar</b> durch Schnellverschluss</li> <li>• Lenker <b>höhenverstellbar</b> (mit <b>Sicherungsknopf</b>)</li> <li>• mit Fußbremse</li> <li>• <b>120 mm</b> Laufräder mit <b>ABEC-5 Industriekugellagern</b> (Art. 659963)</li> <li>• mit <b>Lenkeinschlagsbegrenzung</b> für erhöhte Sicherheit</li> <li>• im Einzelkarton</li> </ul>	<b>MINI SCOOTER ›120‹</b> <ul style="list-style-type: none"> <li>• <b>aluminium</b></li> <li>• easily <b>foldable</b> by QR</li> <li>• handlebar <b>height adjustable</b> (with <b>safety screw</b>)</li> <li>• with foot brake</li> <li>• <b>120 mm</b> wheels with <b>ABEC-5 sealed bearings</b> (art. 659963)</li> <li>• with <b>steering angle limitation</b> for higher safety</li> <li>• in box</li> </ul> <p style="text-align: right;">UVP 66,90 €</p>	 <p>Tested by the manufacturer based on EN 71</p>
<b>659964</b> 10 pair <b>659963</b> 50 pair <b>659965</b> 20 pair	<b>ERSATZROLLEN</b> <ul style="list-style-type: none"> <li>• mit <b>ABEC-5 Industriekugellagern</b></li> <li>• paarweise im Polybeutel</li> </ul> <p>200 mm, für Art. 659939, ...</p> <p>120 mm, für Art. 659933, ...</p> <p>100 mm, für Art. 659935, ... mit <b>ABEC-9 Industriekugellagern</b></p>	<b>REPLACEMENT ROLLS</b> <ul style="list-style-type: none"> <li>• with <b>ABEC-5 sealed bearings</b></li> <li>• one pair in PE bag</li> </ul> <p>200 mm, for art. 659939, ... UVP 29,90 €</p> <p>120 mm, for art. 659933, ... UVP 10,90 €</p> <p>100 mm, for art. 659935, ... UVP 19,90 € with <b>ABEC-9 sealed bearings</b></p>	
<b>122819</b> 50	<b>ROLLER-LENKERTASCHE ›UTRECHT TRAVEL ECO‹</b> <ul style="list-style-type: none"> <li>• Befestigung mit zwei <b>universell versetzbaren</b> Klettverschlüssen am Lenker</li> <li>• innen mit zusätzlicher Versteifung</li> <li>• mit <b>Reflexaufdruck</b></li> <li>• Größe ca. 22 x 10 x 16 cm (L x B x H)</li> <li>• mit M-Wave Anhänger</li> </ul>	<b>SCOOTER HANDLEBAR BAG ›UTRECHT TRAVEL ECO‹</b> <ul style="list-style-type: none"> <li>• mounting with two <b>universally displaceable</b> hook and loop fasteners on the handlebar</li> <li>• additional internal stiffness</li> <li>• with <b>reflective print</b></li> <li>• size approx. 22 x 10 x 16 cm (L x W x H)</li> <li>• with M-Wave tag</li> </ul> <p style="text-align: right;">UVP 9,90 €</p>	



# KINDER-LERNLAUFRÄDER CHILDREN RUNNING BIKES

ART.-NR. 	BESCHREIBUNG	DESCRIPTION	
	<p><b>HOLZ-KINDER-LERNLAUFRÄDER</b></p> <ul style="list-style-type: none"> <li>• stabiler <b>Multiplex-Holzrahmen</b></li> <li>• <b>12" Laufräder</b></li> <li>• mit <b>Industriekugellager</b></li> <li>• mit <b>Pannenschutzbereifung</b></li> <li>• <b>Sattel höhenverstellbar</b></li> <li>• Griffe mit <b>Prallschutz</b></li> <li>• mit <b>Lenkeinschlagsbegrenzung</b></li> <li>• im Einzelkarton</li> </ul>	<p><b>WOODEN CHILDREN BALANCE/ RUNNING BIKES</b></p> <ul style="list-style-type: none"> <li>• stable <b>multiplex wooden frame</b></li> <li>• <b>12" wheelsets</b></li> <li>• with <b>sealed bearings</b></li> <li>• with <b>puncture protection tires</b></li> <li>• <b>saddle height adjustable</b></li> <li>• grips with <b>impact protection</b></li> <li>• with <b>steering angle limitation</b></li> <li>• in box</li> </ul>	
659971	<p>›Motorbike‹</p> <ul style="list-style-type: none"> <li>• natur / blau</li> </ul> <p>(Ersatzrad Art. 659900)</p>	<p>›Motorbike‹</p> <ul style="list-style-type: none"> <li>• nature / blue</li> </ul> <p>(replacement wheel art. 659900)</p>	
659970	<p>›Scooter‹</p> <ul style="list-style-type: none"> <li>• rosa / pink</li> <li>• 10" Laufräder (Luftbereifung)</li> </ul> <p>(Ersatzrad mit Reifen Art. 659968)</p>	<p>›Scooter‹</p> <ul style="list-style-type: none"> <li>• rose /pink</li> <li>• 10" wheelsets (pneumatic tires)</li> </ul> <p>(replacement wheel with tire art. 659968)</p>	
659978 1	<p>›Police‹</p> <ul style="list-style-type: none"> <li>• natur / blau</li> </ul> <p>(Ersatzrad Art. 659900)</p>	<p>›Police‹</p> <ul style="list-style-type: none"> <li>• nature / blue</li> </ul> <p>(replacement wheel art. 659900)</p>	
		UVP 94,90 €	
	<p><b>HOLZ-KINDER-LERNLAUFRÄDER ›LIGHT‹</b></p> <ul style="list-style-type: none"> <li>• stabiler <b>Multiplex-Holzrahmen</b> mit ergonomischen <b>Tragegriff</b></li> <li>• nur <b>2.180 g</b></li> <li>• <b>12" Laufräder</b></li> <li>• mit <b>Industriekugellager</b></li> <li>• mit <b>Pannenschutzbereifung</b></li> <li>• <b>Sattel höhenverstellbar</b></li> <li>• Griffe mit <b>Prallschutz</b></li> <li>• mit <b>Lenkeinschlagsbegrenzung</b></li> <li>• im Einzelkarton</li> </ul>	<p><b>WOODEN CHILDREN BALANCE/ RUNNING BIKES ›LIGHT‹</b></p> <ul style="list-style-type: none"> <li>• stable <b>multiplex wooden frame</b> with ergonomic <b>handle</b></li> <li>• only <b>2,180 g</b></li> <li>• <b>12" wheelsets</b></li> <li>• with <b>sealed bearings</b></li> <li>• with <b>puncture protection tires</b></li> <li>• <b>saddle height adjustable</b></li> <li>• grips with <b>impact protection</b></li> <li>• with <b>steering angle limitation</b></li> <li>• in box</li> </ul>	
659838	natur / schwarz	nature / black	
659839 1	natur / pink	nature / pink	
		UVP 93,90 €	

ART.-NR. 	BESCHREIBUNG	DESCRIPTION	
<b>650086</b> 10	<b>HALTE-/SCHIEBESTANGE</b> <ul style="list-style-type: none"> <li>für Dreiräder oder Kinderfahrräder</li> <li>auch als <b>Radfahr-Lernhilfe</b> geeignet</li> <li>mit <b>2 Schnellspannern</b></li> </ul>	<b>CHILDREN PUSHING ROD</b> <ul style="list-style-type: none"> <li>for tricycles or children bicycles</li> <li>also useable to <b>learn cycling</b></li> <li>with <b>2 QRs</b></li> </ul>	
<b>650084</b> 20	<b>HALTE-/SCHIEBESTANGE</b> <ul style="list-style-type: none"> <li>Modell Basic</li> <li>mit Klemme für Ø 22,2 - 32 mm</li> <li>mit <b>Schnellspanner</b></li> </ul>	<b>CHILDREN PUSHING ROD</b> <ul style="list-style-type: none"> <li>model Basic</li> <li>with clamp for Ø 22.2 - 32 mm</li> <li>with <b>QR</b></li> </ul>	
<b>659811</b> 25	<b>PROTEKTOREN-SET</b> <ul style="list-style-type: none"> <li>Größe M (Jugend)</li> <li>für Fahrrad, BMX, Inliner, Skateboard, ...</li> <li><b>1 Set</b> = je 2 x Ellbogenschützer, Knieschützer und Handgelenkschützer</li> <li>Netzverpackung mit Eurolochkarte</li> </ul>	<b>PROTECTOR SET</b> <ul style="list-style-type: none"> <li>size M (youth)</li> <li>for bicycle, BMX, skates, skateboard, ....</li> <li><b>1 set</b> = 2 x elbow protectors, 2 x knee-protectors and 2 x wrist protectors</li> <li>net packing with eurohole card</li> </ul>	
	<b>ZUBEHÖRSET FÜR KINDER</b> <b>Korb</b> <ul style="list-style-type: none"> <li>aus Kunststoff</li> <li>ca. 20 x 14 x 13 cm</li> <li>universelle Befestigung mit Kunststoffbändern am Lenker, Gepäckträger, ...</li> </ul> <b>Glocke</b> <ul style="list-style-type: none"> <li>Stahl</li> <li>mit 3D-Motiv</li> <li>Kunststoffunterteil mit 2 Schrauben</li> </ul> <b>Trinkflasche</b> <ul style="list-style-type: none"> <li>300 ml</li> <li>mit Staubschutzkappe</li> <li><b>inkl. Flaschenhalter</b></li> </ul> <p>auf Ventura Kids Eurolochkarte</p>	<b>ACCESSORY KIT FOR CHILDREN</b> <b>Basket</b> <ul style="list-style-type: none"> <li>made of plastic</li> <li>approx. 20 x 14 x 13 cm</li> <li>universal mounting with plastic straps on handlebar, carrier, ...</li> </ul> <b>Bell</b> <ul style="list-style-type: none"> <li>steel</li> <li>with 3D picture</li> <li>plastic base with 2 screws</li> </ul> <b>Water bottle</b> <ul style="list-style-type: none"> <li>300 ml</li> <li>with protection cap</li> <li><b>incl. bottle cage</b></li> </ul> <p>on Ventura Kids eurohole card</p>	    
<b>650040</b>	<b>›Horse‹</b> bestehend aus Korb (Art. 431556), Glocke (Art. 420197) und Trinkflasche (Art. 340212)	<b>›Horse‹</b> consisting of basket (art. 431556), bell (art. 420197) and water bottle (art. 340212)	
<b>650041</b>	<b>›Soccer‹</b> bestehend aus Korb (Art. 431549), Glocke (Art. 420198) und Trinkflasche (Art. 340213)	<b>›Soccer‹</b> consisting of basket (art. 431549), bell (art. 420198) and water bottle (art. 340213)	
<b>650042</b> 30 set	<b>›Smile‹</b> bestehend aus Korb (Art. 431551), Glocke (Art. 420199) und Trinkflasche (Art. 340214)	<b>›Smile‹</b> consisting of basket (art. 431551), bell (art. 420199) and water bottle (art. 340214)	





UVP 19,90 €

UVP 12,90 €





Tested by the manufacturer based on ISO EN 14120

UVP 15,90 €

UVP 10,90 €

ART.-NR. 	BESCHREIBUNG	DESCRIPTION	
<p><b>659310</b></p> <p><b>659311</b></p> <p>1</p>	<p><b>EINRAD 16"</b></p> <ul style="list-style-type: none"> <li>• Aluminiumfelge</li> <li>• <b>Industriekugellager</b></li> <li>• Sattelhöhe leicht verstellbar durch Schnellspanner</li> <li>• im Einzelkarton</li> </ul> <p>silber</p> <p>rot</p>	<p><b>UNICYCLE 16"</b></p> <ul style="list-style-type: none"> <li>• <b>aluminium rim</b></li> <li>• <b>sealed bearings</b></li> <li>• saddle height easily adjustable by quick release</li> <li>• in box</li> </ul> <p>silver</p> <p>red</p> <p>UVP 135,00 €</p>	
<p><b>659321</b></p> <p><b>659322</b></p> <p><b>659323</b></p> <p><b>659324</b></p> <p><b>659325</b></p> <p>1</p>	<p><b>EINRAD 20"</b></p> <ul style="list-style-type: none"> <li>• Aluminiumfelge</li> <li>• <b>Industriekugellager</b></li> <li>• Sattelhöhe leicht verstellbar durch Schnellspanner</li> <li>• im Einzelkarton</li> </ul> <p>silber</p> <p>mattschwarz</p> <p>blau</p> <p>rot</p> <p>gelb</p>	<p><b>UNICYCLE 20"</b></p> <ul style="list-style-type: none"> <li>• <b>aluminium rim</b></li> <li>• <b>sealed bearings</b></li> <li>• saddle height easily adjustable by quick release</li> <li>• in box</li> </ul> <p>silver</p> <p>matt black</p> <p>blue</p> <p>red</p> <p>yellow</p> <p>UVP 139,00 €</p>	
<p><b>659340</b></p> <p>1</p>	<p><b>EINRAD 24"</b></p> <ul style="list-style-type: none"> <li>• Aluminiumfelge</li> <li>• <b>Industriekugellager</b></li> <li>• Sattelhöhe leicht verstellbar durch Schnellspanner</li> <li>• silber</li> <li>• im Einzelkarton</li> </ul>	<p><b>UNICYCLE 24"</b></p> <ul style="list-style-type: none"> <li>• <b>aluminium rim</b></li> <li>• <b>sealed bearings</b></li> <li>• saddle height easily adjustable by quick release</li> <li>• silver</li> <li>• in box</li> </ul> <p>UVP 179,00 €</p>	
<p><b>659095</b></p> <p>1</p>	<p><b>HOCH-EINRAD 20"</b></p> <ul style="list-style-type: none"> <li>• <b>verchromt</b></li> <li>• mit Stahlfelge</li> <li>• Sattelhöhe leicht verstellbar durch Schnellspanner</li> </ul>	<p><b>HIGH UNICYCLE 20"</b></p> <ul style="list-style-type: none"> <li>• <b>c. p.</b></li> <li>• with steel rim</li> <li>• saddle height easily adjustable by quick release</li> </ul> <p>UVP 265,00 €</p>	

# EINRÄDER ERSATZTEILE UNICYCLE REPLACEMENT PARTS

ART.-NR. 	BESCHREIBUNG	DESCRIPTION	
	<b>ERSATZTEILE</b>	<b>REPLACEMENT PARTS</b>	
<b>659302</b> 12	<b>Sattel</b> für Einrad, schwarz	<b>saddle</b> for unicycle, black	UVP 21,90 € 
<b>659309</b>	<b>Sattelstütze</b> für Einrad, verchromt 300 x 22,2 mm, für Art. 659095, ...	<b>seat post</b> for unicycle, c. p. 300 x 22.2 mm, for art. 659095, ...	
<b>659308</b> 30	300 x 25,4 mm, für 16", 20", 24", ...	300 x 25.4 mm, for 16", 20", 24", ...	UVP 8,90 € 
<b>659018</b> 50 set	<b>Abriebschutz für Einradsattel</b> • schwarz • 1 Paar (V+H) im Polybeutel • für Art. 659310/11/21/22/23/24/25/40, 659095, ...	<b>protection for unicycle saddle</b> • black • 1 pair (F+R) in a PE bag • for art. 659310/11/21/22/23/24/25/40, 659095, ...	UVP 2,90 €
<b>430224</b> 40	<b>AUSSTELLUNGSSTÄNDER</b> • universell passend für alle gängigen Größen • schwarz • im Polybeutel	<b>DISPLAY STAND</b> • universally suitable for all usual sizes • black • in PE bag	UVP 8,90 € 



**M-WAVE**

**YOUR WORLD OF CYCLING**



[www.m-wave-bike.com](http://www.m-wave-bike.com)





# FRAMES

# CARBON RENNRAHMEN CARBON ROAD FRAMES

- on request we supply your **individualised specification**, like 3 K or 12 K carbon layers. Please contact our sales staff.
- on demand we provide frames and forks in your **desired colours** with liquid coating and with your **personal decals**

ART.-NR.	BESCHREIBUNG	DESCRIPTION
----------	--------------	-------------



## RENNRADRAHMEN 700 C ›FLAT‹

- UD-Carbon, unlackiert
- für Flatmount Scheibenbremse
- integrierte Kabelführung
- Di2-ready
- Einbaumaß 142 mm
- für integrierten Steuersatz 1,5" (z. B. Art. 390215)
- mit Aluminium-Ausfallende
- Sitzrohr Ø 34,9 mm (für Sattelstütze Ø 31,6 mm)
- für Pressfit-Innenlager BB-86 41 x 86,5 mm
- nur **970 g** (Größe: 50 cm), gleichzeitig hohe Steifigkeit und Haltbarkeit
- gemäß ISO 4210-2014

RH (Mitte – Oberkante Sitzrohr)

<b>661517</b>	50 cm
<b>661518</b>	52 cm
<b>661519</b>	54 cm
<b>661520</b>	56 cm
<b>661521</b>	58 cm
<b>661522</b>	61 cm

2

## ROAD FRAME 700 C ›FLAT‹

- UD Carbon, unpainted
- for flatmount disc brake
- integrated cable routing
- Di2-ready
- OLD 142 mm
- for integrated head set 1.5" (e. g. art. 390215)
- aluminium dropout
- seat tube Ø 34.9 mm (for seat pillar Ø 31.6 mm)
- pressfit bottom bracket BB-86 41 x 86.5 mm
- only **970 g** (size: 50 cm), at the same time high stiffness and durability
- according to ISO 4210-2014

sizes: (centre - top of seat tube)

50 cm
52 cm
54 cm
56 cm
58 cm
61 cm

UVP 799,00 €

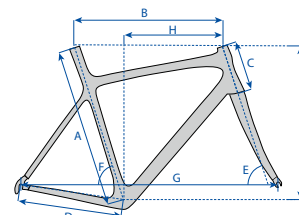

art.	661517	661518	661519	661520	661521	661522
A	500	520	540	560	580	610
B	506,3	532,1	544,8	560	579,8	590
C	130	150	160	170	180	200
D	410	410	410	410	410	410
E	70,8	71,5	72	73	72,5	72,5
F	73,8	73,5	73	73	73	73
G	975,1	982,1	985	990,6	1015,4	1025,8
H	364,4	370,6	374,6	385,4	403,3	407,7
J	525,9	545,4	556,7	571,2	577,1	596,2

## 321096

50

- passende Steckachse 12 mm
- M12 x P1,5 x T10,0 x L166 mm

- suitable thru axle 12 mm
- M12 x P1.5 x T10.0 x L166 mm

UVP 34,90 €



## 391572

20

### RENNRADGABEL ›CAR 1 1/8"-1,5" FLAT IN‹

- passende Gabel mit interner Zugverlegung
- weitere Informationen auf Seite 364

### ROAD FORK ›CAR 1 1/8"-1.5" FLAT IN‹

- suitable fork with internal cable routing
- more information on page 364

UVP 189,00 €



## 390215

100

### INTEGRIERTER STEUERSATZ 1,5"

- passender Steuersatz für interne Zugverlegung
- weitere Informationen auf Seite 348

### INTEGRATED HEAD SET 1.5"

- suitable head set for internal cable routing
- more information on page 348

UVP 39,90 €



# CARBON MTB RAHMEN CARBON MTB FRAMES

ART.-NR. BESCHREIBUNG

DESCRIPTION



NEW

## CARBON MTB RAHMEN 29"

- aus **UD Carbon**, roh
- für integrierten Steuersatz mit 1 1/8" oben und 1,5" unten
- **integrierte Kabelführung**
- mit UDH Ausfallende
- Sitzrohr für **Ø 31,6 mm Sattelstütze**
- passend für **12 x 148 Steckachse, Boost Standard**
- für BSA Innenlager

**661250** 15"  
**661251** 17"  
**661252** 19"  
**661253** 21"

2

## CARBON MTB FRAME 29"

- made of **UD Carbon**, raw finish
- for integrated head set with 1 1/8" upper and 1.5" lower
- **internal cable routing**
- with UDH dropout
- seat tube for **Ø 31.6 mm seat pillar**
- suitable for **12 x 148 thru axle, boost standard**
- for BSA B.B. set

15"  
17"  
19"  
21"

UVP 829,00 €



1097g

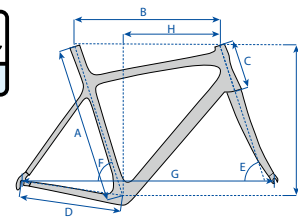

art.	661250	661251	661252	661253
A	381	431,8	482,6	533,4
B	565,5	584	605	630
C	95	100	110	120
D	440	440	440	440
E	70,5	71	71,5	71,5
F	73,5	73	73	73
G	1.060	1.070,5	1.086,3	1.111,6
H	383	396,4	413,9	453,9
J	546,8	553,6	565,1	574,6

NEW

## 321137 STECKACHSE ›QR264 SHI‹

100

- **Einbaumaß 148 mm**
- mit Schnellspanner
- M12 x Länge **173 mm**
- Gewindesteigung 1,0 mm
- Gewindelänge 14 mm
- Montageverpackung

## THRU AXLE ›QR264 SHI‹

- **OLD 148 mm**
- with QR
- M12 x length **173 mm**
- thread pitch: 1.0 mm
- thread length: 14 mm
- OEM

UVP 31,90 €





# CARBON MTB RAHMEN CARBON MTB FRAMES

ART.-NR.	BESCHREIBUNG	DESCRIPTION
----------	--------------	-------------

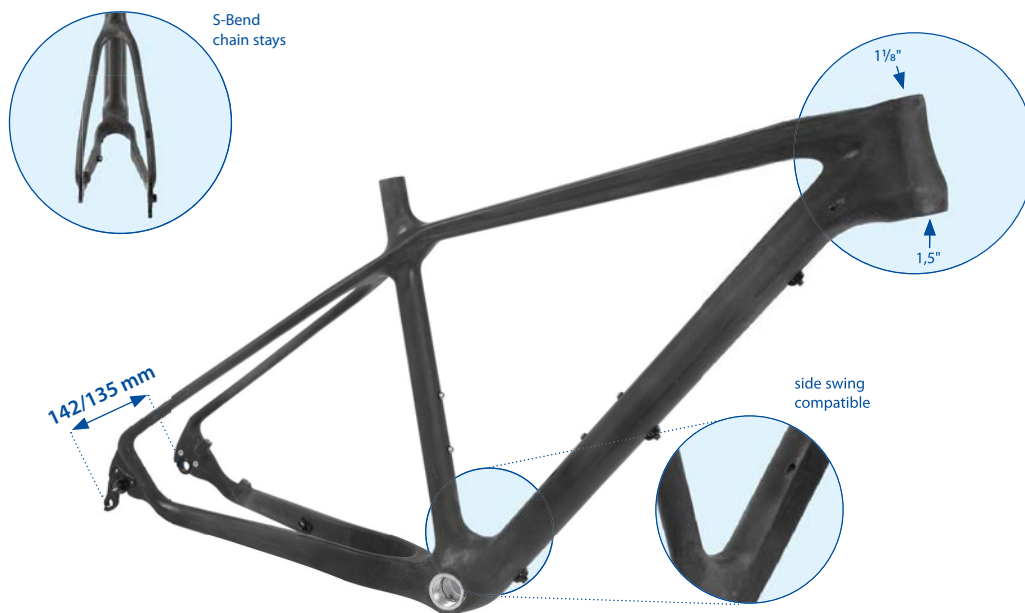

MTB RAHMEN >2 IN 1<		MTB FRAME >2 IN 1<	
	<ul style="list-style-type: none"> <li>aus <b>UD Carbon</b>, unlackiert</li> <li>für integrierten Steuersatz mit 1 1/8" oben und 1,5" unten</li> <li>Steuersatzrohr Ø 41,8 mm oben / 52,0 mm unten (innen)</li> <li>CNC-gefrästes Aluminium-Ausfallende, austauschbar (Art. 661959)</li> <li><b>side swing FD kompatibel</b></li> <li>Scheibenbremsaufnahme Postmount</li> <li><b>integrierte Kabelführung</b></li> <li>Sitzrohr Ø 31,8 mm (für Sattelstütze Ø 27,2 mm)</li> <li>passend für <b>X12, 142 mm Einbaumaß</b>, mit Art. 660038 auf <b>135 mm umbaubar</b></li> <li>für BSA-Innenlager</li> <li>max. Reifenbreite 60 mm</li> </ul>	<ul style="list-style-type: none"> <li>made of <b>UD Carbon</b>, unpainted</li> <li>for integrated head set with 1 1/8" upper and 1.5" lower</li> <li>steerer tube Ø 41.8 mm top / 52.0 mm down (inside)</li> <li>CNC machined, exchangeable aluminium dropout (art. 661959)</li> <li><b>side swing FD compatible</b></li> <li>with disc brake mounts for Postmount</li> <li><b>integrated cable routing</b></li> <li>seat tube Ø 31.8 mm (for seat pillar Ø 27.2 mm)</li> <li>suitable for <b>X12, 142 mm dimension, convertible to 135 mm</b> with art. 660038</li> <li>for BSA B.B. set</li> <li>max. tire width 60 mm</li> </ul>	
	<b>MTB RAHMEN 29"</b>	<b>MTB FRAME 29"</b>	
<b>661954</b>	17"	17"	
<b>661956</b>	21"	21"	
			UVP 869,00 €
	<b>MTB RAHMEN 27,5"</b>	<b>MTB FRAME 27.5"</b>	
<b>661941</b>	17"	17"	
<b>661943</b>	21"	21"	
			UVP 869,00 €
<b>661959</b>	Ersatz-Ausfallende	replacement dropout stop	UVP 19,90 €
<b>660038</b>	Adapter-Ausfallende für Ø 5 mm QR, Einbaumaß 135 mm	adapter dropout stop for Ø 5 mm QR, dimension 135 mm	UVP 11,90 €

## 29"

art.	661954	661956
A	432	533
B	584	630
C	100	120
D	440	440
E	71	71,5
F	73	73
G	1070,5	1111,6
H	396,4	435,9
J	553,6	574,6

## 27,5"

art.	661941	661943
A	432	533
B	585,1	615
C	110	140
D	430	430
E	70,5	71
F	73	72,5
G	1068,7	1088,5
H	402,6	417,3
J	546,5	576,9





# ALUMINIUM GRAVEL RAHMEN ALUMINIUM GRAVEL FRAME

ART.-NR. BESCHREIBUNG

DESCRIPTION



## GRAVEL RAHMEN

- Aluminiumrahmen, roh
- für **Flatmount Scheibenbremsen**
- **Einbaumaß 142 mm**
- für **12 mm Steckachse**
- für semiintegrierten Steuersatz für 1 1/8" oben und 1,5" unten
- Sitzrohr Ø 31,8 mm (für Sattelstütze Ø 27,2 mm)
- innenliegende Kabelführung
- Reifendurchlaufbreite: 58 mm
- austauschbares Ausfallende (Art. 660103)
- mit Ösen für Gepäckträger
- für BSA-Innenlager

**666141** XS (empfohlene Laufräder 27,5")

**666142** S (empfohlene Laufräder 27,5")

**666143** M

**666144** L

**666145** XL

4

## GRAVEL FRAME

- aluminium frame, raw
- for **flatmount disc brake**
- **OLD 142 mm**
- for **12 mm thru axle**
- for semiintegrated head set with 1 1/8" upper and 1.5" lower
- seat tube Ø 31.8 mm (for seat pillar Ø 27.2 mm)
- inner cable routing
- narrowest section: 58 mm
- exchangeable dropout (art. 660103)
- with eyelets for carrier
- for BSA B.B. set

XS (recommended wheel sets 27.5")

S (recommended wheel sets 27.5")

M

L

XL

UVP 249,00 €

29"

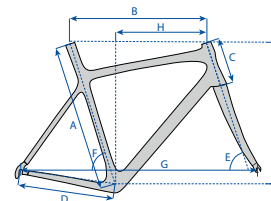

art.	666141	666142	666143	666144	666145
A	460	500	540	580	600
B	540	550	560	570	575
C	140	150	160	170	175
D	440	440	440	440	440
E	72	72	72	72	72
F	73,5	73,5	73,5	73,5	73,5
G	1020,9	1031,1	1041,5	1051,6	1056,8
H	371,3	378,5	385,7	392,9	396,5
J	569,4	579	588,5	598	602,7

**321138** passende Steckachse

suitable thru axle

UVP 36,90 €



**392687** GRAVEL GABEL 28" / 27.5"/650 B

25

- **Voll-Carbon UD**, roh
- **innere Zugverlegung**
- mit **Scheibenbremsaufnahme** (Flatmount)
- **oben 1 1/8", unten 1,5"**
- 300 mm Carbon-Ahead-Schaftrohr
- Steuersatzauflage-Ø 56 mm
- Reifendurchlaufbreite max. ca. 69,8 mm
- Einbauhöhe 406 mm
- Einbaumaß 100 mm
- für **12 mm** Steckachse
- seitliche Ösen zur Schutzblechmontage
- nur **487 g**
- passend für (Gravel-) Rahmen, z. B. Art. 666141, ...
- Montageverpackung

**GRAVEL FORK 28" /27.5"/650 B**

- **full carbon UD**, raw
- **internal cable routing**
- with **disc brake mount** (Flatmount)
- **above 1 1/8", down 1.5"**
- 300 mm carbon Ahead steerer
- bearing area Ø 56 mm
- narrowest section max. approx. 69.8 mm
- installation height 406 mm
- OLD 100 mm
- for **12 mm** thru axle
- lateral eyelets for mudguard mounting
- only **487 g**
- suitable for (Gravel-) frame, e. g. art. 666141, ...
- OEM

UVP 189,00 €

FULL CARBON



# ALUMINIUM MTB RAHMEN ALUMINIUM MTB FRAME

ART.-NR.

BESCHREIBUNG

DESCRIPTION



S-Bend  
chain stays  
+ Muscle  
Shape

## ALUMINIUM MTB RAHMEN 29"

- **Hydroform** Design
- Sitz-, Ober- und Unterrohr **2-fach konifiziert**
- für semi integrierten Steuersatz für **1 1/8" oben und 1,5" unten** (z. B. Art. 390378)
- für Scheibenbremsaufnahme Postmount
- **S-bend** Sitzrohrstreben
- **verstärktes Ober- und Unterrohr**
- **austauschbares Ausfallende** rechts (Art. 660852)
- Sitzrohr Ø 34,9 mm (für Sattelstütze Ø 31,6 mm)
- Steuersatzrohr Ø 44,0 mm (innen, für 1 1/8" Oversize semi integrierten Steuersatz)
- max. Reifenbreite 70 mm

## ALUMINIUM MTB FRAME 29"

- **Hydroform** design
- **double butted** seat, top and down tube
- for semi integrated head set with **1 1/8" upper and 1.5" lower** (e.g. art. 390378)
- with disc brake mounts Postmount
- **S-bend** seat stays
- **gusset at top and down tube**
- **exchangeable dropout** right (art. 660852)
- seat tube Ø 34.9 mm (for seat pillar Ø 31.6 mm)
- head tube Ø 44.0 mm (inner, for 1 1/8" oversize semi integrated head set)
- max. tire width 70 mm

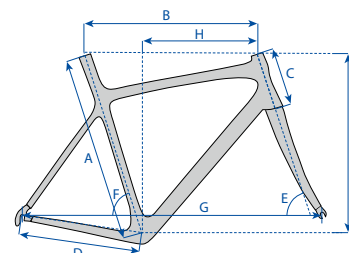

29"

	schwarz lackiert/ black coated	roh/ raw
43 cm	<b>660059</b> AD	<b>660092</b>
48 cm	<b>660060</b> AD	<b>660093</b>
54 cm	<b>660061</b> AD	<b>660094</b>
	UVP 213,00 € UVP mAD 305,00 €	UVP 213,00 €

art.	660059	660060	660061
art.	660092	660093	660094
size	43	48	54
A	432	483	546
B	596	615,1	638,2
C	110	110	110
D	450	450	450
E	70	70	70
F	73	73	73
G	1096,2	1115,3	1138,4
H	408,8	427,9	451
J	612,3	612,3	612,3

	schwarz lackiert/ black coated	roh/ raw
43 cm	<b>660055</b> AD	<b>660067</b>
48 cm	<b>660056</b> AD	<b>660068</b>
54 cm	<b>660057</b> AD	<b>660069</b>
2	UVP 213,00 € UVP mAD 305,00 €	UVP 213,00 €

27,5"/650B

art.	660055	660056	660057
art.	660067	660068	660069
size	43	48	54
A	432	483	546
B	576,8	586,8	604,9
C	110	110	110
D	440	440	440
E	70	70	70
F	73	73	73
G	1081,1	1091,1	1109,2
H	398,2	408,2	426,2
J	584,4	584,4	584,4

# ALUMINIUM MTB/TREKKING RAHMEN

## ALUMINIUM MTB/TREKKING FRAME

ART.-NR. BESCHREIBUNG

DESCRIPTION



### 660744 ALUMINIUM MTB RAHMEN 26"

AD  
2

- 23,5"
- **S-bend** Sitzrohrstreben
- **verstärktes Unterrohr**
- **austauschbares Ausfallende** rechts und Anlötteile für Scheibenbremse IS links
- mit Ösen für Gepäckträger
- mattschwarz
- Sitzrohr Ø 31,8 mm (für Sattelstütze Ø 27,2 mm)
- Oberrohr Tropfenform
- Unterrohr Tropfenform (ovalisiert)
- Steuersatzrohr Ø 44,0 mm (innen, für 1 1/8" Oversize semiintegriertem Steuersatz)
- max. Reifenbreite 68 mm

### ALUMINIUM MTB FRAME 26"

- 23,5"
- **S-bend** seat stays
- **gusset at down tube**
- **exchangeable drop out** right and eyelets for disc brake IS left
- with eyelets for carrier
- matt black
- seat tube Ø 31.8 mm (for seat pillar Ø 27.2 mm)
- top tube drop type
- down tube drop type (ovalised)
- head tube Ø 44.0 mm (inner, for 1 1/8" oversize semi integrated headset)
- max. tire width 68 mm

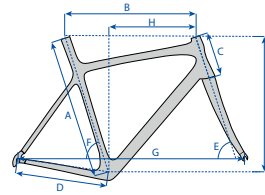

26"

size	23,5"
A	597
B	603,2
C	160
D	425
E	71
F	73
G	1083
H	428,6
J	563,4



UVP 99,90 €  
UVP mAD 139,00 €

### ALUMINIUM TREKKING RAHMEN 28"

- roh
- **S-bend** Sitzrohrstreben
- verstärktes Unterrohr
- mit **austauschbarem Ausfallende** rechts und Anlötteilen für **Scheibenbremse IS** links
- mit **Anlötplatte** für Ständermontage an der Kettenstrebene
- mit Ösen für Gepäckträger
- verkürztes Sitzrohr für gefederte Sattelstütze
- Sitzrohr Ø 31,8 mm (für Sattelstütze Ø 27,2 mm)
- Oberrohr Tropfenform
- Unterrohr Tropfenform
- Steuersatzrohr Ø 44,0 mm (innen für 1 1/8" Gabel semiintegrierten Steuersatz)
- max. Reifenbreite 65 mm

### ALUMINIUM TREKKING FRAME 28"

- raw
- **S-bend** seat stays
- with gusset at down tube
- with **exchangeable drop out** right and eyelets for **disc brake IS** left
- with **brazing plate** for stand mounting on the chain stay
- with eyelets for carrier
- shorter seat tube for suspension seat post
- seat tube Ø 31.8 mm (for seat pillar Ø 27.2 mm)
- top tube drop type
- down tube drop type
- head tube Ø 44.0 mm (inner for 1 1/8" fork semi integrated head set)
- max. tire width 65 mm

28"

art.	660311	660312	660313
A	510	540	450
B	580	585,3	590,2
C	120	120	120
D	450	450	450
E	71	71	71
F	73	73	73
G	1103,7	1103,7	1090,3
H	424,8	424,8	412,4
J	571,7	571,7	581,7



UVP 152,00 €

660311 51 cm (entspr. herköm. 54 cm)

51 cm (conventional 54 cm)

660312 54 cm (entspr. herköm. 57 cm)

54 cm (conventional 57 cm)

4

660313 wie Art. 660311/2, aber für Damen

4

- 45 cm (entspr. herköm. 48 cm)
- mit tiefem Einstieg
- Tropfenform nur beim Unterrohr
- mit Kabelführung unter dem Tretlagergehäuse
- max. Reifenbreite 66,8 mm

- like art. 660311/2, but for ladies
- 45 cm (conventional 48 cm)
- with low top tube
- drop type only on down tube
- with cable guide under B/B tube
- max. tire width 66.8 mm



UVP 189,90 €



# FEDERUNGSELEMENT REAR SHOCK

ART.-NR.	BESCHREIBUNG	DESCRIPTION	
	<p><b>FEDERUNGSELEMENT</b></p> <ul style="list-style-type: none"> <li>• Aluminium-Körper</li> <li>• schwarze Stahlfeder</li> <li>• <b>einstellbar</b></li> <li>• für Hinterbau</li> <li>• Federweg 34 mm</li> <li>• 650 lbs</li> <li>• mit Befestigungsschrauben</li> <li>• Montageverpackung</li> </ul>	<p><b>REAR SHOCK</b></p> <ul style="list-style-type: none"> <li>• aluminium body</li> <li>• black steel spring</li> <li>• <b>adjustable</b></li> <li>• for rear stay</li> <li>• travel 34 mm</li> <li>• 650 lbs</li> <li>• with fixing screws</li> <li>• OEM</li> </ul>	
660431	Einbaumaß: <b>150 mm</b> x 24/24 mm	eye to eye: <b>150 mm</b> x 24/24 mm UVP 13,90 €	
660430	Einbaumaß: <b>165 mm</b> x 24/24 mm 40	eye to eye: <b>165 mm</b> x 24/24 mm UVP 14,90 €	

INFO	INDIVIDUELLE RAHMEN	INDIVIDUAL FRAMES	
	<p>Fragen Sie uns nach speziell für Sie designten E-Bike (Mittelmotor)rahmen für <b>Shimano, Brose, Bafang, Bosch, ...</b>, Lastenrad oder sonstigen Rahmen. Auf Anfrage lassen wir die Rahmen für Sie in Ihrer <b>Wunschfarbe</b> (RAL-Farben) pulverbeschichten oder lackieren.</p>	<p>Ask us for your individually designed E-Bike (mid-engine) frame for <b>Shimano, Brose, Bafang, Bosch, ...</b>, cargo bikes or other frames. On request we can provide the frames with <b>powder coating or paint finish</b> (RAL colours).</p>	



[www.messingschlager.com/de/gravel](http://www.messingschlager.com/de/gravel)



# SCHALTAUGEN DERAILLEUR HANGER

ART.-NR.	BESCHREIBUNG	DESCRIPTION
	<p><b>SCHALTAUGEN</b> für Aluminium-Rahmen</p> <p>Sie können mit unseren Schaltaugen verschiedene Modelle der folgenden Hersteller bestücken:</p> <p>4Ever, Access, Alenax, American Eagle, Apollo, Argon 18, Author, Barracuda, Be One, Bergamont, Bevato, BH, Bianchi, Blue, Bottecchia, Brodie, Canyon, Carrera Kraken, Capriolo, Centurion, Cinelli, Colnago, Coluer, Corratec, Coyote, Claude Butler, Cube 260, Da Bomb, Dahon, Dawes, De Rosa, Diamondback, Ducati (by Bianchi), Eastern 26, Element, Evoke, Falcon, Fausto Coopi, Felt, Flow Bikes, Focus, Fuji, Gary Fisher, Ghost, Giant, GT, Gudereit, Haibike, Haro, Hasa, Head, Hercules, Hot Chili, Ibis, Ideal, Ironhorse, Isaac, Jamis, Jeep, Kalkhoff, Kawasaki, Kellys, Kettler, Klein, Kinesis, Kona, KHS, KTM, Lapierre, Lightwave, Marin, Marsstar, Maxx, Merida, Mongoose, Montague, Morewood, MSC, Muddy Fox, Müsing, Nakamura, Nakita, Norco, Orbea, Optima, Orange, Quantec, Pinarelli, Pivot, Principia, Raleigh, Red Bull, Redline, Rocky Mountain, Rose, Salsa, Salcano, Saracen, Scapin, Scott, Sette, Shogun, Spank Puff, Stevens, Storck, Strongman, Specialized, Schwinn, Simplon, Steppenwolf, Tony Hawk, Trek, Turner, Univega, Van Dessel, Vektor, Venzo, Viking, Viner, Vision, Wheeler, Wilier (Kein original Ersatzteil)</p>	<p><b>DERAILLEUR HANGER</b> for aluminium frames</p> <p>You can use our dropouts for several models of the following manufacturers:</p> <p>(no original spare part)</p>
<b>660853</b> 500/100	für Art. 660744, 660311-2, ... für Modelle von z. B. Marin, KHS, Schwinn, Stevens, Felt, ...	for art. 660744, 660311-2, ... for bikes by e. g. Marin, KHS, Schwinn, Stevens, Felt, ...
<b>660858</b> 500/100	für Modelle von z. B. Kona, Norco, Marin, Merida, Focus, ...	for bikes by e. g. Kona, Norco, Marin, Merida, Focus, ...
<b>660846</b> 200/100	für Modelle von z. B. Raleigh, Merida, Ironhorse, KHS, Ibis, ...	for bikes by e. g. Raleigh, Merida, Ironhorse, KHS, Ibis, ...
<b>660854</b> 300/100	für Modelle von z. B. Trek, Gary Fisher, Klein, Schwinn, Hot Chili, ...	for bikes by e. g. Trek, Gary Fisher, Klein, Schwinn, Hot Chili, ...
<b>660856</b> 500/100	für Modelle von z. B. Focus, Apollo, Haro, Jamis, Kellys, ...	for bikes by e. g. Focus, Apollo, Haro, Jamis, Kellys, ...
<b>660857</b> 500/100	für Modelle von z. B. Corratec, Wilier, Argon 18, Storck, Bergamont, ...	for bikes by e. g. Corratec, Wilier, Argon 18, Storck, Bergamont, ...











**ABBILDUNG**  
1 : 2









In unserem Webshop haben Sie die Möglichkeit, Schablonen der Schaltaugen in **Originalgröße** auszudrucken. So finden Sie schnell das richtige Ersatzteil!

You can also find derailleur hanger templates in **original size** to print out via our webshop. So finding the right spare part becomes pretty easy!



# SCHALTAUGEN DERAILLEUR HANGER

ART.-NR. 	BESCHREIBUNG	DESCRIPTION	
<b>660878</b> 300/100	für Modelle von Scott, ...	for bikes by Scott, ...	 UVP 9,90 €
<b>660887</b> 200/100	für Modelle von Specialized, ...	for bikes by Specialized, ...	 UVP 9,90 €
<b>660877</b> 200/100	für Modelle von z. B. GT, Bergamont, Centurion, Raleigh, Mongoose, ...	for bikes by e. g. GT, Bergamont, Centurion, Raleigh, Mongoose, ...	 UVP 9,90 €
<b>660888</b> 200/100	für Modelle von z. B. Diamondback, Raleigh, Bianchi, Merida, Focus, ...	for bikes by e. g. Diamondback, Raleigh, Bianchi, Merida, Focus, ...	 UVP 9,90 €
<b>660048</b> 200	für Modelle von z. B. Haro, Raleigh, KHS, Marin, Jamis, Schwinn, Barracuda, Claude Butler, Shogun, Falcon, ...	for bikes by e. g. Haro, Raleigh, KHS, Marin, Jamis, Schwinn, Barracuda, Claude Butler, Shogun, Falcon, ...	 UVP 9,90 €
<b>660049</b> 600/100	für Modelle von z. B. Cube 260, Diamondback, Tony Hawk, Eastern 26, Ghost, ...	for bikes by e. g. Cube 260, Diamondback, Tony Hawk, Eastern 26, Ghost, ...	 UVP 9,90 €
<b>660852</b> 400/100	<ul style="list-style-type: none"> <li>• schwarz eloxiert</li> <li>• für Art. 660055 - 660094</li> <li>• auch für KHS SixFifty 300, KHS SixFifty 600 und KHS SixFifty 603 MY13</li> </ul>	<ul style="list-style-type: none"> <li>• black anodized</li> <li>• for art. 660055 - 660094</li> <li>• also for KHS SixFifty 300, KHS SixFifty 600 and KHS SixFifty 603 MY13</li> </ul>	 UVP 9,90 €
<b>661959</b> 200	<ul style="list-style-type: none"> <li>• schwarz</li> <li>• für Art. 661941-3, 661953-6, ...</li> </ul>	<ul style="list-style-type: none"> <li>• black</li> <li>• for art. 661941-3, 661953-6, ...</li> </ul> 	 UVP 19,90 €

ART.-NR.	BESCHREIBUNG	DESCRIPTION	
<b>660199</b> 20	<ul style="list-style-type: none"> <li>• schwarz</li> <li>• für Art. 661517/18/19/20/21/22, ...</li> </ul>	<ul style="list-style-type: none"> <li>• black</li> <li>• for art. 661517/18/19/20/21/22, ...</li> </ul>	
<b>660891</b> 200	<p>In unserem Webshop haben Sie die Möglichkeit, Schablonen der Schaltaugen in <b>Originalgröße</b> auszudrucken. So finden Sie schnell das richtige Ersatzteil!</p>	<p>You can also find derailleur hanger templates in <b>original size</b> to print out via our webshop. So finding the right spare part becomes pretty easy!</p>	
<b>660892</b> 200	<p>In unserem Webshop haben Sie die Möglichkeit, Schablonen der Schaltaugen in <b>Originalgröße</b> auszudrucken. So finden Sie schnell das richtige Ersatzteil!</p>	<p>You can also find derailleur hanger templates in <b>original size</b> to print out via our webshop. So finding the right spare part becomes pretty easy!</p>	
<b>660893</b> 200	<p>In unserem Webshop haben Sie die Möglichkeit, Schablonen der Schaltaugen in <b>Originalgröße</b> auszudrucken. So finden Sie schnell das richtige Ersatzteil!</p>	<p>You can also find derailleur hanger templates in <b>original size</b> to print out via our webshop. So finding the right spare part becomes pretty easy!</p>	
<b>660894</b> 200	<p>In unserem Webshop haben Sie die Möglichkeit, Schablonen der Schaltaugen in <b>Originalgröße</b> auszudrucken. So finden Sie schnell das richtige Ersatzteil!</p>	<p>You can also find derailleur hanger templates in <b>original size</b> to print out via our webshop. So finding the right spare part becomes pretty easy!</p>	
<b>660998</b> 200	<p>In unserem Webshop haben Sie die Möglichkeit, Schablonen der Schaltaugen in <b>Originalgröße</b> auszudrucken. So finden Sie schnell das richtige Ersatzteil!</p>	<p>You can also find derailleur hanger templates in <b>original size</b> to print out via our webshop. So finding the right spare part becomes pretty easy!</p>	
<b>880500</b> 100  <b>NEW</b>  	<p><b>NOTFALL-AUSFALLENDE</b></p> <ul style="list-style-type: none"> <li>• <b>ersetzt</b> vorübergehend ein <b>abgebrochenes Schaltauge</b></li> <li>• <b>ermöglicht die Heimfahrt</b>, da einige Gänge schaltbar bleiben</li> <li>• <b>passend für die meisten Rahmen</b> und Ausfallenden</li> <li>• für gängige 9 mm Nabenachsen</li> <li>• Inklusive Kontermutter passend für 5 mm QR-Achse</li> <li>• auf SuperB Eurolochkarte</li> </ul>	<p><b>EMERGENCY HANGER</b></p> <ul style="list-style-type: none"> <li>• temporarily <b>replaces a broken derailleur hanger</b></li> <li>• <b>allows you to ride home</b> because some gears can still be shifted</li> <li>• <b>suitable for most frames</b> and dropouts</li> <li>• for standard 9 mm hub axles</li> <li>• with locknut for 5 mm QR axle</li> <li>• on SuperB eurohole card</li> </ul>	
<b>680280</b> 500	<p><b>SCHALTWERK-ADAPTER ›ADA RANGE‹</b></p> <ul style="list-style-type: none"> <li>• Aluminium</li> <li>• <b>ermöglicht die Verwendung von wide-range Kassetten</b> mit großen Ritzeln, ohne dass ein Kettenwechsel mit längerem Käfig nötig ist</li> <li>• besonders geeignet zum Umbau auf 1-fach Kettenradgarnitur</li> <li>• auf M-Wave Eurolochkarte</li> </ul>	<p><b>REAR DERAILLEUR ADAPTER ›ADA RANGE‹</b></p> <ul style="list-style-type: none"> <li>• aluminium</li> <li>• <b>allows the installation of wide-range cassettes</b> with large sprockets, without the need for a chain change with a longer cage</li> <li>• especially suitable for conversion to 1 speed chainwheel set</li> <li>• on M-Wave eurohole card</li> </ul>	



















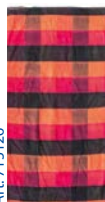



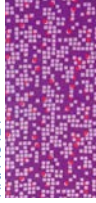









# CLOTHING





ART.-NR.	BESCHREIBUNG	DESCRIPTION	
<p></p> <p><b>ÜBERSCHUH</b></p> <ul style="list-style-type: none"> <li>aus <b>Neopren</b></li> <li>unten mit Aussparungen für Klick-Pedale</li> <li>hinten <b>leichter Einstieg</b> durch Klettverschluss</li> <li>mit <b>Reflexstreifen</b></li> <li>paarweise auf M-Wave Eurolochkarte</li> </ul> <p><b>715312</b> Größe S/M</p> <p><b>715313</b> Größe M/L</p> <p><b>715314</b> Größe L/XL</p> <p>50 pair</p>	<p><b>SHOE COVER</b></p> <ul style="list-style-type: none"> <li>made of <b>neoprene</b></li> <li>with recess below for clipless pedals</li> <li><b>easy access</b> by hook and loop fastener at the back</li> <li>with <b>reflective tape</b></li> <li>one pair on M-Wave eurohole card</li> </ul> <p>size S/M</p> <p>size M/L</p> <p>size L/XL</p> <p>UVP 21,90 €</p>		
<p><b>715311</b> 125 pair</p> <p><b>SILIKON-ÜBERSCHUH &gt;TOE SHIELD&lt;</b></p> <ul style="list-style-type: none"> <li><b>langlebiges, strapazierfähiges Silikon</b></li> <li><b>flexible, universelle</b> Passform (S-XL)</li> <li><b>schützt</b> vor Wind und Nässe</li> <li>schnell übergestülpt mit Zuglasche</li> <li><b>Verstärkung</b> im Zehen- und Laufbereich</li> <li>unten mit Aussparung für Schuhplatten</li> <li>paarweise auf M-Wave Eurolochkarte</li> </ul>	<p><b>SILICONE SHOE COVER &gt;TOE SHIELD&lt;</b></p> <ul style="list-style-type: none"> <li><b>long-lasting, durable silicone</b></li> <li><b>flexible, universal fit</b> (S-XL)</li> <li><b>protects</b> against wind and wetness</li> <li>quickly put on with strap</li> <li><b>reinforced</b> at the toe and running area</li> <li>recess below for cleats</li> <li>one pair on M-Wave eurohole card</li> </ul> <p>UVP 12,90 €</p>		
<p><b>ARMLINGE UND BEINLINGE</b></p> <ul style="list-style-type: none"> <li><b>leicht</b> und <b>klein</b></li> <li><b>trocknet</b> schnell</li> <li><b>3D-Technologie</b></li> <li>98 % anti-UV bewirkt Temperatursenkung um bis zu 3 °C</li> <li>80 % Polyamid, 20 % Spandex</li> <li>paarweise auf M-Wave Eurolochkarte</li> </ul> <p><b>Armlinge</b></p> <p><b>715324</b> Größe S/M</p> <p><b>715325</b> Größe L/XL</p> <p><b>Beinlinge</b></p> <p><b>715326</b> Größe S/M</p> <p><b>715327</b> Größe L/XL</p> <p>50 pair</p>	<p><b>ARM- AND LEGWARMERS</b></p> <ul style="list-style-type: none"> <li><b>light</b> and <b>small</b></li> <li><b>fast drying</b></li> <li><b>3D</b> technology</li> <li>98 % anti UV lowers the temperature up to 3 °C</li> <li>80 % Polyamid, 20 % Spandex</li> <li>one pair on M-Wave eurohole card</li> </ul> <p><b>Armwarmers</b></p> <p>size S/M</p> <p>size L/XL</p> <p>UVP 14,90 €</p> <p><b>Legwarmers</b></p> <p>size S/M</p> <p>size L/XL</p> <p>UVP 16,90 €</p>		
<p><b>TIP</b></p> <p><b>POLSTER-BOXERSHORTS</b></p> <ul style="list-style-type: none"> <li><b>Unterhose</b> zum Radfahren mit bi-elastischer, <b>nahtlos eingeschweißter Polsterung</b></li> <li><b>anatomischer</b> Schnitt</li> <li><b>gute Passform</b> durch <b>3D-Dehnbarkeit</b></li> <li>eingearbeitete <b>Klimazonen</b></li> <li><b>geruchsneutralisierend</b></li> <li>85% Polyamid, 15% Polyester</li> <li>im Einzelkarton</li> </ul> <p><b>715596</b> M</p> <p><b>715597</b> L</p> <p><b>715598</b> XL</p> <p>42</p>	<p><b>POLSTER-BOXERSHORTS</b></p> <ul style="list-style-type: none"> <li>cycling <b>pants</b> with bi-elastic, <b>seamlessly welded padding</b></li> <li><b>anatomic</b> cut</li> <li><b>excellent fit</b> through <b>3D-flexibility</b></li> <li>integrated <b>climate zones</b></li> <li><b>odour-neutralising</b></li> <li>85% Polyamid, 15% Polyester</li> <li>in box</li> </ul> <p>M</p> <p>L</p> <p>XL</p> <p>UVP 34,90 €</p>		

ART.-NR. 	BESCHREIBUNG	DESCRIPTION		
<b>NICE PRICE</b>	<b>HALS-/KOPFTUCH</b>	<b>TUBULAR HEADWEAR</b>		
	<ul style="list-style-type: none"> <li>• 100 % Polyester <b>Funktions-Microfaser</b></li> <li>• <b>nahtlos, elastisch</b> und <b>atmungsaktiv</b></li> <li>• Größe: ca. 24 x 48 cm</li> <li>• auf M-Wave Eurolochkarte</li> </ul>	<ul style="list-style-type: none"> <li>• 100 % Polyester <b>function microfibre</b></li> <li>• <b>seamless, elastic</b> and <b>breathable</b></li> <li>• size: approx. 24 x 48 cm</li> <li>• on M-Wave eurohole card</li> </ul>		
715179	›Camouflage‹ 	›Camouflage‹ 	 Art. 715179  Art. 715196  Art. 715197  Art. 715206  Art. 715199  Art. 715122  Art. 715116  Art. 715126  Art. 715205  Art. 715129  Art. 715128  Art. 715204  Art. 715124  Art. 715194 	
715196	›White‹ 	›White‹		
715197	›Black‹ 	›Black‹		
715206	›Neon Yellow‹ 	›Neon Yellow‹		
715199	›Skull‹ 	›Skull‹		
715122	›Stripes B/W‹ 	›Stripes B/W‹		
715116	›White & Stripes‹ 	›White & Stripes‹		
715126	›Purple Squared‹ 	›Purple Squared‹		
715205	›Circles‹ 	›Circles‹		
715129	›Red/Blue Squared‹ 	›Red/Blue Squared‹		
715128	›Blue/Red Squared‹ 	›Blue/Red Squared‹		
715204	›Squares and Bubbles‹ 	›Squares and Bubbles‹		
715124	›Purple Squared‹ 	›Purple Squared‹		
715194 150	›M-Wave‹ 	›M-Wave‹	UVP 3,90 €	
	Ab einer Stückzahl von 450 Exemplaren erstellen wir Ihnen gerne ein Angebot für Ihr individuelles Design.	At a minimum of 450 pieces we will be able to make you an offer with your individual design.		
715168 100 <b>NICE PRICE</b>	<b>HALS-/KOPFTUCH</b> ›BLACK FLEECE‹	<b>TUBULAR HEADWEAR</b> ›BLACK FLEECE‹		
	<ul style="list-style-type: none"> <li>• 100 % Polyester <b>Funktions-Microfaser</b> mit <b>Fleece-Einsatz</b></li> <li>• <b>elastisch</b> und <b>atmungsaktiv</b></li> <li>• Größe: ca. 24 x 70 cm</li> <li>• auf M-Wave Eurolochkarte</li> </ul>	<ul style="list-style-type: none"> <li>• 100 % Polyester <b>function microfibre</b> with <b>fleece application</b></li> <li>• <b>elastic</b> and <b>breathable</b></li> <li>• size: approx. 24 x 70 cm</li> <li>• on M-Wave eurohole card</li> </ul>		
			 <b>FLEECE</b> 	
			UVP 5,90 €	

ART.-NR.	BESCHREIBUNG	DESCRIPTION	
<b>715153</b> 50/10	<b>REGENUMHANG</b> <ul style="list-style-type: none"> <li>• <b>Universalgröße</b></li> <li>• schützt auch die Beine, Hände und Lenkereinheit</li> <li>• mit <b>verschießbarem</b> V-Ausschnitt</li> <li>• mit Griffschlaufen</li> <li>• mit Kordelzugkapuze</li> <li>• farbig sortiert (blau und gelb)</li> <li>• im Polybeutel mit Euroloch</li> </ul>	<b>RAIN PONCHO</b> <ul style="list-style-type: none"> <li>• <b>universal size</b></li> <li>• also protects legs, hands and handlebar unit</li> <li>• with <b>closable</b> V-neck</li> <li>• with grip straps</li> <li>• with drawstring hood</li> <li>• assorted colours (blue and yellow)</li> <li>• in PE bag with eurohole</li> </ul>	 UVP 12,90 €
<b>259891</b> 50 <b>NEW</b>	<b>KINDER-REGENPONCHO ›PONCHO KID ´N´ SEAT‹</b> <ul style="list-style-type: none"> <li>• passend für <b>alle gängigen Kindersitze</b></li> <li>• geeignet für <b>Kinder von 6 Monaten bis 5 Jahren</b></li> <li>• mit Ärmeln für optimale Bewegungsfreiheit</li> <li>• auch zur Abdeckung des Kindersitzes geeignet</li> <li>• mit reflektierenden Elementen</li> <li>• im Polybeutel mit Euroloch</li> </ul>	<b>RAIN COVER FOR CHILDREN SEAT ›PONCHO KID ´N´ SEAT‹</b> <ul style="list-style-type: none"> <li>• suitable for <b>all common child seats</b></li> <li>• suitable for <b>children from 6 months to 5 years</b></li> <li>• with sleeves for optimal freedom of movement</li> <li>• also useable for covering the baby seat</li> <li>• with reflective elements</li> <li>• in PE bag with eurohole</li> </ul>	 UVP 34,90 €
<b>719961</b> Größe M  <b>719963</b> Größe L/XL 120/5 pair	<b>FAHRRADHANDSCHUHE ›ALASKA‹</b> <ul style="list-style-type: none"> <li>• <b>Windprotector</b> außen</li> <li>• <b>wärmendes</b> Fleece innen</li> <li>• <b>Non-Slip-Noppen</b> für festen Griff</li> <li>• wasserabweisend</li> <li>• atmungsaktiv</li> <li>• mit <b>reflektierendem Material</b> von <b>3M Scotchlite</b> an den Seiten</li> <li>• mit Gummizug</li> <li>• nur 122 g (M)</li> <li>• auf M-Wave Eurolochkarte</li> </ul>	<b>BICYCLE GLOVES ›ALASKA‹</b> <ul style="list-style-type: none"> <li>• <b>windprotector</b> outside</li> <li>• <b>warming</b> fleece inside</li> <li>• <b>non-slip knobs</b> for a firm grip</li> <li>• water-repellent</li> <li>• breathable</li> <li>• with <b>reflecting material</b> of <b>3M Scotchlite</b> on the sides</li> <li>• with rubber spring</li> <li>• only 122 g (M)</li> <li>• on M-Wave eurohole card</li> </ul>	 UVP 15,90 €
<b>719862</b> 150/5 pair	<b>GEL-FAHRRADHANDSCHUHE ›PROTECT SL‹</b> <ul style="list-style-type: none"> <li>• <b>Ganzfingerhandschuh</b> mit <b>integrierten Silikon-Protectoren</b></li> <li>• <b>Geleinslagen</b> verringern den Druck auf den Ulnarnerv und den Karpaltunnel. Dies hilft gegen einschlafende Hände.</li> <li>• Daumen und Zeigefinger mit spezieller <b>Auflage</b> zur <b>Touchscreenbedienung</b></li> <li>• <b>atmungsaktiv</b> und <b>waschbar</b></li> <li>• <b>elastischer Bund</b> mit <b>hochwertigem Klettverschluss</b></li> <li>• Größe L</li> <li>• auf M-Wave Eurolochkarte</li> </ul>	<b>GEL BICYCLE GLOVES ›PROTECT SL‹</b> <ul style="list-style-type: none"> <li>• <b>full finger</b> glove with <b>integrated silicone protectors</b></li> <li>• <b>gel inlays</b> reduce pressure on the ulnar nerve and the carpal tunnel. This helps against paraesthesia in the hands.</li> <li>• thumb and forefinger with <b>contact area</b> for <b>touchscreen operation</b></li> <li>• <b>breathable</b> and <b>washable</b></li> <li>• <b>elastic waistband</b> with <b>high quality hook and loop fastener</b></li> <li>• size L</li> <li>• on M-Wave eurohole card</li> </ul>	 UVP 18,90 €

ART.-NR. 	BESCHREIBUNG	DESCRIPTION	
<p><b>719856</b> Größe S</p> <p><b>719857</b> Größe M</p> <p><b>719858</b> Größe L</p> <p><b>719859</b> Größe XL</p> <p>150/5 pair</p>	<p><b>GEL-FAHRRADHANDSCHUHE</b> ›PROTECT HD‹</p> <ul style="list-style-type: none"> <li>• <b>Ganzfingerhandschuh mit integrierten Knöchel-Protektoren</b></li> <li>• <b>Geleinlagen</b> verringern den Druck auf den Ulnarnerv und den Karpaltunnel. Dies hilft gegen einschlafende Hände.</li> <li>• Daumen und Zeigefinger mit spezieller <b>Auflage zur Touchscreenbedienung</b></li> <li>• integrierte <b>Ausziehhilfe</b> aus <b>3M Scotchlite®</b></li> <li>• <b>atmungsaktiv</b> und <b>waschbar</b></li> <li>• <b>elastischer Bund mit hochwertigem Klettverschluss</b></li> <li>• auf M-Wave Eurolochkarte</li> </ul>	<p><b>GEL BICYCLE GLOVES</b> ›PROTECT HD‹</p> <ul style="list-style-type: none"> <li>• <b>full finger</b> glove with <b>integrated knuckle protectors</b></li> <li>• <b>gel inlays</b> reduce pressure on the ulnar nerve and the carpal tunnel. This helps against paraesthesia in the hands.</li> <li>• thumb and forefinger with <b>contact area for touchscreen operation</b></li> <li>• with <b>loops as take-off assistance</b> made of <b>3M Scotchlite®</b></li> <li>• <b>breathable</b> and <b>washable</b></li> <li>• <b>elastic waistband with high quality hook and loop fastener</b></li> <li>• on M-Wave eurohole card</li> </ul>	
<p><b>719890</b> Größe S</p> <p><b>719891</b> Größe M</p> <p><b>719892</b> Größe L</p> <p><b>719893</b> Größe XL</p> <p>150/5 pair</p>	<p><b>GEL-FAHRRADHANDSCHUHE</b> ›GLOW‹</p> <ul style="list-style-type: none"> <li>• neongelbe <b>Sicherheitsfarbe</b></li> <li>• <b>Geleinlagen</b> verringern den Druck auf den Ulnarnerv und den Karpaltunnel. Dies hilft gegen einschlafende Hände.</li> <li>• mit <b>360° reflektierenden</b> Applikationen</li> <li>• Daumen und Zeigefinger mit spezieller <b>Auflage zur Touchscreenbedienung</b></li> <li>• mit <b>Ausziehhilfe</b></li> <li>• außen teilweise aus <b>elastischem Lycra</b></li> <li>• <b>atmungsaktiv</b> und <b>waschbar</b></li> <li>• <b>elastischer Bund</b></li> <li>• auf M-Wave Eurolochkarte</li> </ul>	<p><b>GEL BICYCLE GLOVES</b> ›GLOW‹</p> <ul style="list-style-type: none"> <li>• neon <b>yellow safety colour</b></li> <li>• <b>gel inlays</b> reduce pressure on the ulnar nerve and the carpal tunnel. This helps against paraesthesia in the hands.</li> <li>• with <b>360° reflective</b> applications</li> <li>• thumb and forefinger with <b>contact area for touchscreen operation</b></li> <li>• with <b>loops as take-off assistance</b></li> <li>• outside partly out of <b>elastic lycra</b></li> <li>• <b>breathable</b> and <b>washable</b></li> <li>• <b>elastic waistband</b></li> <li>• on M-Wave eurohole card</li> </ul>	
<p><b>719935</b> Größe M</p> <p><b>719936</b> Größe L</p> <p><b>719937</b> Größe XL</p> <p>250/5 pair</p>	<p><b>GEL-FAHRRADHANDSCHUHE</b> ›GLOVERS‹</p> <ul style="list-style-type: none"> <li>• <b>Geleinlagen</b> verringern den Druck auf den Ulnarnerv und den Karpaltunnel. Dies hilft gegen einschlafende Hände.</li> <li>• mit <b>Schweißeinlage</b></li> <li>• mit <b>Ausziehhilfe</b></li> <li>• außen teilweise aus <b>elastischem Lycra</b></li> <li>• <b>waschbar</b> und <b>atmungsaktiv</b></li> <li>• <b>elastischer Bund mit hochwertigem Klettverschluss</b></li> <li>• auf M-Wave Eurolochkarte</li> <li>• 5 Paar im Polybeutel, farbig sortiert</li> </ul>	<p><b>GEL BICYCLE GLOVES</b> ›GLOVERS‹</p> <ul style="list-style-type: none"> <li>• <b>gel inlays</b> reduce pressure on the ulnar nerve and the carpal tunnel. This helps against paraesthesia in the hands.</li> <li>• with <b>sweat band</b></li> <li>• with <b>loops as take-off assistance</b></li> <li>• outside partly out of <b>elastic lycra</b></li> <li>• <b>washable</b> and <b>breathable</b></li> <li>• <b>elastic waistband with high-quality hook and loop fastener</b></li> <li>• on M-Wave eurohole card</li> <li>• 5 pairs in PE bag, assorted colours</li> </ul>	











ART.-NR.	BESCHREIBUNG	DESCRIPTION	
	<p><b>GEL-FAHRRADHANDSCHUHE</b></p> <ul style="list-style-type: none"> <li>• mit <b>Non-Slip-Noppen</b></li> <li>• mit <b>Schweißeinlage</b></li> <li>• mit <b>Ausziehhilfe</b></li> <li>• außen teilweise aus <b>elastischem Lycra</b></li> <li>• <b>waschbar</b></li> <li>• <b>atmungsaktiv</b></li> <li>• <b>elastischer Bund</b></li> <li>• auf Ventura Eurolochkarte</li> <li>• 5 Paar im Polybeutel, farbig sortiert</li> </ul> <p><b>Ganzfingerhandschuh</b></p>	<p><b>GEL BICYCLE GLOVES</b></p> <ul style="list-style-type: none"> <li>• with <b>non-slip knobs</b></li> <li>• with <b>sweat band</b></li> <li>• with <b>loops as take-off assistance</b></li> <li>• outside partly out of <b>elastic lycra</b></li> <li>• <b>washable</b></li> <li>• <b>breathable</b></li> <li>• <b>elastic waistband</b></li> <li>• on Ventura eurohole card</li> <li>• 5 pairs in PE bag, assorted colours</li> </ul> <p><b>full finger glove</b></p>	 
719950	Größe M	size M	
719951	Größe L	size L	
719952	Größe XL	size XL	
150/5 pair		UVP 8,90 €	
	<p><b>Halbfingerhandschuh</b></p>	<p><b>half finger glove</b></p>	 
719970	Größe M	size M	
719971	Größe L	size L	
719972	Größe XL	size XL	
250/5 pair		UVP 7,90 €	
	<p><b>FAHRRADHANDSCHUHE</b></p> <ul style="list-style-type: none"> <li>• in verschiedenen Designs sortiert</li> <li>• außen <b>elastisches Lycra</b></li> <li>• innen <b>Non-Slip-Noppen</b></li> <li>• auf Ventura Eurolochkarte</li> </ul> <p>für <b>Kinder/Jugendliche</b></p> <p><b>Größe XS</b></p>	<p><b>BICYCLE GLOVES</b></p> <ul style="list-style-type: none"> <li>• in different designs assorted</li> <li>• outside made of <b>elastic lycra</b></li> <li>• inside <b>non-slip knobs</b></li> <li>• on Ventura eurohole card</li> </ul> <p>for <b>children/youths</b></p> <p><b>size XS</b></p>	 
719983	farbig sortiert	sorted by colour	
250/5 pair			
719994	Smile, neongelb	Smile, neon yellow	
200/5 pair			
719984	farbig sortiert	sorted by colour	
250/5 pair			
719995	Smile, neongelb	Smile, neon yellow	
200/5 pair		UVP 4,90 €	
	<p>für <b>Erwachsene/Jugendliche</b></p>	<p>for <b>adults/youths</b></p>	 
719985	Größe M	size M	
719986	Größe L/XL	size L/XL	
250/5 pair		UVP 4,90 €	

ART.-NR. 	BESCHREIBUNG	DESCRIPTION	
<b>715157</b> 16	<b>FAHRRADGARAGE ›CARGO‹</b> <ul style="list-style-type: none"> <li>• <b>extra groß</b>, für einspurige Lastenräder, ideal für Transportfläche vorne</li> <li>• <b>schützt</b> vor Sonne, Schnee, Regen,....</li> <li>• aus <b>widerstandsfähigem</b> Tarpaulin</li> <li>• Größe ca. 290 x 120 x 70 cm</li> <li>• mit elastischem Bund, Klett- und Schnellverschlussbändern</li> <li>• Öffnung für sehr breite Lenker, Spiegel, ...</li> <li>• im Polybeutel mit Euroloch</li> </ul>	<b>BICYCLE GARAGE ›CARGO‹</b> <ul style="list-style-type: none"> <li>• <b>extra big</b>, for single-track cargo bikes, ideal for front transport surface</li> <li>• <b>protects</b> from sun, snow, rain, ...</li> <li>• made of <b>resistant</b> tarpaulin</li> <li>• size approx. 290 x 120 x 70 cm</li> <li>• with elastic waistband, hook and loop fastener and quick release tapes</li> <li>• opening for very wide handlebars, mirrors, ...</li> <li>• in PE bag with eurohole</li> </ul>	    <p style="text-align: right;">UVP 38,90 €</p>
<b>715164</b> 16	<b>FAHRRAD-, ROLLERGARAGE</b> <ul style="list-style-type: none"> <li>• <b>schützt vor Sonne, Schnee, Regen, ...</b></li> <li>• mit <b>Mittelverschluss</b></li> <li>• passend für alle gängigen Fahrräder, Roller, ...</li> <li>• im Polybeutel mit Euroloch</li> </ul>	<b>BICYCLE, SCOOTER GARAGE</b> <ul style="list-style-type: none"> <li>• <b>protects from sun, snow, rain, ...</b></li> <li>• with <b>central closure</b></li> <li>• suitable for all standard bicycles, scooters, ...</li> <li>• in PE bag with eurohole</li> </ul>	   <p style="text-align: right;">UVP 24,90 €</p>
<b>715160</b> 40	<b>XL-Größe</b> , ca. 200 x 110 cm, aus PEVA-Material	<b>XL size</b> , approx. 200 x 110 cm, made of PEVA material	   <p style="text-align: right;">UVP 6,80 €</p>
<b>714823</b>  <b>714841</b> 36	<b>INDOOR FAHRRADGARAGE ›VELOSOCK‹</b> <ul style="list-style-type: none"> <li>• besonders geeignet für <b>Wohnungen, Autos, ...</b></li> <li>• ideal für 26" - 29" Fahrräder (1,6 - 2 m)</li> <li>• <b>3D-stretch: sehr dehnbare Material</b>, welches sich der jeweiligen Form des Fahrrads anpasst</li> <li>• 90 % Polyester, 10 % <b>Spandex</b></li> <li>• waschmaschinenfest</li> <li>• in Velosock Eurolochbox</li> </ul>	<b>INDOOR BICYCLE GARAGE ›VELOSOCK‹</b> <ul style="list-style-type: none"> <li>• particularly suitable for <b>flats, cars, ...</b></li> <li>• ideal for 26" - 29" bicycles (1.6 - 2 m)</li> <li>• <b>3D-stretch: very stretchable material</b> which adapts to the shape of the bicycle</li> <li>• 90 % Polyester, 10 % <b>Spandex</b></li> <li>• machine washable</li> <li>• in Velosock eurohole box</li> </ul>	    <p style="text-align: right;">UVP 49,90 €</p>

E  
Y  
E  
W  
E  
A  
R



ART.-NR. 	BESCHREIBUNG	DESCRIPTION	
	<p><b>FAHRRAD-/SPORTBRILLEN ›RAYON‹</b></p> <ul style="list-style-type: none"> <li>• <b>UV400-Schutz</b></li> <li>• ISO 12312-1 : 2015-12</li> <li>• mit <b>Mikrofaser-Schutzhülle</b></li> <li>• mit fast <b>unzerbrechlichen</b> Polycarbonat <b>Sicherheitsgläsern</b></li> <li>• <b>Antikratzbeschichtung</b></li> <li>• in M-Wave Kunststoffbox</li> </ul>	<p><b>BIKE/SPORTS EYEWEAR ›RAYON‹</b></p> <ul style="list-style-type: none"> <li>• <b>UV400 protection</b></li> <li>• ISO 12312-1 : 2015-12</li> <li>• with <b>microfibre bag</b></li> <li>• with almost <b>unbreakable</b> polycarbonate <b>security lenses</b></li> <li>• <b>scratch proof treatment</b></li> <li>• in M-Wave plastic box</li> </ul>	<p><b>ISO 12312-1 : 2015-12</b></p> 
<p><b>710169</b> 100/10</p>	<p><b>FAHRRAD-/SPORTBRILLE ›RAYON PC ULTRA‹</b></p> <ul style="list-style-type: none"> <li>• mit <b>photochromen Gläsern</b>: Photochrome Gläser sind Gläser, die durch ihre Schattierungstechnik mittels eines chemischen Prozesses <b>nachdunkeln</b> sobald sie der UV-Strahlung der Sonne ausgesetzt sind. Sie reagieren nicht auf künstliches Licht. Diese Gläser vereinen Mode und Komfort, bieten <b>Schutz</b> vor den schädlichen Auswirkungen der UV-Strahlung und vor Blendung. In dunkler Umgebung (Tunnel, Wald ...) hellen sie sich wieder auf.</li> <li>• mit zusätzlichen <b>klaren, orangen, braunen Ersatzgläsern</b></li> <li>• <b>superleicht</b> und <b>extrem biegsam</b> durch <b>Grilamid-TR 90 Rahmen</b></li> <li>• mit <b>weichen</b> Nasenbügeln</li> <li>• mit <b>weichen</b> Bügelendeinlagen</li> <li>• Rahmen mattschwarz</li> </ul>	<p><b>BIKE/SPORTS EYEWEAR ›RAYON PC ULTRA‹</b></p> <ul style="list-style-type: none"> <li>• with <b>photochromic lenses</b>: Photochromic lenses are the tint changing lenses that <b>darken</b> due to a chemical process when exposed to UV rays from the sun. They do not react to artificial light. These lenses combine fashion with comfort, offer <b>protection</b> from the damaging effects of UV radiation and glare. In dark surroundings (tunnel, forest ...) they will brighten again.</li> <li>• with additional <b>clear, orange, brown spare lenses</b></li> <li>• <b>super light</b> and <b>extremely flexible</b> thru <b>Grilamid-TR 90 arms</b></li> <li>• with <b>soft</b> nose pads</li> <li>• with <b>soft</b> temple tips</li> <li>• frame matt black</li> </ul> <p style="text-align: right;">UVP 52,90 €</p>	<p><b>PHOTOCHROMIC LENS</b></p> <p><b>EXTREMELY FLEXIBLE</b></p>   <p><b>NORMAL</b>      <b>UV-LIGHT</b></p> 
<p><b>710170</b> 100/10</p>	<p><b>FAHRRAD-/SPORTBRILLE ›RAYON G4 PRO‹</b></p> <ul style="list-style-type: none"> <li>• Rahmen aus <b>Polycarbonat</b></li> <li>• mit <b>auswechselbaren, rot Iridium beschichteten</b> Gläsern</li> <li>• mit zusätzlichen dunkel <b>entspiegeln, orangen</b> und <b>klaren</b> Ersatzgläsern</li> <li>• mit <b>seitlichem Windschutz</b></li> <li>• mit <b>anatomischer Wangenform</b></li> <li>• mit <b>weichen, verstellbaren</b> Nasenbügeln</li> <li>• Rahmen mattschwarz</li> </ul>	<p><b>BIKE/SPORTS EYEWEAR ›RAYON G4 PRO‹</b></p> <ul style="list-style-type: none"> <li>• <b>polycarbonate</b> frame</li> <li>• with <b>exchangeable, red Iridium coated</b> lenses</li> <li>• with additional <b>anti-glare, orange</b> and <b>clear</b> spare lenses</li> <li>• with <b>lateral wind protector</b></li> <li>• with <b>anatomic cheek shape</b></li> <li>• with <b>soft, adjustable</b> nose pads</li> <li>• frame matt black</li> </ul> <p style="text-align: right;">UVP 42,90 €</p>	 <p><b>SIDE GUARD</b></p> <p><b>ANTI REFLEX COATING</b>      <b>CHOPS RELIEVE</b>      <b>IRIDIUM COATED</b></p> 
<p><b>710160</b> 100/10</p>	<p><b>FAHRRAD-/SPORTBRILLE ›RAYON ONE‹</b></p> <ul style="list-style-type: none"> <li>• Rahmen aus <b>Polycarbonat</b></li> <li>• mit <b>blau Iridium beschichteten</b> Gläsern</li> <li>• mit zusätzlichen <b>klaren, orangen</b> und <b>dunklen</b> Ersatzgläsern</li> <li>• mit <b>weichen flexiblen</b> Nasenbügeln</li> <li>• gummierte Brillenbügel</li> <li>• Rahmen schwarz / grau</li> </ul>	<p><b>BIKE/SPORTS EYEWEAR ›RAYON ONE‹</b></p> <ul style="list-style-type: none"> <li>• <b>polycarbonate</b> frame</li> <li>• with <b>blue Iridium coated</b> lenses</li> <li>• with additional <b>clear, orange</b> and <b>dark</b> spare lenses</li> <li>• with <b>soft flexible</b> nose pads</li> <li>• rubber temples</li> <li>• frame black / grey</li> </ul> <p style="text-align: right;">UVP 34,90 €</p>	 



ART.-NR.	BESCHREIBUNG	DESCRIPTION	
<b>710162</b> 100/10	<b>FAHRRAD-/SPORTBRILLE</b> <b>›RAYON G4‹</b> <ul style="list-style-type: none"> <li>extrem guter Sonnenschutz durch <b>Iridium beschichtete Gläser</b> (austauschbar)</li> <li>mit zusätzlichen <b>klaren, orangen, braunen</b> und <b>dunklen Ersatzgläsern</b></li> <li><b>superleicht</b> und <b>extrem biegsam</b> durch <b>Grilamid-TR 90 Rahmen</b></li> <li>mit <b>weichen</b> Bügelendeinlagen</li> <li>mit <b>weichen</b> Nasenbügeln</li> <li>Rahmen mattschwarz</li> </ul>	<b>BIKE/SPORTS EYEWEAR</b> <b>›RAYON G4‹</b> <ul style="list-style-type: none"> <li>perfect sun protection by exchangeable <b>iridium coated</b> replacement <b>lenses</b></li> <li>with additional <b>clear, orange, brown</b> and <b>dark spare lenses</b></li> <li><b>super light</b> and <b>extremely flexible</b> thru <b>Grilamid-TR 90 arms</b></li> <li>with <b>soft</b> temple tips</li> <li>with <b>soft</b> nose pads</li> <li>frame matt black</li> </ul>	 <div style="position: absolute; top: 105px; left: 605px; border: 1px solid black; padding: 2px;">   19 g </div> <div style="position: absolute; top: 200px; left: 770px; border: 1px solid black; padding: 2px;"> IRIDIUM COATED </div> <div style="position: absolute; top: 240px; left: 750px; border: 1px solid black; padding: 2px;"> EXTREMELY FLEXIBLE </div> <div style="text-align: right; margin-top: 10px;">UVP 26,90 €</div>
<b>710163</b> 100/10	<b>FAHRRAD-/SPORTBRILLE</b> <b>›RAYON IN-SIGHT‹</b> <ul style="list-style-type: none"> <li>getönte Gläser <b>aufklappbar</b></li> <li>mit <b>herausnehmbarer Halterung für optische Sehhilfen</b></li> <li>mit <b>auswechselbaren, dunklen</b> Gläsern</li> <li>mit zusätzlichen <b>klaren, orangen</b> und <b>braunen Ersatzgläsern</b></li> <li>mit <b>weichen</b> Bügelendeinlagen</li> <li>mit <b>weichen</b> Nasenbügeln</li> <li>Rahmen matt-dunkelanthrazit</li> </ul>	<b>BIKE/SPORTS EYEWEAR</b> <b>›RAYON IN-SIGHT‹</b> <ul style="list-style-type: none"> <li>dark lenses <b>folding</b></li> <li>with <b>removable frame for optical lenses</b></li> <li>with <b>exchangeable, dark</b> lenses</li> <li>with additional <b>clear, orange</b> and <b>brown spare lenses</b></li> <li>with <b>soft</b> temple tips</li> <li>with <b>soft</b> nose pads</li> <li>frame matt dark anthracite</li> </ul>	<div style="text-align: center; margin-bottom: 5px;"><b>OPTICAL LENSES</b></div>  <div style="position: absolute; top: 410px; left: 715px; border: 1px solid black; padding: 2px;"> 2 IN 1 </div> <div style="text-align: right; margin-top: 10px;">UVP 26,90 €</div>
<b>710161</b> 100/10	<b>FAHRRAD-/SPORTBRILLE</b> <b>›RAYON FLEXI 4‹</b> <ul style="list-style-type: none"> <li>mit <b>auswechselbaren, dunklen</b> Gläsern</li> <li>mit <b>weichen</b> Nasenbügeln</li> <li>mit <b>weichen</b> Bügelendeinlagen</li> </ul>	<b>BIKE/SPORTS EYEWEAR</b> <b>›RAYON FLEXI 4‹</b> <ul style="list-style-type: none"> <li>with <b>exchangeable</b> dark lenses</li> <li>with <b>soft</b> nose pads</li> <li>with <b>soft</b> temple tips</li> </ul>	 <div style="text-align: right; margin-top: 10px;">UVP 19,90 €</div>
<b>710167</b> 100/10 <span style="background-color: #0056b3; color: white; padding: 2px;">NICE PRICE</span>	<ul style="list-style-type: none"> <li>Rahmen <b>mattschwarz</b></li> <li>mit zusätzlichen <b>klaren, orangen</b> und <b>braunen Ersatzgläsern</b></li> </ul>	<ul style="list-style-type: none"> <li>frame <b>matt black</b></li> <li>with additional <b>clear, orange</b> and <b>brown spare lenses</b></li> </ul>	 <div style="text-align: right; margin-top: 10px;">UVP 17,90 €</div>
<b>710171</b> 100/10	<b>FAHRRAD-/SPORTBRILLE</b> <b>›RAYON F1‹</b> <ul style="list-style-type: none"> <li>mit dunklen, <b>polarisierenden</b> Gläsern aus <b>Tri-Acetat Cellulose</b></li> <li><b>mildert Blendeffekte</b>, Spiegelungen, Lichtreflexe</li> <li>bessere <b>Wahrnehmung von Kontrasten und Farben</b></li> <li><b>geringere Ermüdung</b> der Augen</li> <li>mit <b>weichen</b> Bügelendeinlagen</li> <li>Rahmen in dunkelgrau</li> </ul>	<b>BIKE/SPORTS EYEWEAR</b> <b>›RAYON F1‹</b> <ul style="list-style-type: none"> <li>with dark, <b>polarised</b> glasses made of <b>Tri-Acetat Cellulose</b></li> <li><b>softens glare</b>, reflections, light reflections</li> <li>better <b>awareness of contrasts and colours</b></li> <li><b>less eye fatigue</b></li> <li>with <b>soft</b> temple tips</li> <li>frame dark grey</li> </ul>	<div style="text-align: center; margin-bottom: 5px;"><b>POLARISED LENSES</b></div>  <div style="text-align: right; margin-top: 10px;">UVP 17,90 €</div>



# HELMETS



Art. 731298



ART.-NR.	BESCHREIBUNG	DESCRIPTION	
<b>M-WAVE</b>			
	<p>Bezahlbare Sicherheit und ein attraktiver Look müssen keine Gegensätze sein. Unsere Helme sind ein exzellentes Beispiel hierfür.</p> <p>Alle Helme sind gemäß EN-1078 geprüft und verfügen über ein CE-Zeichen. Sie gewährleisten höchste Sicherheit. Unser Sortiment deckt die unterschiedlichsten Einsatzbereiche ab. Alle unsere Helme sind in einer Box verpackt.</p>	<p>Affordable security and an attractive look do not have to be opposites. Our Helmets are an excellent example here for.</p> <p>All helmets are in accordance with EN 1078 and have a CE sign. They guarantee highest safety. Our product range covers extensive areas of use. All helmets are packed in a box.</p>	<b>M-WAVE</b>
<p><b>731298</b></p> <p><b>731299</b></p> <p>6</p>	<p><b>DOWNHILL HELM ›FALL OUT‹</b></p> <p><b>Maximale Sicherheit</b> ohne Kompromisse! Dies war die Vorgabe bei der Entwicklung des ›Fall Out‹ - Helms. Als Vollvisierhelm ist er für den harten Downhilleinsatz o. Ä. konzipiert. Die spezielle <b>Thermoplast-Hartschale</b> mit den <b>Metallgitterversteifungen</b> kann auch harte Einschläge wegstecken.</p> <p>Belüftung: 18 Öffnungen Gewicht: 870 g (M, mit Visier) Komfort: herausnehmbare, <b>waschbare</b> Comfort Pads Technologie: <b>Thermoplast Hartschale mit Metallgitterversteifung</b> Visier: abnehmbares Anschraubvisier</p> <p>Größe M, 53 - 56 cm (Jugend/<b>Kind</b>)</p> <p>Größe L, 57 - 61 cm (Erwachsene)</p>	<p><b>DOWNHILL HELMET ›FALL OUT‹</b></p> <p><b>Maximum safety</b> without compromise! This was the main premiss for the development of the ›Fall Out‹ helmet. As a full visor helmet it was designed for hardcore usage, like downhill riding or similar. The special <b>thermoplast hard shell with metal mesh reinforcements</b> can even absorb hard impacts.</p> <p>ventilation: 18 holes weight: 870 g (M, with visor) comfort: removable, <b>washable</b> comfort pad technology: <b>thermoplast hard shell with metal mesh reinforcement</b> visor: detachable screw-on visor</p> <p>size M, 53 - 56 cm (youth/<b>kid</b>)</p> <p>size L, 57 - 61 cm (adult)</p> <p style="text-align: right;">UVP 123,00 €</p>	<p style="text-align: right;"><small>according to EN 1078</small></p>   
<p><b>731140</b></p> <p><b>731141</b></p> <p>10</p>	<p><b>DOWNHILL HELM ›ALL IN 1‹</b></p> <p>Belüftung: 17 Öffnungen Gewicht: 650 - 710 g (M, mit Visier) Einstellsystem: <b>Kopfgröße anpassbar</b> durch 2 verschiedene Polster-Sets Komfort: herausnehmbare, waschbare Comfort Pads Technologie: <b>ABS Hardshell, Integralhelm:</b> abnehmbarer Kinnschutz Visier: abnehmbares Anschraubvisier</p> <p>Größe M, 54 - 58 cm</p> <p>Größe L, 58 - 61 cm</p>	<p><b>DOWNHILL HELMET ›ALL IN 1‹</b></p> <p>ventilation: 17 holes weight: 650 - 710 g (M, with visor) adjustment system: <b>adjustable to head size</b> by 2 different pads comfort: removable, washable comfort pads technology: <b>ABS hard shell, full face helmet:</b> detachable chin protector visor: detachable screw-on visor</p> <p>size M, 54 - 58 cm</p> <p>size L, 58 - 61 cm</p> <p style="text-align: right;">UVP 61,90 €</p>	<p style="text-align: right;"><small>according to EN 1078</small></p>  <p><b>ALL IN 1</b></p>  





ART.-NR. 	BESCHREIBUNG	DESCRIPTION	
	<p><b>FAHRRADHELM ›ACTIVE‹</b></p> <p>Belüftung: 11 Öffnungen            Gewicht: 235-265 g (M, mit Visier)            Einstellsystem: <b>Ringsystem</b>, mit Reflex            Komfort: herausnehmbare, waschbare Pads            Technologie: <b>Microshell</b> Oberschale            Visier: aufsteckbares Visier            Sicherheit: Mückenschutz, Reflex-Aufkleber</p> <p>Design: <b>White Carbon</b></p> <p><b>733128</b> Größe M, 53 - 57 cm (Jugend)  <b>733129</b> Größe L, 58 - 61 cm (Erwachsene)</p> <p>Design: <b>Blue Spots</b></p> <p><b>731027</b> Größe M, 53 - 57 cm (Jugend)  <b>731028</b> Größe L, 58 - 61 cm (Erwachsene)</p> <p>Design: <b>Mamba</b></p> <p><b>731036</b> Größe M, 53 - 57 cm (Jugend)  <b>731037</b> Größe L, 58 - 61 cm (Erwachsene)</p> <p>Design: <b>red/black/white/silver</b></p> <p><b>731034</b> Größe M, 53 - 57 cm (Jugend)  <b>731035</b> Größe L, 58 - 61 cm (Erwachsene)</p> <p>Design: <b>White Flower</b></p> <p><b>731032</b> Größe M, 53 - 57 cm (Jugend)  <b>731033</b> Größe L, 58 - 61 cm (Erwachsene)</p> <p>10</p>	<p><b>BICYCLE HELMET ›ACTIVE‹</b></p> <p>ventilation: 11 holes            weight: 235-265 g (M, with visor)            adjustment system: <b>ring system</b>, with reflex removable, washable comfort pads            comfort: <b>ring system</b>, with reflex removable, washable comfort pads            technology: <b>Microshell</b> face plate            visor: stick-on visor            security: mosquito net, reflex sticker</p> <p>design: <b>White Carbon</b></p> <p>size M, 53 - 57 cm (youth)            size L, 58 - 61 cm (adult)</p> <p>design: <b>Blue Spots</b></p> <p>size M, 53 - 57 cm (youth)            size L, 58 - 61 cm (adult)</p> <p>design: <b>Mamba</b></p> <p>size M, 53 - 57 cm (youth)            size L, 58 - 61 cm (adult)</p> <p>design: <b>red/black/white/silver</b></p> <p>size M, 53 - 57 cm (youth)            size L, 58 - 61 cm (adult)</p> <p>design: <b>White Flower</b></p> <p>size M, 53 - 57 cm (youth)            size L, 58 - 61 cm (adult)</p> <p>UVP 28,90 €</p>	<p>according to EN 1078</p>      
	<p><b>BMX HELM ›LAUNCH‹</b></p> <p>Belüftung: 11 Öffnungen            Gewicht: 380 g (M)            Einstellsystem: <b>Ringsystem</b>            Komfort: herausnehmbare, waschbare Pads            Technologie: <b>ABS Hardshell</b></p> <p>Design: <b>matt black</b></p> <p><b>731184</b> Größe M, 54 - 58 cm  <b>731284</b> Größe L, 58 - 61 cm</p> <p>Design: <b>black</b></p> <p><b>731182</b> Größe M, 54 - 58 cm  <b>731282</b> Größe L, 58 - 61 cm</p> <p>Design: <b>white</b></p> <p><b>731183</b> Größe M, 54 - 58 cm  <b>731283</b> Größe L, 58 - 61 cm</p> <p>Design: <b>matt green</b></p> <p><b>731475</b> Größe M, 54 - 58 cm  <b>731485</b> Größe L, 58 - 61 cm</p> <p>10</p>	<p><b>BMX HELMET ›LAUNCH‹</b></p> <p>ventilation: 11 holes            weight: 380 g (M)            adjustment system: <b>ring system</b>            comfort: removable, washable comfort pads            technology: <b>ABS hard shell</b></p> <p>design: <b>matt black</b></p> <p>size M, 54 - 58 cm            size L, 58 - 61 cm</p> <p>design: <b>black</b></p> <p>size M, 54 - 58 cm            size L, 58 - 61 cm</p> <p>design: <b>white</b></p> <p>size M, 54 - 58 cm            size L, 58 - 61 cm</p> <p>design: <b>matt green</b></p> <p>size M, 54 - 58 cm            size L, 58 - 61 cm</p> <p>UVP 29,90 €</p>	<p>according to EN 1078</p>     



ART.-NR. 	BESCHREIBUNG	DESCRIPTION	
<p><b>731880</b></p> <p><b>731881</b></p> <p><b>731882</b></p> <p><b>731883</b></p> <p><b>731884</b></p> <p><b>731885</b></p> <p>10</p>	<p><b>KINDERHELM ›JUNIOR‹</b></p> <p>Was ist das wichtigste an einem Kinderhelm? Ganz klar die <b>Sicherheit</b>. Damit aber der Tragekomfort nicht zu kurz kommt, haben unsere Kinderhelme <b>zahlreiche Einstellmöglichkeiten</b>. Und zur Freude der Eltern macht das Helmtragen mit unseren <b>attraktiven Designs</b> auch noch Spaß!</p> <p>Belüftung: 12 Öffnungen Gewicht: <b>213 g</b> (XS) Einstellsystem: Ringsystem mit <b>Reflex</b> Komfort: herausnehmbare, waschbare Comfort Pads, mit zusätzlichem Ersatz-Pad-Set</p> <p>Technologie: <b>In-Mould</b> Microshell Visier: integriert Sicherheit: Mückenschutz, Reflex-Aufkleber</p> <p>Design: <b>Zoo</b> weiß</p> <p>Größe XS, 48 - 54 cm</p> <p>Größe S, 52 - 56 cm</p> <p>Design: <b>Race</b> schwarz / gelb</p> <p>Größe XS, 48 - 54 cm</p> <p>Größe S, 52 - 56 cm</p> <p>Design: <b>Sweet</b> pink</p> <p>Größe XS, 48 - 54 cm</p> <p>Größe S, 52 - 56 cm</p>	<p><b>CHILDREN HELMET ›JUNIOR‹</b></p> <p>What's the most important thing about children's helmets? <b>Safety</b>, of course. However, our children's helmets have <b>numerous adjustment</b> possibilities, so that comfort is not sacrificed. Parents will see that wearing one of our <b>fashionable children's helmets</b> is safe and also fun!</p> <p>ventilation: 12 holes weight: <b>213 g</b> (XS) adjustment system: ring system with <b>reflex</b> comfort: removable, washable comfort pads, with additional replacement pad set</p> <p>technology: <b>In-Mould</b> Microshell visor: integrated security: mosquito net, reflex sticker</p> <p>design: <b>Zoo</b> white</p> <p>size XS, 48 - 54 cm size S, 52 - 56 cm</p> <p>design: <b>Race</b> black / yellow</p> <p>size XS, 48 - 54 cm size S, 52 - 56 cm</p> <p>design: <b>Sweet</b> pink</p> <p>size XS, 48 - 54 cm size S, 52 - 56 cm</p> <p>UVP 29,90 €</p>	<p>according to EN 1078</p> <p> 213 g</p> <p></p> <p><b>REFLEX</b></p> <p></p> <p></p> <p></p> <p></p>
<p><b>730231</b></p> <p><b>734072</b></p> <p><b>734070</b></p> <p>10</p>	<p><b>KINDERHELM ›KID-X-S‹</b></p> <p>Belüftung: 6 Öffnungen Gewicht: 200 g (XS) Einstellsystem: <b>Ringsystem</b> Komfort: herausnehmbare, waschbare Pads</p> <p>Technologie: <b>Microshell</b> Oberschale Visier: integriert Sicherheit: Mückenschutz Größe: <b>XS, 46 - 52 cm</b></p> <p>Design: <b>Smile</b> neongelb</p> <p>Design: <b>Teddy</b> blau</p> <p>Design: <b>Frog</b> rot</p>	<p><b>CHILDREN HELMET ›KID-X-S‹</b></p> <p>ventilation: 6 holes weight: 200 g (XS) adjustment system: <b>ring system</b> comfort: removable, washable comfort pads</p> <p>technology: <b>Microshell</b> face plate visor: integrated security: mosquito net size: <b>XS, 46 - 52 cm</b></p> <p>design: <b>Smile</b> neon yellow</p> <p>design: <b>Teddy</b> blue</p> <p>design: <b>Frog</b> red</p> <p>UVP 21,90 €</p>	<p>according to EN 1078</p> <p> 200 g</p> <p><b>XS</b></p> <p></p> <p><b>RING SYSTEM</b></p> <p></p> <p></p> <p></p> <p></p>

ART.-NR.	BESCHREIBUNG	DESCRIPTION	
<p><b>731125</b> 10</p>	<p><b>KINDERHELM ›KID-S‹</b>                      Belüftung: 6 Öffnungen                      Gewicht: 190 g (S)                      Einstellsystem: <b>Ringsystem</b>                      Komfort: herausnehmbare, waschbare Pads                      Technologie: <b>Microshell</b> Oberschale                      Visier: integriert                      Sicherheit: Mückenschutz                      Größe: <b>S, 52 - 57 cm</b></p> <p>Design: <b>Space</b>                      blau, mit <b>Reflexmaterial</b></p>	<p><b>CHILDREN HELMET ›KID-S‹</b>                      ventilation: 6 holes                      weight: 190 g (S)                      adjustment system: <b>ring system</b>                      comfort: removable, washable comfort pads                      technology: <b>Microshell</b> face plate                      visor: integrated                      security: mosquito net                      size: <b>S, 52 - 57 cm</b></p> <p>design: <b>Space</b>                      blue, with <b>reflective material</b></p> <p>UVP 20,90 €</p>	<p>according to EN 1078</p>   <p><b>RING SYSTEM</b></p>  <p><b>REFLEX</b></p> 
<p><b>730230</b></p> <p><b>731004</b></p> <p><b>731007</b></p> <p><b>734040</b></p> <p><b>731123</b></p> <p><b>731006</b></p> <p><b>731000</b></p> <p><b>731076</b></p> <p><b>731001</b> 10</p>	<p>Design: <b>Smile</b> neongelb</p> <p>Design: <b>Police</b> weiß/schwarz</p> <p>Design: <b>Soccer</b> blau</p> <p>Design: <b>Little Devil</b> rot/gelb</p> <p>Design: <b>Wizard</b> blau/violett/schwarz</p> <p>Design: <b>Curly</b> rosa</p> <p>Design: <b>Sea Land</b> blau</p> <p>Design: <b>Sea Land</b> gelb</p> <p>Design: <b>Flower</b> pink</p>	<p>design: <b>Smile</b> neon yellow</p> <p>design: <b>Police</b> white/black</p> <p>design: <b>Soccer</b> blue</p> <p>design: <b>Little Devil</b> red/yellow</p> <p>design: <b>Wizard</b> blue/purple/black</p> <p>design: <b>Curly</b> rose</p> <p>design: <b>Sea Land</b> blue</p> <p>design: <b>Sea Land</b> yellow</p> <p>design: <b>Flower</b> pink</p> <p>UVP 19,90 €</p>	         



ART.-NR.	BESCHREIBUNG	DESCRIPTION	
			<b>SKI</b>
			<b>WINTER</b>
			<b>SNOWBOARD</b>
	<p><b>SKIHELM ›UNIVERSAL‹</b></p> <p>Belüftung: 5 Öffnungen, von denen <b>2 verschließbar</b> sind</p> <p>Gewicht: 475 - 505 g</p> <p>Einstellsystem: <b>Ringsystem</b></p> <p>Komfort: warme, atmungsaktive <b>Innenpolsterung</b>, Kinnschutz</p> <p>Technologie: <b>Hardshell</b> Oberschale aus <b>schlagfestem ABS-Kunststoff</b></p> <p>Extras: mit integriertem Skibrillenhalter, abnehmbarer Ohrenschutz</p> <p>Design: <b>black</b></p> <p><b>733077</b> Größe S, 52 - 55 cm (Kinder)</p> <p><b>733078</b> Größe M, 55 - 58 cm (Jugend)</p> <p><b>733079</b> Größe L, 58 - 59,5 cm (Erwachsene)</p> <p>Design: <b>white</b></p> <p><b>733034</b> Größe S, 52 - 55 cm (Kinder)</p> <p><b>733035</b> Größe M, 55 - 58 cm (Jugend)</p> <p><b>733036</b> Größe L, 58 - 59,5 cm (Erwachsene)</p> <p>Design: <b>blue</b></p> <p><b>733004</b> Größe S, 52 - 55 cm (Kinder)</p> <p><b>733005</b> Größe M, 55 - 58 cm (Jugend)</p> <p><b>733006</b> Größe L, 58 - 59,5 cm (Erwachsene)</p> <p>6</p>	<p><b>SKI HELMET ›UNIVERSAL‹</b></p> <p>ventilation: 5 holes, <b>2 of them are closable</b></p> <p>weight: 475 - 505 g</p> <p>adjustment system: <b>ring system</b></p> <p>comfort: warm, breathable <b>inner padding</b>, chin protection</p> <p>technology: <b>Hardshell</b> face plate made of <b>shock-resistant ABS special nylon</b></p> <p>extras: with integrated bracket for ski glasses, removeable ear protectors</p> <p>design: <b>black</b></p> <p>size S, 52 - 55 cm (children)</p> <p>size M, 55 - 58 cm (youth)</p> <p>size L, 58 - 59.5 cm (adult)</p> <p>design: <b>white</b></p> <p>size S, 52 - 55 cm (children)</p> <p>size M, 55 - 58 cm (youth)</p> <p>size L, 58 - 59.5 cm (adult)</p> <p>design: <b>blue</b></p> <p>size S, 52 - 55 cm (children)</p> <p>size M, 55 - 58 cm (youth)</p> <p>size L, 58 - 59.5 cm (adult)</p> <p>UVP 45,90 €</p>	<p>according to EN 1077</p>      
<b>731903</b>	<p><b>STURZRING ›RETRO‹</b></p> <p>20</p> <ul style="list-style-type: none"> <li>• stylische <b>Retro-Kopfbedeckung</b> in Echtlederoptik</li> <li>• <b>sehr gute Belüftung</b> und <b>Sonnenschutz</b></li> <li>• trendiges Outfit für <b>Single-Speed-Räder</b>, ...</li> <li>• inkl. Pads</li> <li>• Größe 58 - 61 cm</li> <li>• braun</li> <li>• kein Fahrradhelm nach EN 1078 o. ä.!</li> </ul>	<p><b>CRASH CAP ›RETRO‹</b></p> <ul style="list-style-type: none"> <li>• stylish <b>retro cycling cap</b> in genuine leather look</li> <li>• <b>very good ventilation</b> and <b>sun protection</b></li> <li>• trendy outfit for <b>single speed bikes</b>, ...</li> <li>• incl. pads</li> <li>• size 58 - 61 cm</li> <li>• brown</li> <li>• no bicycle helmet acc. to EN 1078 or similar!</li> </ul> <p>UVP 61,90 €</p>	 
<b>720225</b>	<p><b>STURMHAUBE</b></p> <p>200</p> <ul style="list-style-type: none"> <li>• aus Baumwolle</li> <li>• schwarz</li> </ul>	<p><b>HEAD CAP</b></p> <ul style="list-style-type: none"> <li>• cotton</li> <li>• black</li> </ul> <p>UVP 4,90 €</p>	

# HELMZUBEHÖR HELMET ACCESSORIES

ART.-NR. 	BESCHREIBUNG	DESCRIPTION	
<b>081082</b> 1	<b>HELM-AUSSTELLUNGSSTÄNDER &gt;TOP ASSIST&lt;</b> <ul style="list-style-type: none"> <li>• für bis zu <b>20 Helme</b></li> <li>• mit versetzbarem <b>Spiegel</b></li> <li>• <b>mobil</b> durch <b>4 Rollen</b></li> <li>• ca. 226 (H) x 60 (B) x 60 cm (T)</li> <li>• individueller Logo-Aufkleber auf Wunsch möglich</li> </ul>	<b>HELMET DISPLAY &gt;TOP ASSIST&lt;</b> <ul style="list-style-type: none"> <li>• for up to <b>20 helmets</b></li> <li>• with moveable <b>mirror</b></li> <li>• <b>mobile</b> by <b>4 rolls</b></li> <li>• approx. 226 (H) x 60 (W) x 60 cm (D)</li> <li>• individual logo sticker on request</li> </ul>	

UVP 259,00 €

## EINFACH **BIO**CLEAN

MEHR ALS  
NUR SAUBER

Die umweltfreundliche und effiziente Teilereinigung von Motul



**MOTUL** **BIO**CLEAN

[www.motul.messingschlagel.com](http://www.motul.messingschlagel.com)



# MOTUL



**LUBRICANT SPECIALIST**  
Based in France since 1956



**EXCLUSIVE TECHNOLOGIES**  
ESTER Technosynthese®



**CREATOR OF THE FIRST**  
100 % synthetic technology



**RECOGNIZED BY OEMs**  
Approvals & Homologations



**INTERNATIONAL FOOTPRINT**  
Present in more than 160 countries

## MOTUL<sup>®</sup> BIKE CARE

Biologisch abbaubare Formulierungen und Verzicht auf Aerosole bei der kompletten Produktlinie

Gefahrgut-Kennzeichnung unnötig

Flaschen aus 100 % recyceltem oder biologischem Material & 100 % recycelbar

Kettenöl mit innovativer Ester Technologie

Übersichtliche Produktlinie mit 8 Produkten für 4 Anwendungsbereiche (Entfetten, Reinigen, Schmierern, Vorsorge)

Exklusiv erhältlich in DE, AT, PL, CZ, SK. Weitere Länder auf Anfrage.

Biodegradable formulas and no aerosols over the complete product range

No hazardous goods pictograms

100 % recycled or biosourced & 100 % recyclable plastic bottle

Chain lubes with innovative Ester Technology

Compact range consisting of 8 SKUs in 4 application segments (degrease, clean, lubricate, prevent)

Exclusively available in DE, AT, PL, CZ, SK. Other countries on request.



ART.-NR. 	BESCHREIBUNG	DESCRIPTION	
<p><b>NEW</b></p> <p><b>881300</b></p> <p>12</p> <p><b>881301</b></p> <p>12</p> <p>Exklusiv erhältlich in DE, AT, PL, CZ, SK. Andere Länder auf Anfrage.</p>	<p><b>REINIGER</b></p> <ul style="list-style-type: none"> <li>für Fahrradrahmen und -teile</li> <li><b>vollständig biologisch abbaubar</b></li> <li>eignet sich für <b>pulverbeschichtete Oberflächen</b> sowie für eine Vielzahl von Anwendungen einschließlich der <b>empfindlichsten Materialien</b> wie Carbon, Klarlack, Chrom, Nasslack und Kunststoffe</li> <li>geeignet für konventionelle und elektrische Fahrräder</li> <li>500 ml Flasche mit Sprühkopf</li> </ul> <p><b>›MOTUL FRAME CLEAN‹</b></p> <ul style="list-style-type: none"> <li>löst selbst <b>hartnäckigste Verschmutzungen</b> gründlich</li> </ul> <p><b>›MOTUL DRY CLEAN‹</b></p> <ul style="list-style-type: none"> <li><b>ohne Abspülen</b></li> <li>erleichtert die gründliche Reinigung von Fahrradrahmen sowie von Lauf- rädern mit glänzenden und matten Oberflächen</li> <li>hinterlässt einen <b>wasserfesten Schutz</b></li> </ul>	<p><b>CLEANER</b></p> <ul style="list-style-type: none"> <li>for bicycle frames and parts</li> <li><b>fully biodegradable</b></li> <li>for <b>powder-coated surfaces</b> as well as for a wide variety of applications including the <b>most sensitive materials</b> such as carbon fiber, lacquer, chrome, paints and plastics</li> <li>suitable for conventional and electric bikes</li> <li>500 ml bottle with trigger spray</li> </ul> <p><b>›MOTUL FRAME CLEAN‹</b></p> <ul style="list-style-type: none"> <li>dissolves even the <b>toughest contaminations</b></li> </ul> <p><b>›MOTUL DRY CLEAN‹</b></p> <ul style="list-style-type: none"> <li><b>without rinsing</b></li> <li>makes it easy to thoroughly clean bicycle frames as well as wheels featuring shiny and matt surfaces</li> <li>leaves a <b>waterproof protection</b></li> </ul> <p>UVP 10,90 €</p> <p>UVP 14,90 €</p> <p>Exclusively available in DE, AT, PL, CZ, SK. Other countries on request.</p>	<p><b>STEP 1: CLEAN</b></p>
<p><b>NEW</b></p> <p><b>881306</b></p> <p>12</p>	<p><b>BREMSENREINIGER</b></p> <p><b>›MOTUL BRAKE CLEAN‹</b></p> <ul style="list-style-type: none"> <li>für <b>Bremsscheiben und mechanische Systeme</b></li> <li><b>vollständig biologisch abbaubar</b></li> <li><b>lösungsmittelfrei</b></li> <li><b>auf Wasserbasis</b></li> <li>geeignet für konventionelle und elektrische Fahrräder</li> <li>300 ml Flasche mit Sprühkopf</li> </ul>	<p><b>BRAKE CLEANER</b></p> <p><b>›MOTUL BRAKE CLEAN‹</b></p> <ul style="list-style-type: none"> <li>for <b>brake discs and mechanic systems</b></li> <li><b>fully biodegradable</b></li> <li><b>free of solvents</b></li> <li><b>waterbased</b></li> <li>suitable for conventional and electric bikes</li> <li>300 ml bottle with trigger spray</li> </ul> <p>UVP 10,90 €</p>	<p><b>STEP 2: DEGREASE</b></p>
<p><b>NEW</b></p> <p><b>881307</b></p> <p>12</p>	<p><b>KETTENREINIGER</b></p> <p><b>›MOTUL CHAIN CLEAN‹</b></p> <ul style="list-style-type: none"> <li>für <b>Fahrradketten, Kassetten und Ritzel</b></li> <li><b>vollständig biologisch abbaubar</b></li> <li>hochwirksame Lösekraft</li> <li>starke <b>Schutzwirkung</b> gegen das Anlaufen von Aluminium, Messing und Nichteisenmetallen</li> <li>geeignet für konventionelle und elektrische Fahrräder</li> <li>500 ml Flasche mit Sprühkopf</li> </ul>	<p><b>CHAIN CLEANER</b></p> <p><b>›MOTUL CHAIN CLEAN‹</b></p> <ul style="list-style-type: none"> <li>for <b>bicycle chains, cassettes and sprockets</b></li> <li><b>fully biodegradable</b></li> <li>highly effective dissolving</li> <li>strong <b>protection power</b> against tarnishing of aluminum, brass and nonferrous metals</li> <li>suitable for conventional and electric bikes</li> <li>500 ml bottle with trigger spray</li> </ul> <p>UVP 11,90 €</p> <p>Exclusively available in DE, AT, PL, CZ, SK. Other countries on request.</p>	



ART.-NR.	BESCHREIBUNG	DESCRIPTION	
<b>881302</b> 12 <b>NEW</b>	<b>SCHMIERMITTEL</b> ›MOTUL EZ LUBE‹ <ul style="list-style-type: none"> <li>für <b>mechanische Teile</b>, wie Hebel, Züge, Schalthebel, Pedale, Kurbeln, Umwerfer und alle beweglichen Teile</li> <li><b>Anti-Korrosion</b></li> <li><b>Anti-Feuchtigkeit</b></li> <li>Kriechspray</li> <li><b>vollständig biologisch abbaubar</b></li> <li>geeignet für konventionelle und elektrische Fahrräder</li> <li>300 ml Flasche mit Sprühkopf</li> </ul>	<b>LUBRICANT</b> ›MOTUL EZ LUBE‹ <ul style="list-style-type: none"> <li>for <b>mechanical parts</b>, levers, cables, shifters, pedals, cranksets, derailleurs and all moving parts</li> <li><b>protects against corrosion</b></li> <li><b>prevents humidity</b></li> <li>penetrating spray</li> <li><b>fully biodegradable</b></li> <li>suitable for conventional and electric bikes</li> <li>300 ml bottle with trigger spray</li> </ul>	<b>STEP 3: LUBRICATE</b> 
<b>NEW</b>	<b>SCHMIERMITTEL FÜR FAHRRAD-KETTEN</b> <ul style="list-style-type: none"> <li>für alle Arten von Fahrradketten</li> <li>hochmoderne <b>MOTUL Ester-Technologie</b> bietet höchsten Standard für die Schmierung von <b>Fahrradketten und Antriebssträngen</b></li> <li><b>hochpolare Moleküle mit extrem hohen Kriechfähigkeiten</b> für eine dauerhafte Haftung an der Kette und ultimative Druckbeständigkeit</li> <li><b>vollständig biologisch abbaubar</b></li> <li>geeignet für konventionelle und elektrische Fahrräder</li> <li>100 ml Flasche mit Tropfaufsatz</li> </ul>	<b>LUBRICANT FOR BICYCLE CHAINS</b> <ul style="list-style-type: none"> <li>for all types of bicycle chains</li> <li>state of the art <b>MOTUL Ester Technology</b> brings the highest standards of lubrication for <b>bicycle chains and drivetrains</b></li> <li><b>highly polar molecules with extreme high creep capabilities</b> for durable adhesion to the chain and ultimate pressure resistance</li> <li><b>fully biodegradable</b></li> <li>suitable for conventional and electric bikes</li> <li>100 ml bottle with dropper nozzle</li> </ul>	
<b>881305</b> 24	›MOTUL CHAIN LUBE WET‹ <ul style="list-style-type: none"> <li>für den Einsatz bei Nässe</li> </ul>	›MOTUL CHAIN LUBE WET‹ <ul style="list-style-type: none"> <li>for use in wet conditions</li> </ul>	UVP 10,90 €
<b>881304</b> 24	›MOTUL CHAIN LUBE DRY‹ <ul style="list-style-type: none"> <li>für den Einsatz bei Trockenheit</li> </ul>	›MOTUL CHAIN LUBE DRY‹ <ul style="list-style-type: none"> <li>for use in dry conditions</li> </ul>	UVP 10,90 €
Exklusiv erhältlich in DE, AT, PL, CZ, SK. Andere Länder auf Anfrage.		Exclusively available in DE, AT, PL, CZ, SK. Other countries on request.	
<b>881303</b> 12 <b>NEW</b>	<b>ABDICHTFLÜSSIGKEIT</b> ›MOTUL TUBELESS TIRE SEALANT‹ <ul style="list-style-type: none"> <li>zur einfache Einrichtung von <b>Tubeless-fähigen Reifen- und Felgensysteme</b></li> <li>zur Vermeidung von Reifenpannen</li> <li>dichtet kleine bis mittlere Durchstiche effektiv und dauerhaft ab</li> <li>ohne zu verklumpen</li> <li><b>vollständig biologisch abbaubar</b></li> <li>500 ml Flasche mit Ausgießer</li> </ul>	<b>SEALING LIQUID</b> ›MOTUL TUBELESS TIRE SEALANT‹ <ul style="list-style-type: none"> <li>allows an easy setup of <b>tubeless-ready tyre and rim systems</b></li> <li>for puncture prevention</li> <li>effectively and consistently seals small to medium punctures</li> <li>without clumping</li> <li><b>fully biodegradable</b></li> <li>500 ml bottle with nozzle</li> </ul>	<b>STEP 4: PREVENT</b> 
Exklusiv erhältlich in DE, AT, PL, CZ, SK. Andere Länder auf Anfrage.		Exclusively available in DE, AT, PL, CZ, SK. Other countries on request.	





M-WAVE  
›GUARD‹

## STAUB, SCHLAMM, SCHMUTZ?

Schütze dein Rad mit den Produkten der Pflegeserie GUARD. Die bereits seit 1991 speziell für Fahrräder entwickelten Pflegeprodukte haben sich weltweit bei professionellen Rennteams bewährt. Die hohe Qualität verlängert die Lebensdauer der Fahrradteile und sorgt für perfekten Leichtlauf.

- **Schmieren, Schützen, Entfetten – GUARD hat für alles die passende Lösung**
- **Produktion in der EU**
- **Höchste Qualität, die den Ansprüchen von Top-Athleten gerecht wird**

## DUST, MUD, DIRT?

Protect your bike with products from the GUARD bike care series. These special care products for bikes have been developed since 1991 and are used by professional racing teams worldwide. Their high quality extends the life time of your bicycle parts and ensures smooth operation.

- **Lubrication, protection, degreasing – GUARD has the right solution**
- **Production within the EU**
- **High quality which meets the requirements of top athletes**

## REINIGEN

## CLEAN

### FAHRRADREINIGER ›CLEAN GUARD‹

- besonders **reichhaltiger und gut haftender Schaum** zur intensiven Reinigung von starken Verschmutzungen wie Matsch, Fett und Öl
- leicht **biologisch abbaubar**
- sanft zu Lack und Oberfläche
- auch für Carbonrahmen geeignet
- Gebrauchsanweisung in BG, CS, DA, DE, EL, EN, ES, FI, FR, HR, HU, IT, NL, NO, PL, PT, RO, RU, SK, SL, SR, SV, TR, UA

**880750** 500 ml PE-Sprühflasche

12

**880751** 1000 ml Kanister zum Nachfüllen von Art. 880750

11

### BIKE CLEANER ›CLEAN GUARD‹

- extra **rich and maintaining foam** for intensive cleaning from mud, grease and oil
- readily **biodegradable**
- sensitive to coating and surface
- also suitable for carbon frames
- instruction manual in BG, CS, DA, DE, EL, EN, ES, FI, FR, HR, HU, IT, NL, NO, PL, PT, RO, RU, SK, SL, SR, SV, TR, UA

500 ml PE spray bottle

UVP 7,90 €

1000 ml canister to refill art. 880750

UVP 9,90 €



### 880778 SCHEIBENBREMSENREINIGER ›BRAKE GUARD‹

12

- leistungsstarker **Spezialreiniger für Scheibenbremsen**
- **entfernt** schnell und vollkommen rückstandsfrei Bremsstaub sowie alle **öl-, fett- und silikonhaltigen Verschmutzungen**
- mit Punktsprühkopf für gezielten Strahl
- Gebrauchsanweisung in BG, CS, DA, DE, EL, EN, ES, FI, FR, HR, HU, IT, NL, NO, PL, PT, RO, RU, SK, SL, SR, SV, TR, UA
- 400 ml Sprühdose

### DISC BRAKE CLEANER ›BRAKE GUARD‹

- high performance **special cleaner for disc brakes**
- **removes** quickly and entirely residue free brake dust, as well as **oil, grease and silicone soiling**
- with spray head for exact spraying
- instruction manual in BG, CS, DA, DE, EL, EN, ES, FI, FR, HR, HU, IT, NL, NO, PL, PT, RO, RU, SK, SL, SR, SV, TR, UA
- 400 ml spray tin

UVP 8,90 €





ART.-NR. BESCHREIBUNG

DESCRIPTION



## SCHMIEREN

## LUBRICATE

### KETTENPFLEGE ›CHAIN GUARD ULTRA‹

- sehr **gute Hafteigenschaft**
- Verschleiß- und Korrosionsschutz
- bei **trockenen und nassen** Bedingungen verwendbar
- Gebrauchsanweisung in BG, CS, DA, DE, EL, EN, ES, FI, FR, HR, HU, IT, NL, NO, PL, PT, RO, RU, SK, SL, SR, SV, TR, UA

**880765** 50 ml PE-Flasche

136

**880766** 200 ml Sprühdose, mit Punktsprühkopf für gezielten Strahl

12

### CHAIN CARE ›CHAIN GUARD ULTRA‹

- very **good adhesion**
- wear and corrosion protection
- to be used on **dry and wet** conditions
- instruction manual in BG, CS, DA, DE, EL, EN, ES, FI, FR, HR, HU, IT, NL, NO, PL, PT, RO, RU, SK, SL, SR, SV, TR, UA

50 ml PE bottle

UVP 5,90 €

200 ml spray tin, with spray head for exact spraying

UVP 10,90 €

2 IN 1: DRY AND WET



### SPEZIALÖL ›OIL GUARD BIODEGRADABLE‹

- **Universalöl** für alle beweglichen Teile am Fahrrad
- **gute Kriechwirkung** und Korrosionsschutz
- besonders geeignet für Seilzüge, Schaltwerke, ...
- leicht **biologisch abbaubar**
- Gebrauchsanweisung in BG, CS, DA, DE, EL, EN, ES, FI, FR, HR, HU, IT, NL, NO, PL, PT, RO, RU, SK, SL, SR, SV, TR, UA

**880760** 100 ml PE-Flasche

72

**880761** 200 ml Sprühdose  
• mit Punktsprühkopf für gezielten Strahl

12

### SPECIAL OIL ›OIL GUARD BIODEGRADABLE‹

- **universal oil** for all movable parts of the bicycle
- **good creep effect** and corrosion protection
- especially suitable for cables, derailleurs, ...
- readily **biodegradable**
- instruction manual in BG, CS, DA, DE, EL, EN, ES, FI, FR, HR, HU, IT, NL, NO, PL, PT, RO, RU, SK, SL, SR, SV, TR, UA

100 ml PE bottle

UVP 4,90 €

200 ml spray tin  
• with spray head for exact spraying

UVP 7,90 €



### SCHMIERMITTEL ›LUBE GUARD WHITE‹

- sehr **hochwertiges**, weißes **PTFE-Schmierfett**
- zum Schmieren von Lagern, Naben, Pedalen, ...
- schützt vor eindringendem Wasser und **verlängert die Lebensdauer** von Lagern
- Gebrauchsanweisung in BG, CS, DA, DE, EL, EN, ES, FI, FR, HR, HU, IT, NL, NO, PL, PT, RO, RU, SK, SL, SR, SV, TR, UA
- 125 ml Dose

**880779**

10

### LUBRICANT ›LUBE GUARD WHITE‹

- **high-quality**, white **PTFE lubricant**
- for the lubrication of bearings, hubs, pedals, ...
- excels in its high resistance against water and **provides a long life** for all bearings
- instruction manual in BG, CS, DA, DE, EL, EN, ES, FI, FR, HR, HU, IT, NL, NO, PL, PT, RO, RU, SK, SL, SR, SV, TR, UA
- 125 ml can

UVP 6,90 €



## MONTIEREN

## MOUNTING

### CARBON MONTAGEPASTE ›GREASE GUARD DIAMOND‹

- für Carbonteile
- auch geeignet für Stahl, Aluminium oder Titanteile in Kombination mit Carbon
- verhindert Verrutschen
- **niedrigere Klemmkräfte** (Drehmoment) reichen für gute Verbindung
- **leichteres Lösen** der Verbindung möglich
- Gebrauchsanweisung in DE, EN, ES, FR, NL
- 125 ml Dose

**880780**

45

### CARBON GRIP PASTE ›GREASE GUARD DIAMOND‹

- for carbon parts
- also suitable for steel, aluminium or titanium parts in combination with carbon
- prevents slipping
- **low clamping force** (torque) is enough for good connection
- connection **easily resolvable**
- instruction manual in DE, EN, ES, FR, NL
- 125 ml can

UVP 14,90 €



ART.-NR. 	BESCHREIBUNG	DESCRIPTION		
SCHUTZ UND KONSERVIERUNG			PROTECTION AND CONSERVATION	
<b>880770</b> 12	<b>SPRÜHWACHS ›WAX GUARD‹</b> <ul style="list-style-type: none"> <li>• erneuert und <b>schützt Oberflächen</b></li> <li>• frischt die Farbe auf und begrenzt die Schmutzablagerung</li> <li>• verlängert die Lebensdauer</li> <li>• universell einsetzbar für Metall, Carbon, Gummi, Glattleder, Synthetik ...</li> <li>• Gebrauchsanweisung in BG, CS, DA, DE, EL, EN, ES, FI, FR, HR, HU, IT, NL, NO, PL, PT, RO, RU, SK, SL, SR, SV, TR, UA</li> <li>• 200 ml Sprühdose</li> </ul>	<b>SPRAY WAX ›WAX GUARD‹</b> <ul style="list-style-type: none"> <li>• renews and <b>protects surfaces</b></li> <li>• refreshes colours and limits deposition of dirt</li> <li>• increases lifetime</li> <li>• for metal, carbon, rubber, smooth leather, synthetic ...</li> <li>• instruction manual in BG, CS, DA, DE, EL, EN, ES, FI, FR, HR, HU, IT, NL, NO, PL, PT, RO, RU, SK, SL, SR, SV, TR, UA</li> <li>• 200 ml spray tin</li> </ul>	 <p style="text-align: right;">UVP 6,90 €</p>	
<b>880775</b> 12	<b>SILIKONSPRAY ›SILICONE GUARD‹</b> <ul style="list-style-type: none"> <li>• <b>schmiert, pflegt und konserviert Kontaktflächen von Kunststoff, Gummi und Metall</b></li> <li>• beseitigt Knarr- und Quietschgeräusche</li> <li>• besonders für <b>Federgabeln</b> geeignet</li> <li>• mit Punktsprühkopf für gezielten Strahl</li> <li>• Gebrauchsanweisung in BG, CS, DA, DE, EL, EN, ES, FI, FR, HR, HU, IT, NL, NO, PL, PT, RO, RU, SK, SL, SR, SV, TR, UA</li> <li>• 400 ml Sprühdose</li> </ul>	<b>SILICONE SPRAY ›SILICONE GUARD‹</b> <ul style="list-style-type: none"> <li>• <b>lubricates, maintains and conserves contact surfaces of plastic, rubber and metal</b></li> <li>• removes creaking and squeaking noises</li> <li>• especially for <b>suspension forks</b></li> <li>• with spray head for exact spraying</li> <li>• instruction manual in BG, CS, DA, DE, EL, EN, ES, FI, FR, HR, HU, IT, NL, NO, PL, PT, RO, RU, SK, SL, SR, SV, TR, UA</li> <li>• 400 ml spray tin</li> </ul>	  <p style="text-align: right;">UVP 9,90 €</p>	
PFLEGESET			CARE SET	
<b>880785</b> 12 set	<b>FAHRRAD PFLEGESET ›GUARD TEAM‹</b> <ul style="list-style-type: none"> <li>• bestehend aus: <b>Fahrradreiniger ›Clean Guard‹</b> (Art. 880750) <b>Sprühwachs ›Wax Guard‹</b> (Art. 880770) <b>Kettenpflege ›Chain Guard Ultra‹</b> (Art. 880765) <b>Spezialöl ›Oil Guard Bio‹</b> (Art. 880760)</li> <li>• Gebrauchsanweisung in BG, CS, DA, DE, EL, EN, ES, FI, FR, HR, HU, IT, NL, NO, PL, PT, RO, RU, SK, SL, SR, SV, TR, UA</li> <li>• in M-Wave Eurolochbox</li> </ul>	<b>BICYCLE CARE SET ›GUARD TEAM‹</b> <ul style="list-style-type: none"> <li>• consisting of: <b>Bike cleaner ›Clean Guard‹</b> (art. 880750) <b>Spray wax ›Wax Guard‹</b> (art. 880770) <b>Chain care ›Chain Guard Ultra‹</b> (art. 880765) <b>Special oil ›Oil Guard Bio‹</b> (art. 880760)</li> <li>• instruction manual in BG, CS, DA, DE, EL, EN, ES, FI, FR, HR, HU, IT, NL, NO, PL, PT, RO, RU, SK, SL, SR, SV, TR, UA</li> <li>• in M-Wave eurohole box</li> </ul>	 <p>Art. 880750 Art. 880770 Art. 880765 Art. 880760</p> <p style="text-align: right;">UVP 26,90 €</p>	



**SUPER B**<sup>®</sup>  
tool excellence

Seit über 30 Jahren baut Super B hochwertige Werkzeuge, seit über 20 Jahren Fahrradwerkzeuge. Vergleichsweise jung, ist Super B trotzdem unter den renommierten Marken etabliert. Inzwischen vertrauen auch PRO TOUR-Fahrer und Mechaniker auf Super B.





Als Vollsortimenter im Bereich Fahrradwerkzeuge bietet Super B mit „Premium“ und „Classic“ zwei Produktlinien für Pro- und Hobbybenutzer an. Sie erfüllen bei unterschiedlicher Preisgestaltung alle Schrauberwünsche.

30 years ago, Super B started to build high value tools and over 20 years ago bicycle tools. Although being quite young, Super B managed to establish themselves among the renowned brands. Meanwhile, PRO TOUR rider and mechanics also rely on Super B.

As a full-range supplier of bicycle tools, Super B offers with „Premium“ and „Classic“ two product lines for professional and hobby users. With different pricing, they satisfy all mechanics' wishes.



ART.-NR. 	BESCHREIBUNG	DESCRIPTION	
	<p><b>PREMIUM WERKZEUG</b></p> <p><b>Super B Premium</b> Werkzeuge werden ausschließlich aus <b>hochwertigsten Materialien</b> unter Anwendung modernster Technologie gefertigt. <b>Höchste Präzision</b>, angenehme <b>Griffe</b> und <b>edles Finish</b> sind die beste Empfehlung für den Einsatz in <b>Profi-Fahrradwerkstätten</b>.</p>	<p><b>PREMIUM TOOLS</b></p> <p><b>Super B Premium</b> tools are manufactured with nothing but the <b>best materials</b> by using the latest technology. <b>Highest precision</b>, comfortable <b>grips</b> and <b>classy finish</b> are the best recommendation for using them in <b>professional bicycle garages</b>.</p>	
<p><b>881050</b></p> <p>1</p>	<p><b>WERKSTATTWAGEN ›TBA-9000‹</b></p> <ul style="list-style-type: none"> <li>• mehr <b>Flexibilität</b> bei Reparaturen, z.B. bei Platzmangel in der Werkstatt, Kundenservice vor Ort, für Messen und Events, ...</li> </ul> <p><b>Fach A1:</b></p> <ul style="list-style-type: none"> <li>• TB-FW20 Zahnkranzpeitsche (12-fach)</li> <li>• TB-HB50 Hakenschlüssel</li> <li>• TB-BB10 Innenlagerschlüssel</li> <li>• TB-CP15 Kassetten und Innenlagerschlüssel (für Campagnolo)</li> <li>• TB-BB30 Innenlagerschlüssel (für Shimano)</li> <li>• TB-8911 Tretkurbel-Montagewerkzeug</li> <li>• TB-FW30 Freilauf-Abzieher mit Haltepin</li> </ul> <p><b>Fach A2:</b></p> <ul style="list-style-type: none"> <li>• 7305-7345 T-Griff Innensechskant Schlüssel: 2/2,5/3/4/5/6/8/10 mm (rundes und gerades Ende)</li> </ul> <p><b>Fach B1:</b></p> <ul style="list-style-type: none"> <li>• ZB-03-A 12" einstellbarer Schraubenschlüssel</li> <li>• TB-1005 Innenlagerschlüssel</li> <li>• TB-1045 Freilaufabzieher</li> <li>• TB-1020 Freilaufabzieher</li> <li>• TB-1095 Freilaufabzieher</li> <li>• TB-1060 Innenlagerwerkzeug</li> <li>• TB-1065 Innenlagerwerkzeug</li> <li>• TB-7253 1/2" Antrieb H10 für Campagnolo</li> <li>• 8208-15 Maulschlüsselset 8-15 mm</li> </ul> <p><b>Fach B2:</b></p> <ul style="list-style-type: none"> <li>• TB-BB20 Innenlager-Hakenschlüssel</li> <li>• TB-WR10 Bremsenschlüssel 8/10 mm</li> <li>• TB-WR11 Bremsenschlüssel 9/11 mm</li> <li>• TB-HS30 Steuersatzschlüssel 30/32 mm</li> <li>• TB-HB32 Steuersatzschlüssel 15/32 mm</li> <li>• TB-HB36 Steuersatzschlüssel 15/36 mm</li> <li>• TB-HS40 Steuersatzschlüssel 36/40 mm</li> </ul> <p><b>Fach C1:</b></p> <ul style="list-style-type: none"> <li>• TB-PD10 Pedalschlüssel 15 mm</li> <li>• TB-MW50 Multifunktionspedalschlüssel</li> <li>• TB-TH10 Dreifach-T-Griff Vielzahn-schlüssel 25/30/40</li> <li>• TB-TH20 Dreifach-T-Griff Vielzahn-schlüssel 40/Innensechskant 6 mm/ Kettenblattschrauben</li> <li>• TB-CR10 2in1 Kurbelabzieher</li> <li>• TB-YY05 Y-Innensechskantschlüssel 2/2,5/3 mm</li> <li>• TB-YY10 Y-Schlüssel Vielzahn-schlüssel 25/30/40</li> <li>• TB-YY15 Y-Innensechskantschlüssel 4/5/6 mm</li> <li>• TB-TH30- Innensechskant-Schlüsselset 2/2,5/4/5/6/8/10 mm (langes Ende mit Kugelkopf)</li> </ul> <p><b>Fach C2:</b></p> <ul style="list-style-type: none"> <li>• TB-MW40 Bremsscheibenzentrierzange</li> <li>• TB-8912 Innenlagerschlüssel für Campagnolo</li> <li>• TB-HB13-19 Nabenmaulschlüssel flach 13-19 mm</li> </ul>	<p><b>WORKSTATION ›TBA-9000‹</b></p> <ul style="list-style-type: none"> <li>• more <b>flexibility</b> with repairs, e.g. if you have not enough space in the workshop, for on-site customer service, shows, events, ... UVP 4.998,00 €</li> </ul> <p><b>Case A1:</b></p> <ul style="list-style-type: none"> <li>• TB-FW20 freewheel turner (12 speed)</li> <li>• TB-HB50 multi hook</li> <li>• TB-BB10 b.b. wrench</li> <li>• TB-CP15 b.b. and cassette lock rings (for Campagnolo)</li> <li>• TB-BB30 cartridge b.b. tool (Shimano)</li> <li>• TB-8911 crank installation tool</li> <li>• TB-FW30 freewheel remover with center pin</li> </ul> <p><b>Case A2:</b></p> <ul style="list-style-type: none"> <li>• 7305-7345 T-shape hex key wrench size: 2/2.5/3/4/5/6/8/10 mm (ball and straight end)</li> </ul> <p><b>Case B1:</b></p> <ul style="list-style-type: none"> <li>• ZB-03-A 12"- adjustable wrench</li> <li>• TB-1005 b.b. wrench</li> <li>• TB-1045 freewheel remover</li> <li>• TB-1020 freewheel remover</li> <li>• TB-1095 freewheel remover</li> <li>• TB-1060 cartridge b.b. tool</li> <li>• TB-1065 cartridge b.b. tool</li> <li>• TB-7253 1/2" dr. bit socket H10 for Campagnolo</li> <li>• 8208-15 open wrenches, size 8-15 mm</li> </ul> <p><b>Case B2:</b></p> <ul style="list-style-type: none"> <li>• TB-BB20 b.b. hook tool</li> <li>• TB-WR10 brake wrench 8/10 mm</li> <li>• TB-WR11 brake wrench 9/11 mm</li> <li>• TB-HS30 headset wrench 30/32 mm</li> <li>• TB-HB32 headset wrench 15/32 mm</li> <li>• TB-HB36 headset wrench 15/36 mm</li> <li>• TB-HS40 headset wrench 36/40 mm</li> </ul> <p><b>Case C1:</b></p> <ul style="list-style-type: none"> <li>• TB-PD10 pedal wrench 15 mm</li> <li>• TB-MW50 multi-function pedal wrench</li> <li>• TB-TH10 T-shaped wrench star screwdriver 25/30/40</li> <li>• TB-TH20 multi wrench star screwdriver 40/hex 6 mm/chainring screws</li> <li>• TB-CR10 2-in-1 cotterless crank tool</li> <li>• TB-YY05 Y wrench hex 2/2.5/3 mm</li> <li>• TB-YY10 Y wrench star screwdriver 25/30/40</li> <li>• TB-YY15 Y wrench hex 4/5/6 mm</li> <li>• TB-TH30 hex wrench set 2/2.5/4/5/6/8/10 mm (long end with ball-shaped head)</li> </ul> <p><b>Case C2:</b></p> <ul style="list-style-type: none"> <li>• TB-MW40 rotor truing fork</li> <li>• TB-8912 cartridge b.b. tool for Campagnolo</li> <li>• TB-HB13-19 hub cone spanner flat sizes 13-19 mm</li> </ul>	<p><b>ALL in 1</b></p> <p>A1   A2</p> <p>B1   B2</p> <p>C1   C2</p>

ART.-NR.	BESCHREIBUNG	DESCRIPTION	
	<p><b>Fach D1:</b></p> <ul style="list-style-type: none"> <li>• TB-1901 Gewindebohrer 3 mm x 0,5</li> <li>• TB-1902 Gewindebohrer 5 mm x 0,8</li> <li>• TB-1903 Gewindebohrer 6 mm x 1.0</li> <li>• TB-1904 Gewindebohrer 10 mm x 1.0</li> <li>• TB-1905 L&amp;R Gewindebohrer 1/2" x 20</li> <li>• TB-1906 L&amp;R Gewindebohrer 9/16" x 20</li> <li>• TB-CC30 Kettennietdrücker</li> <li>• TB-CC40 Kettennietdrücker</li> <li>• TB-3370 Kettennietdrücker</li> <li>• TB-3326 2 in 1 Kettenschleife/Haken</li> <li>• TB-WC30 Kabelzange</li> <li>• TB-4585 Kabelhalter</li> <li>• TB-1103 Ersatzpins für Super B Kettennietdrücker</li> </ul> <p><b>Fach D2:</b></p> <ul style="list-style-type: none"> <li>• TB-7518 Kreuzschraubendreher, Länge 75 mm</li> <li>• TB-7528 Kreuzschraubendreher, Länge 100 mm</li> <li>• TB-7538 Schlitzschraubendreher Länge 75 mm</li> <li>• TB-7548 Schlitzschraubendreher Länge 100 mm</li> <li>• TB-5540 Speichenschlüssel 0,127"</li> <li>• TB-5550 Speichenschlüssel 0,130"</li> <li>• TB-5560 Speichenschlüssel 0,136"</li> <li>• TB-5596 Speichenschlüssel Mavic</li> <li>• TB-5501 Aero-Speichenschlüssel 0,9/1,1/1,3/1,9 mm</li> <li>• TB-TL20 Profi-Reifenheber 2 Stück</li> <li>• TB-5517 Speichenschlüssel 4,3 x 4,4 mm</li> <li>• TB-5518 Speichenschlüssel Mavic</li> <li>• TB-7811 Speichenschlüssel Hex 4,8 mm</li> <li>• TB-7812 Speichenschlüssel Hex 5,5 mm</li> <li>• TB-7814 Speichenschlüssel Vierkant 3,2 mm</li> <li>• TB-7815 Schlitznippeldreher mit Pin</li> <li>• TB-5568 Reifenheber 2 Stück</li> </ul>	<p><b>Case D1:</b></p> <ul style="list-style-type: none"> <li>• TB-1901 frame taps 3 mm x 0.5</li> <li>• TB-1902 frame taps 5 mm x 0.8</li> <li>• TB-1903 frame taps 6 mm x 1.0</li> <li>• TB-1904 frame taps 10 mm x 1.0</li> <li>• TB-1905 l&amp;r pedal taps 1/2" x 20</li> <li>• TB-1906 l&amp;r pedal taps 9/16" x 20</li> <li>• TB-CC30 chain rivet extractor</li> <li>• TB-CC40 chain rivet extractor</li> <li>• TB-3370 chain rivet extractor</li> <li>• TB-3326 2 in 1 chain checker and chain hook function</li> <li>• TB-WC30 professional cable cutter</li> <li>• TB-4585 inner cable puller</li> <li>• TB-1103 replacement pins for Super B chain rivet extractor</li> </ul> <p><b>Case D2:</b></p> <ul style="list-style-type: none"> <li>• TB-7518 screwdriver Phillips, length 75 mm</li> <li>• TB-7528 screwdriver Phillips, length 100 mm</li> <li>• TB-7538 screwdriver slotted, length 75 mm</li> <li>• TB-7548 screwdriver slotted, length 100 mm</li> <li>• TB-5540 spoke wrench 0.127"</li> <li>• TB-5550 spoke wrench 0.130"</li> <li>• TB-5560 spoke wrench 0.136"</li> <li>• TB-5596 spoke wrench Mavic</li> <li>• TB-5501 aero spoke key 0.9/1.1/1.3/1.9 mm</li> <li>• TB-TL20 professional tire lever 2 pcs</li> <li>• TB-5517 spoke wrench 4.3 x 4.4 mm</li> <li>• TB-5518 Mavic spoke wrench</li> <li>• TB-7811 nipple tools hex 4.8 mm</li> <li>• TB-7812 nipple tools hex 5.5 mm</li> <li>• TB-7814 nipple tools square 3.2 mm</li> <li>• TB-7815 slit wrench with pin</li> <li>• TB-5568 tire lever 2 pcs</li> </ul>	 <p>D1   D2</p>  <p>E1   E2</p>
	<p><b>Fach E1:</b></p> <ul style="list-style-type: none"> <li>• TB-1130 Aheadkrallenmontagewerkzeug 1" &amp; 1 1/8"</li> <li>• TB-1100 Kunststoffhammer</li> <li>• TB-1108 Maßband</li> <li>• TB-1162 Speichenlineal</li> <li>• TB-1169 Rohrabstschneidehilfe</li> <li>• TB-1925 Gabelkonusabzieher</li> <li>• TB-8075 hydraulische Bremsattelpresse</li> </ul> <p><b>Fach E2:</b></p> <ul style="list-style-type: none"> <li>• TB-3208 Kettenreinigungsgerät</li> <li>• TB-1708 Reinigungsbürste</li> <li>• TB-1709 Reinigungsbürste</li> <li>• TB-1710 Reinigungsbürste</li> <li>• TB-1711 Reinigungs-/Faltbürste</li> </ul>	<p><b>Case E1:</b></p> <ul style="list-style-type: none"> <li>• TB-1130 star nut setter 1" &amp; 1 1/8"</li> <li>• TB-1100 dead blow hammer</li> <li>• TB-1108 measure tape</li> <li>• TB-1162 spoke, bearing and crank cotter gauge</li> <li>• TB-1169 oversized tube cutting guide</li> <li>• TB-1925 crown race remover</li> <li>• TB-8075 hydraulic brake piston press</li> </ul> <p><b>Case E2:</b></p> <ul style="list-style-type: none"> <li>• TB-3208 chain cleaner</li> <li>• TB-1708 bike cleaning brush</li> <li>• TB-1709 bike cleaning brush</li> <li>• TB-1710 bike cleaning brush</li> <li>• TB-1711 bike folding brush</li> </ul>	 <p>F</p>
	<p><b>Fach F:</b></p> <ul style="list-style-type: none"> <li>• TB-1930 Laufradlehre</li> <li>• TB-1161 Eisensäge</li> <li>• TB-1161A Wechselsägeblatt zum Carbon sägen</li> <li>• TB-TW20 1/4"- Drehmomentschlüssel 3-15 Nm &amp; Bit-Set</li> <li>• TB-4515 6" Seitenschneider</li> <li>• TB-4520-1 8" Kombizange lang</li> <li>• TB-4525-1 10" Wasserpumpenzange</li> </ul>	<p><b>Case F:</b></p> <ul style="list-style-type: none"> <li>• TB-1930 wheel alignment gauge</li> <li>• TB-1161 hacksaw</li> <li>• TB-1161A replacement blade for cutting carbon</li> <li>• TB-TW20 1/4" torque wrench 3-15 Nm &amp; bit socket set</li> <li>• TB-4515 6" diagonal cutting nippers</li> <li>• TB-4520-1 8" long nose pliers</li> <li>• TB-4525-1 10" water pump box joint</li> </ul>	 <p>G</p>
	<p><b>Fach G:</b></p> <ul style="list-style-type: none"> <li>• TB-1935 Steuersatzmontagewerkzeug</li> <li>• TB-1310 Mechanikerschürze</li> <li>• TB-1936 Steuersatzaustreiber</li> <li>• TB-TW30 3/8"- Drehmomentschlüssel 12-16 Nm &amp; Bit-Set</li> </ul>	<p><b>Case G:</b></p> <ul style="list-style-type: none"> <li>• TB-1935 bearing cup press</li> <li>• TB-1310 heavy duty shop apron</li> <li>• TB-1936 head cup remover</li> <li>• TB-TW30 3/8" torque wrench 12-16 Nm &amp; bit socket set</li> </ul>	



ART.-NR. 	BESCHREIBUNG	DESCRIPTION	
<b>880062</b> 1	<b>OPTIONALES ZUBEHÖR WERKSTATTWAGEN 99000</b>  <b>MONTAGESTÄNDER ›TB-1971‹</b> <ul style="list-style-type: none"> <li>zur Montage am Werkstattwagen Art. 881050</li> <li><b>Klemme drehbar</b> mit Schnellverschlüssen</li> <li>Ersatzklemmeinsatz = Art. 881043</li> <li>universell auf Rohrdurchmesser <b>einstellbar</b></li> <li>im Super B Einzelkarton</li> </ul>	<b>OPTIONAL ACCESSORIES WORKSTATION 99000</b>  <b>ASSEMBLY STAND ›TB-1971‹</b> <ul style="list-style-type: none"> <li>for mounting on workstation art. 881050</li> <li><b>clamp turnable</b> with QRs</li> <li>replacement clamp = art. 881043</li> <li>universally <b>adjustable</b> to tube diameter</li> <li>in Super B box</li> </ul> <p style="text-align: right;">UVP 223,00 €</p>	
<b>881056</b> 20	<b>SCHRAUBSTOCKEINSATZ ›TB-8645‹</b> <ul style="list-style-type: none"> <li><b>Aluminium-Achshalter</b> für Reparaturen an Naben, Pedalen, ...</li> <li><b>schont Gewinde</b> und <b>Achsen</b></li> <li>durch Sprungfeder hält der Einsatz im Schraubstock von selbst</li> <li>passend für alle <b>Standard-Schraubstöcke</b></li> <li>mit Bohrungen für <math>\varnothing S</math> (= ca. 9 mm), <math>\varnothing M</math> (= ca. 10 mm), <math>\varnothing L</math> (= ca. 12 mm) Nabenachsen und <b>9/16"</b> Pedalgewinde</li> <li>im Super B Einzelkarton</li> </ul>	<b>WISE INSERT ›TB-8645‹</b> <ul style="list-style-type: none"> <li><b>aluminium axle retainer</b> for repairing hubs, pedals, ...</li> <li><b>protects threads</b> and <b>axles</b></li> <li>the bridge spring keeps the insert in the vise automatically</li> <li>suits for all <b>standard vises</b></li> <li>with holes for <math>\varnothing S</math> (= approx. 9 mm), <math>\varnothing M</math> (= approx. 10 mm), <math>\varnothing L</math> (= approx. 12 mm) hub axles and <b>9/16"</b> pedal threads</li> <li>in Super B box</li> </ul> <p style="text-align: right;">UVP 29,90 €</p>	  
<b>880075</b> 4	<b>WAND-/WERKBANK-MONTAGESTÄNDER ›TB-WS 35‹</b> <ul style="list-style-type: none"> <li><b>professioneller</b> und <b>äußerst robuster</b> Montageständer</li> <li>kann an eine <b>Wand</b> oder auf eine <b>Werkbank</b> fest montiert werden</li> <li><b>stabile Schnellverschlussklemme</b> mit <b>Verkratzschutz</b> (Ersatzinsert = Art. 881043), universell einstellbar auf Rohrdurchmesser</li> <li><b>360° drehbar</b> mit Schnellverschluss</li> <li><b>Schwenkarm horizontal</b> in 3 Positionen (0°-90°-180°) <b>arretierbar</b></li> <li>inkl. Befestigungsschrauben</li> <li>im Super B Einzelkarton</li> </ul>	<b>WALL/WORKBENCH STAND ›TB-WS 35‹</b> <ul style="list-style-type: none"> <li><b>professional</b> and <b>extremely robust</b> work stand</li> <li>can be fixed at a <b>wall</b> or on a <b>workbench</b></li> <li><b>firm QR clamp</b> with <b>scratch protection</b> (replacement insert = art. 881043), universally adjustable to tube diameter</li> <li><b>360° turnable</b> with quick release</li> <li><b>pivot arm horizontally lockable</b> in 3 positions (0°-90°-180°)</li> <li>incl. mounting screws</li> <li>in Super B box</li> </ul> <p style="text-align: right;">UVP 169,90 €</p>	
<b>880071</b> 2	<b>ZENTRIERSTÄNDER ›TB-PF 30‹</b> <ul style="list-style-type: none"> <li>professioneller Zentrierständer für <b>höchste Präzision</b></li> <li>für <b>12"-29"</b> Laufräder</li> <li>auch für Boost, Plus, ... Laufräder geeignet durch Öffnungsbreite bis 165 mm</li> <li>mit <b>zwei analogen Messuhren</b> mit einer <b>Genauigkeit von 0,01 mm</b></li> <li><b>maximale Flexibilität</b> bei der Messung durch <b>frei verstellbare, extra lange Messarme</b> (Art. 880171)</li> <li>auch zur <b>Seitenschlagmessung von Bremsscheiben</b> geeignet</li> <li>inkl. <b>Steckachsadaptern</b> für 15 und 20 mm Achsen</li> <li>an der Werkbank fest montierbar</li> <li>im Super B Einzelkarton</li> </ul>	<b>TRUING STAND ›TB-PF 30‹</b> <ul style="list-style-type: none"> <li>professional truing stand for <b>highest precision</b></li> <li>for <b>12"-29"</b> wheels</li> <li>also suitable for Boost, Plus, ... wheel sets by opening width up to 165 mm</li> <li>with <b>two analogue dial indicators</b> with <b>0.01 mm tolerance</b></li> <li><b>maximum flexibility</b> for measuring through <b>all-purpose, extra long and easy to adjust indicator arms</b> (art. 880171)</li> <li>also usable for <b>truing brake discs</b></li> <li>incl. <b>adapters</b> for 15 and 20 mm thru axles</li> <li>can be fixed at the workbench</li> <li>in Super B box</li> </ul> <p style="text-align: right;">UVP 749,00 €</p>	<div style="border: 1px solid black; padding: 5px; display: inline-block;"><b>BOOST ✓</b></div>    



ART.-NR. 	BESCHREIBUNG	DESCRIPTION	
<b>880167</b> 5	<b>SPEICHENSPANNUNGS-MESSGERÄT ›TB-ST11‹</b> <ul style="list-style-type: none"> <li>mit <b>Präzisionsmessuhr</b> für den professionellen Laufradbau</li> <li>im Super B Einzelkarton</li> </ul>	<b>SPOKE TENSIO METER ›TB-ST11‹</b> <ul style="list-style-type: none"> <li>with <b>high precision dial gauge</b> for professional wheel building</li> <li>in Super B box</li> </ul>	 
<b>880355</b> 100	<b>NIPPELDREHER ›TB-7816‹</b> <ul style="list-style-type: none"> <li>ermöglicht ein <b>einfaches</b> und <b>schnelles Einspeichen</b></li> <li>mit Ersatzfeder</li> <li>auf Super B Eurolochkarte</li> </ul>	<b>NIPPLE DRIVER ›TB-7816‹</b> <ul style="list-style-type: none"> <li>provides an <b>easy</b> and <b>fast wheel set manufacturing</b></li> <li>with replacement spring</li> <li>on Super B eurohole card</li> </ul>	 
<b>880348</b> 200/50	<b>SPEICHENSCHLÜSSEL ›TB-SW 20‹</b> <ul style="list-style-type: none"> <li>aus <b>präzise</b>m, <b>gehärtetem CrMo-Stahl</b></li> <li><b>sehr gute Kraftübertragung</b></li> <li>für 3,2 mm Nippel (14G)</li> <li>auf Super B Eurolochkarte</li> </ul>	<b>SPOKE WRENCH ›TB-SW 20‹</b> <ul style="list-style-type: none"> <li>made of <b>precise hardened CrMo steel</b></li> <li><b>very good power transfer</b></li> <li>for 3.2 nipples (14G)</li> <li>on Super B eurohole card</li> </ul>	 
<b>880027</b> 5 set	<b>GABELSCHAFT-SCHNEIDEWerkZEUG ›TB-19454‹</b> <ul style="list-style-type: none"> <li>Präzisionsschneidewerkzeug aus <b>hochwertigem HSS-Stahl</b></li> <li><b>1" - 24 TPI</b> und <b>1 1/8" - 26 TPI Schneideeinsätze</b></li> <li>inkl. 1" und 1 1/8" Führungshilfe</li> <li>im Super B Einzelkarton</li> </ul>	<b>FORK SHAFT THREADING TOOL ›TB-19454‹</b> <ul style="list-style-type: none"> <li><b>high quality HSS steel</b> precision cutter tool</li> <li><b>1" - 24 TPI</b> and <b>1 1/8" - 26 TPI cutters</b></li> <li>incl. 1" and 1 1/8" guide</li> <li>in Super B box</li> </ul>	  
<b>880219</b> 6	<b>GABELKONUSABZIEHER ›TB-1926‹</b> <ul style="list-style-type: none"> <li>für 1", 1 1/8", 1 1/4", 1,5"</li> <li>im Super B Einzelkarton</li> </ul>	<b>HEAD SET CONE REMOVER ›TB-1926‹</b> <ul style="list-style-type: none"> <li>for 1", 1 1/8", 1 1/4", 1,5"</li> <li>in Super B box</li> </ul>	 

ART.-NR. 	BESCHREIBUNG	DESCRIPTION	
<b>880029</b> 5 set	<b>TRETLAGER - SCHNEIDWERKZEUG ›TB-98150‹</b> <ul style="list-style-type: none"> <li>• <b>Präzisionswerkzeug</b> zum <b>Planfräsen</b> der Lagersitze und <b>Nachschneiden</b> der Innenlagergewinde</li> <li>• Fräswerkzeug mit <b>Führungshülsen</b> zum präzisen Ansetzen</li> <li>• Gewindeschneider für <b>BSA-Gewinde</b> 1,370" x 24 TPI (links und rechts)</li> <li>• inkl. Bürste zum Reinigen</li> <li>• im hochwertigen Koffer</li> </ul>	<b>BOTTOM BRACKET CUTTING TOOL ›TB-98150‹</b> <ul style="list-style-type: none"> <li>• <b>precision tool</b> for <b>face milling</b> the bearing seats and <b>tapping</b> the bottom bracket thread</li> <li>• milling tool with <b>guides</b> for accurate collaring</li> <li>• thread tapping tool for <b>BSA thread</b> 1.370" x 24 TPI (left and right)</li> <li>• incl. brush for cleaning</li> <li>• in high quality case</li> </ul>	<p style="text-align: right;">UVP 431,00 €</p>
<b>881012</b> 10 set	<b>INNENLAGER-EINPRESSWERKZEUG ›TB-1900B‹</b> <ul style="list-style-type: none"> <li>• schwere hochwertige Ausführung</li> <li>• für die einfache und <b>genaue</b> Montage von <b>Press Fit-Innenlagern</b></li> <li>• mit 3 x 2 Einsätzen für <b>BB 30, BB 86/92</b> und <b>BB 90 (für 30 und 24 mm Achse)</b></li> <li>• Griffe abnehmbar</li> <li>• im Super B Einzelkarton</li> </ul>	<b>BOTTOM BRACKET PRESS IN TOOL ›TB-1900B‹</b> <ul style="list-style-type: none"> <li>• heavy duty and high quality</li> <li>• for easy and <b>accurate</b> installation of <b>press fit bottom brackets</b></li> <li>• with 3 x 2 adapters for <b>BB 30, BB 86/92</b> and <b>BB 90 (for 30 and 24 mm axle)</b></li> <li>• handles detachable</li> <li>• in Super B box</li> </ul>	<p style="text-align: right;">UVP 99,90 €</p>
	<b>INNENLAGER – DEMONTAGE-WERKZEUG</b> <ul style="list-style-type: none"> <li>• zur einfachen Demontage von <b>Press Fit-Innenlagern</b></li> <li>• Lagerschalen werden von der Gegenseite mit Hammer herausgeschlagen</li> <li>• <b>schonend</b> durch große Auflagefläche</li> <li>• im Super B Einzelkarton</li> </ul>	<b>BOTTOM BRACKET REMOVING TOOL</b> <ul style="list-style-type: none"> <li>• for easy removal of <b>press fit bottom brackets</b></li> <li>• the bearing cups are knocked out from the opposite side with a hammer</li> <li>• operating almost <b>without wear</b> by wide contact area</li> <li>• in Super B box</li> </ul>	
<b>881010</b>	<b>›TB-1927A‹</b> für BB 86/90/92/95, PF 30 (24 mm Achse), ...	<b>›TB-1927A‹</b> for BB 86/90/92/95, PF 30 (24 mm axle), ...	<p style="text-align: right;">UVP 30,90 €</p>
<b>881011</b>	<b>›TB-1928A‹</b> für BB 30, PF 30, BB OS, BB Right, BB 386 Evo (30 mm Achse), ...	<b>›TB-1928A‹</b> for BB 30, PF 30, BB OS, BB Right, BB 386 Evo (30 mm axle), ...	<p style="text-align: right;">UVP 34,90 €</p>

ART.-NR.	BESCHREIBUNG	DESCRIPTION	
<b>881005</b> 50	<b>INNENLAGERSCHLÜSSEL</b> <b>›TB-BB 10‹</b> <ul style="list-style-type: none"> <li>zum (De-)Montieren von Shimano Hollowtech II, Truvativ, FSA MegaExo, Giga X-Pipe, Campagnolo UltraTorque und anderen außenliegenden Innenlagerschalen</li> <li><b>aufgesetzter Minischlüssel</b> (8-Zahn) für die Lagerschalenverschlusskappen</li> <li>weicher und <b>rutschfester 2-Komponentengriff</b></li> <li>auf Super B Eurolochkarte</li> </ul>	<b>BOTTOM BRACKET WRENCH</b> <b>›TB-BB 10‹</b> <ul style="list-style-type: none"> <li>for (de-)mounting Shimano Hollowtech II, Truvativ, FSA MegaExo, Giga X-Pipe, Campagnolo UltraTorque and other outer bearing cups</li> <li><b>attached mini tool</b> (8-teeth) for axle cover lids</li> <li>soft <b>non-slip two-component grip</b></li> <li>on Super B eurohole card</li> </ul> <p style="text-align: right;">UVP 27,90 €</p>	
<b>880077</b> 50	<b>INNENLAGERWERKZEUG</b> <b>›TB-BB30‹</b> <ul style="list-style-type: none"> <li>für Shimano Innenlager</li> <li>mit <b>Pin zur besseren Fixierung</b> in der Kurbelarmschraubengewindebohrung</li> <li>weicher und <b>rutschfester 2-Komponentengriff</b></li> <li>auf Super B Eurolochkarte</li> </ul>	<b>BOTTOM BRACKET TOOL</b> <b>›TB-BB30‹</b> <ul style="list-style-type: none"> <li>for Shimano bottom bracket</li> <li>with <b>pin for better fixation</b> in the crankarm screw hole</li> <li>soft <b>non-slip two-component grip</b></li> <li>on Super B eurohole card</li> </ul> <p style="text-align: right;">UVP 28,90 €</p>	
<b>880560</b> 100	<b>INNENLAGERSCHLÜSSEL</b> <b>›TB-BB 20‹</b> <ul style="list-style-type: none"> <li><b>2 in 1</b></li> <li>ein- und 3-fach Hakenschlüssel für <b>Konterring</b> von <b>Schraubschalen</b> und (1-fach) <b>Zahnkränzen</b> (z. B. bei Single-speednaben)</li> <li>auf Super B Eurolochkarte</li> </ul>	<b>BOTTOM BRACKET WRENCH</b> <b>›TB-BB 20‹</b> <ul style="list-style-type: none"> <li><b>2 in 1</b></li> <li>single and triple hook wrench for <b>counter ring of thread cups</b> and (1-speed) <b>sprockets</b> (e. g. at single speed hubs)</li> <li>on Super B eurohole card</li> </ul> <p style="text-align: right;">UVP 23,90 €</p>	
<b>880558</b> 80/10	<b>KURBELABZIEHER</b> ›TB-CR 10‹ <ul style="list-style-type: none"> <li><b>2 in 1</b> Kurbelwerkzeug</li> <li>für Standard-Vierkantinnenlager oder Shimano Octalink / ISIS Vielzahnachsen</li> <li>weicher und <b>rutschfester 2-Komponentengriff</b></li> <li>auf Super B Eurolochkarte</li> </ul>	<b>CRANK TOOL</b> ›TB-CR 10‹ <ul style="list-style-type: none"> <li><b>2 in 1</b> crank tool</li> <li>for standard square axle bottom brackets or Shimano Octalink / ISIS multi-tooth axles</li> <li>soft <b>non-slip two-component grip</b></li> <li>on Super B eurohole card</li> </ul> <p style="text-align: right;">UVP 19,90 €</p>	
<b>880498</b> 10	<b>AUSRICHTMESSWERKZEUG FÜR SCHALTAUGEN</b> <b>›TB-1946‹</b> <ul style="list-style-type: none"> <li>zum <b>Vermessen und korrekten Ausrichten</b> verbogener Schaltaugen</li> <li>im Super B Einzelkarton</li> </ul>	<b>DERAILLEUR HANGER ALIGNMENT GAUGE</b> <b>›TB-1946‹</b> <ul style="list-style-type: none"> <li>for <b>measuring and precise alignment</b> of derailleur hangers</li> <li>in Super B box</li> </ul> <p style="text-align: right;">UVP 77,90 €</p>	
<b>880500</b> 100 <b>NEW</b>	<b>NOTFALL-AUSFALLENDE</b> <ul style="list-style-type: none"> <li><b>ersetzt</b> vorübergehend ein <b>abgebrochenes Schaltauge</b></li> <li><b>ermöglicht die Heimfahrt</b>, da einige Gänge schaltbar bleiben</li> <li><b>passend für die meisten Rahmen</b> und Ausfallenden</li> <li>für gängige 9 mm Nabenachsen</li> <li>Inklusive Kontermutter passend für 5 mm QR-Achse</li> <li>auf Super B Eurolochkarte</li> </ul>	<b>EMERGENCY HANGER</b> <ul style="list-style-type: none"> <li>temporarily <b>replaces a broken derailleur hanger</b></li> <li><b>allows you to ride home</b> because some gears can still be shifted</li> <li><b>suitable for most frames</b> and dropouts</li> <li>for standard 9 mm hub axles</li> <li>with locknut for 5 mm QR axle</li> <li>on Super B eurohole card</li> </ul> <p style="text-align: right;">UVP 11,90 €</p>	



ART.-NR. 	BESCHREIBUNG	DESCRIPTION	
<b>880450</b> 100	<b>3 IN 1 KETTENWERKZEUG ›TB-3327‹</b> <ul style="list-style-type: none"> <li>• <b>3 in 1:</b> <ul style="list-style-type: none"> <li>- Kettenverschleißmesslehre</li> <li>- Zahnkranzverschleißmesslehre</li> <li>- Kettenhalter für Montage von Ketten</li> </ul> </li> <li>• auf Super B Eurolochkarte</li> </ul>	<b>3 IN 1 CHAIN TOOL ›TB-3327‹</b> <ul style="list-style-type: none"> <li>• <b>3 in 1:</b> <ul style="list-style-type: none"> <li>- chain wear indicator</li> <li>- chainring wear indicator</li> <li>- chain keeper for mounting of chains</li> </ul> </li> <li>• on Super B eurohole card</li> </ul>	<div style="border: 1px solid black; padding: 5px; display: inline-block;">3 IN 1</div> 
			
<b>880427</b> 30	<b>ZAHNKRANZZANGE ›TB-FW50‹</b> <ul style="list-style-type: none"> <li>• <b>leichte und schnelle Befestigung</b> durch <b>Festklemmungsmöglichkeit</b> am Zahnkranz</li> <li>• hält den Zahnkranz in Position zum <b>leichteren Lösen des Zahnkranzes</b></li> <li>• <b>stufenlos einstellbar für 10 bis 23 Zähne</b></li> <li>• für 1- bis 12-fach Freilauf- und Kassettenzahnkränze</li> <li>• passend für 1/2" x 1/8" und 1/2" x 3/32"</li> <li>• auf Super B Eurolochkarte</li> </ul>	<b>SPROCKET TOOL ›TB-FW50‹</b> <ul style="list-style-type: none"> <li>• <b>easy and quick fixation with clamp option</b> at the sprocket</li> <li>• keeps the sprocket in position for <b>easier dismantling of sprocket</b></li> <li>• <b>steplessly adjustable for 10 up to 23 teeth</b></li> <li>• for 1 to 12 speed freewheels and cassette sprockets</li> <li>• suitable for 1/2" x 1/8" and 1/2" x 3/32"</li> <li>• on Super B eurohole card</li> </ul>	
<b>880423</b> 50	<b>ZAHNKRANZPEITSCHER ›TB-FW 20‹</b> <ul style="list-style-type: none"> <li>• für alle 5- bis 11-fach Freilauf- und Kassettenzahnkränze</li> <li>• <b>weicher und rutschfester 2-Komponentengriff</b></li> <li>• auf Super B Eurolochkarte</li> </ul>	<b>SPROCKET WHIP ›TB-FW 20‹</b> <ul style="list-style-type: none"> <li>• for all 5 to 11 speed freewheels and cassette sprockets</li> <li>• <b>soft non-slip two-component grip</b></li> <li>• on Super B eurohole card</li> </ul>	
<b>880082</b> 50/10	<b>KASSETTENZAHNKRANZ-ABZIEHER ›TB-FW 30‹</b> <ul style="list-style-type: none"> <li>• für Shimano HG- und Sram-Kassetten, ...</li> <li>• mit Pin zur besseren Fixierung in der Schnellspannachse</li> <li>• auch passend für einige Shimano <b>Scheibenbremsen-Verschlussringe</b></li> <li>• <b>weicher und rutschfester 2-Komponentengriff</b></li> <li>• auf Super B Eurolochkarte</li> </ul>	<b>SPROCKET REMOVER ›TB-FW 30‹</b> <ul style="list-style-type: none"> <li>• for Shimano HG and Sram sprockets, ...</li> <li>• with pin for better fixation at the QR axle</li> <li>• also usable for some Shimano <b>disc brake counter rings</b></li> <li>• <b>soft non-slip two-component grip</b></li> <li>• on Super B eurohole card</li> </ul>	
<b>880488</b> 6 <b>NEW</b>	<b>STEUERSATZ-WERKZEUG ›TB-1935‹</b> <ul style="list-style-type: none"> <li>• <b>passend für die meisten Lager-schalen</b></li> <li>• für 1", 1 1/8", 1 1/4" und 1 1/2"</li> <li>• im Super B Einzelkarton</li> </ul>	<b>HEAD SET TOOL ›TB-1935‹</b> <ul style="list-style-type: none"> <li>• <b>usable for most conventional headset cups</b></li> <li>• for 1", 1 1/8", 1 1/4" and 1 1/2"</li> <li>• OEM</li> </ul>	



ART.-NR. 	BESCHREIBUNG	DESCRIPTION	
<b>880235</b> 80	<b>STEUERSATZSCHLÜSSEL</b> <b>›TB-HS 36‹</b> <ul style="list-style-type: none"> <li>• <b>extra flache</b> Ausführung</li> <li>• höchste <b>Präzision</b> durch <b>Laserschnitt</b></li> <li>• <b>CrMo</b>-Stahl</li> <li>• 32 und 36 mm (1" und 1½")</li> <li>• auf Super B Eurolochkarte</li> </ul>	<b>HEAD SET WRENCH</b> <b>›TB-HS 36‹</b> <ul style="list-style-type: none"> <li>• <b>extra flat</b> design</li> <li>• highest <b>precision</b> because of <b>laser cut</b></li> <li>• <b>CrMo</b> steel</li> <li>• 32 and 36 mm (1" and 1½")</li> <li>• on Super B eurohole card</li> </ul>	 <p style="text-align: right;">UVP 24,90 €</p>
<b>883135</b> 20	<b>MULTIFUNKTIONS-PEDAL- UND NABENSCHLÜSSEL</b> <b>›TB-MW 50‹</b> <ul style="list-style-type: none"> <li>• 15 mm Maulschlüssel flach</li> <li>• 14/15 mm Außensechskantschlüssel für Achsmuttern</li> <li>• weicher und <b>rutschfester 2-Komponentengriff</b></li> <li>• auf Super B Eurolochkarte</li> </ul>	<b>MULTI FUNCTIONAL PEDAL AND HUB WRENCH</b> <b>›TB-MW 50‹</b> <ul style="list-style-type: none"> <li>• 15 mm flat open wrench</li> <li>• 14/15 mm hex wrench for axle nuts</li> <li>• soft <b>non-slip two-component grip</b></li> <li>• on Super B eurohole card</li> </ul>	 <p style="text-align: right;">UVP 20,90 €</p>
<b>881080</b> 100/25	<b>BREMSSCHEIBEN- RICHTWERKZEUG</b> ›TB-MW40‹ <ul style="list-style-type: none"> <li>• zum <b>präzisen Richten</b> der <b>Bremsscheibe</b></li> <li>• <b>zwei</b> verschiedene <b>Einstecktiefen</b></li> <li>• griffgünstig <b>abgewinkelte</b> Form</li> <li>• weicher und <b>rutschfester 2-Komponentengriff</b></li> <li>• auf Super B Eurolochkarte</li> </ul>	<b>ROTOR TRUING FORK</b> <b>›TB-MW40‹</b> <ul style="list-style-type: none"> <li>• for <b>precise truing</b> of the <b>brake disc</b></li> <li>• <b>two</b> different <b>slot depths</b></li> <li>• easy to grip <b>bent</b> handle</li> <li>• soft <b>non-slip two-component grip</b></li> <li>• on Super B eurohole card</li> </ul>	 <p style="text-align: right;">UVP 18,90 €</p>
<b>880280</b> 20 set	<b>KONUSSCHLÜSSEL-SET</b> <b>›TB-HB 100‹</b> <ul style="list-style-type: none"> <li>• weicher und <b>rutschfester 2-Komponentengriff</b></li> <li>• 13, 14, 15, 16, 17, 18, 19 mm</li> <li>• auf Super B Eurolochkarte</li> </ul>	<b>HUB CONE WRENCH SET</b> <b>›TB-HB 100‹</b> <ul style="list-style-type: none"> <li>• soft <b>non-slip two-component grip</b></li> <li>• 13, 14, 15, 16, 17, 18, 19 mm</li> <li>• on Super B eurohole card</li> </ul>	 <p style="text-align: right;">UVP 96,90 €</p>
<b>881965</b> 50 set	<b>SPEZIAL INNENSECHSKANT- SCHLÜSSELSET</b> ›TB-TH35‹ <ul style="list-style-type: none"> <li>• für <b>defekte, rundgedrehte</b> oder <b>schwer lösbare Innensechskantschrauben</b></li> <li>• 2, 2,5, 3, 4, 5, 6, 8, 10 mm</li> <li>• <b>gehärteter Spezialstahl</b></li> <li>• auf Super B Eurolochkarte</li> </ul>	<b>SPECIAL ALLEN KEY SET</b> <b>›TB-TH35‹</b> <ul style="list-style-type: none"> <li>• für <b>defective, rounded</b> or <b>clamping allen bolts</b></li> <li>• 2, 2.5, 3, 4, 5, 6, 8, 10 mm</li> <li>• <b>hardened special steel</b></li> <li>• on Super B eurohole card</li> </ul>	 <p style="text-align: right;">UVP 34,90 €</p>

ART.-NR. 	BESCHREIBUNG	DESCRIPTION	
	<p><b>DREI-ARM-SCHLÜSSEL</b></p> <ul style="list-style-type: none"> <li>mit weichem, <b>ergonomisch</b> geformtem <b>Anti-Rutsch-Gummibezug</b></li> <li>auf Super B Eurolochkarte</li> </ul>	<p><b>THREE-ARM-WRENCH</b></p> <ul style="list-style-type: none"> <li>with soft, <b>ergonomic non-slip rubber grip</b></li> <li>on Super B eurohole card</li> </ul>	
<b>881969</b>	TB-YY 25 <b>6 Funktionen: Innensechskantschlüssel 4/5/6 mm, Sechskantnüsse 8/10/12 mm</b>	TB-YY 25 <b>6 functions: allen keys 4/5/6 mm, hexagonal nuts 8/10/12 mm</b> UVP 13,90 €	<b>6 IN 1</b> 
<b>880985</b>	TB-YY 10 <b>Vielzahnschlüssel T25/T30/T40</b>	TB-YY 10 <b>star screwdriver keys T25/T30/T40</b> UVP 11,90 €	<b>3 IN 1</b> 
<b>880986</b>	TB-YY 15 <b>Innensechskantschlüssel 4/5/6 mm</b>	TB-YY 15 <b>allen keys 4/5/6 mm</b> UVP 11,90 €	
<b>880987</b> 100/10	TB-YY 20 <b>Außensechskantschlüssel 8/9/10 mm</b>	TB-YY 20 <b>hex keys 8/9/10 mm</b> UVP 11,90 €	
<b>880984</b> 100/25	<p><b>KETTENBLATTSCHRAUBENWERKZEUG ›TB-TH20‹</b></p> <ul style="list-style-type: none"> <li>klein, handlich und multifunktional</li> <li>mit: Vielzahnschlüssel T40, Innensechskant 6 mm und Kettenblattschraubendreher</li> <li>weicher und <b>rutschfester 2-Komponentengriff</b></li> <li>auf Super B Eurolochkarte</li> </ul>	<p><b>CHAINRING SCREW TOOL ›TB-TH 20‹</b></p> <ul style="list-style-type: none"> <li>small, handy and multifunctional</li> <li>with: star screwdriver T40, allen key 6 mm and chainring nut</li> <li>soft <b>non-slip two-component grip</b></li> <li>on Super B eurohole card</li> </ul>	
<b>880001</b> 10	<p><b>HINTERBAUABSPREIZER ZUR REIFEN- UND SCHLAUCHMONTAGE ›TB-RT 05‹</b></p> <ul style="list-style-type: none"> <li><b>Reifen- und Schlauchmontage</b> möglich, <b>ohne</b> das Laufrad <b>ausbauen</b> zu müssen</li> <li>besonders nützlich bei Nabenschaltungen</li> <li>im Super B Einzelkarton</li> </ul>	<p><b>REAR TRIANGLE SPREADER FOR TIRE AND TUBE ASSEMBLY ›TB-RT 05‹</b></p> <ul style="list-style-type: none"> <li><b>tire and tube mounting</b> possible, <b>without removing</b> the wheel</li> <li>particularly useful for gear hubs</li> <li>in Super B box</li> </ul>	
<b>880008</b> 100/25 pair	<p><b>REIFENHEBER ›TB-TL 20‹</b></p> <ul style="list-style-type: none"> <li>äußerst <b>stabiler Stahl</b>reifenheber, für große <b>Hebelkräfte</b> geeignet</li> <li>geschwungenes Ende mit <b>abgeflachten Kanten</b></li> <li>weicher und <b>rutschfester 2-Komponentengriff</b></li> <li>1 Set = 2 Stück</li> <li>auf Super B Eurolochkarte</li> </ul>	<p><b>TIRE LEVER ›TB-TL 20‹</b></p> <ul style="list-style-type: none"> <li>extremely <b>firm steel</b> tire lever for high <b>leverage</b></li> <li>rolling end with <b>flattened brims</b></li> <li>soft <b>non-slip two-component grip</b></li> <li>1 set = 2 pieces</li> <li>on Super B eurohole card</li> </ul>	

ART.-NR. 	BESCHREIBUNG	DESCRIPTION	
<b>880436</b> 60/10	<b>KETTENNIETDRÜCKER</b> ›TB-CC 65‹ <ul style="list-style-type: none"> <li>• für <b>1-12-fach</b> Ketten</li> <li>• <b>hohe Präzision</b> beim Drücken der Bolzen</li> <li>• automatische Fixierung der Kette</li> <li>• <b>CR-V-Stahl mit Holzgriff</b></li> <li>• auf Super B Eurolochkarte</li> </ul>	<b>CHAIN RIVETING TOOL</b> ›TB-CC 65‹ <ul style="list-style-type: none"> <li>• for <b>1-12 speed</b> chains</li> <li>• <b>high precision</b> when pushing the bolts</li> <li>• automatic chain lock</li> <li>• <b>CR-V steel with wooden handle</b></li> <li>• on Super B eurohole card</li> </ul>	
<b>880036</b> 100/25	<b>KETTENNIETDRÜCKER</b> <ul style="list-style-type: none"> <li>• patentiertes Design für höchste Präzision beim Heraus- und Hineindrücken der Bolzen</li> <li>• aus <b>CR-V-Stahl</b></li> <li>• ergonomisch geformter Griff</li> <li>• mit <b>Ersatzstift</b></li> <li>• auf Super B Eurolochkarte</li> </ul>	<b>CHAIN RIVETING TOOL</b> ›TB-CC 60‹ <ul style="list-style-type: none"> <li>• patented design for highest precision when removing or riveting bolts</li> <li>• made of <b>CR-V steel</b></li> <li>• ergonomically shaped grip</li> <li>• with <b>replacement pin</b></li> <li>• on Super B eurohole card</li> </ul>	
<b>880033</b> 100/25	<b>KETTENNIETDRÜCKER</b> ›TB-CC 50‹ <ul style="list-style-type: none"> <li>• für alle 5 - 10-fach Ketten</li> </ul>	<b>CHAIN RIVETING TOOL</b> ›TB-CC 50‹ <ul style="list-style-type: none"> <li>• for all 5 - 10 speed chains</li> </ul>	
<b>880034</b> 100/50 set	<b>ERSATZPIN-SET FÜR KETTENNIETER</b> ›TB-1103‹ <ul style="list-style-type: none"> <li>• passend für alle <b>Super B Kettennieter</b> und viele andere, ...</li> <li>• 10 Stück in Super B Eurolochbox</li> </ul>	<b>REPLACEMENT PIN SET FOR CHAIN RIVETING TOOL</b> ›TB-1103‹ <ul style="list-style-type: none"> <li>• suitable for all <b>Super B chain riveting tools</b> and many others, ...</li> <li>• 10 pcs in Super B eurohole box</li> </ul>	
<b>880310</b> 80/10	<b>KABELZANGE</b> ›TB-WC 30‹ <ul style="list-style-type: none"> <li>• <b>hochwertige Ausführung</b></li> <li>• für verschiedene Durchmesser von Zügen und Hüllen</li> <li>• im Griff integrierter <b>Aufspreizer</b> für Hüllen</li> <li>• auch zum <b>Verpressen</b> der Zughülsen</li> <li>• weicher und <b>rutschfester 2-Komponentengriff</b></li> <li>• auf Super B Eurolochkarte</li> </ul>	<b>CABLE CUTTER</b> ›TB-WC 30‹ <ul style="list-style-type: none"> <li>• <b>high quality</b></li> <li>• for various diameters of cables and cable housings</li> <li>• <b>spreading tool</b> for outer casings integrated in the handle</li> <li>• also for <b>pressing</b> cable ends</li> <li>• soft <b>non-slip two-component grip</b></li> <li>• on Super B eurohole card</li> </ul>	

ART.-NR. 	BESCHREIBUNG	DESCRIPTION	
<b>880056</b> 5 set	<b>FAHRRAD-WERKZEUGKOFFER ›TBA-2000‹</b> <b>36-teilig</b> in hochwertigem Klappkoffer <ul style="list-style-type: none"> <li>• 2 Flach- und 2 Kreuzschraubenzieherbits</li> <li>• 2 Vielzahnschlüsselbits T25 &amp; T30</li> <li>• L-Schlüssel mit 8/9/10 mm Außen-sechskant-Bits und Bithalter</li> <li>• langer L-Schlüssel mit 8 mm Innen-sechskant für Kurbelabzieher</li> <li>• Kurbelabzieher</li> <li>• Zahnkranzabzieher</li> <li>• Gabelschlüssel 8/10 mm</li> <li>• Zahnkranzpeitsche</li> <li>• Steuersatzschlüssel 32/36 mm</li> <li>• Konusschlüssel (13/15 + 14/16 mm)</li> <li>• Nippelspanner 3,2/3,3/3,5/4,0 mm</li> <li>• Innensechskantschlüssel 2/2,5/3/4/5/6 mm</li> <li>• Adapter 1/2" Antrieb</li> <li>• Pedalarm Schlüssel 15/14 mm Außen-sechskant &amp; 15 mm Maulschlüssel flach</li> <li>• Innenlagerwerkzeug Shimano Vielzahn</li> <li>• Innenlagerwerkzeug für Hollowtech II / Truvativ / FSA / Campagnolo außen-liegende Lagerschalen</li> <li>• 8-Zahn Schlüssel für Shimano Octalink II Verschlusskappe</li> <li>• Kettennietdrücker mit Ersatzpin</li> <li>• Kettenblattschraubenschlüssel mit 9/10 mm Ringschlüssel</li> <li>• 3 Reifenheber mit Stahlkern</li> </ul>	<b>BICYCLE TOOL SET ›TBA-2000‹</b> <b>36 parts</b> in high quality folding case <ul style="list-style-type: none"> <li>• 2 flat and 2 Phillips screwdriver bits</li> <li>• 2 star screwdriver bits T25 &amp; T30</li> <li>• L-wrench with 8/9/10 mm hex bits and bit holder</li> <li>• long L-wrench with 8 mm allen key for crankset remover</li> <li>• crankset remover</li> <li>• freewheel remover</li> <li>• open wrench 8/10 mm</li> <li>• chain whip</li> <li>• head set wrench 32/36 mm</li> <li>• flat cone wrench (13/15 + 14/16 mm)</li> <li>• spoke wrench 3.2/3.3/3.5/4.0 mm</li> <li>• allen keys 2/2.5/3/4/5/6 mm</li> <li>• 1/2" drive adapter</li> <li>• pedal arm wrench 15/14 mm hex &amp; 15 mm open wrench</li> <li>• bottom bracket tool for Shimano</li> <li>• bottom bracket tool for Hollowtech II / Truvativ / FSA / Campagnolo outer bearings</li> <li>• 8 teeth wrench for Shimano Octalink II cover lids</li> <li>• chain riveting tool with spare bolt</li> <li>• chainring screw wrench with 9/10 mm hex wrench</li> <li>• 3 tire levers with steel core</li> </ul> <p style="text-align: right;">UVP 209,00 €</p>	 



## CLASSIC WERKZEUGE

**Super B Classic Serie** Werkzeuge bieten dem ambitionierten Biker für die **Heimwerkstatt** die Möglichkeit, sich **kostengünstig** mit **qualitativ hochwertigen** und haltbaren Werkzeugen auszurüsten. Praktische Details und sinnvolle Spezifikationen lassen keine Wünsche offen.

## CLASSIC TOOLS

**Super B Classic Series** tools give every ambitious cyclist the opportunity to purchase **high quality** and **great value** tools for his **home bicycle workshop**. Practical details and useful specifications leave nothing to be desired.



<b>881040</b> 2	<b>KLAPP-MONTAGE-/REPARATURSTÄNDER ›TB-WS20‹</b> <ul style="list-style-type: none"> <li>• superpraktischer <b>Aluminium-</b>Montageständer</li> <li>• nur 5,4 kg</li> <li>• in ca. <b>10 Sekunden zusammenleg- und aufbaubar!</b></li> <li>• <b>Klemme 360° drehbar</b></li> <li>• mit Ablageschale (Werkzeug im Lieferumfang nicht enthalten)</li> <li>• universell auf Rohrdurchmesser einstellbar</li> <li>• <b>höhenverstellbar</b></li> <li>• <b>stabiler</b> Stand</li> <li>• max. Traglast: 40 kg</li> <li>• im Super B Einzelkarton</li> </ul>	<b>FOLDABLE UNIVERSAL WORKSTATION ›TB-WS20‹</b> <ul style="list-style-type: none"> <li>• super practical <b>aluminium</b> workstand</li> <li>• only 5.4 kg</li> <li>• <b>foldable</b> and <b>defoldable</b> in approx. <b>10 seconds!</b></li> <li>• <b>clamp 360° turnable</b></li> <li>• with tool tray (tools not included)</li> <li>• universally adjustable to tube diameter</li> <li>• <b>height adjustable</b></li> <li>• <b>stable</b> stand</li> <li>• max. load: 40 kg</li> <li>• in Super B box</li> </ul> <p style="text-align: right;">UVP 299,00 €</p>	<div style="border: 1px solid black; padding: 5px; width: fit-content;"> <ul style="list-style-type: none"> <li>• E-BIKE ✓</li> <li>• 40 KG ✓</li> </ul> </div>  
<b>881043</b> 30	<b>ERSATZEINSATZ FÜR KLEMME ›TB-WS20A‹</b> <ul style="list-style-type: none"> <li>• für Montageständer Art. 881040, 880062/75, ...</li> <li>• 2 Klemmeinsätze aus Gummi mit Befestigungsmaterial</li> <li>• Montageverpackung</li> </ul>	<b>REPLACEMENT CLAMP INSERT ›TB-WS20A‹</b> <ul style="list-style-type: none"> <li>• for assembly stand art. 881040, 880062/75, ...</li> <li>• 2 clamp inserts made of rubber with mounting material</li> <li>• OEM</li> </ul> <p style="text-align: right;">UVP 9,90 €</p>	



ART.-NR.	BESCHREIBUNG	DESCRIPTION	
<p><b>880312</b> 100/25</p>	<p><b>EINZIEHHILFE FÜR INTERNE KABELFÜHRUNG ›TB-IR20‹</b></p> <ul style="list-style-type: none"> <li>zum <b>einfachen Einziehen von Zügen und Hüllen</b> durch <b>magnetische Führung</b> von außen</li> <li>für <b>Zughüllen, Bremsleitungen, Shimano Di2-Kabel, ...</b></li> <li>1,3 m Führungsseil</li> <li>3 Buchsen für Hüllen und Di2-Kabel</li> <li>1 Magnetadapter</li> <li>auf Super B Eurolochkarte</li> </ul>	<p><b>INTERNAL CABLE ROUTING TOOL ›TB-IR20‹</b></p> <ul style="list-style-type: none"> <li>for <b>easy insertion of cables and housings</b> by <b>magnetic routing</b> from the outside</li> <li>for <b>internal cables, hydraulic hoses, Shimano Di2 cables, ...</b></li> <li>1.3 m guiding line</li> <li>3 sockets for hoses and Di2 cables</li> <li>1 magnetic adapter</li> <li>on Super B eurohole card</li> </ul>  <p>UVP 29,90 €</p>	 
<p><b>881081</b> 100/25</p>	<p><b>BREMSBELAGSPREIZER ›TB-8075‹</b></p> <ul style="list-style-type: none"> <li>zum <b>Auseinanderpressen der Bremsbeläge/Kolben</b></li> <li>erleichtert das Wechseln der Bremsbeläge und das Einsetzen der Laufräder</li> <li>breite Form verhindert Beschädigung der Bremsbeläge</li> <li>weicher, <b>abgewinkelter</b> Griff</li> <li>auf Super B Eurolochkarte</li> </ul>	<p><b>BRAKE PISTON PRESS ›TB-8075‹</b></p> <ul style="list-style-type: none"> <li>designed to <b>compress the pistons</b> and <b>pushing the brake pads apart</b></li> <li>makes changing the pads and fitting the wheels easier</li> <li>broad shape prevents damage of the pads</li> <li>soft, <b>bent</b> grip</li> <li>on Super B eurohole card</li> </ul> <p>UVP 15,90 €</p>	
<p><b>880433</b> 100/25</p>	<p><b>MONTAGEHILFE FÜR BREMSSCHEIBEN ›TB-BR10‹</b></p> <ul style="list-style-type: none"> <li>Werkzeug zum <b>Ausrichten der Bremsbeläge bei Scheibenbremsen</b></li> <li><b>Bremsbelag-Distanzhalter</b> bei ausgebautem Laufrad</li> <li>mit Schlüsselring</li> <li>auf Super B Eurolochkarte</li> </ul>	<p><b>ALIGNMENT TOOL FOR BRAKE DISCS ›TB-BR10‹</b></p> <ul style="list-style-type: none"> <li>tool for <b>adjusting the brake pads of disc brakes</b></li> <li><b>brake pad spacer</b> in case of dismantled wheel</li> <li>with key ring</li> <li>on Super B eurohole card</li> </ul> <p>UVP 5,90 €</p>	<p><b>2 IN 1</b></p> 
<p><b>880430</b> 100/25</p>	<p><b>BREMSSCHUHEINSTELLHILFE ›TB-BR20‹</b></p> <ul style="list-style-type: none"> <li>zum <b>einfachen Feinjustieren der Bremschuhe</b> an die Felge</li> <li>für Felgenbreite 19 - 32 mm</li> <li>max. Felgenhöhe 50 mm</li> <li>breite Form verhindert Beschädigung der Felge</li> <li>auf Super B Eurolochkarte</li> </ul>	<p><b>BRAKE SHOE TUNER ›TB-BR20‹</b></p> <ul style="list-style-type: none"> <li>for <b>easy fine adjustment of brake shoes</b> at the rim</li> <li>for rim width 19 - 32 mm</li> <li>max. rim height 50 mm</li> <li>wide shape prevents damage of the rim</li> <li>on Super B eurohole card</li> </ul> <p>UVP 7,90 €</p>	
<p><b>880483</b> 20/5</p>	<p><b>ROHRSCNEIDER ›TB-1917‹</b></p> <ul style="list-style-type: none"> <li>geeignet für Rohre von 6 - 38 mm (1" - 1½")</li> <li>für Gabelschäfte, Lenker, Sattelstützen, ...</li> <li>mit <b>Entgrater</b></li> <li>inkl. <b>Ersatzklinge</b></li> <li>in Super B Blisterverpackung</li> </ul>	<p><b>TUBE CUTTER ›TB-1917‹</b></p> <ul style="list-style-type: none"> <li>suitable for 6 - 38 mm tubes (1" - 1½")</li> <li>for steerer tubes, handlebars, seat posts, ...</li> <li>with <b>deburring tool</b></li> <li>inkl. <b>replacement knife</b></li> <li>in Super B blister packaging</li> </ul> <p>UVP 76,90 €</p>	

ART.-NR. 	BESCHREIBUNG	DESCRIPTION	
<b>880311</b> 100/25	<b>SCHNEIDWERKZEUG FÜR HYDRAULIKLEITUNGEN ›TB-HC20‹</b> <ul style="list-style-type: none"> <li>• universell passend</li> <li>• sehr <b>sauberer Schnitt</b></li> <li>• stabile Kunststoffausführung</li> <li>• mit <b>Reserveklinge</b></li> <li>• in Super B Blisterverpackung</li> </ul>	<b>HYDRAULIC HOSE CUTTER ›TB-HC20‹</b> <ul style="list-style-type: none"> <li>• universally suitable</li> <li>• very <b>clean cut</b></li> <li>• stable plastic version</li> <li>• with <b>replacement blade</b></li> <li>• in Super B blister packaging</li> </ul>	<p>UVP 13,90 €</p>
<b>880222</b> 20/10	<b>GABELKONUSABZIEHER ›TB-1925‹</b> <ul style="list-style-type: none"> <li>• <b>Werkzeug zum Entfernen des Gabelkonus</b> des Steuersatzes</li> <li>• passend für <b>1" - 1,5"</b></li> <li>• in Super B Blisterverpackung</li> </ul>	<b>HEAD SET CONE REMOVER ›TB-1925‹</b> <ul style="list-style-type: none"> <li>• <b>tool for removing the head set cone</b> from the fork</li> <li>• suitable for <b>1" - 1.5"</b></li> <li>• in Super B blister packaging</li> </ul>	<p>UVP 41,90 €</p>
<b>880081</b> 150	<b>KASSETTENZAHNKRANZ-WERKZEUG ›TB-1015‹</b> <ul style="list-style-type: none"> <li>• für Shimano Hyperglide-Kassette (kein Original Shimano Ersatzteil)</li> <li>• aus <b>CrMo</b></li> <li>• für ½" Steckverbindung oder 19 bzw. 24 mm Schlüssel</li> </ul>	<b>CASSETTE SPROCKET REMOVER ›TB-1015‹</b> <ul style="list-style-type: none"> <li>• for Shimano hyperglide cassette (no original Shimano spare part)</li> <li>• made of <b>CrMo</b></li> <li>• for ½" drive or 19/24 mm wrench</li> </ul>	<p>UVP 6,90 €</p>
<b>880085</b> 100/25	<b>FREILAUFZAHNKRANZ-WERKZEUG ›TB-1045‹</b> <ul style="list-style-type: none"> <li>• passend für <b>Shimano</b> Hyperglide Zahnkränze (kein Original Shimano Ersatzteil)</li> <li>• für 7-fach Ventura-Kassette Art. 700167 und Freilaufzahnkranz Art. 700170/3</li> <li>• auf Super B Eurolochkarte</li> </ul>	<b>FREEWHEEL SPROCKET REMOVER ›TB-1045‹</b> <ul style="list-style-type: none"> <li>• for <b>Shimano</b> hyperglide freewheels (no original Shimano spare part)</li> <li>• for 7-speed Ventura cassette art. 700167 and freewheel art. 700170/3</li> <li>• on Super B eurohole card</li> </ul>	<p>UVP 5,90 €</p>
<b>880084</b> 100/25	<b>›TB-1095‹</b> <ul style="list-style-type: none"> <li>• passend für 24 mm Schlüssel</li> <li>• für (1-fach) Freilaufzahnkränze</li> <li>• auf Super B Eurolochkarte</li> </ul>	<b>›TB-1095‹</b> <ul style="list-style-type: none"> <li>• suitable for 24 mm wrench</li> <li>• for (1-speed) freewheels</li> <li>• on Super B eurohole card</li> </ul>	<p>UVP 10,90 €</p>
<b>880305</b> 100/25	<b>KETTENVERSCHLUSSGLIED-ZANGE ›TB-3323‹</b> <ul style="list-style-type: none"> <li>• <b>2 in 1:</b> zum <b>Öffnen</b> und <b>Verschließen</b> von <b>Kettenverschlussgliedern</b> (z. B. KMC, ...)</li> <li>• komfortabler Kunststoffgriff</li> <li>• auf Super B Eurolochkarte</li> </ul>	<b>CHAIN MASTER LINK PLIER ›TB-3323‹</b> <ul style="list-style-type: none"> <li>• <b>2 in 1:</b> for <b>opening</b> and <b>closing connecting links</b> (e. g. KMC, ...)</li> <li>• comfortable plastic handle</li> <li>• on Super B eurohole card</li> </ul>	<p>UVP 13,90 €</p>

ART.-NR. 	BESCHREIBUNG	DESCRIPTION	
<p><b>880442</b> 100/25</p>	<p><b>KETTENHALTER ›TB-CH10‹</b></p> <ul style="list-style-type: none"> <li>• <b>hält</b> beim Entnehmen des Hinterrades die <b>Kette unter Spannung</b></li> <li>• <b>verhindert</b> das <b>Herabhängen der Kette</b> und somit Beschädigungen am Rahmen</li> <li>• zur Befestigung am Ausfallende</li> <li>• passend für <b>QR und 12 mm Steckachse</b></li> <li>• auf Super B Eurolochkarte</li> </ul>	<p><b>CHAIN KEEPER TOOL ›TB-CH10‹</b></p> <ul style="list-style-type: none"> <li>• <b>keeps the chain under tension</b> when the wheel is removed</li> <li>• <b>prevents chain</b> from <b>hanging down</b> and frame from being damaged</li> <li>• for attachment to the drop out</li> <li>• suitable for <b>QR and 12 mm thru axle</b></li> <li>• on Super B eurohole card</li> </ul> <p style="text-align: right;">UVP 10,90 €</p>	 
<p><b>880106</b> 100</p>	<p><b>REINIGUNGSBÜRSTE ›TB-1711‹</b></p> <ul style="list-style-type: none"> <li>• <b>faltbarer</b> Kunststoffgriff</li> <li>• zum <b>Reinigen</b> der <b>Kassette</b>, Kette und anderer Teile (z. B. Umwerfer, ...)</li> <li>• auf Super B Eurolochkarte</li> </ul>	<p><b>COG BRUSH ›TB-1711‹</b></p> <ul style="list-style-type: none"> <li>• <b>foldable</b> plastic grip</li> <li>• for <b>cleaning the cassette</b>, chain and other parts (e. g. front derailleur, ...)</li> <li>• on Super B eurohole card</li> </ul> <p style="text-align: right;">UVP 7,90 €</p>	  
<p><b>880009</b> 100/25 set</p>	<p><b>REIFENHEBER ›TB-5566‹</b></p> <ul style="list-style-type: none"> <li>• außen Kunststoff</li> <li>• mit stabilem <b>Stahlkern</b></li> <li>• mit 2-fach Haken zum Einhängen in den Speichen</li> <li>• 1 Set = 3 Stück auf Super B Eurolochkarte</li> </ul>	<p><b>TIRE LEVER ›TB-5566‹</b></p> <ul style="list-style-type: none"> <li>• outer surface plastic</li> <li>• with firm <b>steel core</b></li> <li>• with double hook for fixation at the spokes</li> <li>• 1 set = 3 pcs on Super B eurohole card</li> </ul> <p style="text-align: right;">UVP 8,90 €</p>	  
<p><b>880395</b> 160/20 set</p> <p><b>TIP</b></p>	<p><b>REIFENHEBER ›TB-TL18‹</b></p> <ul style="list-style-type: none"> <li>• <b>(De-)Montagehilfe</b></li> <li>• aus hochwertigem Kunststoff</li> <li>• besonders geeignet für Felgenbreiten bis 25 mm</li> <li>• mit <b>Haken</b> zum Einhängen in den Speichen</li> <li>• 1 Set = 2 Reifenheber</li> <li>• 20 Set im Super B <b>Thekendisplay</b></li> </ul>	<p><b>TIRE LEVER ›TB-TL18‹</b></p> <ul style="list-style-type: none"> <li>• <b>(de-)mounting aid</b></li> <li>• made of high quality plastic</li> <li>• especially for rim widths up to 25 mm</li> <li>• with <b>hook</b> for fixation at the spokes</li> <li>• 1 set = 2 tire levers</li> <li>• 20 set in Super B <b>sales display</b></li> </ul> <p style="text-align: right;">UVP 4,90 €</p>	 
<p><b>880007</b> 1050/105</p>	<p><b>REIFENHEBER ›TB-5569‹</b></p> <ul style="list-style-type: none"> <li>• aus hochwertigem Kunststoff</li> <li>• mit <b>2-fach Haken</b> zum Einhängen in den Speichen</li> <li>• grau und orange sortiert</li> <li>• 105 Stück im Super B <b>Thekendisplay</b></li> </ul>	<p><b>TIRE LEVER ›TB-5569‹</b></p> <ul style="list-style-type: none"> <li>• made of high quality plastic</li> <li>• with <b>double hook</b> for fixation at the spokes</li> <li>• grey and orange assorted</li> <li>• 105 pcs in Super B <b>sales display</b></li> </ul> <p style="text-align: right;">UVP 1,09 €</p>	 

ART.-NR. 	BESCHREIBUNG	DESCRIPTION	
<b>880169</b> 120/20 set	<b>REPARATURSET ›TB-1120‹</b> <ul style="list-style-type: none"> <li>• <b>2 Reifenheber</b> (Art. 880007, TB-5569)</li> <li>• <b>Flickset</b> (Art. 880160, TB-1118) mit <b>selbstklebenden</b> Schlauchflicken</li> <li>• <b>praktische Box</b> mit Ringanhänger</li> <li>• 20 Set im <b>Thekendisplay</b></li> </ul>	<b>REPAIR SET ›TB-1120‹</b> <ul style="list-style-type: none"> <li>• <b>2 tire levers</b> (art. 880007, TB-5569)</li> <li>• <b>repair kit</b> (art. 880160, TB-1118) with <b>selfsticking</b> tube patches</li> <li>• <b>handy box</b> with ring tag</li> <li>• 20 set in <b>sales display</b></li> </ul> <p style="text-align: right;">UVP 6,90 € / Set</p>	
<b>880160</b> 900/60 set	<b>REPARATURSET ›TB-1118‹</b> <ul style="list-style-type: none"> <li>• <b>selbstklebende</b> Schlauchflicken</li> <li>• mit Sandpapier</li> <li>• 6 Flicker in Kunststoffdose</li> <li>• 60 Sets im Super B <b>Thekendisplay</b></li> </ul>	<b>REPAIR SET ›TB-1118‹</b> <ul style="list-style-type: none"> <li>• <b>self-sticking</b> tube patches</li> <li>• with sand paper</li> <li>• 6 patches in plastic box</li> <li>• 60 sets in Super B <b>sales display</b></li> </ul> <p style="text-align: right;">UVP 2,50 € / Set</p>	
<b>880428</b> 100/10  <b>880429</b> 100/25	<b>E-MOTOR VERSCHLUSSRING WERKZEUG</b> <ul style="list-style-type: none"> <li>• für <b>Montage und Demontage des Verschlussrings</b> des Spiders/Kettenblatts</li> <li>• CNC-gefräst</li> <li>• auf Super B Eurolochkarte</li> </ul> <b>›TB-1069‹</b> <ul style="list-style-type: none"> <li>• für <b>Bosch Active Line Plus, Bosch Active Line 3. Generation</b> und <b>Brose</b></li> <li>• für ½" Steckverbindung oder 24 mm Schlüssel</li> </ul> <b>›TB-1067‹</b> <ul style="list-style-type: none"> <li>• für <b>Bosch Active Line 2. Generation, Performance Line</b> und <b>Performance Line CX</b></li> <li>• für ½" Steckverbindung</li> </ul>	<b>E-MOTOR LOCKRING TOOL</b> <ul style="list-style-type: none"> <li>• <b>to mount and demount the lockring</b> of the spider/chainring</li> <li>• CNC machined</li> <li>• on Super B eurohole card</li> </ul> <b>›TB-1069‹</b> <ul style="list-style-type: none"> <li>• for <b>Bosch Active Line Plus, Bosch Active Line 3. Generation</b> and <b>Brose</b></li> <li>• for ½" drive or 24 mm wrench</li> </ul> <p style="text-align: right;">UVP 24,90 €</p> <b>›TB-1067‹</b> <ul style="list-style-type: none"> <li>• for <b>Bosch Active Line 2. Generation, Performance Line</b> and <b>Performance Line CX</b></li> <li>• for ½" drive</li> </ul> <p style="text-align: right;">UVP 25,90 €</p>	
<b>881015</b> 10	<b>PRESSFIT INNENLAGERWERKZEUG ›ALL IN 1 TB-19003‹</b> <ul style="list-style-type: none"> <li>• für die einfache und genaue <b>Montage sowie Demontage von Pressfit-Innenlagern</b></li> <li>• für alle gängigen Pressfit-Innenlager (BB 86/90/92 (24 mm), BB30 (30 mm), Sram GXP (22/24 mm), DUB (28,99 mm), ...)</li> <li>• im Super B Einzelkarton</li> </ul>	<b>PRESSFIT BOTTOM BRACKET TOOL ›ALL IN 1 TB-19003‹</b> <ul style="list-style-type: none"> <li>• for easy and accurate <b>installation and removal of pressfit bottom brackets</b></li> <li>• for all current pressfit bottom brackets (BB 86/90/92 (24 mm), BB30 (30 mm), Sram GXP (22/24 mm), DUB (28,99 mm), ...)</li> <li>• in Super B box</li> </ul> <p style="text-align: right;">UVP 71,90 €</p>	<b>ALL IN 1</b> 
<b>881008</b> 80/10	<b>INNENLAGERWERKZEUG ›TB-8912‹</b> <ul style="list-style-type: none"> <li>• für <b>FAG</b> und <b>Campagnolo</b> Innenlager</li> <li>• <b>Non-Slip</b> Griff</li> <li>• auf Super B Eurolochkarte</li> </ul>	<b>BOTTOM BRACKET TOOL ›TB-8912‹</b> <ul style="list-style-type: none"> <li>• for <b>FAG</b> and <b>Campagnolo</b> bottom brackets</li> <li>• <b>non-slip</b> grip</li> <li>• on Super B eurohole card</li> </ul> <p style="text-align: right;">UVP 22,90 €</p>	
<b>880076</b> 100/25	<b>INNENLAGER- UND FREILAUFWERKZEUG ›TB-8018‹</b> <ul style="list-style-type: none"> <li>• <b>universell</b> für <b>Innenlager, Freiläufe</b>, ... verwendbar</li> <li>• mit <b>je zwei austauschbaren Pins</b> 2,2 x 2 mm (Art. 889900) und 2,8 x 2 mm (Art. 889901)</li> <li>• auf Super B Eurolochkarte</li> </ul>	<b>BOTTOM BRACKET AND FREEWHEEL TOOL ›TB-8018‹</b> <ul style="list-style-type: none"> <li>• <b>universally</b> usable for <b>bottom bracket, freewheels</b>, ...</li> <li>• with <b>2 x 2 replaceable pins</b> 2.2 x 2 mm (art. 889900) and 2.8 x 2 mm (art. 889901)</li> <li>• on Super B eurohole card</li> </ul> <p style="text-align: right;">UVP 9,90 €</p>	



ART.-NR.	BESCHREIBUNG	DESCRIPTION	
880078 150/25	<b>INNENLAGERWERKZEUG</b> ›TB-1065‹ <ul style="list-style-type: none"> <li>für Shimano Innenlager (kein Original Shimano Ersatzteil)</li> <li>für 1/2" Steckverbindung oder 24 mm Schlüssel</li> <li>auf Super B Eurolochkarte</li> </ul>	<b>BOTTOM BRACKET TOOL</b> ›TB-1065‹ <ul style="list-style-type: none"> <li>for Shimano bottom bracket (no original Shimano spare part)</li> <li>for 1/2" drive or 24 mm wrench</li> <li>on Super B eurohole card</li> </ul>	
880074 6 set	<b>ZENTRIERSTÄNDER</b> ›TB-PF25‹ <ul style="list-style-type: none"> <li>für 16" - 29" Laufräder</li> <li>automatische Mittigstellung beim Einspannen des Laufrades</li> <li>simultane Kontrolle des Höhen- und Seitenschlages möglich</li> <li>umstellbar von 100 mm auf 130/135 mm</li> <li>Aluminium/Stahl</li> <li>zusammenklappbar</li> <li>im Super B Einzelkarton</li> </ul>	<b>WHEEL TRUING STAND</b> ›TB-PF25‹ <ul style="list-style-type: none"> <li>for 16" - 29" wheels</li> <li>clamps the wheel <b>centric automatically</b></li> <li>simultaneous control of the height and <b>side tolerances</b> possible</li> <li>can be switched from 100 mm to 130/135 mm</li> <li>aluminium/steel</li> <li><b>foldable</b></li> <li>in Super B box</li> </ul>	
880322 40	<b>SPEICHENSPANNUNGSMESSGERÄT</b> ›TB-ST 12‹ <ul style="list-style-type: none"> <li>misst die Speichenspannung fast aller Speichentypen</li> <li>im Super B Einzelkarton</li> </ul>	<b>SPOKE TENSION METER</b> ›TB-ST 12‹ <ul style="list-style-type: none"> <li>measures the spoke tension of almost all types of spokes</li> <li>in Super B box</li> </ul>	
880334 100/25	<b>SPEICHENSCHLÜSSEL</b> ›TB-5501‹ <ul style="list-style-type: none"> <li>zum <b>Gegenhalten</b> von <b>Aerospeichen</b></li> <li>für 0,9/1,1/1,3/1,9 mm</li> <li>auf Super B Eurolochkarte</li> </ul>	<b>SPOKE WRENCH</b> ›TB-5501‹ <ul style="list-style-type: none"> <li>for <b>fixing aero spokes</b> when turning the nipples</li> <li>for 0.9/1.1/1.3/1.9 mm</li> <li>on Super B eurohole card</li> </ul>	
880354 100/50	<b>SPEICHENSCHLÜSSEL</b> ›TB-SW05‹ <ul style="list-style-type: none"> <li>für 0,13"/3,3 mm Nippel (14G)</li> <li>kunststoffummantelter Griff</li> <li>auf Super B Eurolochkarte</li> </ul>	<b>SPOKE WRENCH</b> ›TB-SW05‹ <ul style="list-style-type: none"> <li>for 0.13"/3.3 mm nipples (14G)</li> <li>plastic coated grip</li> <li>on Super B eurohole card</li> </ul>	
880330 10	<b>LAUFRADLEHRE</b> ›TB-1930‹ <ul style="list-style-type: none"> <li>zum <b>schnellen Überprüfen</b> der Mittigkeit eines Laufrads</li> <li>verstellbarer Anschlag mit stufenloser Feinjustierung für die Nabenachse</li> <li>passend für 16" - 29"</li> <li>im Super B Einzelkarton</li> </ul>	<b>WHEELSET TRUING TOOL</b> ›TB-1930‹ <ul style="list-style-type: none"> <li>for <b>quick checking</b> if the wheel is centralised correctly</li> <li>adjustable limit stop with stageless fine tuning for the hub axle</li> <li>suitable for 16" - 29"</li> <li>in Super B box</li> </ul>	
883128 100	<b>PEDAL-DUMMY</b> ›TB-PD 35‹ <ul style="list-style-type: none"> <li>passend für 1/2" und 9/16"</li> <li>auf Super B Eurolochkarte</li> </ul>	<b>DUMMY PEDAL</b> ›TB-PD 35‹ <ul style="list-style-type: none"> <li>suitable for 1/2" und 9/16"</li> <li>on Super B eurohole card</li> </ul>	

ART.-NR. 	BESCHREIBUNG	DESCRIPTION	
<b>883138</b> 50/10	<b>PEDALSCHLÜSSEL</b> ›TB-8625‹ <ul style="list-style-type: none"><li>• Doppelmauschlüssel 2 x 15 mm</li><li>• aus spezialgehärtetem <b>Carbon</b>-Stahl</li><li>• 340 mm</li><li>• auf Super B Eurolochkarte</li></ul>	<b>PEDAL WRENCH</b> ›TB-8625‹ <ul style="list-style-type: none"><li>• double wrench 2 x 15 mm</li><li>• special hardened <b>carbon</b> steel</li><li>• 340 mm</li><li>• on Super B eurohole card</li></ul>	 UVP 18,90 €
<b>880243</b> <b>880244</b> <b>880245</b> <b>880246</b> <b>880247</b> 100/25	<b>KONUSSCHLÜSSELSATZ</b> ›TB-8648-52‹ <ul style="list-style-type: none"><li>• <b>Non-Slip Griff</b></li><li>• extra <b>flache</b> Ausführung</li><li>• für das Einstellen von Naben, ...</li><li>• auf Super B Eurolochkarte</li></ul> 13 mm 14 mm 15 mm 16 mm 17 mm	<b>CONE WRENCH SET</b> ›TB-8648-52‹ <ul style="list-style-type: none"><li>• <b>non-slip handle</b></li><li>• very <b>flat</b> version</li><li>• for adjusting hubs, ...</li><li>• on Super B eurohole card</li></ul> 13 mm 14 mm 15 mm 16 mm 17 mm	 UVP 5,90 €
<b>881911</b> 40/10	<b>DREHMOMENTSCHLÜSSEL</b> ›TB-TW50‹ <ul style="list-style-type: none"><li>• <b>umschaltbar</b> auf 4, 5 oder 6 Nm</li><li>• T-Griff</li><li>• Bits mit 3/4/5 mm Innensechskant und T 25 Vielzahn Schlüssel</li><li>• Bits praktisch im T-Griff verstaubar</li><li>• in Super B Blisterverpackung</li></ul>	<b>TORQUE WRENCH</b> ›TB-TW50‹ <ul style="list-style-type: none"><li>• <b>switchable</b> to 4, 5 or 6 Nm</li><li>• T-handle</li><li>• hex bits with 3/4/5 mm allen key and T 25 star screwdriver</li><li>• bits practically stowable in the T-handle</li><li>• in Super B blister packaging</li></ul>	 UVP 45,90 €
<b>881970</b> <b>881971</b> <b>881972</b> 100/25 <b>881973</b> <b>881974</b> <b>881975</b> 100/25 <b>881976</b> <b>881977</b> 50/10	<b>T-GRIFF INNENSECHSKANT-SCHLÜSSEL</b> ›TB-7631 - 7638‹ <ul style="list-style-type: none"><li>• <b>2-Komponenten-Griff</b></li><li>• aus <b>S2</b>-Stahl</li><li>• auf Super B Eurolochkarte</li></ul> <b>kurzes und langes Ende</b> 2 mm 2,5 mm 3 mm  langes Ende mit <b>Kugelkopf</b> 4 mm 5 mm 6 mm 8 mm 10 mm	<b>T-HANDLE ALLEN KEY SET</b> ›TB-7631 - 7638‹ <ul style="list-style-type: none"><li>• <b>2-component grip</b></li><li>• made of <b>S2</b> steel</li><li>• on Super B eurohole card</li></ul> <b>short and long end</b> 2 mm 2.5 mm 3 mm  long end with <b>ball head</b> 4 mm 5 mm 6 mm 8 mm 10 mm	 UVP 6,90 € UVP 6,90 € UVP 7,90 € UVP 8,90 € UVP 9,90 € UVP 10,90 € UVP 12,90 € UVP 15,90 €
<b>881979</b> 20	<b>HALTER/DISPLAY</b> ›TB-76160-1‹ <ul style="list-style-type: none"><li>• für 8-fach Innensechskant-Schlüsselsatz Art. 881970-7 (ohne Schlüsselsatz)</li><li>• als <b>Stand- oder Wanddisplay</b> zu verwenden</li><li>• bei Verwendung als Wanddisplay mit Handtuch-/Putzlappenhalter</li></ul>	<b>HOLDER/DISPLAY</b> ›TB-76160-1‹ <ul style="list-style-type: none"><li>• for eightfold allen key set art. 881970-7 (w/o allen key set)</li><li>• usable as <b>stand alone or wall display</b></li><li>• with towel/cleaning cloth holder when used as wall display</li></ul>	 UVP 28,90 €

ART.-NR.	BESCHREIBUNG	DESCRIPTION	
<p><b>880055</b></p> <p>20</p>	<p><b>FAHRRADWERKZEUGKOFFER</b></p> <p><b>Basis</b> Werkzeugkoffer mit den wichtigsten <b>Fahrrad Spezialwerkzeugen 8-teilig:</b></p> <ul style="list-style-type: none"> <li>• Freilaufabzieher</li> <li>• Kettenpeitsche</li> <li>• Kurbelabzieher (für Shimano Vierkant und Octalink/ISIS)</li> <li>• geschmiedeter Speichenschlüssel mit 8 Größen 10G-15G</li> <li>• Innenlagerwerkzeug</li> <li>• Kettennietdrücker</li> <li>• 3 Reifenheber</li> <li>• Reparaturkit: 1 Flicker L 2 Flicker M 6 Flicker S 1 Kleber 1 Anleitung</li> </ul>	<p><b>BIKE TOOL KIT</b></p> <p><b>Basis</b> tool kit with the most important <b>special bike tools 8 pcs:</b></p> <ul style="list-style-type: none"> <li>• freewheel remover</li> <li>• chain whip</li> <li>• cotterless crank tool (for Shimano splined and Octalink/ISIS)</li> <li>• spoke wrench forged 8 grooves 10G-15G</li> <li>• cartridge bottom cracket tool</li> <li>• chain riveting tool</li> <li>• 3 tire lever</li> <li>• repair kit: 1 patches L 2 patches M 6 patches S 1 glue 1 instruction</li> </ul> <p>UVP 59,90 €</p>	<p><b>ALL YOU NEED!</b></p>  
<p><b>880040</b></p> <p>60/10</p>	<p><b>WERKZEUGSET ›TB-1170‹</b></p> <p><b>24 in 1 Kompakt-Werkzeugkoffer</b></p> <ul style="list-style-type: none"> <li>• sehr leicht: <b>nur 197 g!</b></li> <li>• für <b>Sattel-, Trikottasche</b> geeignet, da nur 120 x 60 x 25 mm</li> <li>• alle Werkzeuge aus <b>CR-V</b> oder <b>Carbon-Stahl</b></li> <li>• 3/4/5/6 mm Innensechskant</li> <li>• T25 Vielzahnschlüssel</li> <li>• 1 Kreuzschraubenzieher</li> <li>• 1 Schlitzschraubenzieher</li> <li>• <b>1 Kettennietdrücker</b></li> <li>• 8/9/10 mm Ringschlüssel</li> <li>• Multifunktionschlüssel mit Dosenöffner und Schlüssel für Mavic Nippel</li> <li>• Speichenschlüssel 0,127", 0,136", 0,130", 0,136"</li> <li>• 2 Reifenheber</li> <li>• 3 selbstklebende Reifenflicken</li> <li>• Pinhalter</li> <li>• Aufrauer</li> <li>• in Super B Blisterverpackung</li> </ul>	<p><b>TOOL SET ›TB-1170‹</b></p> <p><b>24 in 1 compact tool case</b></p> <ul style="list-style-type: none"> <li>• very light: <b>only 197 g!</b></li> <li>• suitable for <b>saddle or jersey pocket</b> due to small size 120 x 60 x 25 mm</li> <li>• all tools made of <b>CR-V</b> or <b>Carbon</b> steel</li> <li>• 3/4/5/6 mm allen keys</li> <li>• T25 star screwdriver</li> <li>• 1 Phillips screw driver</li> <li>• 1 flat screw driver</li> <li>• <b>1 riveting tool</b></li> <li>• 8/9/10 mm ring wrench</li> <li>• multifunction key with tin opener and key for Mavic nipples</li> <li>• spoke wrenches 0.127", 0.136", 0.130", 0.136"</li> <li>• 2 tire levers</li> <li>• 3 self-sticking tire patches</li> <li>• bolt retainer</li> <li>• metal crasp</li> <li>• in Super B blister packaging</li> </ul> <p>UVP 24,90 €</p>	   
<p><b>880918</b></p> <p>100/25 set</p>	<p><b>MINIWERKZEUG ›TB-FD 40‹</b></p> <p><b>17 in 1 faltwerkzeug</b></p> <ul style="list-style-type: none"> <li>• 2/2,5/3/4/5/6/8 mm Innensechskantschlüssel</li> <li>• T25 Vielzahnschlüssel</li> <li>• 1 Kreuzschraubenzieher</li> <li>• 1 Schlitzschraubenzieher</li> <li>• <b>1 Kettennietdrücker</b></li> <li>• Speichenschlüssel 3,2/3,3/3,5 mm</li> <li>• 2 Reifenheber</li> <li>• mit Neoprenband</li> <li>• nur 73 x 45 x 24 mm</li> <li>• auf Super B Eurolochkarte</li> </ul>	<p><b>MINI TOOL ›TB-FD 40‹</b></p> <p><b>17 in 1 folding tool</b></p> <ul style="list-style-type: none"> <li>• 2/2.5/3/4/5/6/8 mm allen keys</li> <li>• T25 star screwdriver</li> <li>• 1 Phillips screw driver</li> <li>• 1 flat screw driver</li> <li>• <b>1 chain riveting tool</b></li> <li>• spoke wrenches 3.2/3.3/3.5 mm</li> <li>• 2 tire levers</li> <li>• with neopren strap</li> <li>• only 73 x 45 x 24 mm</li> <li>• on Super B eurohole card</li> </ul> <p>UVP 29,90 €</p>	<p><b>bike sport</b> NEWS</p> <p>*****</p>  
<p><b>880990</b></p> <p>160/20 set</p>	<p><b>MINI-MULTIFUNKTIONS- WERKZEUG ›TB-FD08-BK‹</b></p> <ul style="list-style-type: none"> <li>• praktischer <b>Schlüsselanhänger</b></li> <li>• mit <b>8 Funktionen:</b> <ul style="list-style-type: none"> <li>- 3/4/5/6 mm Innensechskantschlüssel</li> <li>- Schlitzschraubendreher</li> <li>- 3,2/3,5 mm Speichenschlüssel</li> <li>- 10 mm Sechskantschlüssel</li> </ul> </li> <li>• auf Super B Eurolochkarte</li> <li>• im 20er Thekendisplay</li> </ul>	<p><b>MINI MULTIFUNCTION TOOL ›TB-FD08-BK‹</b></p> <ul style="list-style-type: none"> <li>• practical <b>key tag</b></li> <li>• with <b>8 functions:</b> <ul style="list-style-type: none"> <li>- 3/4/5/6 mm allen keys</li> <li>- flat screw driver</li> <li>- 3.2/3.5 mm spoke wrench</li> <li>- 10 mm hexagon key</li> </ul> </li> <li>• on Super B eurohole card</li> <li>• 20 pcs in sales display</li> </ul> <p>UVP 6,90 €</p>	<p><b>8 IN 1</b></p>  



ART.-NR. 	BESCHREIBUNG	DESCRIPTION	
<b>880170</b> 100/25	<b>VENTILSCHLÜSSEL ›TB-VC10‹</b> <ul style="list-style-type: none"> <li>• <b>Aluminium</b></li> <li>• zum <b>Einsetzen und Entfernen</b> von <b>Schraderventileinsätzen, französischen Ventilen</b> und <b>Ventilverlängerungen</b></li> <li>• auf Super B Eurolochkarte</li> </ul>	<b>VALVE CORE TOOL ›TB-VC10‹</b> <ul style="list-style-type: none"> <li>• <b>aluminium</b></li> <li>• to <b>install and remove Schrader valve inserts, Presta valves</b> and <b>valve extenders</b></li> <li>• on Super B eurohole card</li> </ul>	<p>UVP 8,90 €</p>
<b>880591</b> 20	<b>ZUGWAAGE ›TB-DS 10‹</b> <ul style="list-style-type: none"> <li>• zum <b>genauen Wiegen</b> von Fahrrädern, Rahmen und Zubehör</li> <li>• Höchstgewicht 50 kg</li> <li>• auf <b>5 g genaue Messung</b> bis 10 kg und auf 10 g genaue Messung bis 50 kg</li> <li>• im Super B Einzelkarton</li> </ul>	<b>HANGING SCALE ›TB-DS 10‹</b> <ul style="list-style-type: none"> <li>• for <b>accurate weighing</b> of bicycles, frames and accessories</li> <li>• max. weight 50 kg</li> <li>• <b>5 g tolerance</b> up to 10 kg and 10 g tolerance up to 50 kg</li> <li>• in Super B box</li> </ul>	<p>UVP 53,90 €</p>
<b>880190</b> 1.000/100	<b>CARBON MONTAGEPASTE ›TB-3256‹</b> <ul style="list-style-type: none"> <li>• für Carboneile</li> <li>• verhindert Verrutschen</li> <li>• <b>niedrigere Klemmkräfte</b> (Drehmoment) reichen für gute Verbindung</li> <li>• <b>leichteres Lösen</b> der Verbindung möglich</li> <li>• in 5 ml Beutel</li> <li>• 100 Beutel im Super B <b>Thekendisplay</b></li> </ul>	<b>ANTI SLIP COMPOUND ›TB-3256‹</b> <ul style="list-style-type: none"> <li>• for carbon parts</li> <li>• prevents slipping</li> <li>• <b>low clamping force</b> (torque) is enough for good connection</li> <li>• connection <b>easily resolvable</b></li> <li>• in 5 ml bag</li> <li>• 100 bags in Super B <b>counter display</b></li> </ul>	<p>UVP 2,50 €</p>
<b>880067</b> 40	<b>MAGNETISCHE SCHALE ›TB-1912‹</b> <ul style="list-style-type: none"> <li>• aus <b>Nirosta</b></li> <li>• zum Sammeln von Schrauben, Muttern, Nippel, ...</li> <li>• Durchmesser ca. 15 cm</li> <li>• in Super B Box</li> </ul>	<b>MAGNETIC BOWL ›TB-1912‹</b> <ul style="list-style-type: none"> <li>• made of <b>stainless steel</b></li> <li>• for keeping screws, nuts, nipples, ...</li> <li>• diameter approx. 15 cm</li> <li>• in Super B box</li> </ul>	<p>UVP 15,90 €</p>

# N

# NOVATEC®

QUALITY • PERFORMANCE • RELIABILITY

[www.novatec-wheels.de](http://www.novatec-wheels.de)











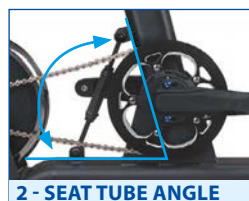















# TOOLS



ART.-NR. 	BESCHREIBUNG	DESCRIPTION
<b>881099</b>	<p><b>BIKE FITTING SYSTEM</b></p> <p>1 Dieses Fahrrad-Einstellsystem ermöglicht es dem Fahrradkäufer und Fahrer, verschiedene Rahmengrößen, Vorbauten und Rahmenwinkel vor dem Kauf zu testen. Die richtige Fahrposition sorgt sowohl für <b>längere Leistungsfähigkeit</b> als auch für <b>Komfort</b>.</p> <p>Die in sich geschlossene, voll einstellbare Einheit ist eine großartige Hilfe in jedem Fahrradladen. Sie <b>hilft</b> nicht nur <b>beim Verkauf</b> und <b>Service</b>, sondern hält auch <b>Lagerhaltungskosten gering</b>. Die Räder können nach dem Ausmessen kundenspezifisch bestellt oder gebaut werden.</p> <p><b>Einstellwerte:</b></p> <ol style="list-style-type: none"> <li>1) Widerstand</li> <li>2) Sitzrohrwinkel</li> <li>3) Tretkurbellänge (160-180 mm)</li> <li>4) Radstand</li> <li>5) Oberrohr</li> <li>6) Steuerrohrwinkel</li> <li>7) Lenker (MTB + Rennrad)</li> <li>8) Vorbau</li> <li>9) Sitzrohr- und Sattelstützlänge</li> <li>10) Steuerrohr</li> </ol>	<p><b>BIKE FITTING SYSTEM</b></p> <p>This bicycle fitting machine makes it possible for a cyclist to try and test a variety of frame sizes, stems and frame angles before purchasing a bike, thus insuring <b>performance</b>, and <b>comfort</b> in the <b>longterm</b>.</p> <p>The self-contained, fully-adjustable unit is a tremendous aid to every bike shop. Not only does the bicycle fitting machine help a bike shop owner <b>provide a better product</b> and <b>service</b>, it potentially means <b>less money tied up in stock</b> as a bike can be ordered or built after a measurement workout with the fitting machine.</p> <p><b>Adjustable measures:</b></p> <ol style="list-style-type: none"> <li>1) Resistance</li> <li>2) Seat tube angle</li> <li>3) Crank length (160-180 mm)</li> <li>4) Wheel distance</li> <li>5) Top Tube</li> <li>6) Head tube angle</li> <li>7) Handlebar (MTB + Road)</li> <li>8) Handle stem</li> <li>9) Seat tube and seat post length</li> <li>10) Head tube</li> </ol> <p style="text-align: right;">UVP 2.899,00 €</p>







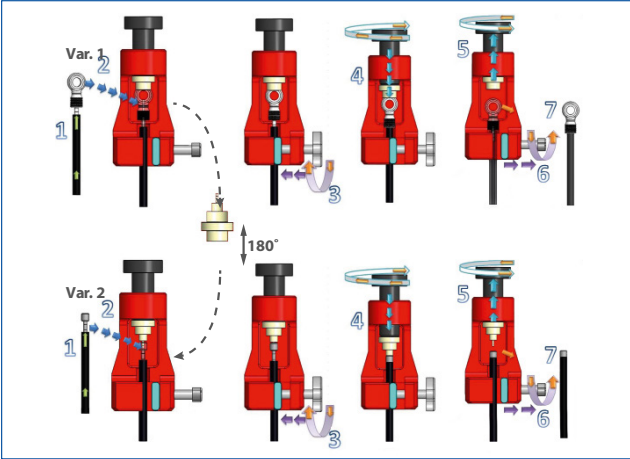

ART.-NR.	BESCHREIBUNG	DESCRIPTION	
<b>880086</b> 100	<b>LAGERFETT</b> <ul style="list-style-type: none"> <li>• sehr <b>hochwertiges</b> Lagerfett</li> <li>• mit <b>PTFE</b> für <b>geringe Reibung</b></li> <li>• <b>temperaturstabil</b></li> <li>• schützt <b>gegen Rost</b></li> <li>• in 150 ml Tube</li> </ul>	<b>GREASE</b> <ul style="list-style-type: none"> <li>• very <b>high quality</b> grease for bearings</li> <li>• with <b>PTFE</b> for <b>low friction</b></li> <li>• <b>temperature stable</b></li> <li>• protects <b>against rust</b></li> <li>• in 150 ml tube</li> </ul>	
<b>880595</b> 100	<b>FETTSPRITZE ›GREASE GUN‹</b> <ul style="list-style-type: none"> <li>• ergonomische Form</li> <li>• <b>Aluminiumkörper</b></li> <li>• durchsichtiges Rohr zur <b>Funktionskontrolle</b></li> <li>• mit einer Hand zu bedienen</li> <li>• passend für Art. 880086, ...</li> <li>• auf M-Wave Eurolochkarte</li> </ul>	<b>GREASE GUN ›GREASE GUN‹</b> <ul style="list-style-type: none"> <li>• ergonomic shape</li> <li>• <b>aluminium</b> body</li> <li>• clear tube for <b>function control</b></li> <li>• easy one-hand operation</li> <li>• suitable for art. 880086, ...</li> <li>• on M-Wave eurohole card</li> </ul>	 
<b>880480</b> 10	<b>STEUERSATZWERKZEUGE</b> <ul style="list-style-type: none"> <li>• <b>Montagewerkzeug</b></li> <li>• für perfekten Sitz der Lagerschalen im Rahmen</li> <li>• aus gehärtetem Spezialstahl</li> <li>• verwendbar von <b>1" bis 1¼"</b></li> <li>• auch passend für 1" bis 1½"</li> <li>• im Polybeutel</li> </ul>	<b>HEAD SET TOOLS</b> <ul style="list-style-type: none"> <li>• <b>assembly tool</b></li> <li>• for perfect fit of the ahead set cups in the frame</li> <li>• special hardened steel</li> <li>• useable from <b>1" to 1¼"</b></li> <li>• also suitable for 1" to 1½"</li> <li>• in PE bag</li> </ul>	
<b>880223</b> 20	<ul style="list-style-type: none"> <li>• <b>Werkzeug zum Einschlagen</b> des Gabelkonus</li> <li>• passend für <b>1" und 1½"</b></li> <li>• im Polybeutel</li> </ul>	<ul style="list-style-type: none"> <li>• <b>head set cone mounting tool</b></li> <li>• suitable for <b>1" and 1½"</b></li> <li>• in PE bag</li> </ul>	
<b>880481</b> 50	<ul style="list-style-type: none"> <li>• Steuersatz-Lagerschalen-Austreiber aus Rahmen</li> <li>• passend für <b>1" und 1½"</b></li> <li>• im Polybeutel</li> </ul>	<ul style="list-style-type: none"> <li>• head set cup remover from the frame</li> <li>• suitable for <b>1" and 1½"</b></li> <li>• in PE bag</li> </ul>	
<b>881023</b> 100	<b>AHEAD-KRALLEN-EINSCHLAGHILFE</b> <ul style="list-style-type: none"> <li>• <b>einfaches</b> und <b>gerades</b> Einschlagen der Kralle bei Aheadsystemen in 1/8" Gabelschäfte</li> <li>• im Polybeutel mit M-Wave-Eurolochheader</li> </ul>	<b>AHEAD CLAW MOUNTING TOOL</b> <ul style="list-style-type: none"> <li>• <b>easy</b> and <b>accurate</b> mounting of the Ahead claw in 1/8" fork steerers</li> <li>• in PE bag with M-Wave eurohole header</li> </ul>	 
<b>880482</b> 30	<b>ROHRABSCHNEIDEHILFE</b> <ul style="list-style-type: none"> <li>• <b>Rohrklemme</b> mit <b>Sägeführung</b></li> <li>• zum Einspannen in einen Schraubstock</li> <li>• Gabelschäfte, Sattelstützen, Lenker, ... können <b>präzise</b> mit einer Eisensäge gekürzt werden</li> <li>• für Rohrdurchmesser 21 - 34 mm</li> <li>• im Polybeutel</li> </ul>	<b>TUBE CUTTING TRACK</b> <ul style="list-style-type: none"> <li>• <b>tube clamp</b> with <b>saw guide</b></li> <li>• for fixing in a bench vice</li> <li>• steerers, seat posts, handlebars, ... can be shortened <b>precisely</b> with a hacksaw</li> <li>• for tube diameters from 21 - 34 mm</li> <li>• in PE bag</li> </ul>	 

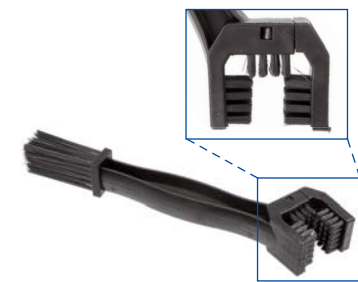
ART.-NR. 	BESCHREIBUNG	DESCRIPTION	
<b>881013</b> 20	<b>INNENLAGER WERKZEUG</b> • für die einfache und <b>genaue Montage von Pressfit Innenlagern</b> (BB30, BB86, BB92) • <b>universell passend</b> für Lagerinnendurchmesser 30 mm, 24 mm (Shimano) und 24/22 mm (Sram/Truvativ GXP) über zusätzlichen Adapterring • mit M-Wave Banderole	<b>BOTTOM BRACKET TOOL</b> • for easy and <b>accurate mounting of pressfit bottom brackets</b> (BB30, BB86, BB92) • <b>universally suitable</b> for inner bearing diameter 30 mm, 24 mm (Shimano) and 24/22 mm (Sram/Truvativ GXP) by additional adapter ring • with M-Wave banderole  UVP 37,90 €	<div data-bbox="1193 232 1273 259">3 IN 1</div>  <div data-bbox="1460 232 1560 286">   M-WAVE                     </div>
<b>881009</b> 50	<b>›BB Screw 1‹</b> • für <b>außenliegende Kugellagerschalen</b> • passend für 12-kerbige außenliegende Lagerschalen (z.B. <b>Sram Dub</b> BSA / Rotor BSA30 / RaceFace Cinch / Zipp Vuma, Hawk Racing BB3086, ...) • im Polybeutel mit Barcode-Aufkleber	<b>›BB Screw 1‹</b> • for <b>outer bearing cups</b> • suitable for 12 notches external BB (e.g. <b>Sram Dub</b> BSA / Rotor BSA30 / RaceFace Cinch / Zipp Vuma, Hawk Racing BB3086, ...) • in PE bag with barcode sticker  UVP 13,90 €	
<b>881003</b> 50	• für außenliegende Kugellagerschalen • passend für Shimano, Truvativ, Race Face, Campagnolo • für 1/2" Steckverbindung	• for outer bearing shells • suitable for Shimano, Truvativ, Race Face, Campagnolo • for 1/2" connector  UVP 14,90 €	
<b>881001</b> 100	• für Shimano Innenlager (kein Original Shimano Ersatzteil) • für 1/2" Steckverbindung und 24 mm Schlüssel • auf M-Wave Eurolochkarte	• for Shimano bottom bracket (no original Shimano spare part) • for 1/2" connector and 24 mm wrench • on M-Wave eurohole card  UVP 6,90 €	 <div data-bbox="1197 1086 1244 1220">                     24 mm                      1/2"                 </div> <div data-bbox="1492 1153 1556 1220">  </div>
<b>880456</b> 50	<b>E-MOTOR VERSCHLUSSRING WERKZEUG ›BB SCREW 2‹</b> • für <b>Montage und Demontage des Verschlussrings</b> des Spiders/Kettenblatts • aus stabilem, wärmebehandeltem Stahl • 2 in 1: 1. Bosch Classic Line (1. Generation) 2. Active Line (2. Generation), Performance Line, Performance Line CX • mit M-Wave Karte	<b>E-MOTOR LOCKRING TOOL ›BB SCREW 2‹</b> • <b>to mount and demount the lockring</b> of the spider/chaining • made of stable, heat-treated steel • 2 in 1: 1. Bosch Classic Line (1. Generation) 2. Active Line (2. Generation), Performance Line, Performance Line CX • with M-Wave tag  UVP 22,90 €	<div data-bbox="1189 1265 1268 1310">2 in 1</div>  <div data-bbox="1460 1265 1560 1319">   M-WAVE                     </div>
<b>880554</b>           <b>880551</b> 200	<b>KURBELABZIEHER</b> für <b>Shimano Octalink</b> und <b>ISIS</b>  für <b>Vierkant-Achsen</b> (max. Drehmoment 50 Nm)	<b>CRANKSET REMOVER</b> for <b>Shimano Octalink</b> and <b>ISIS</b>  for <b>square axles</b> (max. turning moment 50 Nm)  UVP 5,90 €	
<b>880555</b>           <b>880547</b> 100	<b>3 in 1, für Shimano Octalink, ISIS und Vierkant-Achsen</b> auf M-Wave Eurolochkarte  im Polybeutel	<b>3 in 1, for Shimano Octalink, ISIS and square axles</b> on M-Wave eurohole card  in PE bag  UVP 6,90 €	<div data-bbox="1189 1937 1268 1982">3 IN 1</div>  <div data-bbox="1460 1892 1560 1946">   M-WAVE                     </div> <div data-bbox="1476 2049 1556 2139">  </div>

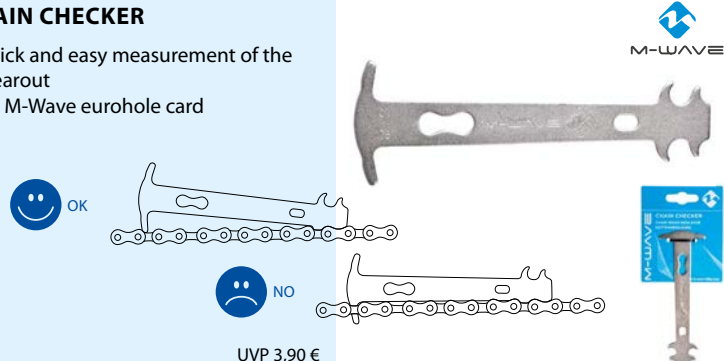

ART.-NR.	BESCHREIBUNG	DESCRIPTION	
<b>881085</b> 50/10	<b>PRESSE FÜR HYDRAULIK-LEITUNGEN ›PRESS IT‹</b> <ul style="list-style-type: none"> <li>• <b>CNC-gefräste Montagehilfe</b></li> <li>• zum einfachen und geraden Einpressen von Leitungsverbindungen</li> <li>• drehbarer Leitungsadapter, passend für <b>Shimano, Magura, Hayes, Tektro, Promax</b>, etc.</li> <li>• auf M-Wave Eurolochkarte</li> </ul> 	<b>HYDRAULIC PRESS ›PRESS IT‹</b> <ul style="list-style-type: none"> <li>• <b>CNC machined installation aid</b></li> <li>• for easy and straight pressfitting of hydraulic line connections</li> <li>• turnable adapter, for <b>Shimano, Magura, Hayes, Tektro, Promax</b>, etc.</li> <li>• on M-Wave eurohole card</li> </ul>	 
<b>880300</b> 75	<b>KABELZANGE</b> <ul style="list-style-type: none"> <li>• <b>Non-slip</b> Griff</li> <li>• <b>hochwertige Ausführung</b></li> <li>• für Züge und Hüllen</li> </ul>	<b>CABLE CUTTER</b> <ul style="list-style-type: none"> <li>• <b>non-slip</b> grip</li> <li>• <b>high quality</b></li> <li>• for cables and outer casings</li> </ul>	
<b>880421</b> 60/10	<b>ZAHNKRANZPEITSCH</b> <ul style="list-style-type: none"> <li>• mit kunststoffummanteltem Griff</li> </ul>	<b>CHAIN WHIP</b> <ul style="list-style-type: none"> <li>• with plastic covered handle</li> </ul>	
<b>880997</b> 500	<b>FREILAUFZAHNKRANZ-WERKZEUG</b> <ul style="list-style-type: none"> <li>• passend für <b>Shimano</b> 6-fach und 7-fach Hyperglide Zahnkränze und <b>Sram XD-Drive</b> (kein original Shimano oder Sram Ersatzteil)</li> <li>• für Ventura Freilaufzahnkranz Art. 700170/3</li> </ul>	<b>FREEWHEEL REMOVER</b> <ul style="list-style-type: none"> <li>• for <b>Shimano</b> 6 speed and 7 speed hyperglide freewheels and <b>Sram XD drive</b> (no original Shimano or Sram spare part)</li> <li>• for Ventura freewheel art. 700170/3</li> </ul>	
<b>880458</b> 200	<b>KASSETTENZAHNKRANZ-WERKZEUG ›TW-D1‹</b> <ul style="list-style-type: none"> <li>• mit <b>5 mm Führungsstift</b> für Schnellspannachsen</li> <li>• abnehmbarer Adapter für Naben mit <b>12 mm Steckachse</b></li> <li>• für Shimano Hyperglide-Kassette</li> <li>• für Sram XD Drive</li> <li>• zur (De-)Montage von Shimano <b>Centerlock Bremsscheiben (QR9)</b> (kein Original Shimano/Sram Ersatzteil)</li> <li>• für 1/2" Steckverbindung oder 24 mm Schlüssel</li> <li>• im Polybeutel mit M-Wave Euroloch-header</li> </ul>	<b>CASSETTE SPROCKET REMOVER ›TW-D1‹</b> <ul style="list-style-type: none"> <li>• with <b>5 mm guide pin</b> for quick release axles</li> <li>• removable adapter for hubs with <b>12 mm thru axle</b></li> <li>• for Shimano hyperglide cassette</li> <li>• für Sram XD Drive</li> <li>• for (dis-)mounting of Shimano <b>centerlock discs (QR9)</b> (no original Shimano/Sram spare part)</li> <li>• for 1/2" drive or 24 mm wrench</li> <li>• in PE bag with M-Wave eurohole header</li> </ul>	<div style="border: 1px solid black; padding: 2px; display: inline-block;"><b>3 in 1</b></div>  









ART.-NR. 	BESCHREIBUNG	DESCRIPTION	
880407 200	<b>REINIGUNGSBÜRSTE</b> <ul style="list-style-type: none"> <li>• speziell zum <b>Reinigen</b> von <b>Ketten von drei Seiten gleichzeitig</b></li> <li>• auch für andere Teile (z. B. Kassette, Umwerfer, ...)</li> <li>• stabiler Kunststoffgriff</li> <li>• im Polybeutel mit Barcode-Aufkleber</li> </ul>	<b>CLEANING BRUSH</b> <ul style="list-style-type: none"> <li>• especially for <b>cleaning chains from three sides at the same time</b></li> <li>• also for other parts (e. g. cassette, front derailleur, ...)</li> <li>• stable plastic handle</li> <li>• in PE bag with barcode sticker</li> </ul>	
880405 250	<b>REINIGUNGSBÜRSTE</b> <ul style="list-style-type: none"> <li>• stabiler Kunststoffgriff</li> <li>• zum Reinigen der Kassette oder anderer Teile (z. B. Umwerfer, ...)</li> <li>• schwarz</li> <li>• Montageverpackung</li> </ul>	<b>CLEANING BRUSH</b> <ul style="list-style-type: none"> <li>• stable plastic handle</li> <li>• for cleaning the cassette or other parts (e. g. front derailleur, ...)</li> <li>• black</li> <li>• OEM</li> </ul>	
880446 200/50	<b>KETTENMESSLEHRE</b> <ul style="list-style-type: none"> <li>• schnelles und einfaches Messen des Verschleißes</li> <li>• auf M-Wave Eurolochkarte</li> </ul>	<b>CHAIN CHECKER</b> <ul style="list-style-type: none"> <li>• quick and easy measurement of the wearout</li> <li>• on M-Wave eurohole card</li> </ul>	
880031 60	<b>KETTENNIETDRÜCKER</b> <b>›PIN PUSHER PAUL‹</b> <ul style="list-style-type: none"> <li>• <b>hochwertige Ausführung</b></li> <li>• kunststoffummantelter <b>Non-Slip</b> Griff</li> <li>• mit <b>Kettenhalter</b> zur einfacheren Montage</li> <li>• <b>Ersatzstift</b> durch <b>drehbaren</b> Nietstift</li> <li>• Ersatzstift (Art. 880032) separat erhältlich</li> <li>• auf M-Wave Eurolochkarte</li> </ul>	<b>CHAIN RIVETING TOOL</b> <b>›PIN PUSHER PAUL‹</b> <ul style="list-style-type: none"> <li>• <b>high quality</b></li> <li>• plastic coated <b>non-slip</b> handle</li> <li>• with <b>chain keeper</b> for easier mounting</li> <li>• <b>replacement bolt</b> by <b>turnable</b> riveting bolt</li> <li>• replacement bolt (art. 880032) separately available</li> <li>• on M-Wave eurohole card</li> </ul>	
880460 100	<b>KETTENNIETDRÜCKER</b> <ul style="list-style-type: none"> <li>• für 1-<b>12-fach</b> Ketten</li> <li>• ergonomische Form</li> <li>• Stift austauschbar</li> <li>• mit <b>Ersatzstift</b></li> <li>• auf Ventura Eurolochkarte</li> </ul>	<b>CHAIN RIVETING TOOL</b> <ul style="list-style-type: none"> <li>• for 1-<b>12 speed</b> chains</li> <li>• ergonomic shape</li> <li>• exchangeable pin</li> <li>• with <b>replacement pin</b></li> <li>• on Ventura eurohole card</li> </ul>	
880099 200	<b>KETTENNIETDRÜCKER</b> <ul style="list-style-type: none"> <li>• für 1-<b>12-fach</b> Ketten</li> <li>• für Shimano HG - Ketten (kein original Shimano Ersatzteil)</li> <li>• Montageverpackung</li> </ul>	<b>CHAIN RIVETING TOOL</b> <ul style="list-style-type: none"> <li>• for 1-<b>12 speed</b> chains</li> <li>• for Shimano HG - chains (no original Shimano spare part)</li> <li>• OEM</li> </ul>	
880441 100	<b>KETTENNIETDRÜCKER</b> <ul style="list-style-type: none"> <li>• einfache, robuste Ausführung</li> <li>• für <b>1 - 11-fach Ketten</b></li> <li>• Montageverpackung</li> </ul>	<b>CHAIN RIVETING TOOL</b> <ul style="list-style-type: none"> <li>• simple, robust design</li> <li>• for <b>1 - 11 speed chains</b></li> <li>• OEM</li> </ul>	

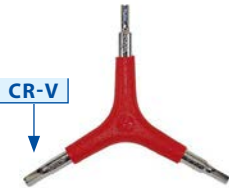

ART.-NR. 	BESCHREIBUNG	DESCRIPTION	
<b>880021</b> 150/30	<b>SPEICHENLINEAL</b> <ul style="list-style-type: none"> <li>aus <b>Edelstahl</b></li> <li>für <b>präzises</b> Messen der Speichenlänge und <b>Nippelgröße</b></li> <li>in Einschiebhülle aus Kunststoff</li> </ul>	<b>SPOKE RULER</b> <ul style="list-style-type: none"> <li>made of <b>stainless steel</b></li> <li>for <b>precise</b> measuring of the spoke length and <b>nipple size</b></li> <li>in slide-in cover made of plastic</li> </ul> 	<div style="display: flex; justify-content: space-between; align-items: center;"> <div style="border: 1px solid black; padding: 2px; font-weight: bold;">PROFI QUALITÄT</div>  </div>  <p style="text-align: right;">UVP 10,90 €</p>
<b>880358</b> 100	<b>NIPPELDREHER-BIT</b> <ul style="list-style-type: none"> <li>Schlitznippeldreher-Bit mit Pin für <b>Elektroschrauber</b></li> <li>ermöglicht ein <b>superschnelles und einfaches Ein-/Auspeichen</b></li> <li>aus stabilem Carbonstahl, verchromt</li> <li>Montageverpackung</li> </ul>	<b>SPOKE WRENCH BIT</b> <ul style="list-style-type: none"> <li>slit nipple wrench bit with pin for <b>electric screwdriver</b></li> <li>provides <b>extremely fast and easy wheel set manufacturing</b></li> <li>made of solid carbon steel, c.p.</li> <li>OEM</li> </ul> 	 <p style="text-align: right;">UVP 4,90 €</p>
<b>880266</b> 12	<b>DIGITALER DREHMOMENT-SCHLÜSSEL ›TORQUE ALARM‹</b> <ul style="list-style-type: none"> <li><b>sehr hochwertige</b> Ausführung</li> <li>genaue Einteilung von <b>3 - 60 Nm</b></li> <li><b>2 % Genauigkeit</b></li> <li>verschiedene Messeinheiten einstellbar</li> <li>mit <b>Signalton</b> beim Erreichen des eingestellten Drehmoments</li> <li><b>umschaltbare</b> Knarre (3/8") mit <b>Richtungswechsel</b></li> <li><b>Drehmomentauslösung in beide Richtungen</b></li> <li>3/8" Adapter für Bits</li> <li>Bits mit 3/4/5/6/8/10 mm Innensechskant</li> <li>T 25, T 30 und T 40 Vielzahnschlüssel</li> <li>Kreuzschraubendreher</li> <li>8/9/10/11/12/13/14/15 mm Nüsse</li> <li>inkl. Batterie (1 x AAA)</li> <li>im Hardcase mit M-Wave Banderole</li> </ul>	<b>DIGITAL TORQUE WRENCH ›TORQUE ALARM‹</b> <ul style="list-style-type: none"> <li><b>very high quality</b></li> <li>exact scale from <b>3 - 60 Nm</b></li> <li><b>2 % accuracy</b></li> <li>various measure units adjustable</li> <li>with <b>acoustic signal</b> by achievement of the adjusted torque</li> <li><b>reversible</b> ratchet (3/8") with <b>changeable direction</b></li> <li><b>torque release in both directions</b></li> <li>3/8" adapter for bits</li> <li>hex bits 3/4/5/6/8/10 mm allen key</li> <li>T 25, T 30 and T 40 star screwdriver</li> <li>Phillips screwdriver</li> <li>8/9/10/11/12/13/14/15 mm nuts</li> <li>incl. battery (1 x AAA)</li> <li>in hardcase with M-Wave banderole</li> </ul> 	 <p style="text-align: right;">UVP 259,00 €</p>
<b>880291</b> 25	<b>DREHMOMENTSCHLÜSSEL ›TW-4/24‹</b> <ul style="list-style-type: none"> <li><b>hochwertige</b> Ausführung</li> <li>genaue Einteilung von <b>4 - 24 Nm</b></li> <li>Einstellung <b>fixierbar</b></li> <li><b>umschaltbare</b> Knarre (1/4") mit <b>Richtungswechsel</b></li> <li>Bits mit 3/4/5/6/8 mm Innensechskant, T 25 und T 10 Vielzahnschlüssel</li> <li>mit <b>anatomisch geformtem 2-Komponenten Griff</b></li> <li>im Hardcase mit M-Wave Banderole</li> </ul>	<b>TORQUE WRENCH ›TW-4/24‹</b> <ul style="list-style-type: none"> <li><b>high quality</b></li> <li>exact scale from <b>4 - 24 Nm</b></li> <li>torque value <b>fixable</b></li> <li><b>reversible</b> ratchet (1/4") with <b>changeable direction</b></li> <li>hex bits 3/4/5/6/8 mm allen key, T 25 and T 10 star screwdriver</li> <li>with <b>anatomically shaped 2 components grip</b></li> <li>in hardcase with M-Wave banderole</li> </ul> 	<div style="display: flex; justify-content: space-between; align-items: center;"> <div style="border: 1px solid black; padding: 2px; font-weight: bold;">aktiv Rad Fahren</div>  </div> <div style="border: 1px solid black; padding: 2px; font-weight: bold; margin-top: 5px;">PREIS/LEISTUNG</div> <p style="font-size: 8px; margin-top: 2px;">5/2022</p> <p style="text-align: right;">UVP 83,90 €</p>



ART.-NR.	BESCHREIBUNG	DESCRIPTION	
<b>880275</b> 20	<b>DREHMOMENTSCHLÜSSEL</b> <ul style="list-style-type: none"> <li>• <b>hochwertige</b> Ausführung</li> <li>• genaue Einteilung von <b>2 - 24 Nm</b></li> <li>• <b>umschaltbare</b> Knarre (¼") mit <b>Richtungswechsel</b></li> <li>• Bits mit 3/4/5/6/8/10 mm Innen-sechskant</li> <li>• 5 mm Innensechskant mit Verlänge-rung</li> <li>• T 20, T 25 und T 30 Vielzahnschlüssel</li> <li>• im Hardcase mit Mighty Banderole</li> </ul>	<b>TORQUE WRENCH</b> <ul style="list-style-type: none"> <li>• <b>high quality</b></li> <li>• exact scale from <b>2 - 24 Nm</b></li> <li>• <b>reversible</b> ratchet (¼") with <b>changeable direction</b></li> <li>• hex bits 3/4/5/6/8/10 mm allen key</li> <li>• 5 mm allen key with extension</li> <li>• T 20, T 25 and T 30 star screwdriver</li> <li>• in hardcase with Mighty banderole</li> </ul>	 <p style="text-align: right;">UVP 83,90 €</p>
<b>880293</b> 100/25	<b>DREHMOMENTSCHLÜSSEL ›TW-3/10‹</b> <ul style="list-style-type: none"> <li>• <b>3 - 10 Nm</b></li> <li>• Bits mit 3/4/5/6 mm Innensechskant, T 25 Vielzahnschlüssel, Kreuz-schraubendreher</li> <li>• in M-Wave Blisterverpackung</li> </ul>	<b>TORQUE WRENCH ›TW-3/10‹</b> <ul style="list-style-type: none"> <li>• <b>3 - 10 Nm</b></li> <li>• hex bits 3/4/5/6 mm allen key, T 25 star screwdriver, Phillips screwdriver</li> <li>• in M-Wave blister packaging</li> </ul>	 <p style="text-align: right;">UVP 15,90 €</p>
<b>880264</b> 30	<b>BIT-SET ›ADAPT 1/4‹</b> <ul style="list-style-type: none"> <li>• mit <b>Adapter von ¼" Vierkant auf ¼" Sechskant</b></li> <li>• Dadurch können Sie <b>alle gängigen ¼" Sechskantbits mit unserem Drehmomentschlüssel verwenden.</b></li> <li>• Bits mit 2,5/3/4/5/6 mm Innen-sechskant</li> <li>• T 10/20/25 Vielzahnschlüssel</li> <li>• Kreuzschraubendreher 1/2</li> <li>• in M-Wave Eurolochbox</li> </ul>	<b>BIT SET ›ADAPT 1/4‹</b> <ul style="list-style-type: none"> <li>• with <b>adapter from ¼" square to ¼" hex</b></li> <li>• This allows you to <b>use all current ¼" hex bits with our torque wrench.</b></li> <li>• hex bits 2,5/3/4/5/6 mm allen key</li> <li>• T 10/20/25 star screwdriver</li> <li>• Phillips screwdriver 1/2</li> <li>• in M-Wave eurohole box</li> </ul>	 <p style="text-align: right;">UVP 6,90 €</p>
<b>880970</b> 60/10 set	<b>INNENVIELZAHN-SCHLÜSSEL-SATZ</b> <ul style="list-style-type: none"> <li>• <b>T10, T15, T20, T25, T27, T30, T40, T45, T50 an beiden Enden</b></li> <li>• aus <b>Chrom-Vanadium-Stahl</b></li> <li>• durch Vertiefung in der Mitte <b>für Sicherheitsschrauben geeignet</b></li> <li>• auf Ventura Eurolochkarte</li> </ul>	<b>STAR SCREWDRIVER SET</b> <ul style="list-style-type: none"> <li>• <b>T10, T15, T20, T25, T27, T30, T40, T45, T50 at both ends</b></li> <li>• made of <b>chrome vanadium steel</b></li> <li>• <b>suitable for security screws</b> by deepening in the middle</li> <li>• on Ventura eurohole card</li> </ul>	 <p style="text-align: right;">UVP 9,80 €</p>
<b>880906</b> 60/10 set	<b>INNENSECHSKANT-SCHLÜSSEL-SET</b> <ul style="list-style-type: none"> <li>• 1.5/2/2.5/3/4/5/6/8/10 mm mit Kunststoffhalter</li> <li>• aus <b>Chrom-Vanadium Stahl</b></li> <li>• mit <b>kurzem, geradem Ende und langem Kugelkopfende</b></li> <li>• in Blisterverpackung</li> </ul>	<b>ALLEN KEY SET</b> <ul style="list-style-type: none"> <li>• 1.5/2/2.5/3/4/5/6/8/10 mm with plas-tic holder</li> <li>• <b>chrome vanadium steel</b></li> <li>• with <b>short, straight end and long ball head</b></li> <li>• in blister packaging</li> </ul>	 <p style="text-align: right;">UVP 8,90 €</p>







ART.-NR. 	BESCHREIBUNG	DESCRIPTION	
<b>880900</b> 200	<b>DREIARMSCHLÜSSEL</b> • Bits aus <b>Chrom-Vanadiumstahl</b> • <b>Innensechskant</b> 4/5/6 mm • mit kunststoffüberzogenem Griff	<b>THREE ARM WRENCH</b> • bits made of <b>chrome vanadium steel</b> • <b>allen key</b> 4/5/6 mm • with hard PP cover	 UVP 3,90 €
<b>880932</b> 200/50 set	<b>INNENVIELZAHN-SCHLÜSSEL-SATZ</b> • <b>T10, T15, T20, T25, T30</b> an <b>beiden Enden</b> • durch Vertiefung in der Mitte für <b>Sicherheitsschrauben geeignet</b> • verzinkt • auf Ventura Eurolochkarte	<b>STAR SCREWDRIVER SET</b> • <b>T10, T15, T20, T25, T30</b> at <b>both ends</b> • <b>suitable for security screws</b> by deepening in the middle • zinc plated • on Ventura eurohole card	 UVP 2,90 €
• <b>880909</b> 200/50 set	<b>WERKZEUG-SET</b> bestehend aus • Innensechskantschlüsseln 4, 5, 6 mm • Vielzahnschlüssel T25 • Pedalschlüssel 15 mm • verzinkt • im Polybeutel mit Aufkleber	<b>TOOL SET</b> consisting of • allen keys 4, 5, 6 mm • star screwdriver T25 • pedal wrench 15 mm • zinc plated • in PE bag with sticker	 UVP 2,50 €
<b>880904</b> 200 set	<b>INNENSECHSKANT-SCHLÜSSELSET</b> • 2/3/4/5/6/7 mm • im Polybeutel mit Aufkleber	<b>ALLEN KEY SET</b> • 2/3/4/5/6/7 mm • in PE bag with sticker	 UVP 1,90 €
<b>880923</b> 200/10	<b>KOPFSCHLÜSSEL</b> • <b>10-Loch</b> • Schraubengröße 6 - 15 mm • <b>hochwertige stabile Ausführung</b> • Montageverpackung	<b>HEAD KEY</b> • <b>10 holes</b> • screw size 6 - 15 mm • <b>high quality stable version</b> • OEM	 UVP 1,90 €
<b>880267</b> 800	<b>REIFENFLICK-SET</b> >TUBELESS FIX< • in hochwertigem <b>Aluminium</b> Gehäuse • 2 Funktionen: Reifen Reibahle und Einführwerkzeug • verschieden dicke Streifen für kleine und große Löcher: 5 x Ø 1,5 mm 3 x Ø 3,5 mm • Gehäuse dient bei Verwendung als Hebel • auf M-Wave Eurolochkarte	<b>TUBELESS REPAIR KIT</b> >TUBELESS FIX< • in high quality <b>aluminium</b> case • 2 functions: tire reamer and insert tool • stripes in different widths for small and big holes: 5 x Ø 1.5 mm 3 x Ø 3.5 mm • case useable as lever • on M-Wave eurohole card	 UVP 15,90 €
<b>880368</b> 250 set	<b>REPARATURSET</b> in Kunststoff-Box, bestehend aus: • <b>2 Reifenheber</b> • 1 Tube Vulkanisierlösung (10 ml / 6,5 g) • 2 Flicker Ø 26 mm • 4 Flicker 25 x 34 mm • 1 Flicker 34 x 51 mm • 1 Sandpapier • 1 Ventilschlauch • Arbeitsanleitung	<b>REPAIR SET</b> set in a box, consisting of: • <b>2 tire levers</b> • 1 tube solution (10 ml / 6.5 g) • 2 patches Ø 26 mm • 4 patches 25 x 34 mm • 1 patch 34 x 51 mm • 1 sand paper • 1 valve tube • instruction	 UVP 2,90 €
<b>880162</b> 500 set	<b>REPARATURSET</b> in Kunststoff-Box, bestehend aus: • 1 Tube Vulkanisierlösung (10 ml / 6,5 g) • 2 Flicker Ø 26 mm • 4 Flicker 25 x 34 mm • 1 Flicker 34 x 51 mm • 1 Sandpapier • 1 Ventilschlauch • Arbeitsanleitung	<b>REPAIR SET</b> set in a box, consisting of: • 1 tube solution (10 ml / 6.5 g) • 2 patches Ø 26 mm • 4 patches 25 x 34 mm • 1 patch 34 x 51 mm • 1 sand paper • 1 valve tube • instruction	 UVP 1,90 €

ART.-NR. 	BESCHREIBUNG	DESCRIPTION	
<b>880002</b> 48	<b>REIFENMONTIERZANGE</b> <ul style="list-style-type: none"> <li>• <b>Montagehilfe</b>, besonders geeignet für schwierige Reifen-/Felgen-Kombinationen</li> <li>• besonders effektiv durch große <b>Hebelwirkung</b></li> <li>• aus hochwertigem Kunststoff</li> <li>• auf M-Wave Eurolochkarte</li> </ul>	<b>WHEEL MOUNT PLIERS</b> <ul style="list-style-type: none"> <li>• <b>installation aid</b>, particularly suitable for complex tire to wheel combinations</li> <li>• particularly effective with great <b>leverage</b></li> <li>• made of high quality plastic</li> <li>• on M-Wave eurohole card</li> </ul>	
<b>880462</b> 50	<b>MULTITOOL ›CHAIN AID‹</b> <ul style="list-style-type: none"> <li>• <b>5 in 1</b></li> <li>• Reifenheber</li> <li>• Kettenschlossaufbewahrung (Kettenschloss nicht im Lieferumfang enthalten)</li> <li>• Kettenhalter</li> <li>• Repair Chain Drop</li> <li>• Ventileinsatzwerkzeug für FV</li> </ul>	<b>MULTITOOL ›CHAIN AID‹</b> <ul style="list-style-type: none"> <li>• <b>5 in 1</b></li> <li>• tire lever</li> <li>• missing link storage (missing link not included)</li> <li>• chain latch</li> <li>• repair chain drop</li> <li>• valve core tool for FV</li> </ul>	<b>5 in 1</b> 
<b>880390</b> 100/25 pair	<b>REIFENHEBER</b> <ul style="list-style-type: none"> <li>• <b>hochwertiger Kunststoff: stabil und schonend</b></li> <li>• <b>extra lange</b> Ausführung</li> <li>• fast <b>unzerbrechlich</b></li> <li>• paarweise auf M-Wave Eurolochkarte</li> </ul>	<b>TIRE LEVERS</b> <ul style="list-style-type: none"> <li>• <b>high quality plastic: stable and gentle</b></li> <li>• <b>extra long</b> version</li> <li>• almost <b>unbreakable</b></li> <li>• one pair on M-Wave eurohole card</li> </ul>	
<b>880262</b> 1.000 set	<b>REIFENHEBER ›TP-L1‹</b> <ul style="list-style-type: none"> <li>• aus stabilem Kunststoff</li> <li>• 1 Set = <b>3 Stück</b></li> <li>• mit <b>2-fach Haken</b> zum Einhängen in die Speichen</li> <li>• auf M-Wave Eurolochkarte</li> </ul>	<b>TIRE LEVER ›TP-L1‹</b> <ul style="list-style-type: none"> <li>• made of stable plastic</li> <li>• 1 set = <b>3 pieces</b></li> <li>• with <b>double hook</b> for fixation at the spokes</li> <li>• on M-Wave eurohole card</li> </ul>	
<b>880018</b> 500 set	<b>REIFENHEBER</b> <ul style="list-style-type: none"> <li>• aus stabilem Kunststoff</li> <li>• 1 Set = <b>3 Stück</b></li> <li>• mit <b>2-fach Haken</b> zum Einhängen in die Speichen</li> <li>• Montageverpackung</li> </ul>	<b>TIRE LEVER</b> <ul style="list-style-type: none"> <li>• made of stable plastic</li> <li>• 1 set = <b>3 pieces</b></li> <li>• with <b>double hook</b> for fixation at the spokes</li> <li>• OEM</li> </ul>	
<b>880253</b> 20 set	<b>GEWINDESCHNEIDE-SET ›CUT 10‹</b> 10-teilig <ul style="list-style-type: none"> <li>• M 4 x 0,70</li> <li>• M 5 x 0,80</li> <li>• M 6 x 1,00</li> <li>• M 8 x 1,25</li> <li>• M 10 x 1,00</li> <li>• Pedalgewindeschneider 9/16" (links &amp; rechts)</li> <li>• Pedalgewindeschneider 1/2" (links &amp; rechts)</li> <li>• inkl. Windeisen</li> <li>• in Tasche mit M-Wave Banderole</li> </ul>	<b>THREAD CUTTING SET ›CUT 10‹</b> 10-piece <ul style="list-style-type: none"> <li>• M 4 x 0.70</li> <li>• M 5 x 0.80</li> <li>• M 6 x 1.00</li> <li>• M 8 x 1.25</li> <li>• M 10 x 1.00</li> <li>• pedal thread cutter 9/16" (left &amp; right)</li> <li>• pedal thread cutter 1/2" (left &amp; right)</li> <li>• incl. turning bracket</li> <li>• in bag with M-Wave banderole</li> </ul>	



ART.-NR. 	BESCHREIBUNG	DESCRIPTION	
<b>880050</b> 5	<b>FAHRRAD-WERKZEUGKOFFER ›PORTABLE CLINIC‹</b> <b>"alles in einem", 43-teilig</b> <ul style="list-style-type: none"> <li>• Flickzeug</li> <li>• 2 Flach- und 2 Kreuzschraubenzieher</li> <li>• Zahnkranzabzieher</li> <li>• kleiner Schraubenzieher (für die Schaltungseinstellung)</li> <li>• Gabelschlüssel 8/10 mm</li> <li>• Zahnkranzschlüssel mit Kette</li> <li>• Steuersatzschlüssel 30/32 + 36/40 mm</li> <li>• Konusschlüssel 13/15 + 14/16 mm</li> <li>• Kurbelabzieher</li> <li>• Nippelspanner 10/11/12/13/14/15G</li> <li>• Innensechskant-Schlüsselset 2/2,5/3/4/5/6 mm (bei 4/5/6 mm Innensechskant-Kugelende)</li> <li>• verstellbarer Tretlagerschlüssel</li> <li>• Pedalarm Schlüsselschlüssel 15/16 + 15/17 mm</li> <li>• Tretlagerwerkzeug</li> <li>• verstellbarer Gabelschlüssel, 0 - 21 mm</li> <li>• Kettennietdrücker</li> <li>• 8 mm Innensechskantschlüssel (für Kurbelabzieher)</li> <li>• 3 Reifenheber</li> <li>• 6/8/9/10 mm Sechskant</li> <li>• mit M-Wave Banderole</li> </ul>	<b>BICYCLE TOOL CASE ›PORTABLE CLINIC‹</b> <b>"all in one", 43 pcs.</b> <ul style="list-style-type: none"> <li>• repair kit</li> <li>• 2 flat and 2 Phillips screwdriver</li> <li>• freewheel remover</li> <li>• small screwdriver (for derailleur adjustment)</li> <li>• forged open-ended wrench 8/10 mm</li> <li>• freewheel turner with chain whip</li> <li>• headset wrench 30/32 + 36/40 mm</li> <li>• cone wrenches 13/15 + 14/16 mm</li> <li>• cotterless crankarm extractor</li> <li>• spoke adjuster 10/11/12/13/14/15G</li> <li>• allen key set 2/2.5/3/4/5/6 mm (at 4/5/6 mm ball end)</li> <li>• adjustable bottom bracket tool</li> <li>• pedal wrench 15/16 + 15/17 mm</li> <li>• cartridge bottom bracket tool</li> <li>• adjustable forged steel wrench, 0 - 21 mm</li> <li>• chain riveting tool</li> <li>• 8 mm allen key wrench (for crankarm removal)</li> <li>• 3 tire levers</li> <li>• 6/8/9/10 mm hexagonal</li> <li>• with M-Wave banderole</li> </ul> <p style="text-align: right;">UVP 129,00 €</p>	  
<b>881066</b> 5	<b>FAHRRAD-UNIVERSAL-WERKZEUGKOFFER ›ALL IN ONE‹</b> <b>37-teilig, mit Banderole</b> <ul style="list-style-type: none"> <li>• Zahnkranzabzieher</li> <li>• Zahnkranzschlüssel mit Kette</li> <li>• Steuersatzschlüssel 30/32 + 36/40 mm</li> <li>• Konusschlüssel 13/15 + 14/16 mm</li> <li>• Pedalarm Schlüsselschlüssel 15/16 + 15/17 mm</li> <li>• Kurbelabzieher</li> <li>• Nippelspanner 10/11/12/13/14/15G</li> <li>• Innensechskant-Schlüssel-Set 1.5/2/2.5/3/4/5/5.5/6 mm</li> <li>• Knebel 1/4"</li> <li>• 8/9/10 mm Nüsse</li> <li>• Bits (2x Kreuzschlitz, 2x Längsschlitz)</li> <li>• magnetischer Schlitzschraubendreher</li> <li>• 8 mm Innensechskantschlüssel mit 1/2" Adapter</li> <li>• Innenlagerschlüssel</li> <li>• verstellbarer Tretlagerschlüssel</li> <li>• Tretlagerwerkzeug</li> <li>• Innenlager-Werkzeug</li> <li>• Kettennietdrücker</li> <li>• Reifendruck-Messstift</li> <li>• 3 Reifenheber</li> <li>• Flickzeug</li> <li>• mit Ventura Banderole</li> </ul>	<b>UNIVERSAL BICYCLE TOOL CASE ›ALL IN ONE‹</b> <b>37 pieces, with banderole</b> <ul style="list-style-type: none"> <li>• freewheel remover</li> <li>• freewheel turner with chain whip</li> <li>• headset wrench 30/32 + 36/40 mm</li> <li>• cone wrenches 13/15 + 14/16 mm</li> <li>• pedal wrench 15/16 + 15/17 mm</li> <li>• cotterless crankarm extractor</li> <li>• spoke adjuster 10/11/12/13/14/15G</li> <li>• allen key set 1.5/2/2.5/3/4/5/5.5/6 mm</li> <li>• L handle 1/4"</li> <li>• 8/9/10 mm nuts</li> <li>• Bits (2x Phillips, 2x slotted)</li> <li>• magnetic slotted screwdriver</li> <li>• 8 mm allen key wrench with 1/2" adapter</li> <li>• lock ring tool</li> <li>• adjustable bottom bracket tool</li> <li>• cartridge bottom bracket tool</li> <li>• bottom bracket tool</li> <li>• chain riveting tool</li> <li>• tire pressure measurement pen</li> <li>• 3 tire levers</li> <li>• repair kit</li> <li>• with Ventura banderole</li> </ul> <p style="text-align: right;">UVP 74,90 €</p>	  
<b>880314</b> 50	<b>MULTIFUNKTIONSZANGE ›MULTITOOL 8 IN 1‹</b> <ul style="list-style-type: none"> <li>• 8 in 1: acht Funktionen in einem Werkzeug</li> <li>• Zange zum <b>Öffnen und Verschießen</b> von <b>Kettenverschlussgliedern</b></li> <li>• magnetischer Halter für Kettenverschlussglieder</li> <li>• <b>Außenhüllen- und Innenzug-Schneider</b></li> <li>• <b>Außenhüllenaufweiter</b></li> <li>• <b>Presse für Außenhüllen-Endkappen und Zugendhülsen</b></li> <li>• <b>Non-Slip</b> Griff</li> <li>• auf Ventura Eurolochkarte</li> </ul>	<b>MULTIFUNCTIONAL PLIERS ›MULTITOOL 8 IN 1‹</b> <ul style="list-style-type: none"> <li>• 8 in 1: eight functions in one tool</li> <li>• pliers for <b>unlocking and locking</b> of <b>connecting links</b></li> <li>• magnetic holder for connecting links</li> <li>• <b>outer and inner cable cutter</b></li> <li>• <b>outer cable expander</b></li> <li>• <b>press for outer housing end caps and inner cable end caps</b></li> <li>• <b>non-slip</b> grip</li> <li>• on Ventura eurohole card</li> </ul> <p style="text-align: right;">UVP 26,90 €</p>	<div style="border: 1px solid black; padding: 2px; display: inline-block;"><b>8 in 1</b></div>   



ART.-NR. 	BESCHREIBUNG	DESCRIPTION	
<p><b>122290</b> 50</p>	<p><b>REPARATUR-SET</b> bestehend aus:</p> <p><b>Satteltasche</b> (Art. 122353) • Befestigung mit Klettverschluss an Sattel, Rahmenrohr, ... • ca. 140 x 85 x 50 mm • mit Reflexlogo</p> <p><b>Mini-Faltwerkzeug</b> (Art. 880940) 11 Funktionen • 2/2,5/3/4/5/6/8 mm Stahl-Innensechskant • 1 Schlitzschraubendreher • 1 Kreuzschraubendreher • 1 Kettennietdrücker • T 25 Vielzahnschlüssel • mit Nylontasche</p> <p><b>Flickzeugset</b> (Art. 880162) • 1 Tube Vulkanisierlösung (10 ml / 6,5 g) • 2 Flicken Ø 26 mm • 4 Flicken 25 x 34 mm • 1 Flicken 34 x 51 mm • 1 Sandpapier • 1 Ventilschlauch • Arbeitsanleitung • in Kunststoffbox</p> <p><b>Reifenheber</b> (Art. 880018) • Kunststoff • 3 Stück im Set</p> <p>auf Ventura Eurolochkarte</p>	<p><b>REPAIR KIT</b> consisting of:</p> <p><b>saddle bag</b> (art. 122353) • fixing with hook and loop fastener at saddle, frame tubes, ... • approx. 140 x 85 x 50 mm • with reflex logo</p> <p><b>Mini Folding Tool</b> (art. 880940) 11 functions • 2/2.5/3/4/5/6/8 mm steel allen key • 1 flat screwdriver • 1 Phillips screwdriver • 1 chain riveting tool • T 25 star screwdriver • with nylon bag</p> <p><b>Repair Kit</b> (art. 880162) • 1 tube solution (10 ml / 6.5 g) • 2 patches Ø 26 mm • 4 patches 25 x 34 mm • 1 patch 34 x 51 mm • 1 sand paper • 1 valve tube • instruction • in box</p> <p><b>Tire Levers</b> (art. 880018) • plastic • 3 pieces in a set</p> <p>on Ventura eurohole card UVP 17,90 €</p>	 <p><b>VENTURA®</b> BIKE + OUTDOOR</p>
<p><b>880920</b> 50/25</p> <p><b>TIP</b></p>	<p><b>MINI-FALTWERKZEUG ›LITTLE 15‹</b> <b>15 Funktionen</b> • 2/2,5/3/4/5/6/8 mm Innensechskantschlüssel • Kreuz- und Schlitzschraubendreher • <b>Kettennietdrücker</b> • Speichenschlüssel 3,2/3,3/3,5/4 • T 25 Vielzahnschlüssel • auf M-Wave Eurolochkarte</p>	<p><b>MINI FOLDING TOOL ›LITTLE 15‹</b> <b>15 functions</b> • 2/2.5/3/4/5/6/8 mm allen key • Phillips and flat type screwdriver • <b>chain riveting tool</b> • spoke adjuster 3.2/3.3/3.5/4 • T 25 star screwdriver • on M-Wave eurohole card</p> <p>UVP 22,90 €</p>	 <p><b>M-WAVE</b></p> <p><b>aktiv Radfahren</b> PREIS/LEISTUNG 6/2019</p>
<p><b>880955</b> 100/25</p>	<p><b>MINI-FALTWERKZEUG ›LITTLE 12‹</b> <b>12 Funktionen</b> Werkzeuge aus <b>Chrom-Vanadium-Stahl</b> • 2/3/4/5/6 mm Innensechskant • T 25 Vielzahnschlüssel • 2 Schraubenzieher • 4 Nippelspanner • nur <b>78 g</b> • auf M-Wave Eurolochkarte</p>	<p><b>MINI FOLDING TOOL ›LITTLE 12‹</b> <b>12 functions</b> Tools made of <b>chrome vanadium steel</b> • 2/3/4/5/6 mm allen key • T 25 star screwdriver • 2 screwdrivers • 4 spoke adjusters • only <b>78 g</b> • on M-Wave eurohole card UVP 14,90 €</p>	 <p><b>M-WAVE</b></p>
<p><b>408231</b> 40/20 pair</p>	<p><b>LENKERZUSATZGRIFF ›BE TOOL‹</b> • <b>Aluminium</b> • mattschwarz • <b>Werkzeugset</b> im Inneren mit <b>15 Funktionen:</b> 4/5/6/8 mm Innensechskantschlüssel T 25 Vielzahnschlüssel 14G/0,136" Speichenschlüssel Kreuz-/Schlitzschraubendreher 8/9/10 mm Ring-/Maulschlüssel <b>Kettennietdrücker</b> 2 Reifenheber • in M-Wave Blisterverpackung</p>	<p><b>BAR END ›BE TOOL‹</b> • <b>aluminium</b> • matt black • <b>tool set inside with 15 functions:</b> 4/5/6/8 mm allen key T 25 star screwdriver 14G/0.136" spoke wrench Phillips/flat screwdriver 8/9/10 mm round wrench <b>chain riveting tool</b> 2 tire levers • in M-Wave blister packaging</p> <p>UVP 18,90 €</p>	<p>according to ISO 4210</p>  <p><b>M-WAVE</b></p>





ART.-NR. 	BESCHREIBUNG	DESCRIPTION	
<b>880938</b> 72/12	<b>MINI-FALTWERKZEUG</b> <b>18 Funktionen</b> <ul style="list-style-type: none"> <li>• 2/2,5/3/4/5/6/8 mm Innensechskant</li> <li>• 2 Schraubenzieher</li> <li>• 1 <b>Kettennietdrücker</b></li> <li>• 8/9/10/13/14/15 mm Schraubenschlüssel</li> <li>• 2 Nippelspanner</li> <li>• separater 5 mm Innensechskant</li> <li>• inkl. <b>Tasche</b> mit Gürtelschlaufe</li> <li>• in Ventura Blisterverpackung</li> </ul>	<b>MINI FOLDING TOOL</b> <b>18 functions</b> <ul style="list-style-type: none"> <li>• 2/2.5/3/4/5/6/8 mm allen key</li> <li>• 2 screwdrivers</li> <li>• 1 <b>chain riveting tool</b></li> <li>• 8/9/10/13/14/15 mm wrench</li> <li>• 2 spoke adjusters</li> <li>• separate 5 mm allen key</li> <li>• incl. <b>pocket</b> with belt loop</li> <li>• in Ventura blister packaging</li> </ul> <p>UVP 11,90 €</p>	 <p>VENTURA® BIKE + OUTDOOR</p>
<b>880940</b> 100	<b>MINI-FALTWERKZEUG</b> <b>11 Funktionen</b> <ul style="list-style-type: none"> <li>• 2/2,5/3/4/5/6/8 mm <b>Stahl</b>-Innensechskant</li> <li>• 1 Schlitzschraubendreher</li> <li>• 1 Kreuzschraubendreher</li> <li>• 1 <b>Kettennietdrücker</b></li> <li>• T 25 Vielzahn Schlüssel</li> <li>• mit Nylontasche</li> <li>• nur <b>193 g</b></li> <li>• auf Ventura Eurolochkarte</li> </ul>	<b>MINI FOLDING TOOL</b> <b>11 functions</b> <ul style="list-style-type: none"> <li>• 2/2.5/3/4/5/6/8 mm <b>steel</b> allen key</li> <li>• 1 flat screwdriver</li> <li>• 1 Phillips screwdriver</li> <li>• 1 <b>chain riveting tool</b></li> <li>• T 25 star screwdriver</li> <li>• with nylon bag</li> <li>• only <b>193 g</b></li> <li>• on Ventura eurohole card</li> </ul> <p>UVP 8,90 €</p>	 <p>VENTURA® BIKE + OUTDOOR</p> <p>193 g</p>
<b>880941</b> 100/50	<b>MINI-FALTWERKZEUG</b> <ul style="list-style-type: none"> <li>• <b>Carbon</b>-Seitenteile</li> <li>• 2/3/4/5/6 mm Innensechskant</li> <li>• 1 Schlitzschraubendreher</li> <li>• 1 Kreuzschraubendreher</li> <li>• nur <b>59 g</b></li> <li>• inkl. Tasche mit Gürtelschlaufe</li> <li>• auf M-Wave Eurolochkarte</li> </ul>	<b>MINI FOLDING TOOL</b> <ul style="list-style-type: none"> <li>• <b>Carbon</b> sides</li> <li>• 2/3/4/5/6 mm allen key</li> <li>• 1 flat screwdriver</li> <li>• 1 Phillips screwdriver</li> <li>• only <b>59 g</b></li> <li>• incl. pocket with belt loop</li> <li>• on M-Wave eurohole card</li> </ul> <p>UVP 7,90 €</p>	 <p>M-WAVE</p> <p>59 g</p> <p>CARBON</p>
<b>880957</b> 100	<b>FALTWERKZEUG</b> <ul style="list-style-type: none"> <li>• <b>T20</b> und <b>T25</b> Vielzahn Schlüssel</li> <li>• 2/3/4/5/6/8 mm Innensechskant</li> <li>• 1 Schlitzschraubendreher</li> <li>• 1 Kreuzschraubendreher</li> </ul>	<b>FOLDING TOOL</b> <ul style="list-style-type: none"> <li>• <b>T20</b> and <b>T25</b> star screwdriver</li> <li>• 2/3/4/5/6/8 mm allen key</li> <li>• 1 flat screwdriver</li> <li>• 1 Phillips screwdriver</li> </ul> <p>UVP 3,90 €</p>	
<b>880903</b> 150/25	<b>FALTWERKZEUG</b> <ul style="list-style-type: none"> <li>• 2/3/4/5/6 mm Innensechskant</li> <li>• 1 Schlitzschraubendreher</li> <li>• 1 Kreuzschraubendreher</li> </ul>	<b>FOLDING TOOL</b> <ul style="list-style-type: none"> <li>• 2/3/4/5/6 mm allen key</li> <li>• 1 flat screwdriver</li> <li>• 1 Phillips screwdriver</li> </ul> <p>UVP 3,90 €</p>	
<b>122402</b> 500/10	<b>UNIVERSELLE NYLONTASCHE FÜR MINI-WERKZEUGE</b> <p>Zur Befestigung am Gürtel, Rucksack, Karabinerhaken, auch als Innentasche verwendbar, zur Aufbewahrung/zum Schutz von Mobiltelefonen, Werkzeug, Kleinteile, ... (ca. 120 x 73 x 35 mm)</p>	<b>UNIVERSAL NYLON BAG FOR MINI TOOLS</b> <p>For fixing at the belt, rucksack, carabiner, also usable as inner bag, for keeping/protecting mobile phones, tools, small parts, ... (approx. 120 x 73 x 35 mm)</p> <p>UVP 0,99 €</p>	

ART.-NR.	BESCHREIBUNG	DESCRIPTION	
880069	<b>ZENTRIERSTÄNDER</b> 5 • für 12"-29" Laufräder • <b>selbsttätiges Mittigstellen</b> beim Einspannen des Laufrades • simultane Kontrolle des <b>Höhen- und Seitenschlages</b> möglich • <b>Aluminium/Stahl</b> • <b>zusammenklappbar</b> • hochwertige Verarbeitung	<b>WHEEL TRUING STAND</b> • for 12"-29" wheels • clamps the wheel <b>centric</b> by <b>self-acting</b> • simultaneous control of the <b>height and side tolerances</b> possible • <b>aluminium/steel</b> • <b>foldable</b> • high-grade manufacturing	 <p style="text-align: center;">foldable</p>
			UVP 146,00 €

<b>NEW</b> 881052 1	<b>ELEKTRISCHER MONTAGE-STÄNDER</b> • <b>Stahl</b> • <b>elektrische stufenlose Höhenverstellung von 110 cm</b> • mit <b>Fernbedienung</b> • mit <b>Kunststoffablageschale</b> • max. Belastung: 50 kg • Gesamtgewicht: 110 kg • <b>variable Arbeitshöhen</b> durch Montage der Klemme an zwei möglichen Positionen: 88 - 198 cm 98 - 208 cm • 110 / 220 Volt	<b>ELECTRICAL REPAIR STAND</b> • <b>steel</b> • <b>electric stepless height adjustment of 110 cm</b> • with <b>remote control</b> • with <b>plastic tool tray</b> • max. load: 50 kg • total weight: 110 kg • <b>variable working heights</b> by mounting the clamp to two possible positions: 88 - 198 cm 98 - 208 cm • 110 / 220 Volt	 <p style="text-align: right;"><b>Bike-Lift</b></p>
	 		UVP 2999,00 €

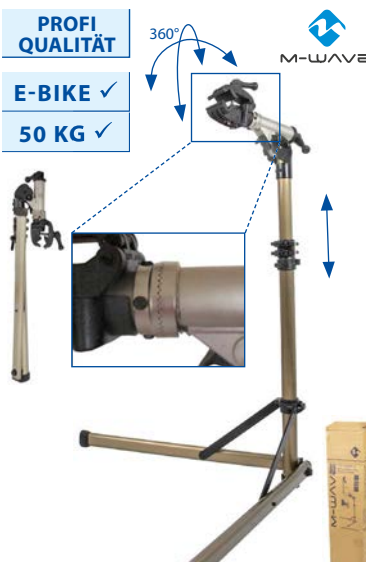
<b>NEW</b> 881054 1	<b>GALGEN MIT BELEUCHTUNG</b> • für Montageständer Art. 881052 • abnehmbare Leuchte mit <b>magnetischer Befestigung</b> • <b>1 superhelle LED</b> • im Versandkarton	<b>TOP ARM WITH LIGHT</b> • for bicycle repair stand art. 881052 • detachable lamp with <b>magnetic attachment</b> • <b>1 super bright LED</b> • in shipping box	 <p style="text-align: center;"><b>DETACHABLE LAMP WITH SUPER BRIGHT LED</b></p>
			UVP 449,00 €



ART.-NR. 	BESCHREIBUNG	DESCRIPTION	
<b>881041</b> 1	<b>MONTAGESTÄNDER &gt;TOP ASSIST 2&lt;</b> <ul style="list-style-type: none"> <li>• <b>Aluminium</b></li> <li>• mit <b>Aluminium Drehkopfverzahnung</b></li> <li>• nur 4,8 kg</li> <li>• in Sekunden zusammenleg- und aufbaubar</li> <li>• max. Belastung: <b>50 kg</b></li> <li>• <b>Klemme 360° drehbar</b></li> <li>• universell auf Rohrdurchmesser einstellbar</li> <li>• <b>höhenverstellbar</b></li> <li>• <b>stabiler</b> Stand</li> <li>• im M-Wave Einzelkarton</li> </ul>	<b>BICYCLE REPAIR STAND &gt;TOP ASSIST 2&lt;</b> <ul style="list-style-type: none"> <li>• <b>aluminium</b></li> <li>• with <b>aluminium turning head interlock</b></li> <li>• only 4.8 kg</li> <li>• foldable and defoldable in seconds</li> <li>• max. load: <b>50 kg</b></li> <li>• <b>clamp 360° turnable</b></li> <li>• universally adjustable to tube diameter</li> <li>• <b>height adjustable</b></li> <li>• <b>stable</b> stand</li> <li>• in M-Wave box</li> </ul>	 <p>UVP 334,00 €</p>
<b>881042</b> 20 set	<b>ERSATZEINSATZ FÜR KLEMME</b> <ul style="list-style-type: none"> <li>• für Montageständer Art. 881041, ...</li> <li>• 2 Klemmeinsätze mit Befestigungsclips</li> <li>• Set im Polybeutel</li> </ul>	<b>REPLACEMENT CLAMP INSERT</b> <ul style="list-style-type: none"> <li>• for assembly stand art. 881041, ...</li> <li>• 2 clamp inserts with mounting clips</li> <li>• set in PE bag</li> </ul>	 <p>UVP 9,90 €</p>
<b>881047</b> 1	<b>MONTAGE-/ REPARATURSTÄNDER</b> <ul style="list-style-type: none"> <li>• <b>faltbar</b> und <b>aufstellbar</b> in <b>Sekunden</b></li> <li>• <b>höhenverstellbar</b></li> <li>• Arbeitshöhe ca. 90 - 160 cm</li> <li>• <b>Arm 360° drehbar</b> und <b>verstellbar</b></li> <li>• mit <b>Kunststoffablageschale (Art. 880068)</b></li> <li>• mit Kratzschutz-Klemmeinsatz (Art. 881049)</li> <li>• im M-Wave Einzelkarton</li> </ul>	<b>UNIVERSAL WORKSTATION</b> <ul style="list-style-type: none"> <li>• <b>foldable</b> and <b>defoldable</b> in <b>seconds</b></li> <li>• <b>height adjustable</b></li> <li>• working height approx. 90 - 160 cm</li> <li>• <b>arm 360° turnable</b> and <b>adjustable</b></li> <li>• with <b>plastic tool tray (art. 880068)</b></li> <li>• with scratch protection clamping (art. 881049)</li> <li>• in M-Wave box</li> </ul>	 <p>UVP 121,00 €</p>
<b>881048</b> 1	<b>WAND-/WERKBANK-MONTAGE-/ REPARATURSTÄNDER &gt;TOP ASSIST W&amp;T&lt;</b> <ul style="list-style-type: none"> <li>• für <b>Wand- und Tischmontage</b></li> <li>• <b>Schnellverschluss-Klemme</b> und <b>Arm 360° drehbar</b></li> <li>• mit Kratzschutz-Klemmeinsatz (Art. 881049)</li> <li>• mit Befestigungsmaterial</li> <li>• im M-Wave Einzelkarton</li> </ul>	<b>WALL/WORKBENCH UNIVERSAL WORKSTATION &gt;TOP ASSIST W&amp;T&lt;</b> <ul style="list-style-type: none"> <li>• for <b>wall and table mounting</b></li> <li>• <b>QR clamp</b> and <b>arm 360° turnable</b></li> <li>• with scratch protection clamping (art. 881049)</li> <li>• with mounting material</li> <li>• in M-Wave box</li> </ul>	 <p>UVP 74,90 €</p>



ART.-NR.	BESCHREIBUNG	DESCRIPTION	
	<b>EDELSTAHLSCHRAUBEN</b> <ul style="list-style-type: none"> <li>mit Innensechskantkopf nach DIN 912</li> <li>50 Stück in M-Wave Kunststoffbox</li> </ul> <ul style="list-style-type: none"> <li><b>881990</b> M5 x 12 mm</li> <li><b>881991</b> M5 x 16 mm</li> </ul> 50 box	<b>STAINLESS STEEL SCREWS</b> <ul style="list-style-type: none"> <li>with allen key head acc. to DIN 912</li> <li>50 pcs in M-Wave plastic box</li> </ul> <ul style="list-style-type: none"> <li>M5 x 12 mm</li> <li>M5 x 16 mm</li> </ul>	<b>NIROSTA</b>    UVP 9,90 € / box
<b>881987</b> 500	<ul style="list-style-type: none"> <li>M3 x 8 mm</li> <li>mit Innensechskantsenkopf</li> </ul>	<ul style="list-style-type: none"> <li>M3 x 8 mm</li> <li>with allen key countersunk head</li> </ul>	 UVP 0,09 €
<ul style="list-style-type: none"> <li><b>881996</b> M5</li> <li><b>881997</b> M6</li> </ul> 50 box	<b>EDELSTAHLMUTTERN</b> <ul style="list-style-type: none"> <li><b>selbstsichernd</b> nach DIN 985</li> <li>100 Stück in M-Wave Kunststoffbox</li> </ul>	<b>STAINLESS STEEL NUTS</b> <ul style="list-style-type: none"> <li><b>self-locking</b> acc. to DIN 985</li> <li>100 pcs in M-Wave plastic box</li> </ul> <ul style="list-style-type: none"> <li>M5</li> <li>M6</li> </ul>	  UVP 11,90 € / box
<ul style="list-style-type: none"> <li><b>881989</b></li> </ul> 50 box	<b>EDELSTAHLUNTERLEGSCHLEIBEN</b> <ul style="list-style-type: none"> <li>für M5 Schrauben</li> <li>Innendurchmesser ca. 5,2/6,2 mm</li> <li>Außendurchmesser 10/12 mm</li> <li>100 Stück in M-Wave Kunststoffbox</li> </ul>	<b>STAINLESS STEEL WASHERS</b> <ul style="list-style-type: none"> <li>for M5 screws</li> <li>inner diameter approx. 5.2/6.2 mm</li> <li>outer diameter 10/12 mm</li> <li>100 pcs in M-Wave plastic box</li> </ul>	  UVP 4,90 € / box





# BUILD YOUR OWN E-BIKE

EVERYTHING FROM A SINGLE SOURCE



ALL FRAME CATEGORIES



MULTIPLE BATTERY OPTIONS



**brose**

**BAFANG**®

DRIVE TRAIN BRANDS



DISPLAY SOLUTIONS

# BUILD YOUR OWN E-BIKE

EVERYTHING FROM A SINGLE SOURCE



## YOUR BENEFIT

MANUFACTURER  
+  
*messingschlager*



MANUFACTURER  
IN-HOUSE  
DEVELOPEMENT



🕒 LESS TIME

€ LESS MONEY

👤 LESS MANPOWER

CONTACT OUR  
E-MOBILITY SOLUTIONS TEAM  
TO FIND OUT MORE ABOUT...

### OUR DIFFERENT CONCEPTS

BASED ON **brose** & **BAFANG** DRIVE TRAINS

### HOW WE CAN SUPPORT YOU

DEVELOPING THE ENTIRE BOM OF YOUR BIKE

### OUR UNIQUE FULL-SERVICE-OFFERING

CONSULTANCY, PRODUCT MANAGEMENT, SOURCING,  
LOGISTICS SERVICE & FINANCING





## UNSERE NEUEN RAHMEN - VIELFALT FÜR BROSE - ANTRIEBE OUR NEW FRAMES - VARIETY FOR BROSE - DRIVES

**brose**

[brose.messingschlager.com](http://brose.messingschlager.com)

Messingschlager und Brose verbindet eine langjährige Partnerschaft. Die Variabilität der zwei Motor-Plattformen, Alu- oder Magnesiumgehäuse, ermöglicht ein breites Einsatzspektrum. Maximale Flexibilität ist der Schlüssel zum Erfolg, was sich in den Konzepten E-MTB Fully Carbon sowie Aluminium und Gen2 (City, Trekking, Hardtail MTB) widerspiegelt. Beim neuen High-Performance-E-MTB MMC.F140.c setzen wir auf den 90 Nm starken Drive S Mag von Brose mit Magnesiumgehäuse. Bei unserer City-Plattform Gen2 kommt wahlweise ein Brose Drive C, T oder S zum Einsatz. Die unterschiedlichen Leistungsmerkmale sorgen somit für beste Anpassung an das jeweilige Marktsegment. Passend zum Motor verbauen wir konsequent Displays von Brose. Je nach Modell kommt das kompakte Remote oder das smarte Allround Display zum Einsatz. Für hohe Reichweiten montieren wir in unserem Fully den neu entwickelten Akku mit 705 Wh. Die moderne Zelltechnologie und ein hohes Maß an Leistungsdichte überzeugen auf ganzer Linie. In unserem Konzept Gen2 bieten wir wahlweise einen 522-, 630- oder 705-Wh-Akku an. Selbstverständlich ist der Akku in jedem unserer E-Bikes vollständig im Unterrohr integriert, denn nur so ist ein E-Bike wirklich sexy!

- kompatibel mit allen Brose Magnesium Antrieben
- bis zu 90 Nm Drehmoment durch den 2,9 kg leichten Brose Drive S in Magnesium möglich
- Vollintegrierte Akkulosungen mit bis zu 705 Wh Kapazität
- flexible Ausstattungsmöglichkeiten

Messingschlager and Brose have a longstanding partnership. The variability of the two motor platforms, aluminum or magnesium housing, enables a wide range of applications. Maximum flexibility is the key to success, which is reflected in the E-MTB Fully carbon and aluminium and Gen2 (City, Trekking, Hardtail MTB) concepts. For the new high-performance E-MTB MMC.F140.c we rely on the 90 Nm strong Drive S Mag from Brose with a magnesium housing. With our city platform Gen2, a Brose Drive C, T or S is optional. The different performance features ensure the best possible adaptation to the respective market. We also install Brose displays to match the engine. Depending on the model, the compact Remote or the smart Brose Allround display is used here. For long ranges, we mount the newly developed battery with 705 Wh in our Fully. State of the art cell technology and a high level of power density are used. In our concept Gen2, we offer either a 522 Wh, 630 Wh or 705 Wh battery. It goes without saying that the battery is fully integrated in the down tube of each of our e-bikes, giving a streamline and slick appearance!

- compatible with all Brose Magnesium drives
- up to 90 Nm torque thanks to the Brose Drive S, which weighs 2.9 kg in magnesium
- with fully integrated batteries from up to 705 Wh capacity
- flexible equipment options



MMC.F140.c

## BAFANG = LIGHT E-BIKE CONCEPT

**BAFANG**®

[bafang.messingschlager.com](http://bafang.messingschlager.com)

Bafang ist ein namhafter Hersteller von Antriebs-Systemen für E-Bikes jeder Gattung und nimmt weltweit eine führende Position bei Nabenmotoren ein. Zudem verfügt Bafang über eine umfangreiche Produktpalette und ermöglicht mit einer offenen Systemarchitektur größtmögliche Gestaltungsfreiheit für Fahrradhersteller. Egal ob Heck-, Mittel-, Front- oder Cargo-Motor, Bafang hat das passende Produkt im Programm. Dazu gibt es eine Vielzahl an Displays und passenden Akkus. Bei Messingschlager ist das gesamte Sortiment von Bafang erhältlich. Grund genug die Produktpalette unserer Light-E-Bikes mit ausgewählten neuen Nabenmotoren von Bafang auszustatten. Diese kompakten und leistungstarken Motoren fügen sich mit dem 360-Wh-Akku – welcher mit modernster 21700er Zelltechnologie bestückt ist – beinahe unsichtbar in das cleane Design unserer Light-E-Bikes ein. Als Display montieren wir – je nach Einsatzzweck – das sportlich-kompakte DP C11 und das übersichtliche DP C240 mit Bedieneinheit.

- Gesamtgewicht unter 15 kg möglich
- 3 verschiedene Bafang-Antriebe zur Auswahl: H 300, H 400B und H 600
- Lithium-Ionen Akku mit 360 Wh und nur 1,9 kg Gewicht durch 21700 Zelltechnologie
- verschiedene Displayoptionen

Bafang is a well-known manufacturer of motor systems for e-bikes of all types. The company occupies a leading position worldwide in hub motors, has an extensive range of products and, with its open system architecture, enables the greatest possible freedom of design for OE customers. Regardless of whether it is a rear, mid, front or cargo engine, Bafang has products to fit all markets. There are also displays of all quality levels and suitable batteries. The entire Bafang range is available from Messingschlager. This is reason enough to equip the product range of our light e-bikes with selected new hub motors of Bafang. These compact motors fit in with the 360 Wh battery - which, are equipped with the latest 21700 cell technology and fit seamlessly with the clean design of our light e-bikes. Depending on the application, we install the sporty compact DP C11 display or the clear DP C240 display with control unit.

- less than 15 kg total weight possible
- 3 different Bafang drives to choose from: H 300, H 400B and H 600
- Lithium-ion battery with 360 Wh and only 1.9 kg weight thanks to 21700 cell technology
- different display options



MRC.G.al



## MMC.HT.al

Messingschlagel Mountain Concept Hardtail Alu

„Kraftvolles E-Hardtail mit breitem Einsatzspektrum“

„Powerful e-hardtail with a wide range of uses“



## MUC.T.al

Messingschlagel Urban Concept Trekking Alu

„Mit kraftvollen 90 Nm geht's auf Entdeckungstour.“

„Go for the next discovery tour with powerful 90 Nm.“



## MUC.L.al

Messingschlagel Urban Concept Light Alu

„Stylisch & schlank, hier sieht niemand ein E-Bike!“

„Stylish & slim, nobody spots an e-bike here!“



ART.-NR.	BESCHREIBUNG	DESCRIPTION
<b>BROSE GEN 2.0 &amp; GEN 2.1</b>		
	<b>E-BIKE RAHMEN GEN 2.0</b> <ul style="list-style-type: none"> <li>• roh</li> <li>• mit außenliegendem Ladeanschluss</li> <li>• für semiintegrierten Steuersatz, 1 1/8" → 1,5", tapered (ZS 44/56)</li> <li>• für Sattelstütze mit Ø 31,6 mm</li> <li>• City/Trekking: bis 56 mm Reifenbreite</li> <li>• MTB: bis 70 mm Reifenbreite</li> </ul>	<b>E-BIKE FRAMES GEN 2.0</b> <ul style="list-style-type: none"> <li>• raw finish</li> <li>• external charging connection</li> <li>• for semi-integrated head set, 1 1/8" → 1.5", tapered (ZS 44/56)</li> <li>• for seat stays with Ø 31.6 mm</li> <li>• City/Trekking: up to 56 mm tire width</li> <li>• MTB: up to 70 mm tire width</li> </ul>
	City, 28"	City, 28"
	<b>613710</b> Größe S, 44 cm	size S, 44 cm
	<b>613711</b> Größe M, 49 cm	size M, 49 cm
	<b>613712</b> Größe L, 54 cm	size L, 54 cm
	Trekking W	Trekking W
	<b>613713</b> Größe S, 45 cm	size S, 45 cm
	<b>613714</b> Größe M, 50 cm	size M, 50 cm
	<b>613715</b> Größe L, 55 cm	size L, 55 cm
	Trekking M	Trekking M
	<b>613716</b> Größe S, 45 cm	size S, 45 cm
	<b>613717</b> Größe M, 50 cm	size M, 50 cm
	<b>613718</b> Größe L, 55 cm	size L, 55 cm
	<b>613719</b> Größe XL, 60 cm	size XL, 60 cm
MTB Hardtail, 29"	MTB Hardtail, 29"	
<b>613720</b> Größe S, 42 cm	size S, 42 cm	
<b>613721</b> Größe M, 46 cm	size M, 46 cm	
<b>613722</b> Größe L, 50 cm	size L, 50 cm	

 BROSE G2.0/G2.1



	<b>E-BIKE RAHMEN GEN 2.1</b> <ul style="list-style-type: none"> <li>• roh</li> <li>• mit außenliegendem Ladeanschluss</li> <li>• passend für IT 23 - 705 Wh Akku</li> <li>• für semiintegrierten Steuersatz, 1,5", (ZS 56/56)</li> <li>• für Sattelstütze mit Ø 31,6 mm</li> <li>• bis 62 mm Reifenbreite</li> </ul>	<b>E-BIKE FRAMES GEN 2.1</b> <ul style="list-style-type: none"> <li>• raw finish</li> <li>• external charging connection</li> <li>• suitable for IT 23 - 705 Wh battery</li> <li>• for semi-integrated head set, 1.5", (ZS 56/56)</li> <li>• for seat stays with Ø 31.6 mm</li> <li>• up to 62 mm tire width</li> </ul>
	City, 28"	City, 28"
	<b>613731</b> Größe S, 44 cm	size S, 44 cm
	<b>613732</b> Größe M, 49 cm	size M, 49 cm
	<b>613733</b> Größe L, 54 cm	size L, 54 cm
	Trekking W	Trekking W
	<b>613734</b> Größe S, 45 cm	size S, 45 cm
	<b>613735</b> Größe M, 50 cm	size M, 50 cm
	<b>613736</b> Größe L, 55 cm	size L, 55 cm
	Trekking M	Trekking M
	<b>613737</b> Größe S, 45 cm	size S, 45 cm
	<b>613738</b> Größe M, 50 cm	size M, 50 cm
	<b>613739</b> Größe L, 55 cm	size L, 55 cm
	<b>613783</b> Größe XL, 60 cm	size XL, 60 cm





ART.-NR.	BESCHREIBUNG	DESCRIPTION	
<p><b>660326</b></p> <p><b>AUSFALLENDE</b></p> <ul style="list-style-type: none"> <li>• passend für Brose G2 City-/Trekking-Rahmen</li> <li>• Postmount-Aufnahme 160 mm</li> <li>• <b>links</b></li> </ul> <p><b>AUSFALLENDE</b></p> <ul style="list-style-type: none"> <li>• passend für Brose G2 City-/Trekking-Rahmen</li> <li>• Slider <b>rechts</b> / Antriebsseite</li> </ul> <p><b>613623</b> für Nabenschaltung 20</p> <p><b>660327</b> für Kettenschaltung 20</p> <p><b>613625</b> <b>AUSFALLENDEN-SET</b> 250</p> <ul style="list-style-type: none"> <li>• passend für Brose G2 City-/Trekking-Rahmen</li> <li>• Set für 12 x 142 mm Steckachse</li> <li>• für Kettenschaltung</li> </ul>	<p><b>DERAILLEUR HANGER</b></p> <ul style="list-style-type: none"> <li>• fits Brose G2 city / trekking frames</li> <li>• for Postmount 160 mm</li> <li>• <b>left</b></li> </ul> <p><b>DERAILLEUR HANGER</b></p> <ul style="list-style-type: none"> <li>• fits Brose G2 city / trekking frames</li> <li>• slider <b>right</b> side / drive side</li> </ul> <p>for internal gear hub</p> <p>for derailleur</p> <p><b>DERAILLEUR HANGER SET</b></p> <ul style="list-style-type: none"> <li>• fits Brose G2 city / trekking frames</li> <li>• set for 12 x 142 mm thru axle</li> <li>• for derailleur</li> </ul>		
<p><b>613624</b> <b>SCHALTAUGE</b> 60</p> <ul style="list-style-type: none"> <li>• passend für Brose G2 MTB-Rahmen (Art. 613720-2)</li> <li>• rechts</li> <li>• inkl. Schrauben</li> </ul>	<p><b>DERAILLEUR HANGER</b></p> <ul style="list-style-type: none"> <li>• fits Brose G2 MTB frames (art. 613720-2)</li> <li>• right side</li> <li>• incl. screws</li> </ul>		
<p><b>STECKACHSE MIT HEBEL</b></p> <ul style="list-style-type: none"> <li>• <b>versenkbarer</b> Schnellspann-Hebel</li> <li>• <b>Aluminium</b></li> <li>• Montageverpackung</li> </ul> <p><b>321195</b> ›SCRAX B-12 148 QR‹ 200</p> <ul style="list-style-type: none"> <li>• <b>Einbaumaß 148 mm</b></li> <li>• M12 x Länge 178 mm</li> <li>• nur 55 g</li> <li>• Gewindesteigung 1,5 mm</li> <li>• Gewindelänge 18 mm</li> <li>• z.B. für MTB- oder E-Bike-Rahmen</li> </ul>	<p><b>THRU AXLE WITH LEVER</b></p> <ul style="list-style-type: none"> <li>• <b>hidden</b> QR lever</li> <li>• <b>aluminium</b></li> <li>• OEM</li> </ul> <p>›SCRAX B-12 148 QR‹</p> <ul style="list-style-type: none"> <li>• <b>OLD 148 mm</b></li> <li>• M12 x length 178 mm</li> <li>• only 55 g</li> <li>• thread pitch: 1.5 mm</li> <li>• thread length: 18 mm</li> <li>• e. g. for MTB or e-bike frames</li> </ul>		<p><b>BOOST</b> OLD 148</p> <p>M-WAVE</p> <p><b>BROSE G1 G2.0</b></p>
<p><b>321138</b> ›SCRAX B-12 142 QR‹ 200</p> <ul style="list-style-type: none"> <li>• <b>Einbaumaß 142 mm</b></li> <li>• M12 x Länge 157 mm</li> <li>• nur 53 g</li> <li>• Gewindesteigung 1,5 mm</li> <li>• Gewindelänge 10 mm</li> <li>• z. B. für Gravel-Rahmen Art. 666141-5</li> </ul>	<p>›SCRAX B-12 142 QR‹</p> <ul style="list-style-type: none"> <li>• <b>OLD 142 mm</b></li> <li>• M12 x length 157 mm</li> <li>• only 53 g</li> <li>• thread pitch: 1.5 mm</li> <li>• thread length: 10 mm</li> <li>• e. g. for gravel frames art. 666141-5</li> </ul>		<p><b>BROSE G2.0 G2.1</b></p>

**NEW**













ART.-NR.	BESCHREIBUNG	DESCRIPTION	
	<b>BROSE MOTOREN UND ZUBEHÖR</b>	<b>BROSE MOTORS AND ACCESSORIES</b>	
<b>613020</b>	Drive C Mag (horizontal), 50 Nm	Drive C Mag (horizontal), 50 Nm	
<b>613019</b>	Drive T Mag (horizontal), 70 Nm	Drive T Mag (horizontal), 70 Nm	
<b>613016</b>	Drive S Mag (horizontal), 90 Nm	Drive S Mag (horizontal), 90 Nm	
<b>613021</b>	Drive TF Mag (horizontal), 70 Nm, 45 km/h	Drive TF Mag (horizontal), 70 Nm, 45 km/h	
<b>613029</b>	Drive H Mag (horizontal), 90 Nm, für z.B. Cargo-Bikes bis zu 250 kg	Drive H Mag (horizontal), 90 Nm, for e.g. cargo bikes up to 250 kg	
<b>NEW</b> 120			
<b>613403</b>	Designcover Brose Drive Mag • rechte und linke Seite • inkl. Schrauben	design cover Brose Drive Mag • right and left side • incl. screws	
<b>613405</b>	Designcover für MTB Fully • rechte und linke Seite • inkl. zwei schwarze Schrauben A2	design cover for MTB Fully • right and left side • incl. two black screws A2	
60			
	<b>DISPLAY UND ZUBEHÖR</b>	<b>DISPLAY AND ACCESSORIES</b>	
<b>613056</b>	LCD Farbdisplay ›Allround‹	LCD colour display ›Allround‹	
120			
<b>613058</b>	Bedieneinheit ›Remote‹ mit LED-Anzeige	operating unit ›Remote‹ with LED display	
120			
<b>613060</b>	Display ›City‹ optionale Ergänzung zu Bedieneinheit ›Remote‹ (Art. 613058)	Display ›City‹ optional supplement to control unit ›Remote‹ (art. 613058)	
40			
<b>613044</b>	Y-Kabel Verbindung zwischen Art. 613060 und Art. 613058	Y-cable connection between art. 613060 and art. 613058	
60			
	<b>ZUBEHÖR UND MONTAGETEILE</b>	<b>ACCESSORIES AND MOUNTING PARTS</b>	
<b>613078</b>	Kabelbaum BN21L	harness BN21L	
60			
<b>613075</b>	Kabelbaum IT23	harness IT23	
<b>NEW</b> 60			
<b>613061</b>	Kabelsatz zwischen Motor und Display, internal wake up, 1.300 mm	Connector between motor and display, internal wake up, 1,300 mm	
120			
<b>613083</b>	Montage Kit Brose Mag horizontal 3 Muttern, 1 Unterlegscheibe, 1 Schraube	Montage Kit Brose Mag horizontal 3 nuts, 1 washer, 1 screw	
120			
<b>613045</b>	Gear Sensor, Mag-Serie	Gear Sensor, Mag-series	
300			
<b>613092</b>	Geschwindigkeitssensor	speed sensor	
120			
<b>613091</b>	Speichenmagnet	spoke magnet	
120			
<b>613097</b>	Ringmutter zur Montage des Spiders	ring nut for spider	
120			



ART.-NR. 	BESCHREIBUNG	DESCRIPTION	
<b>613090</b> 120	<b>LICHTKABEL</b> für Frontbeleuchtung, 1.095 mm	<b>LIGHT CABLES</b> for head light, 1,095 mm	  
<b>613080</b> 120	Kabel für Rücklicht und Bremslicht Brose Drive Mag, 1.400 mm	cable for rear light and brake light Brose Drive Mag, 1,400 mm	
<b>613099</b> 120	<b>BLINDSTOPFEN AM MOTOR</b> für Lichtanschlüsse	<b>COVERPLUGS FOR MOTOR</b> for lighting connector	 
<b>613086</b> 120	für Gangsensor	for gear sensor	

## BROSE GEN 1 ALU

## BROSE GEN 1 ALU



<b>613660</b> <b>613606</b> <b>613607</b> <b>613608</b> 4	<b>E-BIKE RAHMEN ›TREKKING W‹</b> <ul style="list-style-type: none"> <li>• roh</li> <li>• mit außenliegendem Ladeanschluss</li> <li>• für semiintegrierten Steuersatz, 1 1/8" → 1,5"</li> <li>• für Sattelstütze mit Ø 31,6 mm</li> </ul> Trekking M Größe S, 45 cm Größe M, 50 cm Größe L, 55 cm Größe XL, 60 cm	<b>E-BIKE FRAMES ›TREKKING W‹</b> <ul style="list-style-type: none"> <li>• raw finish</li> <li>• external charging connection</li> <li>• for semi-integrated head set, 1 1/8" → 1.5"</li> <li>• for seat stays with Ø 31.6 mm</li> </ul> Trekking M size S, 45 cm size M, 50 cm size L, 55 cm size XL, 60 cm	 
<b>613609</b> 300 <b>613610</b> 250	<b>AUSFALLENDEN</b> für City Wave, Trekking und MTB-Rahmen <b>613609</b> für Schaltwerk, für Antriebsseite <b>613610</b> für Nabenschaltung, für Antriebsseite	<b>DERAILLEUR HANGER</b> for City Wave, Trekking and MTB frames <b>613609</b> for rear derailleur, for drive side <b>613610</b> for internal gear hub, for drive side	
<b>613614</b> 200	<b>613614</b> für Nicht-Antriebsseite, mit Befestigung für Postmount Bremse 160 mm	<b>613614</b> for non-drive side, with brake mount PM 160 mm	  
<b>613800</b> 200	<b>613800</b> Typ "MTB", für Steckachse 12 mm, Aluminium, silber eloxiert	<b>613800</b> "MTB" type, for thru axle 12 mm, aluminium, silver anodised	
<b>613801</b> 200	<b>613801</b> Gewindeinsatz für Schalttauge Typ "MTB" (Art. 613800), Aluminium, schwarz	<b>613801</b> thread insert for derailleur hanger "MTB" type (art. 613800), aluminium, black	
<b>613200</b> <b>613810</b> 100	<b>AKKU UND AKKUZUBEHÖR</b> <b>613200</b> Linkage-Akku, 504 Wh <b>613810</b> Schloss mit 2 Schlüsseln	<b>BATTERY AND ACCESSORIES</b> <b>613200</b> linkage battery, 504 Wh <b>613810</b> lock with 2 keys	 
<b>613093</b> 60 <b>881987</b> 500	<b>613093</b> Kabelbaum für Linkage-Akku <b>881987</b> Befestigungsschraube für Kabelbaum (Art. 613093), Edelstahl, M3 x 8 mm (pro Kabelbaum werden 8 Schrauben benötigt)	<b>613093</b> cable harness for linkage battery <b>881987</b> screw for cable harness (art. 613093), stainless steel, M3 x 8 mm (per cable harness 8 screws are needed)	
<b>613230</b> 20 <b>613231</b> 20	<b>613230</b> Ladegerät 2A, Ladezeit 7 Std. <b>613231</b> Schnellladegerät 4A, Ladezeit 3,5 Std.	<b>613230</b> travel charger 2A, charging time 7 hours <b>613231</b> speed charger 4A, charging time 3.5 hours	







ART.-NR.	BESCHREIBUNG	DESCRIPTION	
<b>613015</b>	<b>BROSE MOTOREN UND ZUBEHÖR</b> Drive C, 50 Nm	<b>BROSE MOTORS AND ACCESSORIES</b> Drive C, 50 Nm	
<b>613018</b>	Drive T, 70 Nm	Drive T, 70 Nm	
<b>613010</b>	Drive S, 90 Nm	Drive S, 90 Nm	
<b>613012</b> 120	Drive TF (S-Pedelec, 45 km/h), 90 Nm	Drive TF (S-Pedelec, 45 km/h), 90 Nm	
	<b>Motorabdeckung</b>	<b>motor cover</b>	
<b>613400</b>	Designcover, rechte Seite, inkl. Schrauben	design cover, right side, incl. screws	
<b>613401</b>	Designcover, linke Seite, inkl. Schrauben	design cover, left side, incl. screws	
<b>613402</b> 60	Brose Logo Button	Brose Logo button	
	<b>ZUBEHÖR UND MONTAGETEILE</b>	<b>ACCESSORIES AND MOUNTING PARTS</b>	
	<b>notwendig</b>	<b>essential</b>	
<b>613055</b>	Kabelsatz zwischen Motor und Display	display cable (connection to the motor)	
<b>613096</b> 120	Motor Montage-Muttern (Set 3 Stück), M8	motor mounting bolts (set 3 pcs), M8	
<b>613085</b> 100	<b>optional empfohlen</b> Gangsensor für Nabenschaltung	<b>optional advice</b> gearsensor for internal gearhubs	
	<b>LICHTKABEL</b>	<b>LIGHT CABLES</b>	
<b>613087</b> 120	für Rückbeleuchtung, 1.323 mm, Brose Drive Alu	for rear light, 1,323 mm, Brose Drive Alu	

## MTB CARBON FULLY BROSE GF

 <b>NEW</b>	<b>E-BIKE RAHMEN</b> ›MTB CARBON FULLY‹	<b>E-BIKE FRAMES</b> ›MTB CARBON FULLY‹		
	<ul style="list-style-type: none"> <li>• Vollcarbon-Rahmen</li> <li>• mit außenliegendem Ladeanschluss</li> <li>• 27,5", 29" oder Mixed-Wheels-Setup möglich</li> <li>• All Mountain/Trail (140 mm) oder SUV (130 mm)</li> <li>• für semiintegrierten Steuersatz, 1 1/8" → 1,5"</li> <li>• durchgehende kurze Sitzrohre für max. Dropper-Hub</li> <li>• Kettenführung am Rahmen verschraubt</li> <li>• Disc Postmount Aufnahme</li> <li>• passend für Brose IT23, 705 Wh Akku</li> </ul>	<ul style="list-style-type: none"> <li>• full carbon frame</li> <li>• external charging connection</li> <li>• 27.5", 29" or Mixed-Wheels-Setup possible</li> <li>• All Mountain/Trail (140 mm) or SUV (130 mm)</li> <li>• for semi-integrated head set, 1 1/8" → 1.5"</li> <li>• continuous short seat tubes for max. dropper hub</li> <li>• chain guide screwed to the frame</li> <li>• disc postmount</li> <li>• suitable for Brose IT23, 705 Wh battery</li> </ul>		
	<b>666250</b>	Größe S/M, 40 cm		size S/M, 40 cm
	<b>666251</b>	Größe M/L, 42 cm		size M/L, 42 cm
<b>666252</b> 2	Größe L/XL, 48 cm	size L/XL, 50 cm		
<b>660089</b> 50	<b>AUSFALLENDE</b> ›Universal Derailleur Hanger‹	<b>DERAILLEUR HANGER</b> ›Universal Derailleur Hanger‹		
<b>613408</b> 350	<b>SCHUTZBLECHWINKEL</b>	<b>FENDER MOUNTING BRIDGE</b>		
<b>303362</b> 100	<b>KETTENFÜHRUNG</b>	<b>CHAIN GUIDE</b>		

ART.-NR.	BESCHREIBUNG	DESCRIPTION	
	<b>ZUBEHÖR UND MONTAGETEILE</b>	<b>ACCESSORIES AND MOUNTING PARTS</b>	
<b>666101</b>	Kabelführung, einfach	Cable guide, single hole	
<b>666102</b>	Kabelführung, doppelt	Cable guide, double hole	
<b>666104</b>	Kabelführung, doppelt, ein Loch und eine Kabelführung (für Brose Displaykabel), links	Cable guide, double, one hole and one cable guide (for Brose display cable), left side	
<b>666114</b> 500	Kabelführung, doppelt, ein Loch und eine Kabelführung (für Brose Displaykabel), rechts	Cable guide, double, one hole and one cable guide (for Brose display cable), right side	
<b>610006</b> 500	<b>KETTENSTREBENSCHUTZ FÜR E-FULLY</b> <ul style="list-style-type: none"> <li>Material: <b>Silikonkautschuk</b></li> <li>Größe: ca. <b>316 x 52 x 47 mm</b></li> <li>Montageverpackung</li> </ul>	<b>CHAINSTAY PROTECTION FOR E-FULLY</b> <ul style="list-style-type: none"> <li>material: <b>silicone rubber</b></li> <li>size: approx. <b>316 x 52 x 47 mm</b></li> <li>OEM</li> </ul>	
	<b>STECKACHSE</b> <ul style="list-style-type: none"> <li>Einbaumaß <b>148 mm</b></li> <li>Innensechskant Fixierung</li> <li>Gewindesteigung 1,0 mm</li> <li>Gewindelänge 12,7 mm</li> <li>mit Innengewinde M5 x P0,8 auf beiden Seiten</li> <li>Montageverpackung</li> </ul>	<b>THRU AXLE</b> <ul style="list-style-type: none"> <li><b>OLD 148 mm</b></li> <li><b>allen screw fixation</b></li> <li>thread pitch: 1.0 mm</li> <li>thread length: 12.7 mm</li> <li>with inner thread M5 x P0.8 on both sides</li> <li>OEM</li> </ul>	
<b>321130</b>	M12 x Länge <b>186 mm</b> Flat-Achse	M12 x length <b>186 mm</b> flat axle	
<b>321131</b> 200	M12 x Länge <b>170 mm</b> Cone-Achse	M12 x length <b>170 mm</b> cone axle	
<b>613409</b> 150	Adapter für Parkstützen	Kickstand Adapter	
<b>ALU ENDURO</b>		<b>ALU ENDURO</b>	
<b>NEW</b>	<b>E-BIKE RAHMEN</b> <ul style="list-style-type: none"> <li>Aluminium</li> <li>roh</li> </ul>	<b>E-BIKE FRAMES</b> <ul style="list-style-type: none"> <li>aluminium</li> <li>raw finish</li> </ul>	
<b>666180</b>	Größe S/M, 40 cm	size S/M, 40 cm	
<b>666181</b>	Größe M/L, 42 cm	size M/L, 42 cm	
<b>666182</b> 2	Größe L/XL, 48 cm	size L/XL, 50 cm	
<b>660089</b> 50	<b>AUSFALLENDE</b> ›Universal Derailleur Hanger‹	<b>DERAILLEUR HANGER</b> ›Universal Derailleur Hanger‹	



ART.-NR. 	BESCHREIBUNG	DESCRIPTION	
<b>303361</b> <b>NEW</b> 100	<b>KETTENFÜHRUNG</b> <ul style="list-style-type: none"> <li>• für E-Enduro Fully</li> <li>• 28 - 34 Zähne</li> <li>• direkte Rahmenbefestigung</li> </ul>	<b>CHAIN GUIDE</b> <ul style="list-style-type: none"> <li>• for E-Enduro Fully</li> <li>• 28 - 34 teeth</li> <li>• direct frame mounting</li> </ul>	 
<b>610006</b> 500	<b>KETTENSTREBENSCHUTZ FÜR E-FULLY</b> <ul style="list-style-type: none"> <li>• Material: <b>Silikonkautschuk</b></li> <li>• Größe: ca. <b>316 x 52 x 47 mm</b></li> <li>• Montageverpackung</li> </ul>	<b>CHAINSTAY PROTECTION FOR E-FULLY</b> <ul style="list-style-type: none"> <li>• material: <b>silicone rubber</b></li> <li>• size: approx. <b>316 x 52 x 47 mm</b></li> <li>• OEM</li> </ul>	 
<b>321137</b> <b>NEW</b> 100	<b>STECKACHSE</b> <ul style="list-style-type: none"> <li>• <b>Einbaumaß 148 mm</b></li> <li>• mit Schnellspanner</li> <li>• Aluminium</li> <li>• Boost Standard</li> <li>• M12 x Länge <b>173 mm</b></li> <li>• Gewindesteigung 1,0 mm</li> <li>• Gewindelänge 14 mm</li> <li>• für Rahmen Art. 661250-3</li> <li>• Montageverpackung</li> </ul>	<b>THRU AXLE</b> <ul style="list-style-type: none"> <li>• <b>OLD 148 mm</b></li> <li>• with QR</li> <li>• aluminium</li> <li>• boost standard</li> <li>• M12 x length <b>173 mm</b></li> <li>• thread pitch: 1.0 mm</li> <li>• thread length: 14 mm</li> <li>• for frames art. 661250-3</li> <li>• OEM</li> </ul>	
<b>AKKU UND AKKUZUBEHÖR</b>  <b>613215</b> <b>NEW</b> 4  <b>613218</b> <b>NEW</b> 20  <b>613217</b> <b>NEW</b>  <b>613222</b> <b>NEW</b>  <b>613242</b> <b>NEW</b>  <b>613219</b> <b>NEW</b>  <b>613216</b> <b>NEW</b> 10	<b>E-Bike Akku BMZ Brose V10 36 V Intube, 725 Wh</b>  Cover-Set <ul style="list-style-type: none"> <li>• Aluminium</li> <li>• schwarz</li> </ul> Montage-Set  Akkuschluss mit zwei Schlüsseln  Ladebuchse externer Anschluss im Rahmen  Service Box Brose BMZ RS TQ  Schnellladegerät, 4A Brose BMZ 8pol-Plug	<b>BATTERY AND ACCESSORIES</b>  e-bike battery BMZ Brose V10 36 V Intube, 725 Wh  cover set <ul style="list-style-type: none"> <li>• aluminium</li> <li>• black</li> </ul> mounting set  battery lock with two keys  charging socket external connection in the frame  service box Brose BMZ RS TQ  quick charger, 4A Brose BMZ 8pol-Plug	  

ART.-NR.	BESCHREIBUNG	DESCRIPTION	
<b>SERVICE TEILE BROSE</b>		<b>SERVICE PARTS BROSE</b>	
<b>610056</b>	<b>AKKU UND AKKUZUBEHÖR</b> E-Bike Akku, 630 Wh	<b>BATTERY AND ACCESSORIES</b> e-bike battery, 630 Wh	 
<b>610005</b>	Subframe inkl. Schloss und Kabelbaum für Akku Art. 610056	subframe incl. lock and wiring harness for battery art. 610056	
<b>881984</b>	Befestigungsschraube M6x1.0x10 mm für Brose Subframe Art. 610005	fixing screw M6x1.0x10 mm for Brose sub-frame art. 610005	
<b>613082</b>	Ladebuchse, externer Anschluss im Rahmen	charging socket, external port in frame	
<b>613234</b>	Schnellladegerät, 4A	quick charger, 4A	
<b>613235</b>	Netzkabel für Schnellladegerät Art. 613234, <b>EU</b> -Stecker	power cable for quick charger art. 613234, <b>EU</b> plug	
<b>613239</b>	Netzkabel für Schnellladegerät Art. 613234, <b>UK</b> -Stecker	power cable for quick charger art. 613234, <b>UK</b> plug	
<b>613298</b>	Diagnosetool für Linkage-Akku (Art. 613200)	diagnostic tool for linkage battery (art. 613200)	
<b>613299</b>	Verbindungskabel von Diagnosetool (Art. 613298) zum Akku	connecting cable from diagnostic tool (art. 613298) to the battery	
<b>613084</b>	E-Bike Service-Adapter zur Verbindung des Brose E-Bike Systems mit dem PC (zwischen Motor und Display)	e-bike service adapter for connection of the Brose e-bike system with the PC (between motor and display)	 
<b>613047</b>	Belt Service Kit für Drive Alu	belt service kit for Drive Alu	
<b>613048</b>	Belt Service Kit für Drive Mag	belt service kit for Drive Mag	
<b>613204</b>	Li-Ion Akku • DT external bottle type • universell für Brose verwendbar • baugleich mit BMZ • 36 Volt, 11 Ah, 396 Wh	Li-Ion battery • DT external bottle type • universally suitable for Brose • identical to BMZ • 36 Volt, 11 Ah, 396 Wh	 
<b>613203</b>	Li-Ion Akku • DT external bottle type • universell für Brose verwendbar • baugleich mit BMZ • 36 Volt, 17,5 Ah, 630 Wh	Li-Ion battery • DT external bottle type • universally suitable for Brose • identical to BMZ • 36 Volt, 17,5 Ah, 630 Wh	
<b>613238</b>	Montagekit, Zubehörsatz für Li-Ion Akku Art. 613203/4	mounting kit, accessory kit for Li-Ion battery art. 613203/4	

ART.-NR.	BESCHREIBUNG	DESCRIPTION	
<b>LIGHT GEN 1</b>		<b>LIGHT GEN 1</b> 	
	<p><b>E-BIKE RAHMEN ›URBAN LIGHT‹</b></p> <ul style="list-style-type: none"> <li>• roh</li> <li>• für semiintegrierten Steuersatz, 1 1/8"</li> <li>• für Sattelstütze mit Ø 31,6 mm</li> </ul> <p>City Wave</p> <p><b>660374</b> Größe S, 46 cm  <b>660375</b> Größe M, 52 cm  <b>660376</b> Größe L, 58 cm</p> <p>Urban/City/Gravel</p> <p><b>660370</b> Größe S, 46 cm  <b>660371</b> Größe M, 50 cm  <b>660372</b> Größe L, 54 cm  <b>660373</b> Größe XL, 58 cm</p> <p>2</p>	<p><b>E-BIKE FRAMES ›URBAN LIGHT‹</b></p> <ul style="list-style-type: none"> <li>• raw finish</li> <li>• for semi-integrated head set, 1 1/8"</li> <li>• for seat stays with Ø 31.6 mm</li> </ul> <p>City Wave</p> <p>size S, 46 cm  size M, 52 cm  size L, 58 cm</p> <p>Urban/City/Gravel</p> <p>size S, 46 cm  size M, 50 cm  size L, 54 cm  size XL, 58 cm</p>	
<b>AKKU UND AKKUZUBEHÖR</b>		<b>BATTERY AND ACCESSORIES</b>	
<b>613293</b>	Akku für "Urban Light", 36 V, 360 Wh	battery for "Urban Light", 36 V, 360 Wh	 
<b>613295</b>	Ladegerät, 2 A, EU	charger, 2 A, EU	
<b>613292</b>	Ladegerät, 2 A, UK	charger, 2 A, UK	
<b>SERVICE TEILE</b>		<b>SERVICE PARTS</b>	
<b>613294</b>	Kabelsatz für Akku	battery connector	
<b>613627</b>	Unterrohr Abdeckung passend für Rahmen Art. 660374/5/6	downtube cover suitable for frames art. 660374/5/6	
<b>660321</b>	Unterrohr Abdeckung passend für Rahmen Art. 660370/1/2/3	downtube cover suitable for frames art. 660370/1/2/3	
<b>613296</b>	Ladebuchse	charger socket	
<b>613297</b>	Ein/Aus Knopf	on/off button	
<b>610521</b>	Service-Adapter	service adapter	

ART.-NR.

BESCHREIBUNG

DESCRIPTION



**LIGHT GEN 2**

**LIGHT GEN 2**



**NEW**

**E-BIKE RAHMEN  
›URBAN LIGHT 2.0‹**

- roh
- für semiintegrierten Steuersatz, 1,5" - ZS 56/56
- für Sattelstütze mit Ø 31,6 mm
- werkzeuglos entnehmbarer Akku nach unten

City Wave

**666171** Größe S, 46 cm

**666172** Größe M, 52 cm

**666173** Größe L, 58 cm

Trekking - Gent

**666176** Größe S, 46 cm

**666177** Größe M, 50 cm

**666178** Größe L, 54 cm

**666179** Größe XL, 58 cm

Gravel

**666150** Größe XS, 44 cm

**666151** Größe S, 48 cm

**666152** Größe M, 52 cm

**666153** Größe L, 56 cm

**666154** Größe XL, 60 cm

2

**E-BIKE FRAMES  
›URBAN LIGHT 2.0‹**

- raw finish
- for semi-integrated head set, 1.5" - ZS 56/56
- for seat stays with Ø 31.6 mm
- toollessly removable battery at the bottom

City Wave

size S, 46 cm

size M, 52 cm

size L, 58 cm

Trekking - Gent

size S, 46 cm

size M, 50 cm

size L, 54 cm

size XL, 58 cm

Gravel

size XS, 44 cm

size S, 48 cm

size M, 52 cm

size L, 56 cm

size XL, 60 cm



**NEW**

**E-BIKE JUGENDRAHMEN**

- Aluminium
- roh
- für semi integrierten Steuersatz, ZS 44/44
- werkzeuglos entnehmbarer Akku

**666200** ›YOUTH 24‹

- 24" Räder
- 32 cm

**666210** ›YOUTH 26‹

2

- 26" Räder
- 35 cm

**E-BIKE JUNIOR FRAMES**

- aluminium
- raw finish
- for semi-integrated head set, ZS 44/44
- toollessly removable battery

›YOUTH 24‹











- 24" tires
- 32 cm

›YOUTH 26‹

- 26" tires
- 35 cm





ART.-NR.	BESCHREIBUNG	DESCRIPTION	
<p><b>613220</b></p> <p><b>NEW</b></p>	<p><b>AKKU UND AKKUZUBEHÖR</b></p> <p>E-Bike Akku IT21</p> <ul style="list-style-type: none"> <li>• integriert</li> <li>• 36 V</li> <li>• 360 Wh</li> </ul>	<p><b>BATTERY AND ACCESSORIES</b></p> <p>e-bike battery IT21</p> <ul style="list-style-type: none"> <li>• integrated</li> <li>• 36 V</li> <li>• 360 Wh</li> </ul>	<p>GRS Batterien Service GmbH</p> <p>BAFANG GL 2.0</p> 
<p><b>613227</b></p> <p><b>NEW</b></p>	<p>Ladegerät, 4 A, EU-Typ</p>	<p>charger, 4 A, EU type</p>	
<p><b>613240</b></p> <p><b>NEW</b></p>	<p>Montage Set IT21 mit Akku-Kabel Jugend</p>	<p>mounting-set IT21 with battery cable youth</p>	
<p><b>613241</b></p> <p><b>NEW</b></p>	<p>Montage Set IT21 mit Akku-Schloss Jugend</p>	<p>mounting-set IT21 with battery lock youth</p>	
<p><b>613252</b></p> <p><b>NEW</b></p>	<p>Montage Set IT21 mit Akku-Kabel GL 2.0</p>	<p>mounting-set IT21 with battery cable GL 2.0</p>	 <p>Art. 613240/52</p>
<p><b>613253</b></p> <p><b>NEW</b></p>	<p>Montage Set IT21 mit Akku-Schloss GL 2.0</p>	<p>mounting-set IT21 with battery lock GL 2.0</p>	 <p>Art. 613241/53</p>
	<p><b>BAFANG MOTOREN UND ZUBEHÖR</b></p>	<p><b>BAFANG MOTORS AND ACCESSORIES</b></p>	<p>BAFANG GL 2.0</p>
<p><b>610532</b></p> <p>6</p>	<p><b>Motor H300</b></p> <p>Einbaumaß: 145 mm</p> <p>36 V / 250 W</p> <p>Gewicht: 3 kg</p> <p>Drehmoment: 32 Nm</p> <p>Größe/Durchmesser: 136 mm</p> <p>Zahnkranzaufnahme: Schraubkranz</p> <p>Kabellänge: 250 mm</p>	<p><b>Motor H300</b></p> <p>OLD: 145 mm</p> <p>36 V / 250 W</p> <p>weight: 3 kg</p> <p>torque: 32 Nm</p> <p>size/diameter: 136 mm</p> <p>sprocket holder: screw ring</p> <p>cable length: 250 mm</p>	
<p><b>610530</b></p> <p>4</p>	<p><b>Motor H400B</b></p> <p>Einbaumaß: 145 mm</p> <p>36 V / 250 W</p> <p>Gewicht: ca. 3,3 kg</p> <p>Drehmoment: 45 Nm</p> <p>Größe/Durchmesser: 158,5 mm</p> <p>Zahnkranzaufnahme: Kassettenzahnkranz</p> <p>Kabellänge: 250 mm</p>	<p><b>Motor H400B</b></p> <p>OLD: 145 mm</p> <p>36 V / 250 W</p> <p>weight: ca. 3.3 kg</p> <p>torque: 45 Nm</p> <p>size/diameter: 158.5 mm</p> <p>sprocket holder: cassette sprocket</p> <p>cable length: 250 mm</p>	
<p><b>610531</b></p> <p>6</p>	<p><b>Motor H600</b></p> <p>Einbaumaß: 146,25 mm</p> <p>36 V / 250 W</p> <p>Gewicht: 2 kg</p> <p>Drehmoment: 42 Nm</p> <p>Größe/Durchmesser: 105 mm</p> <p>Zahnkranzaufnahme: Kassettenzahnkranz</p> <p>Kabellänge: 250 mm</p>	<p><b>Motor H600</b></p> <p>OLD: 146.25 mm</p> <p>36 V / 250 W</p> <p>weight: 2 kg</p> <p>torque: 42 Nm</p> <p>size/diameter: 105 mm</p> <p>sprocket holder: cassette sprocket</p> <p>cable length: 250 mm</p>	
<p><b>610540</b></p> <p><b>NEW</b></p>	<p><b>Heckmotor H700</b></p> <ul style="list-style-type: none"> <li>• Einbaumaß: 145 mm</li> <li>• 36 V / 250 W</li> <li>• Gewicht: 4,1 kg</li> <li>• Drehmoment: 45-55 Nm</li> <li>• Größe/Durchmesser: 145 mm</li> <li>• dual speed drive</li> </ul>	<p><b>Rear motor H700</b></p> <ul style="list-style-type: none"> <li>• OLD: 145 mm</li> <li>• 36 V / 250 W</li> <li>• weight: 4.1 kg</li> <li>• torque: 45-55 Nm</li> <li>• size/diameter: 145 mm</li> <li>• dual speed drive</li> </ul>	

ART.-NR.	BESCHREIBUNG	DESCRIPTION	
	<b>DISPLAY UND ZUBEHÖR</b>	<b>DISPLAY AND ACCESSORIES</b>	
<b>610524</b> <b>NEW</b> 60	LCD Display DP C191 CAN • 36 V • Bluetooth	LCD Display DP C191 CAN • 36 V • bluetooth	
<b>610526</b> <b>NEW</b> 30	LCD Display DP C221 CAN Bus • 36 V • Bluetooth • Lenkerklemme Ø 22,2 mm • Kabellänge 230 mm	LCD Display DP C221 CAN Bus • 36 V • bluetooth • bar clamp Ø 22.2 mm • cable length 230 mm	
<b>610514</b> 60	LCD Display C240 CAN Bus	LCD Display C240 CAN Bus	
<b>610525</b> <b>NEW</b> 60	LCD Display C263 CAN Bus • Bluetooth • Grau • speziell für Gravel/Rennrad	LCD Display C263 CAN Bus • bluetooth • grey • especially for Gravel/Road	
<b>610523</b> 120	LED Display E161 CAN Bus • Bluetooth	LED Display E161 CAN Bus • bluetooth	
<b>610516</b> 100	Verbindungskabel Display Controller, 1,200 mm	connecting cable display controller, 1,200 mm	
	<b>ZUBEHÖR UND MONTAGETEILE</b>	<b>ACCESSORIES AND MOUNTING PARTS</b>	
<b>610515</b> 48	Steuergerät	Controller	
<b>610502</b> 20	Tretlager mit Drehmoment-Sensor	bottom bracket with torque sensor	
<b>610519</b> 50	Innenlager mit Geschwindigkeitssensor, 126 mm Achse	bottom bracket with Speedsensor, 126 mm axle	
<b>610533</b> 100	Spider (für Tretlager mit Drehmoment- und Tretsensor Art. 610502), Lochkreis: 104 mm	spider (for bottom bracket with torque sensor art. 610502), BCD: 104 mm	
<b>352602</b> 50	Kurbelarm links, Aluminium, 170 mm (für Tretlager Art. 610502)	crank left, aluminium, 170 mm (for bottom bracket art. 610502)	
<b>352603</b> 50	Kurbelarm rechts, Aluminium, 170 mm (für Tretlager Art. 610502)	crank right, aluminium, 170 mm (for bottom bracket art. 610502)	
<b>NEW</b>	<b>KURBEL ›EC33‹</b> • rechts & links • Aluminium • 0 mm Offset • JIS • schwarz • Montageverpackung	<b>CRANK ›EC33‹</b> • right & left • aluminium • 0 mm Offset • JIS • black • OEM	
<b>352456</b>	150 mm	150 mm	
<b>352457</b> 50	160 mm	160 mm	
	<b>LICHTKABEL</b>	<b>LIGHT CABLES</b>	
<b>610517</b>	für Frontbeleuchtung, 1,200 mm	for head light, 1,200 mm	
<b>610518</b>	für Rückbeleuchtung, 1,200 mm	for rear light, 1,200 mm	

**SRAM**

**ROCK SHOX**

**Sram** und **RockShox** – das sind die führenden internationalen Marken für Antriebe, Schaltwerke, Federgabeln und Dämpfer im MTB, Road und Gravel Bereich. Vielseitige Lösungen bedienen auf höchstem technischen Niveau die gestellten Anforderungen des jeweiligen Fahrrad-Konzepts. Als OEM können Sie ab sofort **das gesamte Teilesortiment der Marken Sram und RockShox** über Messingschlager beziehen.

Sram and RockShox - these are the leading international brands for drives, derailleurs, suspension forks and suspensions in the MTB, road and gravel sector. Versatile solutions meet the requirements of the respective bicycle concept at the highest technical level. As an OEM, you can now obtain the entire range of parts from the brands Sram and RockShox via Messingschlager.

In der Entwicklung unseres brandneuen Allmountain E-MTB Fully aus Carbon wurde die Fahrwerksabstimmung bereits in enger Zusammenarbeit mit den Ingenieuren aus Schweinfurt durchgeführt. Diese Teile finden Sie exemplarisch auf den folgenden beiden Seiten aufgeführt. Sprechen Sie uns auf weitere gewünschte Teile an – wir helfen Ihnen gern bei der Auswahl!

During the development of our brand new allmountain E-MTB fully made of carbon, the chassis tuning was already carried out in close cooperation with the engineers from Schweinfurt. These parts can be found as examples on the following two pages. Feel free to contact us regarding other desired parts - we will gladly help you choose!











ART.-NR.	BESCHREIBUNG	DESCRIPTION	
<p><b>390054</b></p> <p><b>NEW</b> 10</p>	<p><b>FEDERGABEL</b>                      ›ZEB SELECT CHARGER RC 29"‹</p> <ul style="list-style-type: none"> <li>• Federweg: 170 mm</li> <li>• Federsystem: DebonAir+ Luftfederung</li> <li>• Schaft-Ø (Vorbauklemmung): 28,6 mm / 1 1/8"</li> <li>• Schaft: 1 1/8" - 1,5" tapered</li> <li>• Vorlauf: 44 mm</li> <li>• Standrohr-Ø: 38 mm</li> <li>• Einbaumaß: Boost Standard, 110 mm</li> <li>• Achssystem: Steckachse Maxle</li> <li>• Bremsaufnahme: Disc</li> <li>• Bremsscheiben-Ø min./max: 200/220 mm</li> <li>• Reifengröße (max.): 29 x 3,2"</li> <li>• Einbauhöhe: 586 mm</li> </ul>	<p><b>SUSPENSION FORK</b>                      ›ZEB SELECT CHARGER RC 29"‹</p> <ul style="list-style-type: none"> <li>• travel: 170 mm</li> <li>• suspension system: DebonAir+ air suspension</li> <li>• steerer Ø (stem): 28.6 mm / 1 1/8"</li> <li>• steerer: 1 1/8"- 1.5" tapered</li> <li>• fork offset: 44 mm</li> <li>• stanchion Ø: 38 mm</li> <li>• OLD: boost standard, 110 mm</li> <li>• axle type: thru axle Maxle</li> <li>• brake mount: disc</li> <li>• min./max. Ø brake disc: 200/220 mm</li> <li>• (max.) tire width: 29 x 3.2"</li> <li>• installation height: 586 mm</li> </ul>	 <p><b>ROCK SHOX</b></p> <p><b>BROSE GF</b></p>
<p><b>390059</b></p> <p><b>NEW</b> 10</p>	<p><b>FEDERGABEL</b>                      ›ZEB SELECT+ CHARGER 3 RC2 29"‹</p> <ul style="list-style-type: none"> <li>• Federweg: 170 mm</li> <li>• Federsystem: DebonAir+ Luftfederung</li> <li>• Schaft-Ø (Vorbauklemmung): 28,6 mm / 1 1/8"</li> <li>• Schaft: 1 1/8" - 1,5" tapered</li> <li>• Vorlauf: 51 mm</li> <li>• Standrohr-Ø: 38 mm</li> <li>• Einbaumaß: Boost Standard, 110 mm</li> <li>• Achssystem: Steckachse Maxle</li> <li>• Bremsaufnahme: Disc</li> <li>• Bremsscheiben-Ø min./max: 200/220 mm</li> <li>• Reifengröße (max.): 29 x 3,2"</li> <li>• Einbauhöhe: 586 mm</li> </ul>	<p><b>SUSPENSION FORK</b>                      ›ZEB SELECT+ CHARGER 3 RC2 29"‹</p> <ul style="list-style-type: none"> <li>• travel: 170 mm</li> <li>• suspension system: DebonAir+ air suspension</li> <li>• steerer Ø (stem): 28.6 mm / 1 1/8"</li> <li>• steerer: 1 1/8"- 1.5" tapered</li> <li>• fork offset: 51 mm</li> <li>• stanchion Ø: 38 mm</li> <li>• OLD: boost standard, 110 mm</li> <li>• axle type: thru axle Maxle</li> <li>• brake mount: disc</li> <li>• min./max. Ø brake disc: 200/220 mm</li> <li>• (max.) tire width: 29 x 3.2"</li> <li>• installation height: 586 mm</li> </ul>	 <p><b>ROCK SHOX</b></p> <p><b>BROSE GF</b></p>







ART.-NR. 	BESCHREIBUNG	DESCRIPTION	
<b>391504</b> 10	<b>FEDERGABEL</b> <b>›PIKE SELECT CHARGER RC 29"‹</b> <ul style="list-style-type: none"> <li>• Federweg: 140 mm</li> <li>• Federsystem: DebonAir+ Luftfederung</li> <li>• Schaft-Ø (Vorbauklemmung): 28,6 mm / 1 1/8"</li> <li>• Schaft: 1 1/8" - 1,5" tapered</li> <li>• Vorlauf: 44 mm</li> <li>• Standrohr-Ø: 35 mm</li> <li>• Einbaumaß: Boost Standard, 110 mm</li> <li>• Achssystem: Steckachse Maxle</li> <li>• Bremsaufnahme: Disc</li> <li>• Bremsscheiben-Ø min./max: 180/220 mm</li> <li>• Reifengröße (max.): 29 x 3,2"</li> <li>• Einbauhöhe: 551 mm</li> </ul>	<b>SUSPENSION FORK</b> <b>›PIKE SELECT CHARGER RC 29"‹</b> <ul style="list-style-type: none"> <li>• travel: 140 mm</li> <li>• suspension system: DebonAir+ air suspension</li> <li>• steerer Ø (stem): 28.6 mm / 1 1/8"</li> <li>• steerer: 1 1/8" - 1.5" tapered</li> <li>• fork offset: 44 mm</li> <li>• stanchion Ø: 35 mm</li> <li>• OLD: boost standard, 110 mm</li> <li>• axle type: thru-axle Maxle</li> <li>• brake mount: disc</li> <li>• min./max. Ø brake disc: 180/220 mm</li> <li>• (max.) tire width: 29 x 3.2"</li> <li>• installation height: 551 mm</li> </ul>	
<b>390020</b> 10	<b>FEDERGABEL</b> <b>›35 SILVER TK 29"‹</b> <ul style="list-style-type: none"> <li>• Federweg: 140 mm</li> <li>• Federsystem: Solo Air Luftfederung, mit Turnkey Lockout</li> <li>• Schaft-Ø (Vorbauklemmung): 28,6 mm / 1 1/8"</li> <li>• Schaft: 1 1/8" - 1,5" tapered</li> <li>• Vorlauf: 44 mm</li> <li>• Standrohr-Ø: 35 mm</li> <li>• Einbaumaß: Boost Standard, 110 mm</li> <li>• Achssystem: Steckachse Maxle</li> <li>• Bremsaufnahme: Disc Post Mount</li> <li>• Bremsscheiben-Ø min/max: 180/220 mm</li> <li>• Reifengröße (max.): 27,5 x 3,2"</li> <li>• Einbauhöhe: 552 mm</li> <li>• Model: FS-35S-TK-A1</li> </ul>	<b>SUSPENSION FORK</b> <b>›35 SILVER TK 29"‹</b> <ul style="list-style-type: none"> <li>• travel: 140 mm</li> <li>• suspension system: Solo Air air suspension, with Turnkey lockout</li> <li>• steerer Ø (stem): 28.6 mm / 1 1/8"</li> <li>• steerer: 1 1/8" - 1.5" tapered</li> <li>• fork offset: 44 mm</li> <li>• stanchion Ø: 35 mm</li> <li>• OLD: boost standard, 110 mm</li> <li>• axle type: thru axle Maxle</li> <li>• break mount: disc post mount</li> <li>• min./max. Ø brake disc: 180/220 mm</li> <li>• (max.) tire width: 27.5 x 3.2"</li> <li>• installation height: 552 mm</li> <li>• model: FS-35S-TK-A1</li> </ul>	
<b>390043</b> 10	<b>FEDERGABEL</b> <b>›RECON SILVER RL 27,5"‹</b> <ul style="list-style-type: none"> <li>• Federweg: 140 mm</li> <li>• Federsystem: Solo Air Luftfederung, mit Turnkey Lockout, einstellbare Low-Speed-Compression</li> <li>• Schaft-Ø (Vorbauklemmung): 28,6 mm / 1 1/8"</li> <li>• Schaft: 1 1/8" - 1,5" tapered</li> <li>• Vorlauf: 46 mm</li> <li>• Einbaumaß: Boost Standard, 110 mm</li> <li>• Achssystem: Steckachse Maxle</li> <li>• Bremsaufnahme: Disc</li> <li>• Bremsscheiben-Ø min./max: 160/220 mm</li> <li>• Reifengröße (max.): 27,5 x 2,8"</li> <li>• Einbauhöhe: 534 mm</li> </ul>	<b>SUSPENSION FORK</b> <b>›RECON SILVER RL 27.5"‹</b> <ul style="list-style-type: none"> <li>• travel: 140 mm</li> <li>• suspension system: Solo Air air suspension, with Turnkey lockout, adjustable low speed compression</li> <li>• steerer Ø (stem): 28.6 mm / 1 1/8"</li> <li>• steerer: 1 1/8" - 1.5" tapered</li> <li>• fork offset: 46 mm</li> <li>• OLD: boost standard, 110 mm</li> <li>• axle type: thru axle Maxle</li> <li>• brake mount: disc</li> <li>• min./max. Ø brake disc: 160/220 mm</li> <li>• (max.) tire width: 27.5 x 2.8"</li> <li>• installation height: 534 mm</li> </ul>	
<b>390031</b> 10	<b>FEDERGABEL</b> <b>›REBA RL-A9‹</b> <ul style="list-style-type: none"> <li>• Federweg: 100 mm</li> <li>• Federsystem: Solo Air Luftfederung</li> <li>• Schaft-Ø Vorbauklemmung: 28,6 mm / 1 1/8"</li> <li>• Schaft: 1 1/8" - 1,5" tapered</li> <li>• Vorlauf: 51 mm</li> <li>• Standrohr-Ø: 32 mm</li> <li>• Einbaumaß: Boost Standard, 110 mm</li> <li>• Achssystem: Steckachse Maxle</li> <li>• Bremsaufnahme: Disc Post Mount</li> <li>• Bremsscheiben-Ø min/max: 160 / 220 mm</li> <li>• Reifengröße (max.): 29 x 3,2"</li> <li>• Einbauhöhe: 506 mm</li> <li>• Model: FS-REBA-RL-A9</li> </ul>	<b>SUSPENSION FORK</b> <b>›REBA RL-A9‹</b> <ul style="list-style-type: none"> <li>• travel: 100 mm</li> <li>• suspension system: solo air air suspension</li> <li>• steerer Ø (stem): 28.6 mm / 1 1/8"</li> <li>• steerer: 1 1/8" - 1.5" tapered</li> <li>• fork offset: 51 mm</li> <li>• stanchion Ø: 32 mm</li> <li>• OLD: boost standard, 110 mm</li> <li>• axle type: thru axle maxle</li> <li>• brake mount: disc post mount</li> <li>• min./max. rotor size: 160 / 220 mm</li> <li>• max. tire width: 29 x 3.2"</li> <li>• installation height: 506 mm</li> <li>• model: FS-REBA-RL-A9</li> </ul>	



ART.-NR. 	BESCHREIBUNG	DESCRIPTION	
<b>390022</b> 10	<b>FEDERGABEL</b> <b>›PARAGON GOLD RL-A1‹</b> <ul style="list-style-type: none"> <li>• Federweg: 65 mm</li> <li>• Federsystem: Solo Air Luftfederung</li> <li>• Schaft-Ø Vorbauklemmung: 28,6 mm / 1 1/8"</li> <li>• Schaft: 1 1/8" - 1,5" tapered</li> <li>• Vorlauf: 46 mm</li> <li>• Standrohr-Ø: 30 mm</li> <li>• Einbaumaß: 100 mm</li> <li>• Achssystem: 9 mm Schnellspanner</li> <li>• Bremsaufnahme: Disc Post Mount</li> <li>• Bremsscheiben-Ø min/max: 160 / 180 mm</li> <li>• Reifengröße (max.): 28 x 2,8"</li> <li>• Einbauhöhe: 477 mm</li> <li>• Model: FS-Paragon Gold-RL-A1</li> </ul>	<b>SUSPENSION FORK</b> <b>›PARAGON GOLD RL-A1‹</b> <ul style="list-style-type: none"> <li>• travel: 65 mm</li> <li>• suspension system: solo air air suspension</li> <li>• steerer Ø (stem): 28.6 mm / 1 1/8"</li> <li>• steerer: 1 1/8" - 1.5" tapered</li> <li>• fork offset: 46 mm</li> <li>• stanchion Ø: 30 mm</li> <li>• OLD: 100 mm</li> <li>• axle type: 9 mm quick release</li> <li>• brake mount: disc post mount</li> <li>• min./max. rotor size: 160 / 180 mm</li> <li>• max. tire width: 28 x 2.8"</li> <li>• installation height: 477 mm</li> <li>• model: FS-Paragon Gold-RL-A1</li> </ul>	  
<b>666742</b> <b>NEW</b> 20  <b>666743</b> <b>NEW</b> 20	<b>HINTERBAUDÄMPFER</b> <b>›DELUXE SELECT +‹</b> <ul style="list-style-type: none"> <li>• Federsystem: DebonAir Luftfederung, RT-Rebound Threshold</li> <li>• Einbaumaß: <b>185 mm</b></li> <li>• Aufnahme: Trunnion</li> </ul> <p>Hub: 55 mm</p> <p>Hub: 47,5 mm</p>	<b>REAR SUSPENSION</b> <b>›DELUXE SELECT +‹</b> <ul style="list-style-type: none"> <li>• suspension system: DebonAir air suspension, RT-Rebound Threshold</li> <li>• OLD: <b>185 mm</b></li> <li>• shaft hardware: trunnion</li> </ul> <p>hub: 55 mm</p> <p>hub: 47.5 mm</p>	  
<b>666744</b> <b>NEW</b> 20  <b>666745</b> <b>NEW</b> 20	<b>HINTERBAUDÄMPFER</b> <b>›DELUXE SELECT +‹</b> <ul style="list-style-type: none"> <li>• Einbaumaß: <b>205 mm</b></li> <li>• Aufnahme: Trunnion</li> <li>• Hub: 60 mm</li> </ul> <p>Federsystem: DebonAir Luftfederung, RT -</p> <p>Federsystem: DebonAir Luftfederung</p>	<b>REAR SUSPENSION</b> <b>›DELUXE SELECT +‹</b> <ul style="list-style-type: none"> <li>• OLD: <b>205 mm</b></li> <li>• shaft hardware: trunnion</li> <li>• hub: 60 mm</li> </ul> <p>suspension system: DebonAir air air suspension, RT -</p> <p>suspension system: DebonAir air air suspension</p>	  



ART.-NR. 	BESCHREIBUNG	DESCRIPTION		
<b>SCHALTUNGSKOMPONENTEN</b> / <b>SHIFTING COMPONENTS</b>				
<b>681038</b> 20	<b>Schaltwerk GX Eagle</b> <ul style="list-style-type: none"> <li>• 12-fach</li> <li>• langer Käfig</li> <li>• Kapazität: 52 Zähne</li> <li>• Aluminium-Käfig</li> <li>• X-actuation</li> <li>• 299 g</li> </ul>	<b>Rear derailleur GX Eagle</b> <ul style="list-style-type: none"> <li>• 12 speed</li> <li>• long cage</li> <li>• capacity: 52 teeth</li> <li>• aluminium cage</li> <li>• x-actuation</li> <li>• 299 g</li> </ul>		
<b>681016</b> 20	<b>Schaltwerk NX Eagle</b> <ul style="list-style-type: none"> <li>• 12-fach</li> <li>• langer Käfig</li> <li>• Kapazität: 50 Zähne</li> <li>• Stahl-Käfig</li> <li>• X-actuation</li> <li>• 339 g</li> </ul>	<b>Rear derailleur NX Eagle</b> <ul style="list-style-type: none"> <li>• 12 speed</li> <li>• long cage</li> <li>• capacity: 50 teeth</li> <li>• steel cage</li> <li>• x-actuation</li> <li>• 339 g</li> </ul>		
<b>681020</b> 20	<b>Schalthebel GX Eagle</b> <ul style="list-style-type: none"> <li>• 12-fach</li> <li>• X-actuation</li> <li>• Matchmaker kompatibel</li> <li>• 122 g</li> </ul>	<b>Shift lever GX Eagle</b> <ul style="list-style-type: none"> <li>• 12 speed</li> <li>• X-actuation</li> <li>• matchmaker compatible</li> <li>• 122 g</li> </ul>		
<b>681017</b> 20	<b>Schalthebel NX Eagle</b> <ul style="list-style-type: none"> <li>• 12-fach</li> <li>• X-actuation</li> <li>• Matchmaker kompatibel</li> <li>• 112 g</li> </ul>	<b>Shift lever NX Eagle</b> <ul style="list-style-type: none"> <li>• 12 speed</li> <li>• X-actuation</li> <li>• matchmaker compatible</li> <li>• 112 g</li> </ul>		
<b>360140</b> <b>360141</b> 100	<b>Klemmschelle ›Matchmaker X‹</b> links rechts	<b>Lever clamp ›Matchmaker X‹</b> left right		
<b>BREMSEN UND -ZUBEHÖR</b> / <b>BRAKES AND ACCESSORIES</b>				
<b>360464</b> 20	<b>Scheibenbremse ›Guide RE‹</b> <ul style="list-style-type: none"> <li>• für Vorderrad</li> <li>• Griffweite einstellbar</li> <li>• für DOT 5.1</li> <li>• mit 950 mm Leitung</li> <li>• für Postmount System inkl. 20 mm Spacer</li> </ul>	<b>Disc brake ›Guide RE‹</b> <ul style="list-style-type: none"> <li>• for front</li> <li>• adjustable reach</li> <li>• for DOT 5.1</li> <li>• with 950 mm tube</li> <li>• for postmount system incl. 20 mm spacer</li> </ul>		
<b>360465</b> 20	<b>Scheibenbremse ›Guide RE‹</b> <ul style="list-style-type: none"> <li>• für Hinterrad</li> <li>• Griffweite einstellbar</li> <li>• für DOT 5.1</li> <li>• mit 1.650 mm Leitung</li> <li>• für Postmount System inkl. 20 mm Spacer</li> </ul>	<b>Disc brake ›Guide RE‹</b> <ul style="list-style-type: none"> <li>• for rear</li> <li>• adjustable reach</li> <li>• for DOT 5.1</li> <li>• with 1,650 mm tube</li> <li>• for postmount system incl. 20 mm spacer</li> </ul>		
<b>360490</b> 20	<b>Scheibenbremse ›Level T‹</b> <ul style="list-style-type: none"> <li>• für Vorderrad</li> <li>• für DOT 4</li> <li>• mit 950 mm Leitung</li> <li>• für Postmount System</li> </ul>	<b>Disc brake ›Level T‹</b> <ul style="list-style-type: none"> <li>• for front</li> <li>• for DOT 4</li> <li>• with 950 mm tube</li> <li>• for postmount system</li> </ul>		
<b>360491</b> 20	<b>Scheibenbremse ›Level T‹</b> <ul style="list-style-type: none"> <li>• für Hinterrad</li> <li>• für DOT 4</li> <li>• mit 1.650 mm Leitung</li> <li>• für Postmount System</li> </ul>	<b>Disc brake ›Level T‹</b> <ul style="list-style-type: none"> <li>• for rear</li> <li>• for DOT 4</li> <li>• with 1,650 mm tube</li> <li>• for postmount system</li> </ul>		

ART.-NR.	BESCHREIBUNG	DESCRIPTION	
<p><b>360498</b> 50</p> <p><b>360499</b> 100</p>	<p><b>BREMSEN UND -ZUBEHÖR</b></p> <p><b>Bremsscheibe</b></p> <ul style="list-style-type: none"> <li>• 200 mm</li> <li>• 6-Loch</li> <li>• inkl. Befestigungsschrauben</li> </ul> <p><b>Bremsscheibe</b></p> <ul style="list-style-type: none"> <li>• 203 mm</li> <li>• 6-Loch</li> <li>• inkl. Befestigungsschrauben</li> </ul>	<p><b>BRAKES AND ACCESSORIES</b></p> <p><b>Brake disc</b></p> <ul style="list-style-type: none"> <li>• 200 mm</li> <li>• 6 bolt</li> <li>• inkl. fixing screws</li> </ul> <p><b>Brake disc</b></p> <ul style="list-style-type: none"> <li>• 203 mm</li> <li>• 6 bolt</li> <li>• inkl. fixing screws</li> </ul>	
<p><b>700202</b> 20</p> <p><b>700214</b> 20</p>	<p><b>KASSETTENZAHNKRÄNZE</b></p> <p><b>Kassettenzahnkranz GX Eagle</b></p> <ul style="list-style-type: none"> <li>• 12-fach</li> <li>• 10-52 Zähne</li> </ul> <p><b>Kassettenzahnkranz NX Eagle</b></p> <ul style="list-style-type: none"> <li>• 12-fach</li> <li>• 11-50 Zähne</li> </ul>	<p><b>CASSETTE SPROCKETS</b></p> <p><b>Cassette sprocket GX Eagle</b></p> <ul style="list-style-type: none"> <li>• 12 speed</li> <li>• 10-52 teeth</li> </ul> <p><b>Cassette sprocket NX Eagle</b></p> <ul style="list-style-type: none"> <li>• 12 speed</li> <li>• 11-50 teeth</li> </ul>	
<p><b>300207</b> 50</p>	<p><b>KETTE</b></p> <ul style="list-style-type: none"> <li>• GX Eagle</li> <li>• 12-fach</li> <li>• 126 Glieder</li> <li>• silber/schwarz</li> <li>• PowerLock</li> </ul>	<p><b>CHAIN</b></p> <ul style="list-style-type: none"> <li>• GX Eagle</li> <li>• 12 speed</li> <li>• 126 links</li> <li>• silver/black</li> <li>• PowerLock</li> </ul>	
<p><b>356299</b> 20</p>	<p><b>KETTENBLATT</b></p> <ul style="list-style-type: none"> <li>• X-Sync 2</li> <li>• Stahl</li> <li>• 34 Zähne</li> <li>• Lochkreis: 104 mm</li> </ul>	<p><b>CHAINRING</b></p> <ul style="list-style-type: none"> <li>• X-Sync 2</li> <li>• steel</li> <li>• 34 teeth</li> <li>• bolt circle: 104 mm</li> </ul>	
<p><b>250006</b> 10</p> <p><b>250007</b> 10</p>	<p><b>HÖHENVERSTELLBARE SATTELSTÜTZE ›REVERB STEALTH‹</b></p> <ul style="list-style-type: none"> <li>• Aluminium</li> <li>• pneumatische Schnellhöhenverstellung während der Fahrt durch Hebel am Lenker</li> <li>• Vent Valve-Technologie für super einfaches Entlüften, direkt am Bike und ganz ohne Zerlegen der Stütze</li> <li>• Standard Remote, rechts oben oder links unten</li> <li>• Ø 31,6 mm</li> </ul> <p><b>250006</b></p> <ul style="list-style-type: none"> <li>• Länge: 414 mm</li> <li>• Höhenverstellung: 0-150 mm</li> </ul> <p><b>250007</b></p> <ul style="list-style-type: none"> <li>• Länge: 467 mm</li> <li>• Höhenverstellung: 0-175 mm</li> </ul>	<p><b>DROPPER SEAT POST ›REVERB STEALTH‹</b></p> <ul style="list-style-type: none"> <li>• aluminium</li> <li>• pneumatic quick release height adjustment while riding by a handlebar lever</li> <li>• Vent Valve technology for easy handling service without any disassembly of the post</li> <li>• standard remote, right above or left below</li> <li>• Ø 31.6 mm</li> </ul> <p><b>250006</b></p> <ul style="list-style-type: none"> <li>• length: 414 mm</li> <li>• heigth adjustment: 0-150 mm</li> </ul> <p><b>250007</b></p> <ul style="list-style-type: none"> <li>• length: 467 mm</li> <li>• heigth adjustment: 0-175 mm</li> </ul>	
<p><b>660089</b> 50</p>	<p><b>AUSFALLENDE</b></p> <p>›Universal Derailleur Hanger‹</p>	<p><b>DERAILLEUR HANGER</b></p> <p>›Universal Derailleur Hanger‹</p>	



ART.-NR. 	BESCHREIBUNG	DESCRIPTION	
<b>612030</b> 20	<b>E-BIKE MOTOR-SCHUTZHÜLLE</b> <b>›E-PROTECT CENTER‹</b> <ul style="list-style-type: none"> <li>• Universalgröße, ideal geeignet für <b>E-Bike-Motoren</b> von Shimano, Bosch, Brose, ...</li> <li>• Größe flexibel anpassbar</li> <li>• aus Neopren</li> <li>• <b>schont den Motor</b> durch Isolierung</li> <li>• <b>schützt</b> vor Kälte, Witterung und Schmutz</li> <li>• <b>verhindert</b> Kratzer, Steinschlag und Stoßschäden</li> <li>• in M-Wave Eurolochbox</li> </ul>	<b>E-BIKE MOTOR PROTECTION COVER</b> ›E-PROTECT CENTER‹ <ul style="list-style-type: none"> <li>• universal size, ideally suitable for <b>e-bike motors</b> of Shimano, Bosch, Brose, ...</li> <li>• size flexibly adaptable</li> <li>• made of neoprene</li> <li>• <b>protects the motor</b> through isolation</li> <li>• <b>protects</b> from coldness, weather condition and dirt</li> <li>• <b>prevents</b> scratches, stone chipping and shock damages</li> <li>• in M-Wave eurohole box</li> </ul> <p style="text-align: right;">UVP 27,90 €</p>	 
<b>612010</b> 40/10	<b>E-BIKE AKKU-SCHUTZHÜLLE</b> <b>›E-PROTECT‹</b> <ul style="list-style-type: none"> <li>• <b>universell passend</b> für Bosch und Shimano Unterrohrakkus (kein original Bosch oder Shimano Ersatzteil)</li> <li>• <b>verlängerte Akkulaufzeit</b> durch Isolierung</li> <li>• aus Neopren</li> <li>• <b>Schutz</b> vor Kälte und Witterung</li> <li>• Schutz vor Kratzern, Steinschlag und Stoßschäden</li> <li>• in M-Wave Eurolochbox</li> </ul>	<b>E-BIKE BATTERY PROTECTION</b> <b>›E-PROTECT‹</b> <ul style="list-style-type: none"> <li>• <b>universal suitable</b> for Bosch and Shimano down tube batteries (no original Bosch or Shimano spare part)</li> <li>• isolation provides <b>extended battery capacity</b></li> <li>• made of neoprene</li> <li>• <b>protection</b> from coldness and weather condition</li> <li>• protection from scratches, stone chipping and shock damages</li> <li>• in M-Wave eurohole box</li> </ul> <p style="text-align: right;">UVP 11,90 €</p>	   
<b>612021</b> 40/5	<b>E-BIKE AKKU-SCHUTZHÜLLE</b> <b>›E-PROTECT WRAP‹</b> <ul style="list-style-type: none"> <li>• <b>Universalgröße</b> für in den Rahmen integrierte E-Bikes Akkus</li> <li>• <b>verlängerte Akkulaufzeit</b> durch Isolierung</li> <li>• <b>Schutz</b> vor Kälte und Witterung, Kratzern, Steinschlag und Stoßschäden</li> <li>• aus Neopren</li> <li>• in M-Wave Eurolochbox</li> </ul>	<b>E-BIKE BATTERY PROTECTION COVER</b> ›E-PROTECT WRAP‹ <ul style="list-style-type: none"> <li>• <b>universal size</b> for in the frame integrated e-bike batteries</li> <li>• isolation provides <b>extended battery capacity</b></li> <li>• <b>protection</b> from coldness and weather condition, scratches, stone chipping and shock damages</li> <li>• made of neoprene</li> <li>• in M-Wave eurohole box</li> </ul> <p style="text-align: right;">UVP 16,90 €</p>	 
<b>612020</b> 40/10	<b>E-BIKE AKKU-SCHUTZHÜLLE</b> <b>›E-PROTECT CARRIER‹</b> <ul style="list-style-type: none"> <li>• Universalgröße, ideal geeignet für <b>Gepäckträgerakkus</b> von Bosch (und Shimano)</li> <li>• <b>verlängerte Akkulaufzeit</b> durch Isolierung</li> <li>• <b>Schutz</b> vor Kälte und Witterung</li> <li>• Schutz vor Kratzern, Steinschlag und Stoßschäden</li> <li>• aus Neopren</li> <li>• <b>mit Öffnung zum Laden</b> des Akkus im Gepäckträger (bei Bosch)</li> <li>• in M-Wave Eurolochbox</li> </ul>	<b>E-BIKE BATTERY PROTECTION COVER</b> ›E-PROTECT CARRIER‹ <ul style="list-style-type: none"> <li>• universal size, ideally suitable for <b>carrier batteries</b> from Bosch (and Shimano)</li> <li>• isolation provides <b>extended battery capacity</b></li> <li>• <b>protection</b> from coldness and weather condition</li> <li>• protection from scratches, stone chipping and shock damages</li> <li>• made of neoprene</li> <li>• <b>with opening to charge</b> the battery inside the carrier (Bosch battery)</li> <li>• in M-Wave eurohole box</li> </ul> <p style="text-align: right;">UVP 21,90 €</p>	  



ART.-NR.	BESCHREIBUNG	DESCRIPTION	
<b>122538</b> 16	<b>E-BIKE AKKUTASCHE ›ROUGH RIDE B‹</b> <ul style="list-style-type: none"> <li>• universeller, gepolsterter <b>Transport-schutz</b> für Unterrohr- und Gepäck-trägerakkus</li> <li>• <b>100 % wasserdicht</b></li> <li>• Rollverschluss ermöglicht <b>variable Größeneinstellung</b></li> <li>• hohe Reißfestigkeit durch verstärktes Ripstop-Gewebe</li> <li>• <b>universelle</b> und <b>sichere</b> Befestigung durch breite Klettverschlüsse am <b>Rahmenrohr, Gepäckträger, ...</b></li> <li>• mit non-slip Einlagen und <b>Reflexlogo</b></li> <li>• Größe: ca. 55 x 8,5 x 13 cm (L x B x H)</li> <li>• Volumen ca. 7 L</li> </ul>	<b>E-BIKE BATTERY BAG ›ROUGH RIDE B‹</b> <ul style="list-style-type: none"> <li>• universal, padded <b>transport protection</b> for down tube and carrier batteries</li> <li>• <b>100 % waterproof</b></li> <li>• <b>expandable</b> via roll cover</li> <li>• high tear resistance through reinforced ripstop textile</li> <li>• <b>universal</b> and <b>secure</b> mounting to the <b>frame tube, carrier, ...</b> with wide hook and loop fasteners</li> <li>• with non-slip inlays and <b>reflex logo</b></li> <li>• size: approx. 55 x 8.5 x 13 cm (L x W x H)</li> <li>• volume approx. 7 litres</li> </ul>	     <p style="text-align: right;">UVP 37,90 €</p>
<b>612022</b> 250/10	<b>E-BIKE AKKU KONTAKTSCHUTZ ›E-PROTECT CONNECT‹</b> <ul style="list-style-type: none"> <li>• <b>Universalgröße</b> zur <b>Abdeckung der Anschlusskontakte</b> am Rahmen bei entnommenen E-Bike Akkus</li> <li>• Schutz vor Schmutz, Wasser und Beschädigung</li> <li>• aus Neopren</li> <li>• auf M-Wave Eurolochkarte</li> </ul>	<b>E-BIKE BATTERY CONNECTOR COVER ›E-PROTECT CONNECT‹</b> <ul style="list-style-type: none"> <li>• <b>universal size to cover the connection contacts</b> of the frame with removed e-bike batteries</li> <li>• protection from dirt, water and damages</li> <li>• made of neoprene</li> <li>• on M-Wave eurohole card</li> </ul>	    <p style="text-align: right;">UVP 9,90 €</p>
<b>612040</b> 100	<b>COCKPIT-/LENKER-ABDECKUNG</b> <ul style="list-style-type: none"> <li>• schützt <b>E-Bike Displays</b>, Schalt- und Bremshebel, Computer, ... vor Staub, Schmutz, Regen, ...</li> <li>• wasserabweisend</li> <li>• universell passend für (fast) alle Lenkerformen</li> <li>• mit Gummizug und 4 Klettverschlüssen</li> <li>• auf M-Wave Eurolochkarte</li> </ul>	<b>COCKPIT/HANDLEBAR COVER</b> <ul style="list-style-type: none"> <li>• protects <b>e-bike displays</b>, shift and brake levers, computer, ... against dust, dirt, rain, ...</li> <li>• water resistant</li> <li>• universally suitable for (almost) all handlebar shapes</li> <li>• with rubber band and 4 hook and loop fasteners</li> <li>• on M-Wave eurohole card</li> </ul>	    <p style="text-align: right;">UVP 11,90 €</p>
<b>612027</b> 250	<b>E-BIKE REMOTE UND DISPLAY SCHUTZ ›E-PROTECT‹</b> <ul style="list-style-type: none"> <li>• aus wasserabweisendem <b>Neopren</b></li> <li>• <b>universell passend</b> für (fast) alle <b>Remote-</b> und <b>Mitteldisplays</b> durch extra langen Klett- und zusätzlichen Kordelverschluss</li> <li>• optimaler Schutz für Displays, Lenkerfernbedienungen, Anschlusskontakte, ...</li> <li>• auf M-Wave Eurolochkarte</li> </ul>	<b>E-BIKE REMOTE AND DISPLAY PROTECTION ›E-PROTECT‹</b> <ul style="list-style-type: none"> <li>• water resistant <b>neoprene</b> material</li> <li>• <b>universally suitable</b> for (almost) all <b>remote</b> and <b>center displays</b> due to extra long hook and loop fastener and cord strap</li> <li>• perfect protection for displays, remote lever, connection contacts, ...</li> <li>• on M-Wave eurohole card</li> </ul>	     <p style="text-align: right;">UVP 6,90 €</p>

# LITEMOVE

## LED-Beleuchtung in aktueller Optik und höchster Qualität

- + Jahrzehntelange Erfahrung in Optik und Elektronik
- + Top-Qualitätsprodukte zu interessanten Preisen
- + Umweltfreundliche Verpackungen ohne Plastik

### Neu 2023

- + Kabelhüllen ohne PVC
- + Nachhaltiges Produktdesign durch wasserfeste Schalter
- + Unterstützung des Circular Economy Action Plan der EU

## LED lights in stylish and modern appearance with highest quality

- + decades of experience in optics and electronics
- + top quality products at interesting prices
- + eco-friendly packaging without plastic

### New in 2023

- + cable coatings without PVC
- + sustainable product design  
with water resistant switches
- + support of the Circular Economy  
Action Plan of the EU

LITEMOVE   
PERFORMANCE | HIGH BEAM

ART.-NR.	BESCHREIBUNG	DESCRIPTION	E-BIKE BATTERY → GLEICHSTROM/DC
<b>461643</b> 120 <b>NEW</b>	<b>E-BIKE SCHEINWERFER &gt;AEW-230&lt;</b> <ul style="list-style-type: none"> <li>• Fern- und Abblendlicht</li> <li>• mit Lenkerfernbedienung</li> <li>• <b>230 / 170 Lux</b></li> <li>• 9 - 16 V DC / 7,3 W (Abblendlicht) - 15 W (Fernlicht)</li> <li>• <b>4 Hochleistungs-LEDs</b></li> <li>• <b>Aluminiumgehäuse</b></li> <li>• mit 1.400 mm Verbindungskabel</li> <li>• 3 Montageoptionen</li> <li>• mit deutschem Prüfzeichen</li> <li>• 165 g</li> <li>• Montageverpackung</li> </ul>	<b>E-BIKE HEAD LAMP &gt;AEW-230&lt;</b> <ul style="list-style-type: none"> <li>• high and low beam</li> <li>• with handlebar remote control</li> <li>• <b>230 / 170 lux</b></li> <li>• 9 - 16 V DC / 7.3 W (low beam) - 15 W (high beam)</li> <li>• <b>4 high performance LEDs</b></li> <li>• aluminium housing</li> <li>• with 1,400 mm connecting cable</li> <li>• 3 mounting options</li> <li>• with German approval number</li> <li>• 165 g</li> <li>• OEM</li> </ul>	 <p>UVP 219,00 €</p>
<b>461627</b> 120 <b>NEW</b>	<b>E-BIKE SCHEINWERFER &gt;AE-130&lt;</b> <ul style="list-style-type: none"> <li>• Fern- und Abblendlicht</li> <li>• mit Lenkerfernbedienung</li> <li>• <b>130 / 90 Lux</b></li> <li>• <b>4 Hochleistungs-LEDs</b></li> <li>• 6 - 16 V DC / 6 W (Abblendlicht) - 13 W (Fernlicht)</li> <li>• <b>Aluminiumgehäuse</b></li> <li>• mit 1.400 mm Verbindungskabel</li> <li>• für <b>Lenkermontage links</b> (andere Versionen auf Anfrage erhältlich)</li> <li>• mit deutschem Prüfzeichen</li> <li>• 120 g</li> <li>• Montageverpackung</li> </ul>	<b>E-BIKE HEAD LAMP &gt;AE-130&lt;</b> <ul style="list-style-type: none"> <li>• high and low beam</li> <li>• with handlebar remote control</li> <li>• <b>130 / 90 lux</b></li> <li>• <b>4 high intensity LEDs</b></li> <li>• 6 - 16 V DC / 6 W (low beam) - 13 W (high beam)</li> <li>• aluminium housing</li> <li>• with 1,400 mm connection cable</li> <li>• for <b>handlebar mounting on the left</b> (other versions available on request)</li> <li>• with German approval number</li> <li>• 120 g</li> <li>• OEM</li> </ul>	 <p>UVP 184,00 €</p>



ART.-NR. 	BESCHREIBUNG	DESCRIPTION	 <b>E-BIKE BATTERY</b> → GLEICHSTROM/DC
<b>461647</b> 120 <b>NEW</b>	<b>E-BIKE SCHEINWERFER</b> <b>›SEW-170‹</b> <ul style="list-style-type: none"> <li>• <b>170 Lux</b></li> <li>• 9 - 16 V DC / 7,3 W</li> <li>• 2 Hochleistungs-LEDs</li> <li>• <b>Aluminiumgehäuse</b></li> <li>• mit 1.400 mm Verbindungskabel</li> <li>• 3 Montageoptionen</li> <li>• mit deutschem Prüfzeichen</li> <li>• 120 g</li> <li>• Montageverpackung</li> </ul>	<b>E-BIKE HEAD LAMP</b> <b>›SEW-170‹</b> <ul style="list-style-type: none"> <li>• <b>170 lux</b></li> <li>• 9 - 16 V DC / 7.3 W</li> <li>• 2 high performance LEDs</li> <li>• <b>aluminium housing</b></li> <li>• with 1,400 mm connecting cable</li> <li>• 3 mounting options</li> <li>• with german approval number</li> <li>• 120 g</li> <li>• OEM</li> </ul>	 <p><b>170 LUX</b></p> <p>UVP 165,00 €</p>
<b>461610</b> 120 <b>NEW</b>	<b>E-BIKE SCHEINWERFER</b> <b>›SE-150‹</b> <ul style="list-style-type: none"> <li>• <b>150 Lux</b></li> <li>• 5 - 16 V DC / 7,2 W</li> <li>• <b>2 Hochleistungs-LEDs</b></li> <li>• <b>Aluminiumgehäuse</b></li> <li>• mit 1.400 mm Verbindungskabel</li> <li>• <b>Version für Gabelmontage</b> (andere Versionen auf Anfrage erhältlich)</li> <li>• mit deutschem Prüfzeichen</li> <li>• 91 g</li> <li>• Montageverpackung</li> </ul>	<b>E-BIKE HEAD LAMP</b> <b>›SE-150‹</b> <ul style="list-style-type: none"> <li>• <b>150 lux</b></li> <li>• 5 - 16 V DC / 7.2 W</li> <li>• <b>2 high intensity LEDs</b></li> <li>• <b>aluminium housing</b></li> <li>• with 1,400 mm connecting cable</li> <li>• <b>version for fork mounting</b> (other versions available on request)</li> <li>• with German approval number</li> <li>• 91 g</li> <li>• OEM</li> </ul>	 <p><b>150 LUX</b></p> <p>UVP 79,90 €</p>
<b>461611</b> 120	<b>E-BIKE SCHEINWERFER</b> <b>›SE-110‹</b> <ul style="list-style-type: none"> <li>• <b>110 Lux</b></li> <li>• 5 - 16 V DC / 5,6 W</li> <li>• <b>2 Hochleistungs-LEDs</b></li> <li>• <b>Aluminium-/ Kunststoffgehäuse</b></li> <li>• mit 1.400 mm Verbindungskabel</li> <li>• mit deutschem Prüfzeichen</li> <li>• 83 g</li> <li>• Montageverpackung</li> </ul>	<b>E-BIKE HEAD LAMP</b> <b>›SE-110‹</b> <ul style="list-style-type: none"> <li>• <b>110 lux</b></li> <li>• 5 - 16 V DC / 5.6 W</li> <li>• <b>2 high intensity LEDs</b></li> <li>• <b>aluminium / plastic housing</b></li> <li>• with 1,400 mm connecting cable</li> <li>• with German approval number</li> <li>• 83 g</li> <li>• OEM</li> </ul>	 <p><b>110 LUX</b></p> <p>UVP 65,90 €</p>
<b>461624</b> 120 <b>NEW</b>	<b>E-BIKE SCHEINWERFER</b> <b>›SE-90‹</b> <ul style="list-style-type: none"> <li>• <b>90 Lux</b></li> <li>• 5 - 16 V DC / 3,2 W</li> <li>• <b>1 Hochleistungs-LED</b></li> <li>• <b>Kunststoffgehäuse</b></li> <li>• mit 1.400 mm Verbindungskabel</li> <li>• <b>für Gabelmontage</b> (andere Versionen auf Anfrage erhältlich)</li> <li>• mit deutschem Prüfzeichen</li> <li>• 66 g</li> <li>• Montageverpackung</li> </ul>	<b>E-BIKE HEAD LAMP</b> <b>›SE-90‹</b> <ul style="list-style-type: none"> <li>• <b>90 lux</b></li> <li>• 5 - 16 V DC / 3.2 W</li> <li>• <b>1 high intensity LED</b></li> <li>• <b>plastic housing</b></li> <li>• with 1,400 mm connecting cable</li> <li>• <b>for fork mounting</b> (other versions available on request)</li> <li>• with German approval number</li> <li>• 66 g</li> <li>• OEM</li> </ul>	 <p><b>90 LUX</b></p> <p>UVP 49,90 €</p>



ART.-NR. 	BESCHREIBUNG	DESCRIPTION	 E-BIKE BATTERY → GLEICHSTROM/DC
<b>461612</b> 120 <b>NEW</b>	<b>E-BIKE SCHEINWERFER ›SE-70‹</b> <ul style="list-style-type: none"> <li>• <b>70 Lux</b></li> <li>• 5 - 16V DC / 2,7 W</li> <li>• <b>1 Hochleistungs-LED</b></li> <li>• Kunststoffgehäuse</li> <li>• mit 1.400 mm Verbindungskabel</li> <li>• <b>für Gabelmontage</b></li> <li>• mit deutschem Prüfzeichen</li> <li>• 66 g</li> <li>• Montageverpackung</li> </ul>	<b>E-BIKE HEAD LAMP ›SE-70‹</b> <ul style="list-style-type: none"> <li>• <b>70 lux</b></li> <li>• 5 - 16V DC / 2.7 W</li> <li>• <b>1 high intensity LED</b></li> <li>• plastic housing</li> <li>• with 1,400 mm connecting cable</li> <li>• <b>for fork mounting</b></li> <li>• with German approval number</li> <li>• 66 g</li> <li>• OEM</li> </ul>	  <p><b>70 LUX</b></p> <p>UVP 42,90 €</p>
<b>461648</b> 120 <b>NEW</b>	<b>E-BIKE SCHEINWERFER ›RX-E50‹</b> <ul style="list-style-type: none"> <li>• <b>50 Lux</b></li> <li>• 5 - 16V DC / 2,5 W</li> <li>• <b>1 Hochleistungs-LED</b></li> <li>• Kunststoffgehäuse</li> <li>• mit 1.400 mm Verbindungskabel</li> <li>• verschiedene Montageoptionen</li> <li>• mit deutschem Prüfzeichen</li> <li>• 18,5 g</li> <li>• Montageverpackung</li> </ul>	<b>E-BIKE HEAD LAMP ›RX-E50‹</b> <ul style="list-style-type: none"> <li>• <b>50 lux</b></li> <li>• 5 - 16V DC / 2.5 W</li> <li>• <b>1 high intensity LED</b></li> <li>• plastic housing</li> <li>• with 1,400 mm connecting cable</li> <li>• different mounting options</li> <li>• with German approval number</li> <li>• 18.5 g</li> <li>• OEM</li> </ul>	  <p><b>50 LUX</b></p> <p>UVP 34,90 €</p>
<b>461686</b> 120 <b>NEW</b>	<b>RETRO-REFLEKTOR ›RFDT‹</b> <ul style="list-style-type: none"> <li>• passend für Art. 461648</li> <li>• mit deutschem Prüfzeichen</li> <li>• Montageverpackung</li> </ul>	<b>RETRO REFLECTOR ›RFDT‹</b> <ul style="list-style-type: none"> <li>• suitable for art. 461648</li> <li>• with german approval number</li> <li>• OEM</li> </ul>	  <p>UVP 4,90 €</p>
<b>461682</b> 120 <b>NEW</b>	<b>RETRO-REFLEKTOR ›RFD‹</b> <ul style="list-style-type: none"> <li>• passend für Art. 461627/43/44/47</li> <li>• mit deutschem Prüfzeichen</li> <li>• Montageverpackung</li> </ul>	<b>RETRO REFLECTOR ›RFD‹</b> <ul style="list-style-type: none"> <li>• suitable for art. 461627/43/44/47</li> <li>• with german approval number</li> <li>• OEM</li> </ul>	  <p>UVP 4,90 €</p>
<b>461617</b> 120	<b>RETRO-REFLEKTOR ›RF1B‹</b> <ul style="list-style-type: none"> <li>• passend für Art. 461610/11/12/24/...</li> <li>• mit deutschem Prüfzeichen</li> <li>• Montageverpackung</li> </ul>	<b>RETRO REFLECTOR ›RF1B‹</b> <ul style="list-style-type: none"> <li>• for art. 461610/11/12/24/...</li> <li>• with German approval number</li> <li>• OEM</li> </ul>	  <p>UVP 4,90 €</p>

ART.-NR. 	BESCHREIBUNG	DESCRIPTION	
<b>461684</b> 120 <b>NEW</b>	<b>LENKERHALTER ›PHB31850‹</b> <ul style="list-style-type: none"> <li>• für Lenker Ø 31,8 - 35,0 mm</li> <li>• passend für Art. 461627/43/44/47</li> <li>• Montageverpackung</li> </ul>	<b>HANDLEBAR BRACKET ›PHB31850‹</b> <ul style="list-style-type: none"> <li>• for handlebar Ø 31.8 - 35.0 mm</li> <li>• suitable for art. 461627/43/44/47</li> <li>• OEM</li> </ul>	  UVP 12,90 €
<b>461614</b> 120	<b>HALTERUNG FÜR (E-BIKE) SCHEINWERFER ›FK2A‹</b> <ul style="list-style-type: none"> <li>• <b>Aluminium</b></li> <li>• passend für Art. 461610/11/12/24/...</li> <li>• Winkel <b>verstellbar</b></li> <li>• Muttern und Schrauben aus <b>Nirosta</b></li> <li>• Montageverpackung</li> </ul>	<b>BRACKET FOR (E-BIKE) HEAD LAMP ›FK2A‹</b> <ul style="list-style-type: none"> <li>• <b>aluminium</b></li> <li>• for art. 461610/11/12/24/...</li> <li>• <b>adjustable</b> angle</li> <li>• <b>stainless</b> nuts and bolts</li> <li>• OEM</li> </ul>	  UVP 17,90 €
<b>461615</b> 120	<b>HALTERUNG FÜR (E-BIKE) SCHEINWERFER ›FKPL‹</b> <ul style="list-style-type: none"> <li>• Universal-Gabelhalterung</li> <li>• Mutter und Schraube aus <b>Edelstahl</b></li> <li>• passend für Art. 461610/11/12/24/...</li> <li>• Montageverpackung</li> </ul>	<b>BRACKET FOR (E-BIKE) HEAD LAMP ›FKPL‹</b> <ul style="list-style-type: none"> <li>• universal fork bracket</li> <li>• <b>stainless</b> nut and bolt</li> <li>• for art. 461610/11/12/24/...</li> <li>• OEM</li> </ul>	  UVP 4,90 €
<b>461616</b> 120 <b>NEW</b>	<b>HALTERUNG FÜR E-BIKE SCHEINWERFER ›STU-3B‹</b> <ul style="list-style-type: none"> <li>• Gabelhalterung für Suntour MOBIE 45/25 und MOBIE A32</li> <li>• passend für Art. 461610/11/12, 461624/48</li> <li>• Montageverpackung</li> </ul>	<b>BRACKET FOR E-BIKE HEAD LAMP ›STU3B‹</b> <ul style="list-style-type: none"> <li>• fork bracket for Suntour MOBIE45/25 und MOBIE A32</li> <li>• suitable for art. 461610/11/12, 461624/48</li> <li>• OEM</li> </ul>	  UVP 5,90 €
<b>461618</b> 120 <b>NEW</b>	<b>HALTERUNG FÜR E-BIKE SCHEINWERFER ›STU-4B‹</b> <ul style="list-style-type: none"> <li>• Gabelhalterung für Suntour SF-20-NEX-E25</li> <li>• passend für Art. 461610/11/12, 461624/48</li> <li>• Montageverpackung</li> </ul>	<b>BRACKET FOR E-BIKE HEAD LAMP ›STU4B‹</b> <ul style="list-style-type: none"> <li>• fork bracket for Suntour SF-20-NEX-E25</li> <li>• suitable for art. 461610/11/12, 461624/48</li> <li>• OEM</li> </ul>	  UVP 4,90 €
<b>461681</b> 120 <b>NEW</b>	<b>ADAPTER ›AP2B‹</b> <ul style="list-style-type: none"> <li>• passend für Art. 461643/44/47</li> <li>• für GoPro</li> <li>• (kein original GoPro Ersatzteil)</li> <li>• Montageverpackung</li> </ul>	<b>ADAPTER ›AP2B‹</b> <ul style="list-style-type: none"> <li>• suitable for art. 461643/44/47</li> <li>• for GoPro</li> <li>• (no original GoPro spare part)</li> <li>• OEM</li> </ul>	   UVP 5,90 €



















ART.-NR. 	BESCHREIBUNG	DESCRIPTION	 <b>E-BIKE BATTERY</b> → GLEICHSTROM/DC
<b>461626</b> 120 <b>NEW</b>	<b>E-BIKE GEPÄCKTRÄGER-RÜCKLICHT ›TA-KA‹</b> <ul style="list-style-type: none"> <li>• mit Bremslicht</li> <li>• 2 rote LEDs</li> <li>• 240° Abstrahlwinkel für breite Sichtbarkeit</li> <li>• abgeschrägte Schutzkanten</li> <li>• 6 - 16 V DC / 0,5 W – 4,3 W</li> <li>• mit deutschem Prüfzeichen</li> <li>• für 50 mm und 80 mm Lochabstandsmontage</li> <li>• mit 1.700 mm Verbindungskabel</li> <li>• 31 g</li> <li>• Montageverpackung</li> </ul>	<b>E-BIKE CARRIER REAR LIGHT ›TA-KA‹</b> <ul style="list-style-type: none"> <li>• with brake light</li> <li>• 2 red LEDs</li> <li>• 240° wide visibility</li> <li>• chamfered edges to prevent damage</li> <li>• 6 - 16 V DC / 0.5 W – 4.3 W</li> <li>• with German approval number</li> <li>• for 50 mm and 80 mm hole spacing mounting</li> <li>• with 1,700 mm connecting cable</li> <li>• 31 g</li> <li>• OEM</li> </ul>	  
<b>461625</b> 120 <b>NEW</b>	<b>E-BIKE GEPÄCKTRÄGER-RÜCKLICHT ›TA-KS‹</b> <ul style="list-style-type: none"> <li>• wie Art. 461626, aber ohne Bremslicht</li> <li>• 1 rote LED</li> <li>• 6 - 16 V DC / 0,5 W</li> <li>• mit 1.400 mm Verbindungskabel</li> <li>• 33 g</li> </ul>	<b>E-BIKE CARRIER REAR LIGHT ›TA-KS‹</b> <ul style="list-style-type: none"> <li>• like art. 461626, but without brake light</li> <li>• 1 red LED</li> <li>• 6 - 16 V DC / 0.5 W</li> <li>• with 1,400 mm connecting cable</li> <li>• 33 g</li> </ul>	 
<b>461620</b> 120	<b>E-BIKE GEPÄCKTRÄGER RÜCKLICHT ›TS-RR‹</b> <ul style="list-style-type: none"> <li>• 4 rote LEDs</li> <li>• 4,5 - 16 V DC / 0,6 W</li> <li>• mit deutschem Prüfzeichen</li> <li>• nur 23 g</li> <li>• für 80 mm Lochabstandsmontage</li> <li>• mit 1.400 mm Verbindungskabel</li> <li>• Montageverpackung</li> </ul>	<b>E-BIKE CARRIER REAR LIGHT ›TS-RR‹</b> <ul style="list-style-type: none"> <li>• 4 red LEDs</li> <li>• 4.5 - 16 V DC / 0.6 W</li> <li>• with German approval number</li> <li>• only 23 g</li> <li>• for 80 mm hole spacing mounting</li> <li>• with 1,400 mm connecting cable</li> <li>• OEM</li> </ul>	 
<b>461683</b> 120 <b>NEW</b>	<b>REFLEKTOR ›RF2F‹</b> <ul style="list-style-type: none"> <li>• passend für Art. 461620</li> <li>• Z-Reflektor</li> <li>• mit deutschem Prüfzeichen</li> <li>• Montageverpackung</li> </ul>	<b>REFLECTOR ›RF2F‹</b> <ul style="list-style-type: none"> <li>• suitable for art. 461620</li> <li>• Z-reflector</li> <li>• with German approval number</li> <li>• OEM</li> </ul>	  
<b>461605</b> 100 <b>NEW</b>	<b>E-BIKE SCHUTZBLECH-RÜCKLICHT ›TL-FD‹</b> <ul style="list-style-type: none"> <li>• zur Montage am Schutzblech</li> <li>• COB Hochleistungsleuchtband mit 16 LED-Chips</li> <li>• 5 - 16 V DC / 0,6 W</li> <li>• mit deutschem Prüfzeichen</li> <li>• mit 1.400 mm Verbindungskabel</li> <li>• 11 g</li> <li>• inkl. Befestigungsschrauben</li> <li>• Montageverpackung</li> </ul>	<b>E-BIKE MUDGUARD REAR LIGHT ›TL-FD‹</b> <ul style="list-style-type: none"> <li>• mounting on mudguard</li> <li>• COB high performance light band with 16 LED chips</li> <li>• 5 - 16 V DC / 0.6 W</li> <li>• with German approval number</li> <li>• with 1,400 mm connecting cable</li> <li>• 11 g</li> <li>• incl. screws</li> <li>• OEM</li> </ul>	 











**SHIMANO**



ART.-NR.	BESCHREIBUNG	DESCRIPTION	
<p><b>587830</b> 25</p> <p><b>587829</b> 12</p> <p><b>587828</b> 20</p>	<p><b>SHIMANO DEORE XT (HG) 12-Gang</b></p> <p><b>Schaltwerk RD-M8100 SGS</b></p> <ul style="list-style-type: none"> <li>• Top-Normal</li> <li>• in Shimano Eurolochbox</li> </ul> <p><b>Kassetten-Zahnkranz CS-M8100</b></p> <ul style="list-style-type: none"> <li>• 10-51 Zähne</li> <li>• Microspline</li> <li>• in Shimano Eurolochbox</li> </ul> <p><b>Schalthebel SL-M8100-R</b></p> <ul style="list-style-type: none"> <li>• rechts</li> <li>• im Shimano Einzelkarton</li> </ul>	<p><b>SHIMANO DEORE XT (HG) 12 speed</b></p> <p><b>Rear derailleur RD-M8100 SGS</b></p> <ul style="list-style-type: none"> <li>• top normal</li> <li>• in Shimano eurohole box</li> </ul> <p><b>Cassette sprocket CS-M8100</b></p> <ul style="list-style-type: none"> <li>• 10-51 teeth</li> <li>• Microspline</li> <li>• in Shimano eurohole box</li> </ul> <p><b>Shift lever SL-M8100-R</b></p> <ul style="list-style-type: none"> <li>• right</li> <li>• in Shimano box</li> </ul>	      
<p><b>580483</b> 25</p> <p><b>580482</b> 10</p> <p><b>580484</b> 10</p>	<p><b>SHIMANO SLX (HG) 12-Gang</b></p> <p><b>Schaltwerk RD-M7100 SGS</b></p> <ul style="list-style-type: none"> <li>• Top-Normal</li> <li>• in Shimano Eurolochbox</li> </ul> <p><b>Kassetten-Zahnkranz CS-M7100</b></p> <ul style="list-style-type: none"> <li>• 10-51 Zähne</li> <li>• Microspline</li> <li>• in Shimano Eurolochbox</li> </ul> <p><b>Schalthebel SL-M7100-R</b></p> <ul style="list-style-type: none"> <li>• rechts</li> <li>• in Shimano Eurolochbox</li> </ul>	<p><b>SHIMANO SLX (HG) 12 speed</b></p> <p><b>Rear derailleur RD-M7100 SGS</b></p> <ul style="list-style-type: none"> <li>• top normal</li> <li>• in Shimano eurohole box</li> </ul> <p><b>Cassette sprocket CS-M7100</b></p> <ul style="list-style-type: none"> <li>• 10-51 teeth</li> <li>• Microspline</li> <li>• in Shimano eurohole box</li> </ul> <p><b>Shift lever SL-M7100-R</b></p> <ul style="list-style-type: none"> <li>• right</li> <li>• in Shimano eurohole box</li> </ul>	     
<p><b>587840</b> 25</p> <p><b>587837</b> 12</p> <p><b>586216</b> 50</p> <p><b>586442</b> 10 set</p>	<p><b>SHIMANO DEORE (HG) 12-Gang</b></p> <p><b>Schaltwerk RD-M6100 SGS</b></p> <ul style="list-style-type: none"> <li>• Top-Normal</li> <li>• Shadow Plus Design</li> <li>• in Shimano Eurolochbox</li> </ul> <p><b>Kassetten-Zahnkranz CS-M6100-12</b></p> <ul style="list-style-type: none"> <li>• 10-51 Zähne</li> <li>• Microspline</li> <li>• in Shimano Eurolochbox</li> </ul> <p><b>Schalthebel SL-M6100-R</b></p> <ul style="list-style-type: none"> <li>• rechts</li> <li>• Montageverpackung</li> </ul> <p><b>Kettenradgarnitur FC-MT510-1</b></p> <ul style="list-style-type: none"> <li>• 32 Zähne</li> <li>• 175 mm Aluminium-Kurbel</li> <li>• Montageverpackung</li> </ul>	<p><b>SHIMANO DEORE (HG) 12 speed</b></p> <p><b>Rear derailleur RD-M6100 SGS</b></p> <ul style="list-style-type: none"> <li>• top normal</li> <li>• shadow plus design</li> <li>• in Shimano eurohole box</li> </ul> <p><b>Cassette sprocket CS-M6100-12</b></p> <ul style="list-style-type: none"> <li>• 10-51 teeth</li> <li>• Microspline</li> <li>• in Shimano eurohole box</li> </ul> <p><b>Shift lever SL-M6100-R</b></p> <ul style="list-style-type: none"> <li>• right</li> <li>• OEM</li> </ul> <p><b>Chainwheel set FC-MT510-1</b></p> <ul style="list-style-type: none"> <li>• 32 teeth</li> <li>• 175 mm aluminium crank</li> <li>• OEM</li> </ul>	     











ART.-NR. 	BESCHREIBUNG	DESCRIPTION	
<p><b>587850</b> 25</p> <p><b>587855</b> 10 <b>NEW</b></p> <p><b>587852</b> 20</p>	<p><b>SHIMANO DEORE XT LG (LINK GLIDE) 11-Gang</b></p> <p><b>Schaltwerk</b> RD-M8130 SGS</p> <ul style="list-style-type: none"> <li>• Top-Normal</li> <li>• Shadow Plus Design</li> <li>• in Shimano Eurolochbox</li> </ul> <p><b>Kassetten-Zahnkranz</b> CS-LG700-11150</p> <ul style="list-style-type: none"> <li>• 11-50 Zähne</li> <li>• in Shimano Eurolochbox</li> </ul> <p><b>Schalthebel</b> SL-M8130-R</p> <ul style="list-style-type: none"> <li>• rechts</li> <li>• im Shimano Einzelkarton</li> </ul>	<p><b>SHIMANO DEORE XT LG (LINK GLIDE) 11 speed</b></p> <p><b>Rear derailleur</b> RD-M8130 SGS</p> <ul style="list-style-type: none"> <li>• top normal</li> <li>• shadow plus design</li> <li>• in Shimano eurohole box</li> </ul> <p><b>Cassette sprocket</b> CS-LG700-11150</p> <ul style="list-style-type: none"> <li>• 11-50 teeth</li> <li>• in Shimano eurohole box</li> </ul> <p><b>Shift lever</b> SL-M8130-R</p> <ul style="list-style-type: none"> <li>• right</li> <li>• in Shimano box</li> </ul>	      
<p><b>588555</b> 50 <b>NEW</b></p> <p><b>587857</b> 20 <b>NEW</b></p> <p><b>587854</b> 20 <b>NEW</b></p> <p><b>586266</b> 50 <b>NEW</b></p> <p><b>586445</b> 10 set <b>NEW</b></p>	<p><b>SHIMANO CUES LG (LINK GLIDE) 11-Gang</b></p> <p><b>Schaltwerk</b> RD-U6000</p> <ul style="list-style-type: none"> <li>• Top-Normal</li> <li>• Montageverpackung</li> </ul> <p><b>Kassetten-Zahnkranz</b> CS-LG400-11</p> <ul style="list-style-type: none"> <li>• 11-45 Zähne</li> <li>• Montageverpackung</li> </ul> <p><b>Kassetten-Zahnkranz</b> CS-LG400-11</p> <ul style="list-style-type: none"> <li>• 11-50 Zähne</li> <li>• Montageverpackung</li> </ul> <p><b>Schalthebel</b>, SL-U6000-11R</p> <ul style="list-style-type: none"> <li>• rechts</li> <li>• Montageverpackung</li> </ul> <p><b>Kettenradgarnitur</b> FC-U6000-1EXA2</p> <ul style="list-style-type: none"> <li>• 32 Zähne</li> <li>• 175 mm</li> <li>• Montageverpackung</li> </ul>	<p><b>SHIMANO CUES LG (LINK GLIDE) 11 speed</b></p> <p><b>Rear derailleur</b> RD-U6000</p> <ul style="list-style-type: none"> <li>• top normal</li> <li>• OEM</li> </ul> <p><b>Cassette sprocket</b> CS-LG400-11</p> <ul style="list-style-type: none"> <li>• 11-45 teeth</li> <li>• OEM</li> </ul> <p><b>Cassette sprocket</b> CS-LG400-11</p> <ul style="list-style-type: none"> <li>• 11-50 teeth</li> <li>• OEM</li> </ul> <p><b>Shift lever</b>, SL-U6000-11R</p> <ul style="list-style-type: none"> <li>• right</li> <li>• OEM</li> </ul> <p><b>Chainwheel set</b> FC-U6000-1EXA2</p> <ul style="list-style-type: none"> <li>• 32 teeth</li> <li>• 175 mm</li> <li>• OEM</li> </ul>	    













ART.-NR.	BESCHREIBUNG	DESCRIPTION	
<b>587849</b> 25	<b>SHIMANO CUES (DEORE) LG (LINK GLIDE) 10-Gang</b>  <b>Schaltwerk RD-M5130 GS</b> <ul style="list-style-type: none"> <li>• Top-Normal</li> <li>• Shadow Plus Design</li> <li>• im Shimano Einzelkarton</li> </ul>	<b>SHIMANO CUES (DEORE) LG (LINK GLIDE) 10 speed</b>  <b>Rear derailleur RD-M5130 GS</b> <ul style="list-style-type: none"> <li>• top normal</li> <li>• shadow plus design</li> <li>• in Shimano box</li> </ul>	
<b>587858</b> 20 <b>NEW</b>	<b>Kassetten-Zahnkranz CS-LG300-10</b> <ul style="list-style-type: none"> <li>• 11-39 Zähne</li> <li>• Montageverpackung</li> </ul>	<b>Cassette sprocket CS-LG300-10</b> <ul style="list-style-type: none"> <li>• 11-39 teeth</li> <li>• OEM</li> </ul>	
<b>587853</b> 12 <b>NEW</b>	<b>Kassetten-Zahnkranz CS-LG400-10</b> <ul style="list-style-type: none"> <li>• 11-43 Zähne</li> <li>• in Shimano Eurolochbox</li> </ul>	<b>Cassette sprocket CS-LG400-10</b> <ul style="list-style-type: none"> <li>• 11-43 teeth</li> <li>• in Shimano eurohole box</li> </ul>	
<b>587859</b> 20 <b>NEW</b>	<b>Kassetten-Zahnkranz CS-LG300-10</b> <ul style="list-style-type: none"> <li>• 11-48 Zähne</li> <li>• Montageverpackung</li> </ul>	<b>Cassette sprocket CS-LG300-10</b> <ul style="list-style-type: none"> <li>• 11-48 teeth</li> <li>• OEM</li> </ul>	
<b>587851</b> 10	<b>Schalthebel SL-M5130-R</b> <ul style="list-style-type: none"> <li>• rechts</li> <li>• im Shimano Einzelkarton</li> </ul>	<b>Shift lever SL-M5130-R</b> <ul style="list-style-type: none"> <li>• right</li> <li>• in Shimano box</li> </ul>	
<b>588538</b> 25 <b>NEW</b>	<b>Kettenradgarnitur FC-U4000-2</b> <ul style="list-style-type: none"> <li>• 22/36 Zähne</li> <li>• 175 mm Aluminium-Kurbel</li> <li>• Montageverpackung</li> </ul>	<b>Chainwheel set FC-U4000-2</b> <ul style="list-style-type: none"> <li>• 22/36 teeth</li> <li>• 175 mm aluminium crank</li> <li>• OEM</li> </ul>	
<b>588554</b> 25 <b>NEW</b>	<b>SHIMANO DEORE (HG) 10-Gang</b>  <b>Schaltwerk RD-M6000</b> <ul style="list-style-type: none"> <li>• Top-Normal</li> <li>• in Shimano Eurolochbox</li> </ul> <b>Kassetten-Zahnkranz</b> <b>587668</b> CS-HG500-10 <ul style="list-style-type: none"> <li>• 11-34 Zähne</li> <li>• in Shimano Eurolochbox</li> </ul> <b>586279</b> CS-HG50-10 <ul style="list-style-type: none"> <li>• 11-36 Zähne</li> <li>• Montageverpackung</li> </ul> <b>587842</b> CS-M4100-10 <ul style="list-style-type: none"> <li>• 11-42 Zähne</li> <li>• in Shimano Eurolochbox</li> </ul>	<b>SHIMANO DEORE (HG) 10 speed</b>  <b>Rear derailleur RD-M6000</b> <ul style="list-style-type: none"> <li>• top normal</li> <li>• in Shimano eurohole box</li> </ul> <b>Cassette sprocket</b> <b>587668</b> CS-HG500-10 <ul style="list-style-type: none"> <li>• 11-34 teeth</li> <li>• in Shimano eurohole box</li> </ul> <b>586279</b> CS-HG50-10 <ul style="list-style-type: none"> <li>• 11-36 teeth</li> <li>• OEM</li> </ul> <b>587842</b> CS-M4100-10 <ul style="list-style-type: none"> <li>• 11-42 teeth</li> <li>• in Shimano eurohole box</li> </ul>	
<b>586262</b> links	<b>Schalthebel SL-M6000</b> in Shimano Eurolochbox	<b>Shift lever SL-M6000</b> in Shimano eurohole box	
<b>586263</b> rechts	<b>Schalthebel SL-M6000</b> in Shimano Eurolochbox	<b>Shift lever SL-M6000</b> in Shimano eurohole box	

ART.-NR. 	BESCHREIBUNG	DESCRIPTION	
	<p><b>Scheibenbremse</b> BR-MT420 und Bremshebel BL-M4100, (ohne IS-Adapter), durch <b>J-Kit individuell kürzbar</b> und <b>schneller montierbar</b>, in Shimano Eurolochbox</p>	<p><b>Disc brake</b> BR-MT420 and brake lever BL-M4100, (w/o IS-adapter), can be <b>individually shortened</b> and <b>assembled more quickly</b> using the <b>J-Kit</b>, in Shimano eurohole box</p>	  
<b>587833</b>	vorne, Hydraulikleitung 1.000 mm	front, hydraulic tube 1,000 mm	
<b>587834</b> 10 set	hinten, Hydraulikleitung 1.700 mm	back, hydraulic tube 1,700 mm	
	<p><b>Bremsscheibe</b> SM-RT64</p> <ul style="list-style-type: none"> <li>• Center Lock</li> <li>• für Sinter- und organische Bremsbeläge, aufgeraut</li> </ul> <p>160 mm</p>	<p><b>Brake disc</b> SM-RT64</p> <ul style="list-style-type: none"> <li>• Center Lock</li> <li>• for sintered and organic brake pads, roughened</li> </ul> <p>160 mm</p>	
<b>587826</b>	in Shimano Eurolochbox	in Shimano eurohole box	
<b>587864</b>	Montageverpackung	OEM	
<b>NEW</b>			
	180 mm	180 mm	
<b>587827</b>	in Shimano Eurolochbox	in Shimano eurohole box	
<b>587865</b>	Montageverpackung	OEM	
<b>NEW</b>			
<b>587813</b> 50	<p><b>Innenlager</b> SM-BB52B</p> <ul style="list-style-type: none"> <li>• Hollowtech 2</li> <li>• Montageverpackung</li> </ul>	<p><b>B.B. set</b> SM-BB52B</p> <ul style="list-style-type: none"> <li>• Hollowtech 2</li> <li>• OEM</li> </ul>	
<p><b>SHIMANO CUES LG (LINK GLIDE) 9-Gang</b></p> <p><b>588556</b> <b>Schaltwerk</b> RD-U3020</p> <ul style="list-style-type: none"> <li>• Top-Normal</li> <li>• Montageverpackung</li> </ul> <p><b>NEW</b> 40</p> <p><b>NEW</b></p> <p><b>Kassetten-Zahnkranz</b> CS-LG300-9 Montageverpackung</p> <p><b>587860</b> 11-36 Zähne</p> <p><b>587861</b> 11-41 Zähne</p> <p><b>587862</b> 11-46 Zähne</p> <p>25</p> <p><b>NEW</b></p> <p><b>Schalthebel</b> Montageverpackung</p> <p><b>586268</b> links, SL-U4000-L</p> <p><b>586267</b> rechts, SL-U4000-9R</p> <p>50</p>	<p><b>SHIMANO CUES LG (LINK GLIDE) 9 speed</b></p> <p><b>Rear derailleur</b> RD-U3020</p> <ul style="list-style-type: none"> <li>• top normal</li> <li>• OEM</li> </ul> <p><b>Cassette sprocket</b> CS-LG300-9 OEM</p> <p>11-36 teeth</p> <p>11-41 teeth</p> <p>11-46 teeth</p> <p><b>Shift lever</b> OEM</p> <p>left, SL-U4000-L</p> <p>right, SL-U4000-9R</p>	   	



ART.-NR.	BESCHREIBUNG	DESCRIPTION	
	<b>SHIMANO ALIVIO, ALTUS (HG) 9-Gang</b>	<b>SHIMANO ALIVIO, ALTUS (HG) 9 speed</b>	
<b>588543</b> 20	<b>Schaltwerk RD-M3100 SGS</b> • Top-Normal • Montageverpackung	<b>Rear derailleur RD-M3100 SGS</b> • top normal • OEM	
<b>588548</b> 50	<b>Schaltwerk RD-M370-L SGS</b> • Top-Normal • Montageverpackung	<b>Rear derailleur RD-M370-L SGS</b> • top normal • OEM	
<b>588561</b> 25 <b>NEW</b>	<b>Umwerfer FD-M370</b> • Top Swing • <b>dual pull</b> (für top und down pull) mit Klemme für Ø 34,9 mm Sattelrohr und Adapter für Ø 28,6 mm und 31,8 mm • Kapazität 22 Zähne, für 44 - 48 Zähne • in Shimano Eurolochbox	<b>Front derailleur FD-M370</b> • top swing • <b>dual pull</b> (for top and down pull) with clamp for seat tube Ø 34.9 mm and adapter for Ø 28.6 mm and 31.8 mm • capacity 22 teeth, for 44 - 48 teeth • in Shimano eurohole box	
<b>586276</b>	<b>Kassetten-Zahnkranz CS-HG400-9</b> Montageverpackung 11-32 Zähne	<b>Cassette sprocket CS-HG400-9</b> OEM 11-32 teeth	
<b>586273</b> 50	11-34 Zähne	11-34 teeth	
<b>586406</b>	<b>Kassetten-Zahnkranz CS-HG200-9</b> Montageverpackung 11-32 Zähne	<b>Cassette sprocket CS-HG200-9</b> OEM 11-32 teeth	
<b>586407</b> 50	11-34 Zähne	11-34 teeth	
<b>586260</b>	<b>Schalthebel</b> Montageverpackung links, SL-M3100-L	<b>Shift lever</b> OEM left, SL-M3100-L	
<b>586261</b> 50	rechts, SL-M3100-R	right, SL-M3100-R	
<b>588505</b>	<b>V-Bremse BR-T4000</b> Montageverpackung vorne	<b>V-brake BR-T4000</b> OEM front	
<b>587810</b> 50	hinten	rear	
<b>587824</b>	<b>Scheibenbremse BR-MT200 und Bremshebel BL-MT200, mit Hydraulikleitung</b> (ohne IS-Adapter) Montageverpackung vorne, Leitung 1.000 mm	<b>Disc brake BR-MT200 and brake lever BL-MT200, with hydraulic tube</b> (w/o IS-adapter) OEM front, cable 1,000 mm	
<b>587825</b> 25 set	hinten, Leitung 1.700 mm	rear, cable 1,700 mm	
<b>587870</b> 50 set <b>NEW</b>	<b>Scheibenbremse BR-TX805</b> • für <b>vorne oder hinten</b> • Montageverpackung	<b>Disc brake BR-TX805</b> • for <b>front or rear</b> • OEM	
<b>587835</b>	<b>Bremsscheibe SM-RT10</b> • Center Lock • für Resin Bremsbeläge • Montageverpackung 160 mm	<b>Brake disc SM-RT10</b> • center lock • for resin pads • OEM 160 mm	
<b>587836</b> 50	180 mm	180 mm	



ART.-NR.	BESCHREIBUNG	DESCRIPTION	
	<b>SHIMANO ALTUS (HG) 8-Gang</b>	<b>SHIMANO ALTUS (HG) 8 speed</b>	
	<b>Schaltwerk</b> • für 8- und 7 Gang • Montageverpackung	<b>Rear derailleur</b> • for 8- und 7 speed • OEM	
<b>586456</b> 50	RD-M310-L	RD-M310-L	
<b>588549</b> 60	RD-TX800	RD-TX800	
<b>588539</b> 100	<b>Umwerfer FD-TY601-L6</b> • Top Swing • <b>dual pull</b> (für top und down pull) • Schelle passend für Ø 31,8 und 34,9 mm • passend für (42-) 48 Zähne • Montageverpackung	<b>Front derailleur FD-TY601-L6</b> • top swing • <b>dual pull</b> (for top and down pull) • for clamp Ø 31.8 and 34.9 mm • usable for (42-) 48 teeth • OEM	
<b>NEW</b>			
<b>586277</b> 50	<b>Kassetten-Zahnkranz CS-HG41-8</b> • 11-32 Zähne • silber • Montageverpackung	<b>Cassette sprocket CS-HG41-8</b> • 11-32 teeth • silver • OEM	
<b>586274</b> 50	<b>Kassetten-Zahnkranz CS-HG31-8</b> • 11-32 Zähne • schwarz • Montageverpackung	<b>Cassette sprocket CS-HG31-8</b> • 11-32 teeth • black • OEM	
<b>586269</b>	<b>Kassetten-Zahnkranz CS-HG200-8</b> • 12-32 Zähne • schwarz • Montageverpackung	<b>Cassette sprocket CS-HG200-8</b> • 12-32 teeth • black • OEM	
<b>586281</b> AD 50	wie Art. 586269, aber für Anti-Dumping Befreite	like art. 586269, but for anti-dumping exempt	
	<b>Schalthebel</b> Montageverpackung	<b>Shift lever</b> OEM	
<b>586250</b>	links, SL-M315-L	left, SL-M315-L	
<b>586251</b> 50	rechts, SL-M315-8R	right, SL-M315-8R	
	<b>Schalt-/Bremshebel</b> Montageverpackung	<b>Shift/brake lever</b> OEM	
<b>586257</b>	links, ST-EF500-L	left, ST-EF500-L	
<b>586208</b> 50	rechts, ST-EF500-8R	right, ST-EF500-8R	
<b>NEW</b>			
	<b>Schalthebel</b> Montageverpackung	<b>Shift lever</b> OEM	
<b>586264</b>	links, 3-fach, SLRV400LNB	left, 3 speed, SLRV400LNB	
<b>586265</b> 50	rechts, 8-fach, SLRV4008RA	right, 8 speed, SLRV4008RA	
	<b>Schalthebel</b> Montageverpackung	<b>Shift lever</b> OEM	
<b>587807</b>	links, SL-RS45-L	left, SL-RS45-L	
<b>587814</b> 100	rechts, SL-RS45-8R	right, SL-RS45-8R	
<b>586430</b> 20 set	<b>Kettenradgarnitur FC-TY501</b> • 24/34/42 Zähne • 170 mm Aluminium-Kurbel • für 4-Kant-Innenlager • Montageverpackung	<b>Chainwheel set FC-TY501</b> • 24/34/42 teeth • 170 mm aluminium crank • for square B.B. set • OEM	

ART.-NR.	BESCHREIBUNG	DESCRIPTION	
<ul style="list-style-type: none"> <li>• <b>588547</b> ohne Halter 60</li> <li>• <b>588544</b> mit Halter 60</li> </ul>	<p><b>SHIMANO TOURNEY TY (3x) 7-Gang Index</b></p> <p><b>Schaltwerk RD-TY300</b> Montageverpackung</p>	<p><b>SHIMANO TOURNEY TY (3x) 7 speed Index</b></p> <p><b>Rear derailleur RD-TY300</b> OEM</p> <p>without bracket</p> <p>with bracket</p>	
<p><b>588539</b> 100</p> <p><b>NEW</b></p>	<p><b>Umwerfer FD-TY601-L6</b></p> <ul style="list-style-type: none"> <li>• Top Swing</li> <li>• <b>dual pull</b> (für top und down pull)</li> <li>• Schelle passend für Ø 31,8 und 34,9 mm</li> <li>• passend für (42-) 48 Zähne</li> <li>• Montageverpackung</li> </ul>	<p><b>Front derailleur FD-TY601-L6</b></p> <ul style="list-style-type: none"> <li>• top swing</li> <li>• <b>dual pull</b> (for top and down pull)</li> <li>• for clamp Ø 31.8 and 34.9 mm</li> <li>• usable for (42-) 48 teeth</li> <li>• OEM</li> </ul>	
<p><b>586275</b> 50</p>	<p><b>Kassetten-Zahnkranz CS-HG41-7</b></p> <ul style="list-style-type: none"> <li>• 11-28 Zähne</li> <li>• silber</li> <li>• Montageverpackung</li> </ul>	<p><b>Cassette sprocket CS-HG41-7</b></p> <ul style="list-style-type: none"> <li>• 11-28 teeth</li> <li>• silver</li> <li>• OEM</li> </ul>	
<p><b>586270</b> 50</p>	<p><b>Kassetten-Zahnkranz CS-HG200-7</b></p> <ul style="list-style-type: none"> <li>• 12-28 Zähne</li> <li>• schwarz</li> <li>• Montageverpackung</li> </ul>	<p><b>Cassette sprocket CS-HG200-7</b></p> <ul style="list-style-type: none"> <li>• 12-28 teeth</li> <li>• black</li> <li>• OEM</li> </ul>	
<p>• <b>587632</b> AD 50</p>	<p>wie Art. 586270, aber für Anti-Dumping Befreite</p>	<p>like art. 586270, but for anti-dumping exempt</p>	
<p><b>586272</b></p>	<p><b>Freilaufzahnkranz MF-TZ500</b></p> <ul style="list-style-type: none"> <li>• 14-28 Zähne</li> <li>• Index</li> <li>• braun/schwarz</li> <li>• Montageverpackung</li> </ul>	<p><b>Freewheel MF-TZ500</b></p> <ul style="list-style-type: none"> <li>• 14-28 teeth</li> <li>• Index</li> <li>• brown/black</li> <li>• OEM</li> </ul>	
<p>• <b>586416</b> AD 40</p>	<p>wie Art. 586272, aber für Anti-Dumping Befreite</p>	<p>like art. 586272, but for anti-dumping exempt</p>	
<p><b>586257</b></p>	<p><b>Schalthebel</b> Montageverpackung</p> <p>links, ST-EF500-L</p>	<p><b>Shift lever</b> OEM</p> <p>left, ST-EF500-L</p>	
<p><b>586259</b> 50</p>	<p>rechts, ST-EF500-7R</p>	<p>right, ST-EF500-7R</p>	
<p><b>587234</b></p>	<p><b>Schalthebel</b> Montageverpackung</p> <p>links, ST-EF500-L</p>	<p><b>Shift lever</b> OEM</p> <p>links, ST-EF500-L</p>	
<p><b>587235</b> 50</p>	<p>rechts, ST-EF500-7R</p>	<p>rechts, ST-EF500-7R</p>	
<p><b>586213</b></p>	<p><b>Schalthebel</b> Montageverpackung</p> <p>links, SL-RV200-L</p>	<p><b>Shift lever</b> OEM</p> <p>left, SL-RV200-L</p>	
<p><b>586212</b> 100</p>	<p>rechts, SL-RV200-7R</p>	<p>right, SL-RV200-7R</p>	
<p>• <b>586438</b> 20 set</p>	<p><b>Kettenradgarnitur FC-TY301</b></p> <ul style="list-style-type: none"> <li>• 170 mm Aluminium-Kurbel</li> <li>• mit Kettenschutz</li> <li>• AL = 119</li> <li>• Montageverpackung</li> </ul>	<p><b>Chainwheel set FC-TY301</b></p> <ul style="list-style-type: none"> <li>• 170 mm aluminium crank</li> <li>• with chainguard</li> <li>• AL = 119</li> <li>• OEM</li> </ul>	
<p>• <b>586439</b> 20 set</p>	<p>28/38/48 Zähne</p> <p>24/34/42 Zähne</p>	<p>28/38/48 teeth</p> <p>24/34/42 teeth</p>	

ART.-NR. 	BESCHREIBUNG	DESCRIPTION	
	<b>SHIMANO-TY (3x) 6-Gang Index</b>	<b>SHIMANO-TY (3x) 6 speed Index</b>	 
	<b>Schaltwerk</b>	<b>Rear derailleur</b>	
• <b>586937</b> 40	RD-TZ500 • ohne Halter • Montageverpackung	RD-TZ500 • without bracket • OEM	
• <b>586415</b> AD 40	wie Art. 586937, aber für Anti-Dumping Befreite	like art. 586937, but for anti-dumping exempt	
<b>586938</b> 40	RD-TZ500 • mit Halter • Montageverpackung	RD-TZ500 • with bracket • OEM	
• <b>586457</b> AD 40	wie Art. 586938, aber für Anti-Dumping Befreite	like art. 586938, but for anti-dumping exempt	
<b>586271</b> 50	<b>Freilaufzahnkranz MF-TZ500</b> • 14-28 Zähne • Index • braun/schwarz • Montageverpackung	<b>Freewheel MF-TZ500</b> • 14-28 teeth • Index • brown/black • OEM	
• <b>586400</b> AD 50	wie Art. 586271, aber für Anti-Dumping Befreite	like art. 586271, but for anti-dumping exempt	
	<b>Schalt-/Bremshebel ST-EF41</b> Montageverpackung	<b>Shift/brake lever ST-EF41</b> OEM	
<b>587742</b>	links	left	
<b>587821</b> 50	rechts, 6-fach	right, 6 speed	
	<b>Schalthebel SL-RV200</b> Montageverpackung	<b>Shift lever SL-RV200</b> OEM	
• <b>586217</b> 100	links, 3-fach Friction	left, 3 speed friction	
• <b>586211</b> 150	rechts, 6-fach SIS	right, 6 speed SIS	

## NON GROUP

## NON GROUP

	<b>SHIMANO KOMponenten GRUPPENFREI</b>	<b>SHIMANO COMPONENTS FREE OF GROUPS</b>	
<b>587693</b> 20 pair	<b>MTB PEDAL ›PD-M520L‹</b> • CrMo Achse • Auslösehärte einstellbar • gedichtetes Kompaktlager • nur 380 g/Paar • in Shimano Eurolochbox	<b>MTB PEDAL ›PD-M520L‹</b> • CrMo axle • adjustable release tension • sealed compact bearing • only 380 g/pair • in Shimano eurohole box	 
<b>587839</b> 20 pair	<b>KLICKPEDAL ›PD-RS 500‹</b> • mit Schuhplattenset • leichter Ein- und Ausstieg • Auslösehärte einstellbar • gedichtetes Kompaktlager • nur 320 g/Paar • in Shimano Eurolochbox	<b>CLIPLESS PEDAL ›PD-RS 500‹</b> • with cleat set • easy click-in and click-out • adjustable release tension • sealed compact bearing • only 320 g/pair • in Shimano eurohole box	 



ART.-NR.	BESCHREIBUNG	DESCRIPTION	
<b>NON GROUP</b>		<b>NON GROUP</b>	
<b>588326</b> <b>NEW</b> 50	<b>Innenlager</b> BB-MT501 • Hollowtech 2 • für 68 / 73 mm Gehäusebreite • Montageverpackung	<b>B.B. set</b> BB-MT501 • Hollowtech 2 • for 68 / 73 mm shell width • OEM	
<b>588505</b>	<b>V-Bremsen</b> BR-T4000 Montageverpackung vorne	<b>V-brake</b> BR-T4000 OEM front	
<b>587810</b> 50	hinten	rear	
<b>587833</b>	<b>Scheibenbremse</b> BR-MT420 und Bremshebel BL-M4100, (ohne IS-Adapter), <b>J-Kit individuell kürzbar</b> , in Shimano Eurolochbox vorne, Hydraulikleitung 1.000 mm	<b>Disc brake</b> BR-MT420 and brake lever BL-M4100, (w/o IS-adapter), <b>J-kit can individually be shortened</b> , in Shimano eurohole box front, hydraulic tube 1,000 mm	
<b>587834</b> 10	hinten, Hydraulikleitung 1.700 mm	rear, hydraulic tube 1,700 mm	
<b>587824</b>	<b>Scheibenbremse</b> BR-MT200 und Bremshebel BL-MT200, mit <b>Hydraulikleitung</b> (ohne IS-Adapter) vorne, Leitung 1.000 mm	<b>Disc brake</b> BR-MT200 and brake lever BL-MT200, with <b>hydraulic tube</b> (w/o IS-adapter) front, cable 1,000 mm	
<b>587825</b> 25 set	hinten, Leitung 1.700 mm	rear, cable 1,700 mm	
<b>587870</b> 50 set	<b>Scheibenbremse</b> BR-TX805 • für <b>vorne oder hinten</b> • Montageverpackung	<b>Disc brake</b> BR-TX805 • for <b>front and rear</b> • OEM	
<b>587826</b>	<b>Bremsscheibe</b> SM-RT64 • Center Lock • für Sinter- und organische Bremsbeläge, aufgeraut 160 mm in Shimano Eurolochbox	<b>Brake disc</b> SM-RT64 • Center Lock • for sintered and organic brake pads, roughened 160 mm in Shimano eurohole box	
<b>587864</b> <b>NEW</b>	Montageverpackung	OEM	
<b>587827</b>	180 mm in Shimano Eurolochbox	180 mm in Shimano eurohole box	
<b>587865</b> <b>NEW</b> 40	Montageverpackung	OEM	
<b>587835</b>	<b>Bremsscheibe</b> SM-RT10 • Center Lock • für Resin Bremsbeläge • Montageverpackung 160 mm	<b>Brake disc</b> SM-RT10 • center Lock • for resin pads • OEM 160 mm	
<b>587836</b> 50	180 mm	180 mm	



# microSHIFT

## THE BEST CONTROL SYSTEM

1999 gegründet, ist Mircoshift eine noch relativ junge Marke unter den Herstellern von Schaltsystemen. Gleichwohl kann der asiatische Hersteller eine breite und insbesondere qualitativ hochwertige Produktpalette anbieten. Das konsequente Wachstum und die jüngsten Produktentwicklungen sprechen klar für die Marke Microshift als **die** Alternative.

Founded in 1999, Mircoshift is still a relatively young brand among manufacturers of shifting systems. Nevertheless, the Asian manufacturer can provide a broad and in particular qualitative high quality product range. The stringent growth and recent product developments clearly speak in favour of the Microshift brand as **the** alternative.

ADVENT X



### High End ohne Stress - ADVENT X











Wenn Sie High End in der Funktion suchen, aber dabei auf außergewöhnliche neue Standards oder extreme Kosten verzichten möchten, dann sind Sie bei Microshift richtig. Die ADVENT X funktioniert mit normalen Naben und Ketten, hat eine Wide Range Kassette und dank Active Motion und Clutch System im Schaltwerk ein präzises Schaltverhalten. Dabei liegt sie im Gruppengewicht auch noch deutlich unter den Mitbewerbern - und das zu einem mehr als attraktiven Preis!

### High End without the hassle - ADVENT X

If you're looking for high end performance without strange new standards or extremely high pricing, look no further. ADVENT X works with normal hubs and chains, has a wide range cassette and precise shifting thanks to Active Motion and Clutch system in the rear derailleur. And it's even lighter than similar groups from our competitors, but for a more than attractive price!

ART.-NR.	BESCHREIBUNG	DESCRIPTION	
	<b>RENNRAD-GRUPPE MICROSHIFT ›CENTOS11‹</b> 22 (- 33) Gang - Shimano kompatibel	<b>ROAD RACING GROUP MICROSHIFT ›CENTOS11‹</b> 22 (- 33) speed - Shimano compatible	
			194 g
• <b>680113</b> 50	<b>Schaltwerk</b> • <b>schwarz</b> • kurzer Käfig • nur <b>194 g</b> • Kapazität: 35 Zähne • min: 11 Zähne/max: 32 Zähne • Montageverpackung	<b>Rear Derailleur</b> • <b>black</b> • short cage • only <b>194 g</b> • capacity: 35 teeth • min: 11 teeth/max: 32 teeth • OEM	
			UVP 58,90 €
• <b>680114</b> 25	<b>Umwerfer</b> • für 2-fach KRG • downpull • für Anlötteil • nur <b>95 g</b> • Aluminium • Kapazität: 16 Zähne • auch für Kompakt-KRG geeignet • Montageverpackung	<b>Front Derailleur</b> • for 2-speed chainwheel-set • downpull • for boss • only <b>95 g</b> • aluminium • capacity: 16 teeth • also usable for compact chainwheel-set • OEM	95 g 
			UVP 39,90 €
	<b>Schalt-/Bremshebel</b> • Hebel aus <b>geschmiedetem Aluminium</b> • <b>innenliegende Zugverlegung</b> • Shimano kompatibel • Griffweite einstellbar (0-12 mm) • Montageverpackung	<b>Shift/Brake lever</b> • lever made of <b>forged aluminium</b> • <b>for inner cable routing</b> • Shimano compatible • reach adjustable (0-12 mm) • OEM	
<b>680545</b> 50 <b>NEW</b>	• <b>Modell SB-R512B-L</b> • 2-fach • links • nur 265 g	• <b>Model SB-R512B-L</b> • double • left • only 265 g	  UVP 124,00 €
<b>680546</b> 50 <b>NEW</b>	• <b>Modell SB-R512B-R</b> • 11-fach • rechts • nur 259 g	• <b>Model SB-R512B-R</b> • 11-speed • right • only 259 g	  UVP 124,00 €
	<b>Xpress-Schalthebel</b> • Klemme und Hebel aus Aluminium • <b>Industriekugellager</b> • Montageverpackung	<b>Xpress Shifter</b> • aluminium clamp and grip • <b>sealed bearings</b> • OEM	
<b>680550</b> 50 <b>NEW</b>	• <b>Modell SL-R761-2L</b> • 2-fach • links • <b>Trim-Funktion</b> • 165 g	• <b>Model SL-R761-2L</b> • double • left • <b>trim function</b> • 165 g	 UVP 68,90 €
<b>680551</b> 50 <b>NEW</b>	• <b>Modell SL-R761-R</b> • 11-fach • rechts • 171 g	• <b>Model Modell SL-R761-R</b> • 11-speed • right • 171 g	 UVP 68,90 €



ART.-NR.	BESCHREIBUNG	DESCRIPTION	
<p><b>700155</b> 50</p>	<p><b>Kassettenzahnkranz 11-fach</b>                      • <b>Modell CS-H110</b>                      • 11-fach                      • Stahl, verchromt                      • 11 - 28 Zähne                      • 311 g                      • Montageverpackung</p>	<p><b>Cassette Sprocket 11 speed</b>                      • <b>Model CS-H110</b>                      • 11 speed                      • steel, chrome-plated                      • 11 - 28 teeth                      • 311 g                      • OEM</p> <p style="text-align: right;">UVP 44,90 €</p>	  <div style="display: flex; flex-direction: column; align-items: center;"> <div style="border: 1px solid black; border-radius: 50%; padding: 5px; text-align: center; width: 40px; height: 40px; margin-bottom: 5px;"> <b>11</b> Speed                     </div> <div style="border: 1px solid black; padding: 5px; text-align: center; width: 40px; height: 40px;">  311 g                     </div> </div>
<p><b>700417</b> 50 <b>NEW</b></p>	<p><b>Kassettenzahnkranz</b>                      • <b>Modell CS-G110</b>                      • 11-fach                      • <b>Aluminium-Spider und Lockring</b>                      • Stahl, verchromt                      • 11 - 32 Zähne                      • 314 g                      • Montageverpackung</p>	<p><b>Cassette Sprocket</b>                      • <b>Model CS-G110</b>                      • 11 speed                      • <b>aluminium spider and lockring</b>                      • steel, chrome-plated                      • 11 - 32 teeth                      • 314 g                      • OEM</p> <p style="text-align: right;">UVP 76,90 €</p>	 <div style="display: flex; flex-direction: column; align-items: center;"> <div style="border: 1px solid black; padding: 5px; text-align: center; width: 40px; height: 40px;">  314 g                     </div> </div>
	<p><b>RENNRAD-GRUPPE MICROSHIFT ›R10‹</b></p> <ul style="list-style-type: none"> <li>• <b>20 (-30) Gang:</b> Shimano kompatibel</li> <li>• Montageverpackung</li> </ul> <p>• <b>680117</b> Schalt-/Bremshebel 25 pair</p> <ul style="list-style-type: none"> <li>• links + rechts (<b>2 x 10</b> Gang)</li> <li>• für <b>innenliegende Zugverlegung</b></li> <li>• Aluminium-Bremshebel</li> <li>• nur <b>498 g/</b>Paar</li> <li>• mit Klemme 23,8 mm</li> </ul> <p>• <b>680047</b> Schaltwerk 50</p> <ul style="list-style-type: none"> <li>• <b>Aluminium</b></li> <li>• nur <b>218 g</b></li> <li>• Kapazität: 39 Zähne</li> <li>• min: 11 Zähne/max: 28 Zähne</li> </ul> <p>• <b>680442</b> Umwerfer 100</p> <ul style="list-style-type: none"> <li>• <b>geschmiedetes Aluminium</b></li> <li>• für Anlötteil</li> <li>• nur <b>103 g</b></li> <li>• Kapazität: 16 Zähne</li> <li>• größtes Kettenblatt 50 - 56 Zähne</li> <li>• für <b>2-fach</b> KRG</li> </ul> <p><b>Kassettenzahnkranz 10-fach</b></p> <p><b>700152</b> 11 - 25 Zähne</p> <p><b>700153</b> 11 - 28 Zähne 25</p>	<p><b>ROAD RACING GROUP MICROSHIFT ›R10‹</b></p> <ul style="list-style-type: none"> <li>• <b>20 (-30) speed:</b> Shimano compatible</li> <li>• OEM</li> </ul> <p>• <b>Shift/Brake Lever</b></p> <ul style="list-style-type: none"> <li>• left + right (<b>2 x 10</b> speed)</li> <li>• for <b>inner cable routing</b></li> <li>• aluminium brake levers</li> <li>• only <b>498 g/</b>pair</li> <li>• with clamp 23.8 mm</li> </ul> <p style="text-align: right;">UVP 204,00 €</p> <p>• <b>Rear Derailleur</b></p> <ul style="list-style-type: none"> <li>• <b>aluminium</b></li> <li>• only <b>218 g</b></li> <li>• capacity: 39 teeth</li> <li>• min: 11 teeth/max: 28 teeth</li> </ul> <p style="text-align: right;">UVP 53,90 €</p> <p>• <b>Front Derailleur</b></p> <ul style="list-style-type: none"> <li>• <b>forged aluminium</b></li> <li>• for boss</li> <li>• only <b>103 g</b></li> <li>• capacity: 16 teeth</li> <li>• biggest chainwheel 50 - 56 teeth</li> <li>• for <b>2-speed</b> chainwheel set</li> </ul> <p style="text-align: right;">UVP 34,90 €</p> <p><b>Cassette Sprocket 10 speed</b></p> <p><b>700152</b> 11 - 25 teeth</p> <p><b>700153</b> 11 - 28 teeth</p> <p style="text-align: right;">UVP 35,90 €</p>	 <div style="display: flex; flex-direction: column; align-items: center;"> <div style="border: 1px solid black; border-radius: 50%; padding: 5px; text-align: center; width: 40px; height: 40px; margin-bottom: 5px;"> <b>10</b> Speed                     </div> <div style="border: 1px solid black; padding: 5px; text-align: center; width: 40px; height: 40px;">  314 g                     </div> </div> <p style="margin-left: 100px;"><input checked="" type="checkbox"/> inner cable routing</p>   <div style="display: flex; flex-direction: column; align-items: center;"> <div style="border: 1px solid black; padding: 5px; text-align: center; width: 40px; height: 40px;">  274 g                     </div> </div> 

ART.-NR.	BESCHREIBUNG	DESCRIPTION	
	<b>RENNRAD-GRUPPE MICROSHIFT</b> <ul style="list-style-type: none"> <li>• <b>18 (- 27) Gang</b> - Shimano kompatibel</li> <li>• Montageverpackung</li> </ul>	<b>ROAD RACING GROUP MICROSHIFT</b> <ul style="list-style-type: none"> <li>• <b>18 (- 27) speed</b> - Shimano compatible</li> <li>• OEM</li> </ul>	
• <b>680050</b> 50	<b>Schaltwerk</b> <ul style="list-style-type: none"> <li>• 9- und 10-fach</li> <li>• kurzer Käfig</li> <li>• Kapazität: 33 Zähne</li> <li>• min: 11 Zähne/max: 28 Zähne</li> <li>• nur <b>218 g</b></li> </ul>	<b>Rear Derailleur</b> <ul style="list-style-type: none"> <li>• 9 and 10 speed</li> <li>• short cage</li> <li>• capacity: 33 teeth</li> <li>• min: 11 teeth/max: 28 teeth</li> <li>• only <b>218 g</b></li> </ul>	
• <b>680183</b> 100	<b>Umwerfer</b> <ul style="list-style-type: none"> <li>• <b>Aluminium</b>klemme und <b>Aluminium</b>-körper</li> <li>• für 2-fach KRG</li> <li>• downpull</li> <li>• Schelle Ø 34,9 mit Adapter für Ø 31,8 mm</li> <li>• Kapazität: 16 Zähne</li> <li>• größtes Kettenblatt 46 - 52 Zähne</li> <li>• nur <b>125 g</b></li> </ul>	<b>Front Derailleur</b> <ul style="list-style-type: none"> <li>• <b>aluminium</b> clamp and <b>aluminium</b> body</li> <li>• for 2 speed chainwheel set</li> <li>• downpull</li> <li>• clamp Ø 34.9 with adapter for Ø 31.8 mm</li> <li>• capacity: 16 teeth</li> <li>• biggest chainwheel 46 - 52 teeth</li> <li>• only <b>125 g</b></li> </ul>	
• <b>680052</b> 25 pair	<b>Schalt-/Bremshebel</b> <ul style="list-style-type: none"> <li>• rechts und links</li> <li>• mit Klemme Ø 23,8 mm</li> <li>• nur <b>430 g/</b>Paar</li> </ul>	<b>Shift/Brake Lever</b> <ul style="list-style-type: none"> <li>• right and left</li> <li>• with clamp Ø 23.8 mm</li> <li>• only <b>430 g/</b>pair</li> </ul>	
			UVP 49,90 €
			UVP 28,90 €
			UVP 176,00 €

## SCHALTUNGSKOMPONENTEN OFF-ROAD

## SHIFTING COMPONENT OFF-ROAD

	<b>LENKEREND-SCHALTHEBEL</b> <ul style="list-style-type: none"> <li>• <b>12-fach</b></li> <li>• Aluminium</li> <li>• 75 g</li> <li>• Index / Microindex umschaltbar</li> <li>• Montageverpackung</li> </ul>	<b>BAR END SHIFTER</b> <ul style="list-style-type: none"> <li>• <b>12 speed</b></li> <li>• aluminium</li> <li>• 75 g</li> <li>• index / microindex switchable</li> <li>• OEM</li> </ul>	
<b>680493</b>	<b>Modell BS-SR-M12-R</b> Sram MTB 1 x 12-fach kompatibel	<b>Model BS-SR-M12-R</b> Sram MTB 1 x 12 speed compatible	
<b>680496</b> 50	<b>Modell BS-M12-R</b> Shimano 1 x 12-fach kompatibel	<b>Model BS-M12-R</b> Shimano 1 x 12 speed compatible	
			UVP 77,90 €
			UVP 77,90 €

ART.-NR. 	BESCHREIBUNG	DESCRIPTION	
	<p><b>MTB-GRUPPE MICROSHIFT</b></p> <ul style="list-style-type: none"> <li>• <b>11-fach</b>, Shimano kompatibel</li> <li>• Montageverpackung</li> </ul>	<p><b>MTB GROUP MICROSHIFT</b></p> <ul style="list-style-type: none"> <li>• <b>11 speed</b>, Shimano compatible</li> <li>• OEM</li> </ul>	 
<p><b>680443</b> 50</p>	<p><b>Schaltwerk ›XLE 11‹</b></p> <ul style="list-style-type: none"> <li>• mittlerer Käfig</li> <li>• Kapazität: 41 Zähne</li> <li>• min: 11 Zähne/max: 40 Zähne</li> <li>• <b>309 g</b></li> </ul>	<p><b>Rear Derailleur ›XLE 11‹</b></p> <ul style="list-style-type: none"> <li>• medium cage</li> <li>• capacity: 41 teeth</li> <li>• min: 11 teeth/max: 40 teeth</li> <li>• <b>309 g</b></li> </ul> <p>UVP 69,90 €</p>	
<p><b>680142</b> 250</p>	<p><b>Schalthebel</b></p> <ul style="list-style-type: none"> <li>• rechts, <b>Index/Microindex</b> umschaltbar</li> <li>• schwarz, mit <b>CNC-gefrästem Aluminium</b>-Schalthebel</li> <li>• nur <b>64 g</b></li> </ul>	<p><b>Shiftlever</b></p> <ul style="list-style-type: none"> <li>• right, <b>index/microindex</b> switchable</li> <li>• black, with <b>CNC machined aluminium</b> shifting trigger</li> <li>• only <b>64 g</b></li> </ul> <p>UVP 69,90 €</p>	
<p><b>680497</b> 30</p>	<p><b>Lenkerend-Schalthebel</b></p> <ul style="list-style-type: none"> <li>• <b>11-fach</b></li> <li>• Aluminium</li> <li>• 75 g</li> <li>• Index / Microindex umschaltbar</li> </ul>	<p><b>bar end shifter</b></p> <ul style="list-style-type: none"> <li>• <b>11 speed</b></li> <li>• aluminium</li> <li>• 75 g</li> <li>• index / microindex switchable</li> </ul> <p>UVP 69,90 €</p>	 
<p><b>680497</b> 30</p>	<p><b>Modell BS-SR-M11-R</b> Sram MTB 1 x 11-fach kompatibel</p> <ul style="list-style-type: none"> <li>• Montageverpackung</li> </ul>	<p><b>Model BS-SR-M11-R</b> Sram MTB 1 x 11 speed compatible</p> <ul style="list-style-type: none"> <li>• OEM</li> </ul> <p>UVP 69,90 €</p>	
<p><b>680499</b> 30</p>	<p><b>Modell BS-M11-R</b> Shimano 1 x 11-fach kompatibel</p>	<p><b>Model BS-M11-R</b> Shimano 1 x 11 speed compatible</p>	
<p><b>680499</b> 30</p>	<p>Montageverpackung</p>	<p>OEM</p> <p>UVP 69,90 €</p>	
<p><b>680413</b> 30</p>	<p>in Microshift Einzelkarton</p>	<p>in Microshift box</p> <p>UVP 69,90 €</p>	
<p><b>700159</b> 25</p>	<p><b>Kassettenzahnkranz</b></p> <ul style="list-style-type: none"> <li>• <b>11-fach</b></li> <li>• schwarz</li> <li>• 11 - 42 Zähne</li> <li>• 557 g</li> <li>• Montageverpackung</li> </ul>	<p><b>cassette sprocket</b></p> <ul style="list-style-type: none"> <li>• <b>11 speed</b></li> <li>• black</li> <li>• 11 - 42 teeth</li> <li>• 557 g</li> <li>• OEM</li> </ul> <p>UVP 89,90 €</p>	

ART.-NR. 	BESCHREIBUNG	DESCRIPTION	
	<b>MTB-GRUPPE MICROSHIFT</b>	<b>MTB GROUP MICROSHIFT</b>	
	<ul style="list-style-type: none"> <li>• <b>10-fach</b> - Shimano kompatibel</li> <li>• Montageverpackung</li> </ul>	<ul style="list-style-type: none"> <li>• <b>10 speed</b> - Shimano kompatibel</li> <li>• OEM</li> </ul>	
<b>680177</b> 50	<b>Schaltwerk ›XLE‹</b> <ul style="list-style-type: none"> <li>• mattschwarz/silber</li> <li>• <b>Aluminium-Käfig CNC-gefräst</b></li> <li>• Kapazität: 43 Zähne</li> <li>• min: 11 Zähne/max: 36 Zähne</li> <li>• nur <b>281 g</b></li> </ul>	<b>Rear Derailleur ›XLE‹</b> <ul style="list-style-type: none"> <li>• matt black/silver</li> <li>• <b>aluminium cage CNC machined</b></li> <li>• capacity: 43 teeth</li> <li>• min: 11 teeth/max: 36 teeth</li> <li>• only <b>281 g</b></li> </ul> <p style="text-align: right;">UVP 45,90 €</p>	
<b>680147</b> 100	<b>Schalthebel</b> <ul style="list-style-type: none"> <li>• schwarz, mit <b>CNC-gefrästem Aluminium</b>-Schalthebel</li> <li>• rechts</li> <li>• <b>Index/Microindex</b> umschaltbar</li> <li>• nur <b>60 g</b></li> </ul>	<b>Shiftlever</b> <ul style="list-style-type: none"> <li>• black, with <b>CNC-machined aluminium</b> shifting trigger</li> <li>• right</li> <li>• <b>index/microindex</b> switchable</li> <li>• only <b>60 g</b></li> </ul> <p style="text-align: right;">UVP 72,90 €</p>	
	<b>Lenkerend-Schalthebel</b> <ul style="list-style-type: none"> <li>• Aluminium</li> <li>• Shimano 10-fach kompatibel</li> </ul>	<b>bar end shifter</b> <ul style="list-style-type: none"> <li>• aluminium</li> <li>• Shimano 10 speed compatible</li> </ul>	
<b>680414</b> 60 pair	<b>Modell BS-M10</b> <ul style="list-style-type: none"> <li>• links 2/3 Microindex</li> <li>• rechts 10-fach, <b>Index/Microindex</b> umschaltbar</li> <li>• <b>150 g/Pair</b></li> <li>• <b>Paar, rechts und links</b></li> <li>• im Microshift Einzelkarton</li> </ul>	<b>Model BS-M10</b> <ul style="list-style-type: none"> <li>• left 2/3 microindex</li> <li>• right 10 speed, <b>index/microindex</b> switchable</li> <li>• <b>150 g/pair</b></li> <li>• <b>pair, right and left</b></li> <li>• in Microshift box</li> </ul> <p style="text-align: right;">UVP 129,00 €</p>	
<b>680538</b> <b>NEW</b> 30	<b>Modell BS-M10-L</b> <ul style="list-style-type: none"> <li>• links 10-fach, <b>Index/Microindex</b> umschaltbar</li> <li>• 75 g</li> <li>• Montageverpackung</li> </ul>	<b>Model BS-M10-L</b> <ul style="list-style-type: none"> <li>• left 10 speed, <b>index/microindex</b> switchable</li> <li>• 75 g</li> <li>• OEM</li> </ul> <p style="text-align: right;">UVP 67,90 €</p>	
	<b>Modell BS-M10-R</b> <ul style="list-style-type: none"> <li>• rechts 10-fach, <b>Index/Microindex</b> umschaltbar</li> <li>• 75 g</li> </ul>	<b>Model BS-M10-R</b> <ul style="list-style-type: none"> <li>• right 10 speed, <b>index/microindex</b> switchable</li> <li>• 75 g</li> </ul>	
<b>680415</b>	im Microshift Einzelkarton	in Microshift box	UVP 65,90 €
<b>680498</b> <b>NEW</b> 60	Montageverpackung	OEM	UVP 65,90 €
<b>700158</b> 30	<b>Kassettenzahnkranz</b> <ul style="list-style-type: none"> <li>• <b>10-fach</b></li> <li>• silber</li> <li>• 11 - 36 Zähne</li> <li>• 446 g</li> <li>• Montageverpackung</li> </ul>	<b>cassette sprocket</b> <ul style="list-style-type: none"> <li>• <b>10 speed</b></li> <li>• silver</li> <li>• 11 - 36 teeth</li> <li>• 446 g</li> <li>• OEM</li> </ul> <p style="text-align: right;">UVP 43,90 €</p>	
<b>680028</b> 50	<b>SCHALTWERK ›MICROSHIFT‹</b> <ul style="list-style-type: none"> <li>• für <b>7/8/9-fach</b></li> <li>• ohne Halter</li> <li>• langer Käfig</li> <li>• schwarz</li> <li>• Kapazität 45 Zähne</li> <li>• min: 11 Zähne/max: 36 Zähne</li> </ul>	<b>REAR DERAILLEUR ›MICROSHIFT‹</b> <ul style="list-style-type: none"> <li>• for <b>7/8/9 speed</b></li> <li>• without bracket</li> <li>• long cage</li> <li>• black</li> <li>• capacity 45 teeth</li> <li>• min: 11 teeth/max: 36 teeth</li> </ul> <p style="text-align: right;">UVP 17,90 €</p>	
<b>680195</b> 150	<b>DREHGRIF-F-SCHALTER</b> <b>Modell MS29-8</b> <ul style="list-style-type: none"> <li>• <b>8 Gang</b>, Index</li> <li>• rechts</li> <li>• Montageverpackung</li> </ul>	<b>TWIST TYPE SHIFTER</b> <b>Model MS29-8</b> <ul style="list-style-type: none"> <li>• <b>8 speed</b>, index</li> <li>• right side</li> <li>• OEM</li> </ul> <p style="text-align: right;">UVP 7,90 €</p>	
<b>680202</b> 150	<b>Modell MS29-3</b> <ul style="list-style-type: none"> <li>• <b>3 Gang</b>, Index</li> <li>• links</li> <li>• Montageverpackung</li> </ul>	<b>Model MS29-3</b> <ul style="list-style-type: none"> <li>• <b>3 speed</b>, index</li> <li>• left side</li> <li>• OEM</li> </ul> <p style="text-align: right;">UVP 6,90 €</p>	



ART.-NR.	BESCHREIBUNG	DESCRIPTION
----------	--------------	-------------

**MICROSHIFT GRAVEL WIDE RANGE** **MICROSHIFT GRAVEL WIDE RANGE**

	<p><b>MICROSHIFT ›ADVENT X‹ GRAVEL 10 SPEED</b></p> <p><b>Schaltwerk</b></p> <ul style="list-style-type: none"> <li>• mit <b>Active Motion RD+</b> und <b>Clutch System</b></li> <li>• 1 x 10-fach</li> <li>• direct cable pull Design</li> <li>• Kapazität: 41 Zähne</li> <li>• min: 11 Zähne/max: 48 Zähne</li> <li>• Montageverpackung</li> </ul>	<p><b>MICROSHIFT ›ADVENT X‹ GRAVEL 10 SPEED</b></p> <p><b>Rear Derailleur</b></p> <ul style="list-style-type: none"> <li>• with <b>Active Motion RD+</b> and <b>Clutch System</b></li> <li>• 1 x 10 speed</li> <li>• direct cable pull design</li> <li>• capacity: 41 teeth</li> <li>• min: 11 teeth/max: 48 teeth</li> <li>• OEM</li> </ul>
<p><b>680433</b></p> <p><b>NEW</b> 50</p>	<ul style="list-style-type: none"> <li>• <b>Modell RD-M6205AM</b></li> <li>• <b>Aluminiumkäfig</b></li> <li>• 319 g</li> </ul>	<ul style="list-style-type: none"> <li>• <b>Model RD-M6205AM</b></li> <li>• <b>aluminium cage</b></li> <li>• 319 g</li> </ul> <p>UVP 74,90 €</p>
<p><b>680492</b></p> <p><b>NEW</b> 50</p>	<ul style="list-style-type: none"> <li>• <b>Modell RD-M6205GM</b></li> <li>• <b>Stahlkäfig</b></li> <li>• 399 g</li> </ul>	<ul style="list-style-type: none"> <li>• <b>Model RD-M6205GM</b></li> <li>• <b>steel cage</b></li> <li>• 399 g</li> </ul> <p>UVP 69,90 €</p>
<p><b>680547</b></p> <p><b>NEW</b> 50</p>	<p><b>Bremshebel</b></p> <ul style="list-style-type: none"> <li>• <b>Modell SB-M100A-L</b></li> <li>• links</li> <li>• Hebel aus <b>geschmiedetem Aluminium</b></li> <li>• nur 175 g</li> <li>• Montageverpackung</li> </ul>	<p><b>Brake lever</b></p> <ul style="list-style-type: none"> <li>• <b>Model SB-M100A-L</b></li> <li>• left</li> <li>• lever made of <b>forged aluminium</b></li> <li>• only 175 g</li> <li>• OEM</li> </ul> <p>UVP 74,90 €</p>
<p><b>680548</b></p> <p><b>NEW</b> 50</p>	<p><b>Schalt-/Bremshebel</b></p> <ul style="list-style-type: none"> <li>• <b>Modell SB-M100A-R</b></li> <li>• 10-fach</li> <li>• rechts</li> <li>• Hebel aus <b>geschmiedetem Aluminium</b></li> <li>• nur 235 g</li> <li>• Montageverpackung</li> </ul>	<p><b>Shift / brake lever</b></p> <ul style="list-style-type: none"> <li>• <b>Model SB-M100A-R</b></li> <li>• 10 speed</li> <li>• right</li> <li>• lever made of <b>forged aluminium</b></li> <li>• nur 235 g</li> <li>• OEM</li> </ul> <p>UVP 125,00 €</p>
	<p><b>Trail Pro-Schalthebel</b></p> <ul style="list-style-type: none"> <li>• 10-fach</li> <li>• rechts</li> <li>• mit 4 <b>Industriekugellagern</b></li> <li>• Klemme aus Aluminium</li> <li>• Montageverpackung</li> </ul>	<p><b>Trail Pro shifter</b></p> <ul style="list-style-type: none"> <li>• 10 speed</li> <li>• right</li> <li>• with 4 <b>sealed bearings</b></li> <li>• clamp made of aluminium</li> <li>• OEM</li> </ul>
<p><b>680432</b></p> <p><b>NEW</b> 100</p>	<ul style="list-style-type: none"> <li>• <b>Modell SL-M9605-R</b></li> <li>• <b>Non-Slip Einlage</b> aus Silikon</li> <li>• nur 116 g</li> </ul>	<ul style="list-style-type: none"> <li>• <b>Model SL-M9605-R</b></li> <li>• <b>non-slip inlay</b> made of silicone</li> <li>• only 116 g</li> </ul> <p>UVP 29,90 €</p>
<p><b>680539</b></p> <p><b>NEW</b> 100</p>	<ul style="list-style-type: none"> <li>• <b>Modell SL-M9605-ER</b></li> <li>• <b>Single Click</b> (1 Klick = 1 Gang) für eine maximale Lebensdauer des Antriebs, besonders bei E-Bikes</li> <li>• nur 120 g</li> </ul>	<ul style="list-style-type: none"> <li>• <b>Model SL-M9605-ER</b></li> <li>• <b>Single Click</b> (1 click = 1 speed) to maximise the drive's lifespan, especially for e-bikes</li> <li>• only 120 g</li> </ul> <p>UVP 32,90 €</p>
<p><b>680446</b></p> <p><b>NEW</b> 100</p>	<ul style="list-style-type: none"> <li>• <b>Modell SL-M9505</b></li> <li>• ohne <b>Non-Slip</b> Einsatz</li> <li>• nur 116 g</li> </ul>	<ul style="list-style-type: none"> <li>• <b>Model SL-M9505</b></li> <li>• without <b>non-slip</b> inlay</li> <li>• only 116 g</li> </ul> <p>UVP 29,90 €</p>
<p><b>680434</b></p> <p>25</p>	<p><b>Kassettenzahnkranz</b></p> <ul style="list-style-type: none"> <li>• <b>Modell CS-G104</b></li> <li>• 10-fach</li> <li>• <b>Aluminium-Spider</b> (nur bedingt für E-Bikes geeignet)</li> <li>• schwarz</li> <li>• <b>11 - 48 Zähne</b></li> <li>• für Shimano 8-11-fach Freilauf</li> <li>• Montageverpackung</li> </ul>	<p><b>Cassette Sprocket</b></p> <ul style="list-style-type: none"> <li>• <b>Model CS-G104</b></li> <li>• 10 speed</li> <li>• <b>aluminium spider</b> (only suitable to a limited extent for e-bikes)</li> <li>• black</li> <li>• <b>11 - 48 teeth</b></li> <li>• for Shimano 8-11 speed freewheel</li> <li>• OEM</li> </ul> <p>UVP 99,90 €</p>
<p><b>680440</b></p> <p><b>NEW</b> 30</p>	<p><b>Kassettenzahnkranz</b></p> <ul style="list-style-type: none"> <li>• <b>Modell CS-H104</b></li> <li>• 10-fach</li> <li>• <b>Stahl-Spider</b></li> <li>• schwarz</li> <li>• <b>11 - 48 Zähne</b></li> <li>• für Shimano 8-11-fach Freilauf</li> <li>• Montageverpackung</li> </ul>	<p><b>Cassette Sprocket</b></p> <ul style="list-style-type: none"> <li>• <b>Model CS-H104</b></li> <li>• 10 speed</li> <li>• <b>steel spider</b></li> <li>• black</li> <li>• <b>11 - 48 teeth</b></li> <li>• for Shimano 8-11 speed freewheel</li> <li>• OEM</li> </ul> <p>UVP 61,90 €</p>

GRAVEL



ART.-NR. 	BESCHREIBUNG	DESCRIPTION	
	<p><b>MICROSHIFT GRUPPE ›ADVENT‹</b></p> <ul style="list-style-type: none"> <li>• 1 x 9-fach</li> <li>• (nur) Microshift Advent kompatibel</li> </ul> <p><b>Schaltwerk</b></p> <ul style="list-style-type: none"> <li>• <b>Modell RD-M6195M</b></li> <li>• 1 x 9-fach</li> <li>• <b>mittlerer Käfig</b></li> <li>• mit <b>Active Motion RD+</b> und <b>Clutch System</b></li> <li>• direct cable pull Design</li> <li>• Kapazität: 41 Zähne</li> <li>• min: 11 Zähne/max: 46 Zähne</li> <li>• 384 g</li> </ul>	<p><b>MICROSHIFT GROUP ›ADVENT‹</b></p> <ul style="list-style-type: none"> <li>• 1 x 9 speed</li> <li>• Microshift Advent compatible (only)</li> </ul> <p><b>Rear Derailleur</b></p> <ul style="list-style-type: none"> <li>• <b>Model RD-M6195M</b></li> <li>• 1x 9 speed</li> <li>• <b>medium cage</b></li> <li>• with <b>Active Motion RD+</b> and <b>Clutch system</b></li> <li>• direct cable pull design</li> <li>• capacity: 41 teeth</li> <li>• min: 11 teeth/max: 46 teeth</li> <li>• 384 g</li> </ul>	 
680422 32	im Microshift Einzelkarton	in Microshift box	UVP 64,90 €
680444 50 <b>NEW</b>	<p>Montageverpackung</p> <p><b>Schaltwerk</b></p> <ul style="list-style-type: none"> <li>• <b>Modell RD-M6195L</b></li> <li>• 2 x 9-fach</li> <li>• <b>langer Käfig</b></li> <li>• mit <b>Active Motion RD+</b> und <b>Clutch System</b></li> <li>• direct cable pull Design</li> <li>• Kapazität: 47 Zähne</li> </ul>	<p>OEM</p> <p><b>Rear Derailleur</b></p> <ul style="list-style-type: none"> <li>• <b>Model RD-M6195L</b></li> <li>• 2 x 9 speed</li> <li>• <b>long cage</b></li> <li>• with <b>Active Motion RD+</b> and <b>Clutch system</b></li> <li>• direct cable pull design</li> <li>• capacity: 47 teeth</li> </ul>	
680423 32	im Microshift Einzelkarton	in Microshift box	UVP 64,90 €
680495 50 <b>NEW</b>	<p>Montageverpackung</p> <p><b>Schaltwerk</b></p> <ul style="list-style-type: none"> <li>• <b>Modell RD-M619M</b></li> <li>• 1 x 9/8-fach</li> <li>• <b>mittlerer Käfig</b></li> <li>• mit <b>Active Motion RD+</b></li> <li>• direct cable pull Design</li> <li>• Kapazität: 41 Zähne</li> </ul>	<p>OEM</p> <p><b>Rear Derailleur</b></p> <ul style="list-style-type: none"> <li>• <b>Model RD-M619M</b></li> <li>• 1 x 9/8 speed</li> <li>• <b>medium cage</b></li> <li>• with <b>Active Motion RD+</b></li> <li>• direct cable pull design</li> <li>• capacity: 41 teeth</li> </ul>	
680452 32	im Microshift Einzelkarton	in Microshift box	UVP 44,90 €
680435 50 <b>NEW</b>	<p>Montageverpackung</p> <p><b>Schalt-/Bremshebel</b></p> <ul style="list-style-type: none"> <li>• <b>Modell SB-M090</b></li> <li>• geschmiedetes Aluminium</li> <li>• 378 g/Pair</li> <li>• links nur Bremshebel, rechts Schalt-/Bremsgriffkombination</li> </ul>	<p>OEM</p> <p><b>Shift/Brakelever</b></p> <ul style="list-style-type: none"> <li>• <b>Model SB-M090</b></li> <li>• forged aluminium</li> <li>• 378 g/pair</li> <li>• left brake lever only, right shift/brake lever combination</li> </ul>	 
680420 20 pair	im Microshift Einzelkarton	in Microshift box	UVP 176,00 €
680479 50 pair <b>NEW</b>	<p>Montageverpackung</p> <p><b>Lenkerend-Schalthebel</b></p> <ul style="list-style-type: none"> <li>• <b>Modell BS-M19-R</b></li> <li>• Aluminium</li> <li>• rechts <b>Index/Friction</b></li> <li>• 75 g</li> <li>• Index/Microindex umschaltbar</li> <li>• Montageverpackung</li> </ul>	<p>OEM</p> <p><b>bar end shifter</b></p> <ul style="list-style-type: none"> <li>• <b>Model BS-M19-R</b></li> <li>• aluminium</li> <li>• right <b>index/friction</b></li> <li>• 75 g</li> <li>• index/microindex switchable</li> <li>• OEM</li> </ul>	  
680494 50	im Microshift Einzelkarton	in Microshift box	UVP 67,90 €
680419 60 <b>NEW</b>	<p>Montageverpackung</p> <p><b>Xpress-Schalthebel</b></p> <ul style="list-style-type: none"> <li>• <b>Modell SL-M8195-R</b></li> <li>• Klemme aus Aluminium</li> <li>• 116 g</li> </ul>	<p>OEM</p> <p><b>Xpress shifter</b></p> <ul style="list-style-type: none"> <li>• <b>Model SL-M8195-R</b></li> <li>• aluminium clamp</li> <li>• 116 g</li> </ul>	  
680430 100 <b>NEW</b>	im Microshift Einzelkarton	in Microshift box	UVP 31,90 €

ART.-NR.	BESCHREIBUNG	DESCRIPTION	
<p></p> <p><b>680424</b> 23</p> <p><b>680445</b> 30</p> <p><b>680552</b> <b>NEW</b> 35</p> <p><b>680451</b> 23</p> <p><b>680436</b> <b>NEW</b> 30</p>	<p><b>Kassettenzahnkranz</b></p> <ul style="list-style-type: none"> <li>• 9-fach</li> <li>• schwarz eloxiert</li> </ul> <p>• <b>Modell CS-H093A</b></p> <ul style="list-style-type: none"> <li>• Aluminium (nur bedingt für E-Bikes geeignet)</li> <li>• 11 - 42 Zähne</li> </ul> <p>im Microshift Einzelkarton</p> <p>Montageverpackung</p> <p>• <b>Modell CS-H093</b></p> <ul style="list-style-type: none"> <li>• Stahl</li> <li>• 11 - 42 Zähne</li> <li>• Montageverpackung</li> </ul> <p>• <b>Modell CS-H093</b></p> <ul style="list-style-type: none"> <li>• Stahl</li> <li>• 11 - 46 Zähne</li> </ul> <p>im Microshift Einzelkarton</p> <p>Montageverpackung</p>	<p><b>Cassette Sprocket</b></p> <ul style="list-style-type: none"> <li>• 9 speed</li> <li>• black anodised</li> </ul> <p>• <b>Model CS-H093A</b></p> <ul style="list-style-type: none"> <li>• aluminium (only suitable to a limited extent for E-bikes)</li> <li>• 11 - 42 teeth</li> </ul> <p>in Microshift box UVP 54,90 €</p> <p>OEM UVP 54,90 €</p> <p>• <b>Model CS-H093</b></p> <ul style="list-style-type: none"> <li>• steel</li> <li>• 11 - 42 teeth</li> <li>• OEM</li> </ul> <p>UVP 39,90 €</p> <p>• <b>Model CS-H093</b></p> <ul style="list-style-type: none"> <li>• steel</li> <li>• 11 - 46 teeth</li> </ul> <p>in Microshift box UVP 54,90 €</p> <p>OEM UVP 54,90 €</p>	 <p><b>9 Speed</b></p>
<p><b>680556</b> <b>NEW</b> 35</p> <p><b>680508</b> <b>NEW</b> 35</p> <p><b>680557</b> <b>NEW</b> 20</p>	<p><b>MICROSHIFT GRUPPE ›ADVENT SUPER SHORT GROUP◁</b></p> <ul style="list-style-type: none"> <li>• besonders für Kinderräder, Falträder, ... geeignet</li> <li>• 1 x 9-fach</li> <li>• Montageverpackung</li> </ul> <p><b>Schaltwerk</b></p> <ul style="list-style-type: none"> <li>• <b>Modell RD-M6195-S</b></li> <li>• <b>mehr Bodenfreiheit</b> durch spezielle Geometrie und <b>extra kurzen Käfig</b></li> <li>• <b>Clutch System</b></li> <li>• Kapazität: 27 Zähne</li> <li>• direct cable pull Design</li> </ul> <p><b>Schalthebel</b></p> <ul style="list-style-type: none"> <li>• <b>Modell SL-M6290-R</b></li> <li>• <b>kurze Reichweite und leichte Schaltvorgänge</b>, dadurch auch für kleine (Kinder-) Hände geeignet</li> <li>• nur <b>20 mm Schalthebelweg</b></li> <li>• <b>kleineres Gehäuse</b> für flexiblere Montage</li> <li>• bessere <b>Durchgriffsmöglichkeit</b> der Finger beim Bremshebel</li> <li>• <b>15 % weniger Kraft</b> nötig</li> </ul> <p><b>Kassettenzahnkranz</b></p> <ul style="list-style-type: none"> <li>• <b>Modell CS-H093</b></li> <li>• <b>11 - 38 Zähne</b></li> <li>• Stahl</li> <li>• schwarz</li> </ul> <p>Auf Anfrage auch mit 11-36 und 11-34 Zähnen erhältlich.</p>	<p><b>MICROSHIFT GROUP ›ADVENT SUPER SHORT GROUP◁</b></p> <ul style="list-style-type: none"> <li>• especially suitable for children's bikes, folding bikes, ...</li> <li>• 1 x 9 speed</li> <li>• OEM</li> </ul> <p><b>Rear Derailleur</b></p> <ul style="list-style-type: none"> <li>• <b>Model RD-M6195-S</b></li> <li>• <b>more ground clearance</b> thanks to special geometry and <b>extra short cage</b></li> <li>• <b>Clutch System</b></li> <li>• capacity: 27 teeth</li> <li>• direct cable pull design</li> </ul> <p>UVP 59,90 €</p> <p><b>Shift Lever</b></p> <ul style="list-style-type: none"> <li>• <b>Model SL-M6290-R</b></li> <li>• <b>short reach and light shifting action</b>, therefore also suitable for small (children's) hands</li> <li>• only <b>20 mm shift lever travel</b></li> <li>• <b>smaller housing</b> for more flexible mounting</li> <li>• more <b>space to reach through</b> to the brake lever</li> <li>• <b>15 % less force</b> required</li> </ul> <p>UVP 19,90 €</p> <p><b>Cassette Sprocket</b></p> <ul style="list-style-type: none"> <li>• <b>Model CS-H093</b></li> <li>• <b>11 - 38 teeth</b></li> <li>• steel</li> <li>• black</li> </ul> <p>UVP 39,90 €</p> <p>Also available with 11-36 and 11-34 teeth on request.</p>	 <p><b>9 Speed</b></p> <p><b>SUPER SHORT</b></p>

ART.-NR. 	BESCHREIBUNG	DESCRIPTION	
	<b>MICROSHIFT GRUPPE ›ACOLYTE‹</b>	<b>MICROSHIFT GROUP ›ACOLYTE‹</b>	
	<ul style="list-style-type: none"> <li>• 1 x 8-fach</li> <li>• (nur) Microshift Acolyte kompatibel</li> </ul>	<ul style="list-style-type: none"> <li>• 1 x 8 speed</li> <li>• Microshift Acolyte compatible (only)</li> </ul>	
<b>680441</b> 50	<b>Schaltwerk</b> <ul style="list-style-type: none"> <li>• <b>Modell RD-M5185M</b></li> <li>• <b>mittlerer Käfig</b></li> <li>• Kapazität: 41 Zähne</li> <li>• Spring Lock <b>Clutch Design</b></li> <li>• direct cable pull Design</li> <li>• min: 11 Zähne/max: 46 Zähne</li> <li>• 384 g</li> <li>• Montageverpackung</li> </ul>	<b>Rear Derailleur</b> <ul style="list-style-type: none"> <li>• <b>Model RD-M5185M</b></li> <li>• <b>medium cage</b></li> <li>• capacity: 41 teeth</li> <li>• Spring Lock <b>Clutch Design</b></li> <li>• direct cable pull design</li> <li>• min: 11 teeth/max: 46 teeth</li> <li>• 384 g</li> <li>• OEM</li> </ul>	 UVP 46,90 €
<b>680439</b> 100	<b>X-Press-Schalthebel</b> <ul style="list-style-type: none"> <li>• <b>Modell SL-M7180-R</b></li> <li>• Klemme aus Aluminium</li> <li>• 134 g</li> <li>• Montageverpackung</li> </ul>	<b>X-Press shifter</b> <ul style="list-style-type: none"> <li>• <b>Model SL-M7180-R</b></li> <li>• aluminium clamp</li> <li>• 134 g</li> <li>• OEM</li> </ul>	 UVP 21,90 €
<b>680455</b> 23	<b>Kassettenzahnkranz</b> <ul style="list-style-type: none"> <li>• <b>Modell CS-H083</b></li> <li>• 8-fach</li> <li>• schwarz eloxiert</li> </ul>	<b>Cassette Sprocket</b> <ul style="list-style-type: none"> <li>• <b>Model CS-H083</b></li> <li>• 8 speed</li> <li>• black anodised</li> </ul>	 UVP 37,90 €
<b>680437</b> 35	<b>12 - 42 Zähne</b> im Microshift Einzelkarton Montageverpackung	<b>12 - 42 teeth</b> in Microshift box OEM	 UVP 37,90 €
<b>680456</b> 23	<b>12 - 46 Zähne</b> im Microshift Einzelkarton	<b>12 - 46 teeth</b> in Microshift box	 UVP 48,90 €
<b>680438</b> 30 <b>NEW</b>	Montageverpackung	OEM	 UVP 48,90 € 
	<b>MICROSHIFT GRUPPE ›ACOLYTE SUPER SHORT GROUP‹</b>	<b>MICROSHIFT GROUP ›ACOLYTE SUPER SHORT GROUP‹</b>	
	<ul style="list-style-type: none"> <li>• besonders für Kinderräder, Falträder, ... geeignet</li> <li>• 1 x 8-fach</li> <li>• (nur) Microshift Acolyte kompatibel</li> <li>• Montageverpackung</li> </ul>	<ul style="list-style-type: none"> <li>• especially suitable for children's bikes, folding bikes, ...</li> <li>• 1 x 8 speed</li> <li>• Microshift Acolyte compatible (only)</li> <li>• OEM</li> </ul>	
<b>680554</b> 35 <b>NEW</b>	<b>Schaltwerk</b> <ul style="list-style-type: none"> <li>• <b>Modell RD-M5180-S</b></li> <li>• <b>mehr Bodenfreiheit</b> durch spezielle Geometrie und <b>extra kurzen Käfig</b></li> <li>• Kapazität: 27 Zähne</li> <li>• direct cable pull Design</li> </ul>	<b>Rear Derailleur</b> <ul style="list-style-type: none"> <li>• <b>Model RD-M5180-S</b></li> <li>• <b>more ground clearance</b> thanks to special geometry and <b>extra short cage</b></li> <li>• capacity: 27 teeth</li> <li>• direct cable pull design</li> </ul>	 UVP 36,90 € 
<b>680507</b> 35 <b>NEW</b>	<b>Schalthebel</b> <ul style="list-style-type: none"> <li>• <b>Modell SL-M6280-R</b></li> <li>• <b>kurze Reichweite und leichte Schaltvorgänge</b> für besonders kleine (Kinder-) Hände</li> <li>• nur <b>20 mm Schalthebelweg</b></li> <li>• <b>kleineres Gehäuse</b> für flexiblere Montage</li> <li>• bessere <b>Durchgriffsmöglichkeit</b> der Finger beim Bremshebel</li> <li>• <b>15 % weniger Kraft</b> nötig</li> </ul>	<b>Shift Lever</b> <ul style="list-style-type: none"> <li>• <b>Model SL-M6280-R</b></li> <li>• <b>short reach and light shifting action</b> for particularly small (children's) hands</li> <li>• only <b>20 mm shift lever travel</b></li> <li>• <b>smaller housing</b> for more flexible mounting</li> <li>• more <b>space to reach through</b> to the brake lever</li> <li>• <b>15 % less force</b> required</li> </ul>	 UVP 19,90 €
<b>680555</b> 35 <b>NEW</b>	<b>Kassettenzahnkranz</b> <ul style="list-style-type: none"> <li>• <b>Modell CS-H081</b></li> <li>• <b>11 - 34 Zähne</b></li> <li>• Stahl</li> <li>• schwarz</li> </ul>	<b>Cassette Sprocket</b> <ul style="list-style-type: none"> <li>• <b>Model CS-H081</b></li> <li>• <b>11 - 34 teeth</b></li> <li>• steel</li> <li>• black</li> </ul>	 UVP 24,90 €
	Auf Anfrage auch mit 11-38 Zähnen erhältlich.	Also available with 11-38 teeth on request.	



ART.-NR.	BESCHREIBUNG	DESCRIPTION	
<p>• <b>680302</b> AD 50</p>	<p><b>SCHALTWERK</b></p> <ul style="list-style-type: none"> <li>• <b>10-fach</b></li> <li>• schwarz</li> <li>• <b>Aluminiumkörper</b></li> <li>• langer Käfig</li> <li>• Kapazität: 45 Zähne</li> <li>• nur <b>311 g</b></li> <li>• Montageverpackung</li> </ul>	<p><b>REAR DERAILLEUR</b></p> <ul style="list-style-type: none"> <li>• <b>10 speed</b></li> <li>• black</li> <li>• <b>aluminium</b> body</li> <li>• long cage</li> <li>• capacity: 45 teeth</li> <li>• only <b>311 g</b></li> <li>• OEM</li> </ul> <p>UVP 28,90 € UVP mAD 42,90 €</p>	 
<p>• <b>680312</b> AD 50</p>	<p><b>UMWERFER</b></p> <ul style="list-style-type: none"> <li>• <b>10-fach</b></li> <li>• dualpull</li> <li>• <b>Aluminium-/Stahlschelle</b> passend für Ø 34,9 / 31,8 mm</li> <li>• top swing</li> <li>• für 3-fach KRG (max. 42 Zähne, Kapazität: 18 Zähne)</li> <li>• Montageverpackung</li> </ul>	<p><b>FRONT DERAILLEUR</b></p> <ul style="list-style-type: none"> <li>• <b>10 speed</b></li> <li>• dualpull</li> <li>• <b>aluminium/steel</b> clamp for Ø 34.9 / 31.8 mm</li> <li>• top swing</li> <li>• for triple chainwheel set (max. 42 teeth, capacity: 18 teeth)</li> <li>• OEM</li> </ul> <p>UVP 10,90 € UVP mAD 15,90 €</p>	
	<p><b>KASSETTENZAHNKRANZ</b></p> <ul style="list-style-type: none"> <li>• <b>10-fach</b></li> <li>• silber</li> <li>• Shimano kompatibel</li> </ul>	<p><b>CASSETTE SPROCKET</b></p> <ul style="list-style-type: none"> <li>• <b>10 speed</b></li> <li>• silver</li> <li>• Shimano kompatibel</li> </ul>	
<p>• <b>700194</b> AD 50</p>	<p>11 - 36 Zähne</p>	<p>11 - 36 teeth</p> <p>UVP 29,90 € UVP mAD 43,90 €</p>	
<p>• <b>700154</b> AD 30</p>	<p>11 - 42 Zähne</p>	<p>11 - 42 teeth</p> <p>UVP 44,90 € UVP mAD 64,90 €</p>	
	<p><b>SCHALTHEBEL</b></p> <ul style="list-style-type: none"> <li>• schwarz</li> <li>• Index</li> <li>• <b>Aluminium</b>, mit Edelstahlzügen</li> <li>• mit Ganganzeige</li> <li>• Montageverpackung</li> </ul>	<p><b>SHIFT LEVER</b></p> <ul style="list-style-type: none"> <li>• black</li> <li>• index</li> <li>• <b>aluminium</b>, with stainless steel wires</li> <li>• with gear indicator</li> <li>• OEM</li> </ul>	
<p>• <b>689524</b> links, 3-fach</p> <p>• <b>689523</b> rechts, 10-fach</p> <p>100</p>		<p>left, triple</p> <p>right, 10 speed</p> <p>UVP 11,90 €</p> <p>UVP 14,90 €</p>	
<p>• <b>680303</b> AD 50</p>	<p><b>SCHALTWERK</b></p> <ul style="list-style-type: none"> <li>• <b>9/8/7-fach</b></li> <li>• schwarz</li> <li>• <b>Aluminiumkörper</b></li> <li>• langer Käfig</li> <li>• Kapazität: 45 Zähne</li> <li>• Montageverpackung</li> </ul>	<p><b>REAR DERAILLEUR</b></p> <ul style="list-style-type: none"> <li>• <b>9/8/7 speed</b></li> <li>• black</li> <li>• <b>aluminium</b> body</li> <li>• long cage</li> <li>• capacity: 45 teeth</li> <li>• OEM</li> </ul> <p>UVP 14,90 € UVP mAD 21,90 €</p>	 
<p>• <b>680313</b> AD 100</p>	<p><b>UMWERFER</b></p> <ul style="list-style-type: none"> <li>• <b>9/8-fach</b></li> <li>• dualpull</li> <li>• <b>Aluminium-/Stahlschelle</b> passend für Ø 34,9 / 31,8 mm</li> <li>• top swing</li> <li>• für 3-fach KRG (max. 44 Zähne, Kapazität: 22 Zähne)</li> <li>• Montageverpackung</li> </ul>	<p><b>FRONT DERAILLEUR</b></p> <ul style="list-style-type: none"> <li>• <b>9/8 speed</b></li> <li>• dualpull</li> <li>• <b>aluminium/steel</b> clamp for Ø 34.9 / 31.8 mm</li> <li>• top swing</li> <li>• for triple chainwheel set (max. 44 teeth, capacity: 22 teeth)</li> <li>• OEM</li> </ul> <p>UVP 12,90 € UVP mAD 18,90 €</p>	
<p>• <b>700195</b> AD 50</p>	<p><b>KASSETTENZAHNKRANZ</b></p> <ul style="list-style-type: none"> <li>• <b>9-fach</b></li> <li>• 11 - 32 Zähne</li> <li>• silber</li> <li>• Shimano kompatibel</li> </ul>	<p><b>CASSETTE SPROCKET</b></p> <ul style="list-style-type: none"> <li>• <b>9 speed</b></li> <li>• 11 - 32 teeth</li> <li>• silver</li> <li>• Shimano kompatibel</li> </ul> <p>UVP 19,90 € UVP mAD 28,90 €</p>	



ART.-NR. 	BESCHREIBUNG	DESCRIPTION	
	<b>SCHALTHEBEL</b> <ul style="list-style-type: none"> <li>• schwarz</li> <li>• Index</li> <li>• Aluminium, mit Edelstahlzügen</li> <li>• mit <b>Ganganzeige</b></li> </ul>	<b>SHIFT LEVER</b> <ul style="list-style-type: none"> <li>• black</li> <li>• index</li> <li>• aluminium, with stainless steel wires</li> <li>• with <b>gear indicator</b></li> </ul>	
• <b>689524</b>	links, 3-fach	left, triple	UVP 11,90 €
• <b>689526</b>	rechts, 9-fach	right, 9 speed	UVP 15,90 €
• <b>689525</b> 100	rechts, 8-fach	right, 8 speed	UVP 13,90 €
	<b>SCHALTWERK</b>	<b>REAR DERAILLEUR</b>	
• <b>680304</b> AD	für <b>6/7/8-fach</b> <b>langer</b> Käfig, ohne Halter	for <b>6/7/8 speed</b> <b>long</b> cage, without bracket	
• <b>680305</b> AD	für <b>6/7-fach</b> <b>langer</b> Käfig, mit Halter	for <b>6/7 speed</b> <b>long</b> cage, with bracket	
• <b>680306</b> AD 50	für <b>6/7-fach</b> <b>kurzer</b> Käfig, mit Halter	for <b>6/7 speed</b> <b>short</b> cage, with bracket	UVP 5,90 € UVP mAD 8,90 €
• <b>680196</b> AD 50	<b>UMWERFER</b> <ul style="list-style-type: none"> <li>• <b>5-8-fach</b></li> <li>• <b>dual pull</b></li> <li>• Schelle für 28,6 - 31,8 mm</li> <li>• für 3-fach Kettenradgarnitur, <b>42 - 44 Zähne</b></li> </ul>	<b>FRONT DERAILLEUR</b> <ul style="list-style-type: none"> <li>• <b>5-8 speed</b></li> <li>• <b>dual pull</b></li> <li>• clamp for 28.6 - 31.8 mm</li> <li>• for triple chainwheel sets, <b>42 - 44 teeth</b></li> </ul>	 UVP 5,90 € UVP mAD 8,90 €
• <b>680314</b> AD 100	<b>UMWERFER</b> <ul style="list-style-type: none"> <li>• downpull</li> <li>• für Kettenradgarnituren mit großen Kettenblättern <b>46 oder 48 Zähne</b></li> <li>• Schelle 28,6 mm</li> </ul>	<b>FRONT DERAILLEUR</b> <ul style="list-style-type: none"> <li>• downpull</li> <li>• for chainwheel sets with big chainrings <b>46 or 48 teeth</b></li> <li>• clamp 28.6 mm</li> </ul>	 UVP 3,90 € UVP mAD 5,90 €
<b>680095</b> 1.000/100	<b>REDUZIERHÜLSE &gt;2 IN 1&lt;</b> <ul style="list-style-type: none"> <li>• aus festem <b>Polypropylen</b></li> <li>• zur Reduzierung des Innendurchmessers der Umwerferschelle von <b>Ø 31,8 auf Ø 28,6 mm</b> und von <b>Ø 34,9 auf Ø 31,8 mm</b></li> </ul>	<b>REDUCTION BUSHING &gt;2 IN 1&lt;</b> <ul style="list-style-type: none"> <li>• made of strong <b>polypropylene</b></li> <li>• for reducing the inner diameter of the front derailleur clamp from <b>Ø 31.8 to Ø 28.6 mm</b> and from <b>Ø 34.9 to Ø 31.8 mm</b></li> </ul>	
<b>680099</b> 250/50	<b>SHELLE MIT ADAPTER</b> <ul style="list-style-type: none"> <li>• um Umwerfer für Anlötteil, an Sitzrohr ohne Anlötteil befestigen zu können</li> <li>• Schellen <b>Ø 34,9 mm</b> mit <b>Adapter für Ø 31,8 mm</b></li> </ul>	<b>CLAMP WITH ADAPTER</b> <ul style="list-style-type: none"> <li>• to fix front derailleurs for frame bosses at seat tubes without bosses</li> <li>• clamp <b>Ø 34.9 mm</b> with <b>adapter for Ø 31.8 mm</b></li> </ul>	 UVP 11,90 €

ART.-NR.	BESCHREIBUNG	DESCRIPTION	
<b>680190</b> 100	<b>HALTER FÜR DIRECT MOUNT UMWERFER</b> <ul style="list-style-type: none"> <li>Aluminium</li> <li>Ø 34,9 mm</li> <li>für Shimano (XTR/XT/SLX/Deore) und Sram (X0/X9/X7)</li> <li>mit Adapter von Ø 34,9 auf Ø 31,8 mm</li> <li>auch zur Anpassung der Kettenlinie für <b>Fat Tire</b> Bikes geeignet</li> </ul>	<b>BRACKET FOR DIRECT MOUNT FRONT DERAILLEUR</b> <ul style="list-style-type: none"> <li>aluminium</li> <li>Ø 34.9 mm</li> <li>for Shimano (XTR/XT/SLX/Deore) and Sram (X0/X9/X7)</li> <li>with adapter from Ø 34.9 to Ø 31.8 mm</li> <li>also suitable to adjust the chainline of <b>Fat Tire</b> Bikes</li> </ul>	 UVP 13,90 €
<b>680193</b> 2.000/100	<b>FAT TIRE BIKE VERLÄNGERUNGSADAPTER</b> <ul style="list-style-type: none"> <li>für Art. 680190</li> <li>Aluminium</li> <li>28 mm</li> <li>für 120 mm Innenlagergehäuse</li> </ul>	<b>FAT TIRE BIKE EXTENSION ADAPTER</b> <ul style="list-style-type: none"> <li>for art. 680190</li> <li>aluminium</li> <li>28 mm</li> <li>for 120 mm B. B. housing</li> </ul>	 UVP 4,90 €
<b>680280</b> 500	<b>SCHALTWERK-ADAPTER ›ADA RANGE‹</b> <ul style="list-style-type: none"> <li>Aluminium</li> <li><b>ermöglicht die Verwendung von wide-range Kassetten</b> mit großen Ritzeln, ohne dass ein Kettenwechsel mit längerem Käfig nötig ist</li> <li>besonders geeignet zum Umbau auf 1-fach Kettenradgarnitur</li> <li>auf M-Wave Eurolochkarte</li> </ul>	<b>REAR DERAILLEUR ADAPTER ›ADA RANGE‹</b> <ul style="list-style-type: none"> <li>aluminium</li> <li><b>allows the installation of wide-range cassettes</b> with large sprockets, without the need for a chain change with a longer cage</li> <li>especially suitable for conversion to 1 speed chainwheel set</li> <li>on M-Wave eurohole card</li> </ul>	   UVP 9,90 €
<b>680091</b> 500/100	<b>HAKEN FÜR SCHALTWERK</b> mit Schraube und Mutter	<b>HOOK FOR REAR DERAILLEUR</b> with bolt and nut	 UVP 1,90 €
<b>680200</b> 250	<b>SCHALTUNGSSCHUTZ</b> <ul style="list-style-type: none"> <li>Stahl</li> <li>88 mm</li> <li>schwarz</li> </ul>	<b>DERAILLEUR GUARD</b> <ul style="list-style-type: none"> <li>steel</li> <li>88 mm</li> <li>black</li> </ul>	 UVP 1,90 €
<b>680222</b> 1.000	<b>SCHALKETTCHEN</b> <ul style="list-style-type: none"> <li>passend für Dreigangnabe <b>Sram T3</b></li> <li>122 mm lang</li> <li>aus <b>Edelstahl</b></li> <li>(kein original Sram Ersatzteil)</li> </ul>	<b>INDICATOR CHAIN</b> <ul style="list-style-type: none"> <li>for internal gear <b>3-speed hub Sram T3</b></li> <li>size 122 mm long</li> <li>made of <b>stainless steel</b></li> <li>(no original Sram spare part)</li> </ul>	 UVP 3,90 €

ART.-NR. 	BESCHREIBUNG	DESCRIPTION	
<b>680221</b> 250	<b>LENKERSCHALTER</b> passend für Sram Spectro T3 und <b>Torpedo Dreigangnabe</b> (kein original Sram Ersatzteil)	<b>TRIGGER CONTROL LEVER</b> suitable for Sram Spectro T3 and <b>Torpedo 3-speed hub</b> (no original Sram spare part)	 UVP 8,90 €
<b>680195</b> 150	<b>DREHGRIFF-SCHALTER</b> <b>Modell MS29-8</b> • <b>8 Gang</b> , Index • rechts • Montageverpackung	<b>TWIST TYPE SHIFTER</b> <b>Model MS29-8</b> • <b>8 speed</b> , Index • right side • OEM	 UVP 7,90 €
<b>680202</b> 150	<b>Modell MS29-3</b> • <b>3 Gang</b> , Index • links • Montageverpackung	<b>Model MS29-3</b> • <b>3 speed</b> , Index • left side • OEM	 UVP 6,90 €
<b>689601</b> 100 pair	<b>Modell MRX</b> • hinten 2-047-011 Index • vorne 2-043-013 Index • <b>21 Gang</b>	<b>Model MRX</b> • rear 2-047-011 Index • front 2-043-013 Index • <b>21 speed</b>	 UVP 21,90 €
<b>689602</b> 100 pair	<b>Modell MRX Micro</b> • hinten 204-609 Index • vorne 2-041-011 Micro Index • <b>18 Gang</b>	<b>Model MRX Micro</b> • rear 204-609 Index • front 2-041-011 Micro Index • <b>18 speed</b>	 UVP 20,90 €
<b>325449</b> 50	<b>DREHGRIFF-SCHALTER FÜR NABENSCHALTUNGEN</b> <b>3-fach Drehgriff-Schalter</b> • für <b>Nabenschaltungen</b> wie z. B. Nexus 3-Gang SG-3C41 • alternativer Drehgriffschalthebel zu Revo SL-3S41E • <b>Nirosta</b> -Innenzug 2.000 mm • Montageverpackung	<b>TWIST TYPE SHIFTER FOR INTERNAL GEAR HUBS</b> <b>3 speed Twist type shifter</b> • for <b>internal gear hubs</b> like e. g. Nexus 3 speed SG-3C41 • alternative twist lever to Revo SL-3S41E • <b>stainless steel</b> inner cable 2,000 mm • OEM	 UVP 7,90 €
<b>NEW</b> <b>325408</b> 100	<b>Modell DN85-8</b> • 8 Gang • Edelstahl-Innenzug 2.140 mm • rechts • Montageverpackung	<b>Model DN85-8</b> • 8 speed • stainless steel inner cable 2,140 mm • right • OEM	 UVP 14,90 €
<b>NEW</b> <b>325407</b> 100	<b>Modell DN85-7</b> • 7 Gang • Edelstahl-Innenzug 2.140 mm • rechts • Montageverpackung	<b>Model DN85-7</b> • 7 speed • stainless steel inner cable 2,140 mm • right • OEM	 UVP 14,90 €
<b>689575</b> 50 pair	<b>DREHGRIFF-SCHALTER</b> <b>Modell VENTURA</b> rechts Index und links Index, mit Kabel, Außenhülle und Griffe, <b>21 Gang</b>	<b>TWIST TYPE SHIFTER</b> <b>Model VENTURA</b> right Index and left Index, with cable, outer casing and grips, <b>21 speed</b>	 UVP 9,90 €
<b>689570</b> 50 pair	<b>Modell VENTURA</b> rechts Index und links Friction, mit Kabel, Außenhülle und Griffe, <b>18 Gang</b>	<b>Model VENTURA</b> right Index and left Friction, with cable, outer casing and grips, <b>18 speed</b>	 UVP 9,90 €
<b>680125</b> 100 pair	<b>SCHALTHEBEL</b> • <b>18 Gang</b> • rechts Index und links Friction • mit Kabel und Außenhülle	<b>SHIFT LEVER</b> • <b>18 speed</b> • right Index and left Friction, • with cable and outer casing	 UVP 6,90 €













ART.-NR. 	BESCHREIBUNG	DESCRIPTION	
<p><b>TIP</b></p> <p><b>680290</b> 100 set</p> <p><b>680291</b> 600/100 set</p>	<p><b>SCHALTUNGSRÄDCHEN &gt;PULLEY GUIDE&lt;</b></p> <ul style="list-style-type: none"> <li>• <b>seitliche Beweglichkeit</b> des oberen Schaltungsradchens <b>optimiert die Schaltfunktion</b></li> <li>• 2 Stück = 1 Set (mit 2 Rädchen, 4 Schalen, 2 Hülsen und 2 Schrauben)</li> <li>• 11 Zähne</li> <li>• passend für 9/10-fach</li> <li>• <b>lange Haltbarkeit</b> durch eingepresste Metallhülsen und hochwertige Gleitlager</li> </ul> <p>auf M-Wave Eurolochkarte</p> <p>Montageverpackung</p>	<p><b>PULLEY SET &gt;PULLEY GUIDE&lt;</b></p> <ul style="list-style-type: none"> <li>• <b>sidewise movability</b> of the upper pulley <b>optimises the shifting performance</b></li> <li>• 2 pieces = 1 set (with 2 pulleys, 4 cups, 2 bushes and 2 bolts)</li> <li>• 11 teeth</li> <li>• suitable for 9/10 speed</li> <li>• <b>long durability</b> because of pressed in metal bushes and high quality slide bearings</li> </ul> <p>on M-Wave eurohole card</p> <p>OEM</p> <p>UVP 14,90 € / set</p>	  
<p><b>680084</b></p> <p><b>680083</b> 500 set</p>	<p><b>SCHALTUNGSRÄDCHEN</b> 2 Stück = 1 Set im Polybeutel</p> <p><b>Maxi</b></p> <ul style="list-style-type: none"> <li>• Ø 50 mm</li> <li>• mit 13 Zähnen</li> <li>• passend für Shimano TX31, ... (kein original Shimano Ersatzteil)</li> <li>• mit 2 Rädchen, 2 Hülsen, 4 Schalen und 2 Schrauben</li> </ul> <p><b>Standard</b></p> <ul style="list-style-type: none"> <li>• Ø 34 mm</li> <li>• mit 10 Zähnen</li> <li>• ideal für 5-8-fach-Schaltwerk</li> <li>• mit 2 Rädchen, 2 Hülsen und 2 Schrauben</li> </ul>	<p><b>PULLEY SET</b> 2 pieces = 1 set in PE bag</p> <p><b>Maxi</b></p> <ul style="list-style-type: none"> <li>• Ø 50 mm</li> <li>• with 13 teeth</li> <li>• compatible to Shimano TX31, ... (no original Shimano spare part)</li> <li>• with 2 pulleys, 2 bushes, 4 cups and 2 bolts</li> </ul> <p>UVP 1,90 € / set</p> <p><b>Standard</b></p> <ul style="list-style-type: none"> <li>• Ø 34 mm</li> <li>• with 10 teeth</li> <li>• ideal for 5-8 speed rear derailleur</li> <li>• with 2 pulleys, 2 bushes and 2 bolts</li> </ul> <p>UVP 1,90 € / set</p>	 



# SAMOX



WWW.SAMOX.MESSINGSCHLAGER.COM

ART.-NR. 	BESCHREIBUNG	DESCRIPTION	
	<b>FREILAUFZAHNKRANZ</b>	<b>FREEWHEEL</b>	<b>FULL BALL</b>
	<ul style="list-style-type: none"> <li>• Full Ball</li> <li>• 1-fach</li> <li>• ½" x ⅛"</li> <li>• im Einzelkarton</li> </ul>	<ul style="list-style-type: none"> <li>• full ball</li> <li>• 1 speed</li> <li>• ½" x ⅛"</li> <li>• in box</li> </ul>	
• <b>700136</b> AD	16 Zähne, silber	16 teeth, silver	UVP 4,90 € UPV mAD 7,90 €
• <b>700138</b> AD 100	18 Zähne, silber	18 teeth, silver	
• <b>700134</b>	16 Zähne, braun	16 teeth, brown	
• <b>700133</b> 100/10	18 Zähne, braun	18 teeth, brown	
<b>NICE PRICE</b>		<b>NICE PRICE</b>	
	<b>FREILAUFZAHNKRANZ VENTURA / INDEX</b>	<b>FREEWHEEL VENTURA / INDEX</b>	
	<ul style="list-style-type: none"> <li>• mit Steighilfe</li> <li>• Index</li> <li>• silber</li> <li>• 13 - 32 Zähne</li> </ul>	<ul style="list-style-type: none"> <li>• HG-copy</li> <li>• Index</li> <li>• silver</li> <li>• 13 - 32 teeth</li> </ul>	
• <b>700196</b> AD 50	<b>9-fach</b>	<b>9 speed</b>	UVP 19,90 € UVP mAD 28,90 €
• <b>700164</b> AD 50	<b>8-fach</b>	<b>8 speed</b>	UVP 18,90 € UVP mAD 27,90 €
	<ul style="list-style-type: none"> <li>• mit Steighilfe</li> <li>• Index</li> <li>• schwarz/braun</li> <li>• im Einzelkarton</li> </ul>	<ul style="list-style-type: none"> <li>• HG-copy</li> <li>• Index</li> <li>• black/brown</li> <li>• in box</li> </ul>	
• <b>700176</b> AD	<b>7-fach</b> , 13 - 28 Zähne	<b>7 speed</b> , 13 - 28 teeth	UVP 13,90 € UVP mAD 20,90 €
• <b>700170</b> AD	<b>6-fach</b> , 14 - 28 Zähne	<b>6 speed</b> , 14 - 28 teeth	UVP 11,90 € UVP mAD 17,90 €
• <b>700173</b> AD 50	<b>5-fach</b> , 14 - 28 Zähne	<b>5 speed</b> , 14 - 28 teeth	UVP 11,90 € UVP mAD 17,90 €
	<b>700310</b>	<b>SPACER</b>	
2.000/10	<ul style="list-style-type: none"> <li>• Aluminium</li> <li>• ermöglicht die Verwendung von: <ul style="list-style-type: none"> <li>- 7-fach Kassetten auf 8/9/10-fach Kassettenkörpern</li> <li>- 10-fach (MTB+Rennrad) Kassetten auf 11-fach Kassettenkörper</li> <li>- 11-fach MTB-Kassetten auf 11-fach Rennradkassettenkörper</li> </ul> </li> </ul>	<ul style="list-style-type: none"> <li>• aluminium</li> <li>• for using <ul style="list-style-type: none"> <li>- 7 speed cassettes on 8/9/10 speed cassette bodies</li> <li>- 10 speed (MTB+road) cassettes on 11 speed cassette body</li> <li>- 11 speed MTB cassettes on 11 speed road cassette body</li> </ul> </li> </ul>	
			UVP 1,90 €

ART.-NR.	BESCHREIBUNG	DESCRIPTION	NICE PRICE	NICE PRICE
	<p><b>KASSETTENZAHNKRANZ</b></p> <ul style="list-style-type: none"> <li>• 11-fach</li> <li>• Shimano kompatibel</li> <li>• silber</li> </ul>	<p><b>CASSETTE SPROCKET</b></p> <ul style="list-style-type: none"> <li>• 11 speed</li> <li>• Shimano compatible</li> <li>• silver</li> </ul>		
<b>700155</b> 50	11 - 28 Zähne, Microshift	11 - 28 teeth, Microshift	UVP 44,90 €	
<b>700417</b> 50	11 - 32 Zähne, Microshift	11 - 32 teeth, Microshift	UVP 76,90 €	
<b>NEW</b> • <b>700148</b> AD 25	11 - 40 Zähne, Microshift	11 - 40 teeth, Microshift	UVP 56,90 € UVP mAD 82,90 €	
• <b>700149</b> AD 25	11 - 42 Zähne	11 - 42 teeth	UVP 56,90 € UVP mAD 82,90 €	
<b>700159</b> 25	11 - 42 Zähne, schwarz, Microshift	11 - 42 teeth, black, Microshift	UVP 89,90 €	
• <b>700156</b> AD 25	11 - 46 Zähne	11 - 46 teeth	UVP 59,90 € UVP mAD 89,90 €	
	<p><b>KASSETTENZAHNKRANZ</b></p> <ul style="list-style-type: none"> <li>• 10-fach</li> <li>• mit Distanzring</li> <li>• silber</li> <li>• Shimano kompatibel</li> </ul>	<p><b>CASSETTE SPROCKET</b></p> <ul style="list-style-type: none"> <li>• 10 speed</li> <li>• with spacer</li> <li>• silver</li> <li>• Shimano compatible</li> </ul>		 
<b>700152</b> 50	11 - 25 Zähne, <b>nur 274 g</b> , Microshift	11 - 25 teeth, <b>only 274 g</b> , Microshift		
<b>700153</b> 50	11 - 28 Zähne, Microshift	11 - 28 teeth, Microshift	UVP 35,90 €	
<b>700158</b> 30	11 - 36 Zähne, <b>nur 446 g</b> , Microshift	11 - 36 teeth, <b>only 446 g</b> , Microshift	UVP 43,90 €	
• <b>700194</b> AD 50	11 - 36 Zähne, <b>nur 464 g</b>	11 - 36 teeth, <b>only 464 g</b>	UVP 29,90 € UVP mAD 43,90 €	
• <b>700154</b> AD 30	11 - 42 Zähne	11 - 42 teeth	UVP 44,90 € UVP mAD 64,90 €	
	<p><b>KASSETTENZAHNKRANZ</b></p> <ul style="list-style-type: none"> <li>• 9-fach</li> <li>• silber</li> <li>• Shimano kompatibel</li> </ul>	<p><b>CASSETTE SPROCKET</b></p> <ul style="list-style-type: none"> <li>• 9 speed</li> <li>• silver</li> <li>• Shimano compatible</li> </ul>		
• <b>700195</b> AD 50	11 - 32 Zähne	11 - 32 teeth	UVP 19,90 € UVP mAD 28,90 €	
• <b>700145</b> AD 50	11 - 25 Zähne	11 - 25 teeth	UVP 19,90 € UVP mAD 28,90 €	
• <b>700168</b> AD 50	<p><b>KASSETTENZAHNKRANZ</b></p> <ul style="list-style-type: none"> <li>• 8-fach</li> <li>• 11 - 32 Zähne</li> <li>• silber</li> <li>• Shimano kompatibel</li> </ul>	<p><b>CASSETTE SPROCKET</b></p> <ul style="list-style-type: none"> <li>• 8 speed</li> <li>• 11 - 32 teeth</li> <li>• silver</li> <li>• Shimano compatible</li> </ul>		
			UVP 16,90 € UVP mAD 24,90 €	
• <b>700167</b> AD 50	<p><b>KASSETTENZAHNKRANZ</b></p> <ul style="list-style-type: none"> <li>• 7-fach</li> <li>• 11 - 28 Zähne</li> <li>• silber</li> <li>• Index</li> <li>• Shimano kompatibel</li> </ul>	<p><b>CASSETTE SPROCKET</b></p> <ul style="list-style-type: none"> <li>• 7 speed</li> <li>• 11 - 28 teeth</li> <li>• silver</li> <li>• Index</li> <li>• Shimano compatible</li> </ul>		
			UVP 13,90 € UVP mAD 20,90 €	

ART.-NR. 	BESCHREIBUNG	DESCRIPTION	
	<b>KABELBINDER</b>	<b>CABLE TIES</b>	
	<ul style="list-style-type: none"> <li>• schwarz</li> <li>• Abmessungen in mm</li> <li>• Preis per 1.000 Stück</li> <li>• 100 Stück im Polybeutel</li> </ul>	<ul style="list-style-type: none"> <li>• black</li> <li>• size in mm</li> <li>• price per 1,000 pcs</li> <li>• 100 pcs in PE bag</li> </ul>	
<b>884400</b> 20.000/100	2,5 x 100 mm	2.5 x 100 mm	UVP 19,90 €/1.000
<b>884401</b> 20.000/100	2,5 x 150 mm	2.5 x 150 mm	UVP 29,90 €/1.000
<b>884402</b> 10.000/100	7,2 x 200 mm (für Flaschenhalter-, Ringschlossbefestigung, ...)	7.2 x 200 mm (for fixing bottle cages, ring locks, ...)	UVP 119,90 €/1.000
<b>884403</b> 20.000/100	2,5 x 200 mm	2.5 x 200 mm	UVP 39,90 €/1.000
<b>884404</b> 10.000/100	3,6 x 300 mm	3.6 x 300 mm	UVP 69,90 €/1.000
	<b>VERPACKUNGSKARTONS</b>	<b>BOXES</b>	
	<ul style="list-style-type: none"> <li>• brauner Wellkarton</li> <li>• laschengeklebt</li> <li>• zusammenstoßende Deckel- und Bodenklappen</li> </ul>	<ul style="list-style-type: none"> <li>• brown corrugated cardboard</li> <li>• flaps glued</li> <li>• impinging top and down flaps</li> </ul>	
<b>084414</b> 10	<ul style="list-style-type: none"> <li>• 190 x 190 x 95 mm</li> <li>• zu 10 Stück gebündelt</li> <li>• mit <b>Automatikboden</b> zum <b>schnellen (Ent-)falten</b></li> </ul>	<ul style="list-style-type: none"> <li>• 190 x 190 x 95 mm</li> <li>• bundles of 10 pcs</li> <li>• with <b>automatic base</b> for <b>fast (un-)folding</b></li> </ul>	UVP 1,19 €
<b>084410</b> 15	<ul style="list-style-type: none"> <li>• 280 x 280 x 280 mm</li> <li>• zu 15 Stück gebündelt</li> </ul>	<ul style="list-style-type: none"> <li>• 280 x 280 x 280 mm</li> <li>• bundles of 15 pcs</li> </ul>	UVP 2,49 €
<b>084593</b> 15	<ul style="list-style-type: none"> <li>• 400 x 400 x 300 mm</li> <li>• zu 15 Stück gebündelt</li> </ul>	<ul style="list-style-type: none"> <li>• 400 x 400 x 300 mm</li> <li>• bundles of 15 pcs</li> </ul>	UVP 2,99 €
<b>084565</b> 15	<ul style="list-style-type: none"> <li>• 550 x 350 x 350 mm</li> <li>• zu 15 Stück gebündelt</li> </ul>	<ul style="list-style-type: none"> <li>• 550 x 350 x 350 mm</li> <li>• bundles of 15 pcs</li> </ul>	UVP 4,90 €
<b>084223</b> 15	<ul style="list-style-type: none"> <li>• 600 x 400 x 190 mm</li> <li>• zu 15 Stück gebündelt</li> </ul>	<ul style="list-style-type: none"> <li>• 600 x 400 x 190 mm</li> <li>• bundles of 15 pcs</li> </ul>	UVP 4,90 €
<b>084028</b> 105	<ul style="list-style-type: none"> <li>• 560 x 560 x 730 mm</li> </ul>	<ul style="list-style-type: none"> <li>• 560 x 560 x 730 mm</li> </ul>	UVP 6,90 €
<b>084224</b> 20	<ul style="list-style-type: none"> <li>• 800 x 300 x 190 mm</li> <li>• zu 20 Stück gebündelt</li> </ul>	<ul style="list-style-type: none"> <li>• 800 x 300 x 190 mm</li> <li>• bundles of 20 pcs</li> </ul>	UVP 4,90 €
<b>084562</b> 90	<ul style="list-style-type: none"> <li>• 800 x 400 x 430 mm</li> </ul>	<ul style="list-style-type: none"> <li>• 800 x 400 x 430 mm</li> </ul>	UVP 5,90 €
<b>084554</b> 90	<ul style="list-style-type: none"> <li>• 800 x 800 x 300 mm</li> <li>• geeignet für Fahrradreifen, ...</li> <li>• gefaltete Größe (160 x 112 cm), Palettenmaß</li> </ul>	<ul style="list-style-type: none"> <li>• 800 x 800 x 300 mm</li> <li>• suitable for bicycle wheels, ...</li> <li>• folded size (160 x 112 cm), pallet size</li> </ul>	UVP 11,90 €
<b>084579</b> 90	<ul style="list-style-type: none"> <li>• ca. 1.090 x 220 x 610 mm</li> <li>• geeignet für Fahrradrahmen, ...</li> <li>• gefaltete Größe (132 x 108 cm), Palettenmaß</li> </ul>	<ul style="list-style-type: none"> <li>• ca. 1.090 x 220 x 610 mm</li> <li>• suitable for bicycle frames, ...</li> <li>• folded size (132 x 108 cm), pallet size</li> </ul>	UVP 8,90 €
<b>086550</b> 36	<b>PVC-PACKBAND</b>	<b>PVC PACKAGING TAPE</b>	
	<ul style="list-style-type: none"> <li>• <b>Premiumqualität</b></li> <li>• transparent</li> <li>• 50 mm x 66 lfm</li> <li>• 4-fach nylonverstärkt</li> <li>• Naturkautschuk</li> <li>• Lagerung nicht über 20 °C</li> </ul>	<ul style="list-style-type: none"> <li>• <b>premium quality</b></li> <li>• transparent</li> <li>• 50 mm x 66 m</li> <li>• fourfold nylon reinforced</li> <li>• natural rubber</li> <li>• storage not over 20 °C</li> </ul>	UVP 5,90 €
<b>087579</b> 36	<b>KLEBEBAND</b>	<b>ADHESIVE TAPE</b>	
	<ul style="list-style-type: none"> <li>• Standardqualität</li> <li>• transparent</li> <li>• 48 mm x 66 lfm</li> <li>• Lagerung nicht über 20 °C</li> </ul>	<ul style="list-style-type: none"> <li>• standard quality</li> <li>• transparent</li> <li>• 48 mm x 66 m</li> <li>• storage not over 20 °C</li> </ul>	UVP 2,49 €

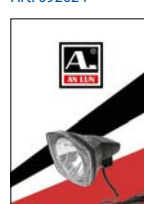

ART.-NR.	BESCHREIBUNG	DESCRIPTION	
			
<b>719906</b> 100 set	<b>BIKE-SCHLÜSSELANHÄNGER</b> • Aluminium • farbig sortiert • 1 Set = 12 Stück auf Ventura Displaykarte	<b>BIKE KEY FOB</b> • aluminium • assorted colours • 1 set = 12 pcs on Ventura display card UVP 14,90 € / set	
<b>719907</b> 100	• mit Messingschlag Logo • blau • im Polybeutel	• with Messingschlag logo • blue • in PE bag UVP 1,50 €	
<b>719908</b> 100	• mit M-Wave Logo • hellblau • im Polybeutel	• with M-Wave logo • light blue • in PE bag UVP 1,50 €	
<b>092006</b>	<b>UNSER HAUPTKATALOG</b>  <b>Messingschlag Hauptkatalog</b> mit Registerstanzung	<b>OUR MAIN CATALOGUE</b>  <b>Messingschlag version</b> with register press cut  UVP 14,90 €	
	<b>PROSPEKTE</b>  Wir unterstützen mit vielen individuellen zweisprachigen (deutsch, englisch) Prospekten gezielt den Verkauf unserer Marken. Unter <a href="http://www.messingschlag.com">www.messingschlag.com</a> finden Sie unsere Markenprospekte zum Download. Die M-Wave- und E-Mobility-Prospekte sind auch in gedruckter Form erhältlich	<b>BROCHURES</b>  We support the sale of our brands specifically with many individual bilingual (German, English) brochures. Under <a href="http://www.messingschlag.com">www.messingschlag.com</a> you will find our brand brochures for download. The M-Wave and E-Mobility brochures are also available in printed form.	
<b>092016</b>	M-Wave		Art. 092016
<b>092038</b>	E-Mobility Solutions Concepts Deutsch / German		Art. 092038/9
<b>092039</b>	E-Mobility Solutions Concepts Englisch / English		Art. 092048
<b>092048</b>	E-Mobility Solutions Parts Deutsch/Englisch / German/English		Art. 092015
<b>092015</b>	Kenda		Art. 092029
<b>092029</b>	Beto		Art. 092043
<b>092043</b>	Samox		Art. 092021
<b>092021</b>	Velo		Art. 092017
<b>092017</b>	Microshift		Art. 092019
<b>092019</b>	Novatec		Art. 092014
<b>092014</b>	Exustar		Art. 092044
<b>092044</b>	Litemove		Art. 092020
<b>092020</b>	Smart		Art. 092022
<b>092022</b>	Neco		Art. 092024
<b>092024</b>	Super B		Art. 092037
<b>092037</b>	Kujo		Art. 092030
<b>092030</b>	Moon		Art. 092027
<b>092027</b>	cnSpoke		Art. 092050
<b>092050</b>	Motul		Art. 092026
<b>092026</b>	Anlun		Art. 092028
<b>092028</b>	Trailgator		





1. Geltung
  - a) Allen Vereinbarungen und Angeboten zwischen uns und unseren Kunden liegen diese Allgemeinen Geschäftsbedingungen (im Folgenden AGB) zugrunde. Änderungen sowie abweichende Bedingungen des Kunden werden nur dann Vertragsinhalt, wenn wir ihnen ausdrücklich zustimmen; gleiches gilt für den Ausschluss dieser AGB.
  - b) Die AGB gelten auch für alle zukünftigen Lieferungen, Leistungen und Angebote, auch wenn sie nicht nochmals gesondert vereinbart werden.
  - c) Die AGB gelten ausschließlich gegenüber Bestellern, die Unternehmer im Sinn von § 14 BGB, eine juristische Person des öffentlichen Rechts und öffentlich-rechtliche Sondervermögen sind (§ 310 BGB).
  - d) Auch wenn diese AGB in englischer oder einer anderen Sprache zur Verfügung gestellt werden, ist allein die deutsche Textversion maßgeblich.
  - e) Rechtserhebliche Erklärungen und Anzeigen des Lieferanten in Bezug auf den Vertrag (z. B. Fristsetzung, Mahnung, Rücktritt) sind schriftlich abzugeben. Schriftlichkeit im Sinne dieser AGB schließt Schrift- und Textform (z. B. Brief, E-Mail, Telefax) ein. Gesetzliche Formvorschriften und weitere Nachweise insbesondere bei Zweifeln über die Legitimation des Erklärenden bleiben unberührt.

2. Angebot, Vertragsabschluss
  - a) Unsere Angebote sind freibleibend, soweit sich aus dem Angebot nichts anderes ergibt.
  - b) Die Bestellung des Kunden ist ein bindendes Angebot. Wir sind berechtigt, dieses Angebot innerhalb von 21 Tagen ab Datum der Bestellung anzunehmen. In der Regel erfolgt die Annahme durch eine Auftragsbestätigung. Die Leistungsdurchführung innerhalb dieser Frist gilt ebenfalls als Annahme des Angebots.
  - c) Bei den unseren Angeboten angeschlossenen bzw. zugrunde liegenden Zeichnungen, Abbildungen, Beschreibungen, Plänen, Prospekten oder ähnlichen Unterlagen handelt es sich um unverbindliche Informationen, die nicht Vertragsinhalt werden, es sei denn, es wird ausdrücklich schriftlich vereinbart, dass entsprechende Unterlagen bzw. ein bestimmter Inhalt dieser Unterlagen Vertragsinhalt wird.

3. Preise, Zahlungsbedingungen
  - a) Unsere Preise bestimmen sich – sofern nicht ausdrücklich bestimmte Preise vereinbart sind – nach unserem am Tag der Auslieferung gültigen Preislisten.
  - b) Sämtliche angegebene Preise sind Nettopreise, zu denen Umsatzsteuer in der jeweils gesetzlichen Höhe sowie Verpackungs- und Transportkosten hinzuzurechnen sind.
  - c) Wir behalten uns das Recht vor, bei Verträgen mit einer vereinbarten Lieferzeit von mehr als 4 Monaten fest vereinbarte Preise entsprechend den eingetretenen Kostenänderungen, insbesondere bei Material-, Lohn- und sonstige Nebenkostenänderungen, zu erhöhen oder herabzusetzen. Beträgt die Erhöhung mehr als 5 % des vereinbarten Preises, so steht dem Kunden ein Vertragslösungsrecht (Kündigung oder Rücktritt) zu.
  - d) Sofern sich aus unserer Auftragsbestätigung, einer Vereinbarung oder der Rechnung nichts anderes ergibt, sind die Preise ohne Abzug sofort zur Zahlung fällig.
  - e) Wir sind berechtigt, noch ausstehende Lieferungen oder Leistungen nur gegen Vorauszahlung oder Sicherheitsleistung auszuführen oder zu erbringen, wenn uns nach Abschluss des Vertrages Umstände bekannt werden, welche die Kreditwürdigkeit des Kunden wesentlich zu mindern geeignet sind und durch welche die Bezahlung unserer offenen Forderungen durch den Kunden gefährdet wird.

4. Lieferung, Lieferzeit- und -frist, Teillieferung, Gefahrübergang, Annahmeverzug
  - a) Von uns angegebene Lieferzeiten oder Lieferfristen sind unverbindlich, es sei denn, eine bestimmte Lieferzeit oder Lieferfrist wird ausdrücklich als verbindlich vereinbart. Der Beginn der Lieferzeit oder -frist setzt die Abklärung aller technischer Fragen und die rechtzeitige und ordnungsgemäße Erfüllung der Verpflichtungen, insbesondere etwaiger Mitwirkungspflichten, des Kunden voraus.
  - b) Wir sind berechtigt, die vertragliche Leistung in Teillieferungen zu erbringen, sofern diese dem Kunden zumutbar sind.
  - c) Ist die Lieferung auf Abruf vereinbart, so hat der Kunde innerhalb angemessener Frist abzurufen.
  - d) Wird die Lieferung durch höhere Gewalt, behördliche Maßnahmen, Betriebsstilllegung, Streik oder ähnliche Umstände – auch bei unseren Lieferanten – unmöglich oder übermäßig erschwert, so werden wir für die Dauer der Behinderung und deren Nachwirkung von der Lieferpflicht frei. Überschreiten die daraus ergebenden Verzögerungen den Zeitraum von 6 Wochen, so sind beide Vertragspartner berechtigt, hinsichtlich des betroffenen Leistungsumfanges vom Vertrag zurückzutreten. Im Falle der Nichtbelieferung oder ungenügender Belieferung durch unsere Lieferanten sind wir von unseren Lieferungsverpflichtungen ganz oder teilweise entbunden. Dies gilt nur dann, wenn wir die erforderlichen Vorkehrungen zur Beschaffung der von uns zu liefernden Ware getroffen haben. Wir verpflichten uns, in diesem Fall unsere Ansprüche gegen den Lieferanten an den Kunden auf diesen Verlangen abzutreten. Weitere Ansprüche bestehen nicht.
  - e) Die Lieferung erfolgt „ab Werk“ auf Kosten und Gefahr des Kunden, es sei denn, im Einzelfall ist etwas anderes vereinbart.
  - f) Die Gefahr des zufälligen Untergangs und der zufälligen Verschlechterung der Lieferung geht mit der Auslieferung an den Spediteur, den Frachtführer oder sonst zur Ausführung der Versendung bestimmten Person auf den Kunden über.
  - g) Kommt der Kunde in Annahmeverzug oder verletzt er schuldhaft sonstige Mitwirkungspflichten, so sind wir berechtigt, den uns insoweit entstehenden Schaden, einschließlich etwaiger Mehraufwendungen (insbesondere Lagerkosten) ersetzt zu verlangen.

Weitergehende Ansprüche bleiben vorbehalten. Außerdem geht in diesem Fall die Gefahr eines zufälligen Untergangs oder einer zufälligen Verschlechterung der Lieferung in Abweichung von f) in dem Zeitpunkt auf den Kunden über, in dem dieser in Annahmeverzug geraten ist.

5. Mängelhaftung/Gewährleistung
  - a) Für die Rechte des Kunden bei Sach- und Rechtsmängeln (einschließlich Falsch- und Minderlieferung sowie unsachgemäßer Montage/Installation oder mangelhafter Anleitungen) gelten die gesetzlichen Vorschriften, soweit nachfolgend nichts anderes bestimmt ist. In allen Fällen unberührt bleiben die gesetzlichen Bestimmungen über den Verbrauchsgüterkauf (§§ 474 ff. BGB) und die Rechte des Kunden aus gesondert abgegebenen Garantien insbesondere des Herstellers.
  - b) Grundlage unserer Mängelhaftung ist vor allem die über die Beschaffenheit und die vorausgesetzte Verwendung der Ware (einschließlich

Zubehör und Anleitungen) getroffene Vereinbarung. Als Beschaffenheitsvereinbarung in diesem Sinne gelten alle Produktbeschreibungen und Herstellerangaben, die Gegenstand des einzelnen Vertrages sind oder von uns (insbesondere in Katalogen oder auf unserer Internet-Homepage) zum Zeitpunkt des Vertragsschlusses öffentlich bekannt gemacht waren. Soweit die Beschaffenheit nicht vereinbart wurde, ist nach der gesetzlichen Regelung zu beurteilen, ob ein Mangel vorliegt oder nicht (§ 434 Abs. 3 BGB). Öffentliche Äußerungen des Herstellers oder in seinem Auftrag insbes. in der Werbung oder auf dem Etikett der Ware gehen dabei Äußerungen sonstiger Dritter vor.

- c) Bei Waren mit digitalen Elementen oder sonstigen digitalen Inhalten schulden wir eine Bereitstellung und ggf. eine Aktualisierung der digitalen Inhalte nur, soweit sich dies ausdrücklich aus einer Beschaffenheitsvereinbarung gem. lit. b) ergibt. Für öffentliche Äußerungen des Herstellers und sonstiger Dritter übernehmen wir insoweit keine Haftung.
- d) Wir haften grundsätzlich nicht für Mängel, die der Kunde bei Vertragsschluss kennt oder grob fahrlässig nicht kennt (§ 442 BGB). Weiterhin setzen die Mängelansprüche des Kunden voraus, dass er seinen gesetzlichen Untersuchungs- und Anzeigepflichten (§§ 377, 381 HGB) nachgegangen ist. Bei Baustoffen und anderen, zum Einbau oder sonstigen Weiterverarbeitung bestimmten Waren hat eine Untersuchung in jedem Fall unmittelbar vor der Verarbeitung zu erfolgen. Zeigt sich bei der Lieferung, der Untersuchung oder zu irgendeinem späteren Zeitpunkt ein Mangel, so ist uns hiervon unverzüglich schriftlich Anzeige zu machen. Versäumt der Kunde die ordnungsgemäße Untersuchung und/oder Mängelanzeige, ist unsere Haftung für den nicht bzw. nicht rechtzeitig oder nicht ordnungsgemäß angezeigten Mangel nach den gesetzlichen Vorschriften ausgeschlossen. Bei einer zum Einbau, zur Anbringung oder Installation bestimmten Ware gilt dies auch dann, wenn der Mangel infolge der Verletzung einer dieser Pflichten erst nach der entsprechenden Verarbeitung offenbar wurde; in diesem Fall bestehen insbesondere keine Ansprüche des Kunden auf Ersatz entsprechender Kosten („Aus- und Einbaukosten“).
- e) Ist die gelieferte Sache mangelhaft, können wir zunächst wählen, ob wir Nacherfüllung durch Beseitigung des Mangels (Nachbesserung) oder durch Lieferung einer mangelfreien Sache (Ersatzlieferung) leisten. Ist die von uns gewählte Art der Nacherfüllung im Einzelfall für den Kunden unzumutbar, kann er sie ablehnen. Unser Recht, die Nacherfüllung unter den gesetzlichen Voraussetzungen zu verweigern, bleibt unberührt.
- f) Wir sind berechtigt, die geschuldete Nacherfüllung davon abhängig zu machen, dass der Kunde den fälligen Kaufpreis bezahlt. Der Kunde ist jedoch berechtigt, einen im Verhältnis zum Mangel angemessenen Teil des Kaufpreises zurückzubehalten.
- g) Der Kunde hat uns die zur geschuldeten Nacherfüllung erforderliche Zeit und Gelegenheit zu geben, insbesondere die beanstandete Ware zu Prüfungswecken zu übergeben. Im Falle der Ersatzlieferung hat uns der Kunde die mangelhafte Sache auf unser Verlangen nach den gesetzlichen Vorschriften zurückzugeben; einen Rückgabeanspruch hat der Kunde jedoch nicht. Die Nacherfüllung beinhaltet weder den Ausbau, die Entfernung oder Desinstallation der mangelhaften Sache noch den Einbau, die Anbringung oder die Installation einer mangelfreien Sache, wenn wir ursprünglich nicht zu diesen Leistungen verpflichtet waren; Ansprüche des Kunden auf Ersatz entsprechender Kosten („Aus- und Einbaukosten“) bleiben unberührt.
- h) Die zum Zweck der Prüfung und Nacherfüllung erforderlichen Aufwendungen, insbesondere Transport-, Wege-, Arbeits- und Materialkosten sowie ggf. Aus- und Einbaukosten tragen bzw. erstatten wir nach Maßgabe der gesetzlichen Regelung und diesen AGB, wenn tatsächlich ein Mangel vorliegt. Andernfalls können wir vom Kunden die aus dem unberechtigten Mängelbeseitigungsverlangen entstandenen Kosten ersetzt verlangen, wenn der Kunde wusste oder hätte erkennen können, dass tatsächlich kein Mangel vorliegt.
- i) In dringenden Fällen, z. B. bei Gefährdung der Betriebssicherheit oder zur Abwehr unverhältnismäßiger Schäden, hat der Kunde das Recht, den Mangel selbst zu beseitigen und von uns Ersatz der hierzu objektiv erforderlichen Aufwendungen zu verlangen. Von einer derartigen Selbstvornahme sind wir unverzüglich, nach Möglichkeit vorher, zu benachrichtigen. Das Selbstvornahmerecht besteht nicht, wenn wir berechtigt wären, eine entsprechende Nacherfüllung nach den gesetzlichen Vorschriften zu verweigern.
- j) Wenn eine für die Nacherfüllung vom Kunden zu setzende angemessene Frist erfolglos abgelaufen oder nach den gesetzlichen Vorschriften entbehrlich ist, kann der Kunde nach den gesetzlichen Vorschriften vom Kaufvertrag zurücktreten oder den Kaufpreis mindern. Bei einem unerheblichen Mangel besteht jedoch kein Rücktrittsrecht.
- k) Ansprüche des Kunden auf Aufwendungsersatz gem. § 445a Abs. 1 BGB sind ausgeschlossen, es sei denn, der letzte Vertrag in der Lieferkette ist ein Verbrauchsgüterkauf (§§ 478, 474 BGB) oder ein Verbrauchervertrag über die Bereitstellung digitaler Produkte (§§ 445c S. 2, 327 Abs. 5, 327u BGB). Ansprüche des Kunden auf Schadensersatz oder Ersatz vergeblicher Aufwendungen (§ 284 BGB) bestehen auch bei Mängeln der Ware nur nach Maßgabe nachfolgender Nr. 6 und 7.

6. Sonstige Haftung
  - a) Soweit sich aus diesen AGB einschließlich der nachfolgenden Bestimmungen nichts anderes ergibt, haften wir bei einer Verletzung von vertraglichen und außervertraglichen Pflichten nach den gesetzlichen Vorschriften.
  - b) Auf Schadensersatz haften wir – gleich aus welchem Rechtsgrund – im Rahmen der Verschuldenshaftung bei Vorsatz und grober Fahrlässigkeit. Bei einfacher Fahrlässigkeit haften wir, vorbehaltlich gesetzlicher Haftungsbeschränkungen (z. B. Sorgfalt in eigenen Angelegenheiten; unerhebliche Pflichtverletzung), nur
    - für Schäden aus der Verletzung des Lebens, des Körpers oder der Gesundheit,
    - für Schäden aus der Verletzung einer wesentlichen Vertragspflicht (Verpflichtung, deren Erfüllung die ordnungsgemäße Durchführung des Vertrags überhaupt erst ermöglicht und auf deren Einhaltung der Vertragspartner regelmäßig vertraut und vertrauen darf); in diesem Fall ist unsere Haftung jedoch auf den Ersatz des vorhersehbaren, typischerweise eintretenden Schadens begrenzt.
  - c) Die sich aus lit. b) ergebenden Haftungsbeschränkungen gelten auch gegenüber Dritten sowie bei Pflichtverletzungen durch Personen (auch zu ihren Gunsten), deren Verschulden wir nach gesetzlichen Vorschriften zu vertreten haben. Sie gelten nicht, soweit ein Mangel arglistig verschwiegen wurde und für Ansprüche des Käufers nach dem Produkthaftungsgesetz.
  - d) Wegen einer Pflichtverletzung, die nicht in einem Mangel besteht, kann der Käufer nur zurücktreten oder kündigen, wenn wir die Pflichtverletzung zu vertreten haben. Ein freies Kündigungsrecht des Käufers (insbesondere gem. §§ 650, 648 BGB) wird ausgeschlossen. Im Übrigen gelten die gesetzlichen Voraussetzungen und Rechtsfolgen.

7. Verjährung
  - a) Abweichend von § 438 Abs. 1 Nr. 3 BGB beträgt die allgemeine Verjährungsfrist für Ansprüche aus Sach- und Rechtsmängeln ein Jahr ab Ablieferung. Soweit eine Abnahme vereinbart ist, beginnt die Verjährung mit der Abnahme.
  - b) Handelt es sich bei der Ware um ein Bauwerk oder eine Sache, die entsprechend ihrer üblichen Verwendungsweise für ein Bauwerk verwendet werden ist und dessen Mangelhaftigkeit verursacht hat (Baustoff), beträgt die Verjährungsfrist gem. der gesetzlichen Regelung 5 Jahre ab Ablieferung (§ 438 Abs. 1 Nr. 2 BGB). Unberührt bleiben auch weitere gesetzliche Sonderregelungen zur Verjährung (insbes. § 438 Abs. 1 Nr. 1, Abs. 3, §§ 444, 445b BGB).
  - c) Die vorstehenden Verjährungsfristen des Kaufrechts gelten auch für vertragliche und außervertragliche Schadensersatzansprüche des Käufers, die auf einem Mangel der Ware beruhen, es sei denn die Anwendung der regelmäßigen gesetzlichen Verjährung (§§ 195, 199 BGB) würde im Einzelfall zu einer kürzeren Verjährung führen. Schadensersatzansprüche des Käufers gem. Nr. 6 lit. b) S. 1 und S. 2 (aa) sowie nach dem Produkthaftungsgesetz verjähren ausschließlich nach den gesetzlichen Verjährungsfristen.

8. Eigentumsvorbehalt
  - a) Wir behalten uns das Eigentum an den Waren bzw. Liefergegenständen bis zum Eingang aller Zahlungen aus dem Liefervertrag vor (Vorbehaltsware). Bei vertragswidrigem Verhalten des Kunden, insbesondere bei Zahlungsverzug, sind wir berechtigt, die Vorbehaltsware zurückzunehmen. In der Zurücknahme durch uns liegt kein Rücktritt vom Vertrag vor, es sei denn, wir hätten dies ausdrücklich schriftlich erklärt. In der Pfändung der Waren durch uns liegt stets ein Rücktritt vom Vertrag vor. Wir sind nach Rücknahme der Vorbehaltsware zu deren Verwertung befugt, der Verwertungserlös ist auf die Verbindlichkeiten des Kunden – abzüglich angemessener Verwertungskosten – anzurechnen.
  - b) Der Kunde ist verpflichtet, die Vorbehaltsware pfleglich zu behandeln; insbesondere ist er verpflichtet, diese auf eigene Kosten gegen Feuer-, Wasser- und Diebstahlschäden ausreichend zum Neuwert zu versichern.
  - c) Bei Pfändungen oder sonstigen Eingriffen Dritter hat uns der Kunde unverzüglich schriftlich zu benachrichtigen, damit wir Klage gemäß § 771 ZPO erheben können. Soweit der Dritte nicht in der Lage ist, uns die gerichtlichen und außergerichtlichen Kosten einer Klage gemäß § 771 ZPO zu erstatten, haftet der Kunde für den uns entstandenen Ausfall.
  - d) Der Kunde ist berechtigt, die Vorbehaltsware im ordentlichen Geschäftsgang weiter zu verkaufen; er tritt uns jedoch bereits jetzt alle Forderungen in Höhe des Faktura-Endbetrages (einschließlich Umsatzsteuer) unserer Forderung ab, die ihm aus der Weiterveräußerung gegen seine Abnehmer oder Dritte erwachsen, und zwar unabhängig davon, ob die Vorbehaltsware ohne oder nach Verarbeitung weiter verkauft worden ist. Zur Einziehung dieser Forderung bleibt der Kunde auch nach der Abtretung ermächtigt. Unsere Befugnis, die Forderung selbst einzuziehen, bleibt hiervon unberührt. Wir verpflichten uns jedoch, die Forderung nicht einzuziehen, solange der Kunde seinen Zahlungsverpflichtungen aus den vereinnahmten Erlösen nachkommt, nicht in Zahlungsverzug gerät und insbesondere kein Antrag auf Eröffnung eines Konkurs- oder Vergleichs- oder Insolvenzverfahrens gestellt ist oder Zahlungsverzug vorliegt. Ist aber dies der Fall, so können wir verlangen, dass der Kunde uns die abgetretenen Forderungen und deren Schuldner bekannt gibt, alle zum Einzug erforderlichen Angaben macht, die zugehörigen Unterlagen aushändigt und den Schuldner (Dritten) die Abtretung mitteilt.
  - e) Die Verarbeitung oder Umbildung der Vorbehaltsware durch den Kunden wird stets für uns vorgenommen. Wird sie mit anderen, uns nicht gehörenden Gegenständen verarbeitet, so erwerben wir das Miteigentum an der neuen Sache im Verhältnis des Wertes der gekauften Sache (Faktura-Endbetrag einschließlich Umsatzsteuer) zu den anderen verarbeiteten Gegenständen zur Zeit der Verarbeitung. Für die durch Verarbeitung entstehende Sache gilt im Übrigen das gleiche wie für die Vorbehaltsware.
  - f) Wird die Vorbehaltsware mit anderen, uns nicht gehörenden Gegenständen untrennbar vermischt, so erwerben wir das Miteigentum an der neuen Sache im Verhältnis des Wertes der Vorbehaltsware (Faktura-Endbetrag einschließlich Umsatzsteuer) zu den anderen vermischt Gegenständen zum Zeitpunkt der Vermischung. Erfolgt die Vermischung in der Weise, dass die Sache des Kunden als Hauptsache anzusehen ist, so gilt als vereinbart, dass der Kunde uns anteilmäßig Miteigentum überträgt. Der Kunde verwahrt das so entstandene Alleineigentum oder Miteigentum für uns.
  - g) Wir verpflichten uns, die uns zustehenden Sicherheiten auf Verlangen des Kunden insoweit freizugeben, als der realisierbare Wert unserer Sicherheiten die zu sichernden Forderungen um mehr als 10% übersteigt; die Auswahl der freizugebenden Sicherheiten obliegt uns.

9. Schutzrechte
 

Der Kunde hat die die Liefergegenstände betreffenden Schutzrechte, insbesondere Urheber-, Marken-, Patentrechte sowie Rechte am Design zu wahren und zwar unabhängig davon, ob diese uns oder unseren Lieferanten bzw. Herstellern zustehen. Unsere Produkte sind unser geistiges Eigentum. Es ist dem Kunden nicht gestattet, diese nachzubauen, sich irgendwelche Schutzrechte zu sichern oder sie sonst in irgendeiner Form auszubeten.

10. Datenschutz
 

Personenbezogene Daten werden von Ihnen als Kunden erhoben, gespeichert, verarbeitet und genutzt, wenn, soweit und solange dies für die Begründung, die Durchführung oder die Beendigung des Vertragsverhältnisses erforderlich ist. Eine weitergehende Erhebung, Speicherung, Verarbeitung und Nutzung personenbezogener Daten erfolgt nur, soweit eine Rechtsvorschrift dies erfordert oder erlaubt oder Sie hierzu eingewilligt haben. Zur Durchführung vorvertraglicher Maßnahmen und zur Erfüllung des Vertragsverhältnisses bzw. zur Erfüllung einzelner Kaufverträge und Bestellungen kann insbesondere die Erhebung, Verarbeitung und Nutzung des Namens von Personen, deren Adresse, weiterer Kommunikationsdaten, der Umsatzsteuerident.-Nr. oder auch der Bankdaten erforderlich sein. Rechtsgrundlage hierfür ist insbesondere Art. 6 Abs. 1 lit. b) und c) DS-GVO. Im Übrigen verweisen wir auf unsere Datenschutzerklärung, die unter [www.messingschlagere.com/de/datenschutz](http://www.messingschlagere.com/de/datenschutz) einsehbar ist.

11. Rechtswahl und Gerichtsstand
  - a) Für diese AGB und die Vertragsbeziehung zwischen uns und dem Kunden gilt das Recht der Bundesrepublik Deutschland unter Ausschluss internationalen Einheitsrechts, insbesondere des UN-Kaufrechts.
  - b) Ist der Kunde Kaufmann iSd Handelsgesetzbooks, juristische Person des öffentlichen Rechts oder ein öffentlich-rechtliches Sondervermögen, ist ausschließlicher Gerichtsstand für alle aus dem Vertragsverhältnis unmittelbar oder mittelbar ergebenden Streitigkeiten unser Geschäftssitz in Baunach.





1. Validity
  - a) All agreements and offers between us and our clients are based on the following terms and conditions. Changes as well as deviating conditions of the client will only be included in the contract when we expressly agree to it; the same applies to the exclusion of these terms and conditions.
  - b) The terms and conditions also apply to future deliveries, services and offers, also when these are not agreed to again in a separate contract.
  - c) The terms and conditions apply exclusively to clients who are contractors in terms of § 14 BGB (German Civil Code), a legal entity under public law and a public law special fund (§ 310 BGB).
  - d) Even if these terms and conditions are made available in English or any other language, the German text shall prevail.
  - e) Legally relevant declarations and notifications by the supplier with respect to the contract (e. g. setting of deadlines, reminders, rescission) must be submitted in writing. "In writing" in accordance with these terms and conditions means in a written or text form (e. g. letter, email, fax). Legal formalities and other documentary proof, especially where there is doubt about the identity of the person submitting the declarations, remain unaffected.
2. Offer, conclusion of contract
  - a) Our offers are without obligation unless the offer states otherwise.
  - b) The client's purchase order constitutes a binding offer. We are entitled to accept this offer within 21 days from the purchase order date. Acceptance usually takes place in the form of an order confirmation. Service execution within this period shall also constitute acceptance of the offer.
  - c) Drawings, illustrations, descriptions, plans, brochures or similar documents attached to or underlying the offer are non-binding information that does not form part of the contract, unless it is expressly agreed in writing that such documents or specific content of these documents shall be included in the contract.
3. Prices, payment conditions
  - a) Our prices are determined – unless certain prices are expressly agreed upon – by our current price lists on the date of delivery.
  - b) All listed prices are net prices, which are subject to the respective statutory value-added tax as well as packaging and shipping costs.
  - c) In contracts with a delivery time of more than 4 months, we reserve the right to increase or decrease the agreed prices according to changes in costs, particularly for material, labour and other incidental expenses. If the increase is more than 5% of the agreed price, the client has a right to rescind the contract (termination or withdrawal).
  - d) Unless our order confirmation, invoice or an agreement states otherwise, the prices apply for immediate payment without discount.
  - e) We are entitled to carry out outstanding deliveries or services only against advance payment or the provision of security, if we, after conclusion of the contract, become aware of circumstances that significantly reduce the creditworthiness of a client and which put the payment of our outstanding accounts receivable by the client at risk.
4. Delivery, delivery time and deadline, part delivery, risk transfer, delay in acceptance
  - a) Delivery times or delivery dates specified by us are not binding, unless it is agreed that a specific delivery time or delivery date is binding. The beginning of the delivery period or deadline requires the clarification of all technical matters and the timely and proper fulfilment of obligations, particularly in respect to the obligations of cooperation of the client.
  - b) We are entitled to provide the contracted services in part deliveries, provided that this is reasonable to the client.
  - c) If delivery on call is agreed to, the client must place the request within a reasonable time.
  - d) If due to force majeure, acts of government, business closure, strikes or similar circumstances – also at our suppliers – delivery is made impossible or unduly difficult, we are released of the obligation of delivery for the duration of the delay and its consequences. If the resulting delays exceed a period of 6 weeks, both parties have the right to withdraw from the contract in terms of the affected scope of services. In the event of non-delivery or inadequate delivery by our suppliers, we are released from our delivery obligations in whole or in part. This applies only if we have made the necessary arrangements to procure the goods to be supplied by us. In this case we undertake to surrender our claims against the supplier to the client at their request. Further claims are excluded.
  - e) Delivery will be made ex-factory at the expense and risk of the client, unless otherwise agreed in a particular case.
  - f) The risk of accidental loss and accidental deterioration of the delivery passes to the haulier, carrier or other person for shipment to the client when handed over to any of these.
  - g) If the client defaults on acceptance or culpably violates other cooperation obligations, we are entitled to compensation for damages in this respect, including any additional costs (in particular storage costs). Further claims are reserved. Moreover, in deviation of f), in this case the risk of accidental loss or accidental deterioration of the delivery is passed onto the client at the time that he defaults on acceptance.
5. Liability for defects / Warranty
  - a) the statutory provisions apply to the client's rights in the event of material defects or defects of title (including wrong and short delivery, improper assembly/installation and faulty instructions), unless stipulated otherwise below. In all cases, this shall be without prejudice to the statutory provisions on the purchase of consumer goods (Section 474ff. German Civil Code) and any rights of the client arising from separately provided guarantees, especially guarantees provided by the manufacturer.
    - b) The basis of our liability for defects is above all the agreement concluded on the nature and intended use of the goods (including accessories and instructions). The following shall be considered to be agreements on the nature of the goods in accordance with this contract: all product descriptions and manufacturer specifications that are subject to the individual contract or that were made public by us (in particular in catalogues or on our internet site) at the time the contract was concluded. If there was no agreement on the nature, it must be determined in accordance with the statutory provisions whether there is a defect or not (Section 434 para. 3 German Civil Code). In this case, public statements by or on behalf of the manufacturer, especially in advertisements or on goods labels, shall prevail over statements by other third parties.
    - c) In the case of goods with digital elements or other digital content, we shall be liable for providing and, where appropriate, for updating the digital content only if this is specified explicitly in an agreement on the nature of the goods in accordance with let. b). We shall not accept liability for statements by the manufacturer and other third parties in this respect.
    - d) We shall not accept liability for defects that are known to the client at the time the contract is concluded or that the client has no knowledge of due to gross negligence (Section 442 German Civil Code). Furthermore, the client may only claim that there is a defect if he has fulfilled his inspection and notification duties without delay, as required by law (Section 377, 381 German Commercial Code). The client shall inspect building materials and other goods intended for assembly or any other kind of further processing immediately before the processing in all circumstances. If a defect is detected on delivery, during inspection or at a later date, the client shall notify us of this in writing without delay. In accordance with the statutory provisions, if the client fails to properly inspect the goods or notify us of any defects, we shall not accept liability for the defect which the client did not report to us, did not report to us on time or did not properly report to us. This also applies to goods intended for assembly, affixing or installation if, due to the breach of one of these duties, the defect is not apparent until after the processing in question. In this case the client is in particular not entitled to claim for the reimbursement of the corresponding costs ("assembly and disassembly costs").
    - e) If the delivered item is defective, we may initially choose whether we effect cure by removing the defect (repair) or by delivering a non-defective item (replacement delivery) if the type of cure we choose is not acceptable to the client in an specific case, he may reject it. Our right to refuse cure in accordance with the statutory provisions remains unaffected.
    - f) We are entitled to only effect the cure owed if the client pays the purchase price due. The client is nonetheless entitled to retain an appropriate part of the purchase price in proportion to the defect.
    - g) The client must give us the necessary time and opportunity to provide the cure owed, in particular to submit the queried goods for inspection. If a replacement is delivered, the client must return the defective item to us at our request in accordance with the statutory provisions; however, the client will not have any right to the return of the item. Cure does not entail the disassembly, removal or deinstallation of the defective item or the assembly, fitting or installation of a non-defective item if we were not originally obliged to perform these acts; this is without prejudice to any claims by the client for the reimbursement of the corresponding costs ("assembly and disassembly costs").
    - h) We shall bear or reimburse the costs incurred in inspecting the goods and effecting cure, including transport, travel, work and material costs, as well as assembly and disassembly costs, in accordance with the statutory provisions and these terms and conditions, if there is indeed a defect. Otherwise, we may require the client to reimburse the costs we incurred as a result of the client unjustifiably requesting a remedy for defects if the client knew or should have been able to recognise that there was in fact no defect.
    - i) In urgent cases, for example to avert a risk to operational security or to prevent disproportionate damage, the client is entitled to remedy the defect himself and to demand reimbursement from us for the objectively necessary expenses he thereby incurs. The client must notify us without delay if he intends to remedy the damage himself in such cases, where possible prior to doing so. This self-help entitlement does not apply if we would have been entitled to refuse cure in accordance with the statutory provisions.
    - j) If the seller misses an appropriate deadline set by the client for the purpose of cure, the client may rescind the purchase contract or reduce the purchase price in accordance with the statutory provisions. However, if the defect is insignificant, he does not have the right to rescind the contract.
    - k) The client does not have any right to the reimbursement of expenses in accordance with Section 445a German Civil Code unless the previous contract in the supply chain is a consumer goods purchase contract (Section 478, 474 German Civil Code) or a consumer contract about the supply of digital products (Sections 445c sentence 2, 327 para. 5, 327u German Civil Code) The client is entitled to the payment of damages or the reimbursement of futile expenses (Section 284 German Civil Code) only in accordance with Nos 6 and 7 below even if the goods are defective.
6. Other liability
  - a) Unless otherwise specified in these terms and conditions, including the following provisions, we shall accept liability in accordance with the statutory provisions for the breach of contractual and non-contractual duties.
  - b) We shall accept liability to pay damages – whatever the legal reason – in accordance with fault-based liability in the event of wilful and gross negligence. In the event of simple negligence, we are only liable, subject to limitation of liability (standard of care in our own affairs, insignificant breaches of duties), for
    - aa) damage based on injury to life, limb or health,
    - bb) damage based on the breach of a significant contractual duty (a duty whose fulfilment makes the proper performance of the contract possible in the first place and that the contractual partner regularly trusts and may trust us to observe); however, in this case our liability will be restricted to paying damages for foreseeable, typically occurring damage.
    - cc) The limitations of liability arising from let. b) also apply towards third parties and where duties are breached by persons (even in their favour) for whose fault we are liable in accordance with the statutory provisions. The limitations of liability do not apply if a defect was fraudulently concealed or a guarantee was given for the nature of an item or to claims of the purchaser in accordance with the German Product Liability Act.
    - dd) The purchaser can only rescind or terminate the contract due to a breach of duty that does not consist of a defect if we are liable for the breach of duty. The purchaser does not have any right to terminate the contract freely (especially in accordance with Section 650, 648 German Civil Law). Furthermore, the statutory requirements and legal consequences apply.
7. Statute of limitations
  - a) By way of derogation from Section 438 para. 1 No 3, the general statute of limitations for claims relating to material defects and defects of title shall be one year after delivery. If acceptance is agreed, the statute of limitations shall start from the date of acceptance.
  - b) If the item of goods consists of a building or an item that has been used for a building in accordance with the usual usage of that item and this usage has resulted in the defectiveness of the building (building material), the limitation period in accordance with the statutory provisions shall be five years from the date of delivery (Section 438 para. 1 No 2 German Civil Code). Further special statutory provisions on the statute of limitations shall also remain unaffected (especially Section 438 para. 1 No 1, para. 3, Section 444, 445b German Civil Code).
  - c) The above statutes of limitation in sales law also apply to contractual and non-contractual claims for damages by the purchaser based on a defect in the goods, unless the application of a regular legal statute of limitations (Section 195, 199 German Civil Code) would lead to a shorter statute of limitations in an individual case. Claims for damages by the purchaser in accordance with No 6 let. b) sentence 1 and sentence 2 (aa) and in accordance with the German Product Liability Act shall become statute-barred exclusively in accordance with the legal limitation periods.
8. Property rights
 

The client must uphold the property rights related to the delivered items, especially copyright, trademark, design rights and patent rights, regardless of whether they accrue to us or our suppliers or manufacturers. Our products are our intellectual property. The client is not allowed to recreate or copy them, to secure any property rights or otherwise exploit them in any way.
9. German Law for the Out-of-Court Settlement of Consumer Disputes (abbreviated as VSBG): We shall not be obligated nor ready at a customer's request to participate in any dispute settlement proceedings before any consumer conciliation body as authorised by mentioned law.
10. Data privacy:
 

As a customer, your personal data is collected, saved, processed and used if, insofar as and for as long as this is necessary to establish, implement or terminate the contractual relationship. Further collection, saving, processing and use of personal data will only take place if required or allowed by a legal regulation or if you have consented to this. To take steps prior to entering into the contract and to fulfil the contractual relationship or to fulfil individual purchase contracts and purchase orders, it may be necessary in particular to collect, process and use the name of persons, their address, further communication data, the VAT ID no. or even the bank data. The specific legal basis for this Art. 6 para. (1) (b) and (c) GDPR.

In all other respects we refer to our privacy policy, which can be viewed at [www.messingschlagel.com/en/privacy-policy](http://www.messingschlagel.com/en/privacy-policy).
11. Governing law and place of jurisdiction
  - a) The law of the Federal Republic of Germany applies to these terms and conditions and the contractual relationship between us and the client, to the exclusion of international uniform law, especially the United Nations Convention on Contracts for the International Sale of Goods.
  - b) If the client is a merchant as defined by the German Commercial Code, a legal person under public law or a special fund under public law, the sole place of jurisdiction for all disputes arising directly or indirectly from the contractual relationship shall be our registered office in Baunach.

In case of discrepancies, the German version of the terms and conditions shall take precedence.





1. Validez
  - a) Todos los acuerdos y ofertas entre nosotros y nuestros clientes se basan en estas condiciones generales de venta (en adelante CGV). Cualquier modificación o cambio de las condiciones por parte del cliente entrarán a formar parte del contrato solo si son confirmadas por nuestra parte de forma expresa. Lo mismo es válido para la exclusión de estas CGV.
  - b) Estas CGV son válidas también para todos los suministros, servicios y ofertas futuras, también si no se vuelven a acordar otra vez por separado.
  - c) Las CGV son válidas únicamente frente a compradores que sean empresa según el art. 14. del Código Civil Alemán, una persona jurídica de derecho público o un patrimonio separado jurídico-público (art. 310 del Código Civil Alemán).
  - d) Si bien estas CGV se pondrán a disposición del comprador en idioma español, solo la versión alemana del texto es determinante.
  - e) Las declaraciones y notificaciones legalmente relevantes del proveedor en relación con el contrato (p. ej., plazos, reclamaciones, rescisión) deberán hacerse por escrito. Por escrito en el sentido de estas Condiciones Generales de Contratación incluye la forma escrita y la forma de texto (p. ej., carta, correo electrónico, fax). Ello no afecta a los requisitos formales legales y a las pruebas adicionales, en particular, en caso de duda sobre la legitimidad del declarante.
2. Oferta, formalización del contrato
  - a) Nuestras ofertas se entienden sin compromiso, a menos que de la oferta no se deduzca algo diferente.
  - b) El pedido del cliente es una oferta en firme. Tenemos derecho a aceptar esta oferta en un plazo de 21 días a partir de la fecha de la orden de pedido. Por regla general, la aceptación tendrá lugar mediante una confirmación del pedido. La realización del servicio dentro de ese plazo equivale también a una aceptación de la oferta.
  - c) En el caso de dibujos, ilustraciones, descripciones, planos, prospectos y documentación similar que vayan unidos o sean la base de nuestras ofertas, se trata de información sin compromiso que no son parte del contrato, a no ser que se acuerde expresamente por escrito que dicha documentación, o un determinado contenido de esa documentación pase a ser materia del contrato.
3. Precios, condiciones de pago
  - a) Nuestros precios se fijarán – siempre que no se hayan acordado expresamente otros precios – de acuerdo con las listas de precios válidas en el día de envío de la mercancía.
  - b) Todos los precios indicados se entenderán netos, a los que habrá que añadir el importe correspondiente del impuesto sobre el valor añadido válido legalmente, así como los gastos de embalaje y transporte.
  - c) En los contratos con un plazo de suministro superior a 4 meses nos reservamos el derecho a elevar o reducir los precios fijados de forma correspondiente a las variaciones de costes habidas, especialmente en los costes de material, salarios y otros costes adicionales. Si el aumento es superior al 5 % del precio acordado el cliente tiene derecho a anular el contrato (cancelación o rescisión).
  - d) En tanto que de la confirmación del pedido, del acuerdo o de la factura, no se deduzca otra cosa, los precios se entienden a pagar de forma inmediata y sin deducciones.
  - e) Estamos autorizados a realizar o ejecutar los suministros o servicios pendientes solo mediante pago anticipado o prestación de garantías, si al cierre del contrato llega a nuestro conocimiento circunstancias por las que la solvencia del cliente se reduce sustancialmente, y por las que el pago por parte del cliente de nuestros cobros pendientes estaría en peligro.
4. Suministro, plazo y fecha de entrega, suministro parcial, cesión del riesgo, retraso en la recepción del suministro
  - a) Los plazos y fechas de entrega indicados por nosotros se entienden sin compromiso, a no ser que se acuerde de forma expresa un determinado plazo o fecha de entrega como obligatorio. El comienzo del plazo o fecha de entrega presume la aclaración de todas las consultas técnicas y el cumplimiento puntual y debidamente de las obligaciones del cliente, en particular de una eventual obligación de cooperación.
  - b) Tenemos derecho a ejecutar el servicio contractual en entregas parciales, en tanto que sea razonable para el cliente.
  - c) Si se acuerda un suministro a demanda, entonces el cliente debe retirar la mercancía dentro de un plazo adecuado.
  - d) Si el suministro se hace imposible o extremadamente difícil – también en caso de nuestros proveedores – por causas de fuerza mayor, medidas de las autoridades, cese de la explotación, huelga o circunstancias similares, entonces estaremos liberados de la obligación de suministro mientras que dure el impedimento y sus efectos. Si las demoras resultantes sobrepasan las 6 semanas de tiempo, ambos socios contractuales tendrán derecho a rescindir el contrato en relación con el servicio afectado. En caso de que no se realice el suministro o el suministro sea insuficiente por parte de nuestros proveedores estaremos dispensados total o parcialmente de nuestras obligaciones de suministro. Esto solo es válido si se han adoptado las medidas necesarias para la adquisición de la mercancía a suministrar por nosotros. En dicho caso nos comprometemos a ceder a nuestros clientes, a petición suya, nuestros derechos frente a los proveedores. Otros derechos no existen.
  - e) El suministro se realizará „ex fábrica” por cuenta y riesgo del cliente, a no ser que se acuerde otra cosa en cada caso particular.
  - f) El peligro de una pérdida casual o un deterioro casual del suministro pasa al cliente a partir del momento de la entrega al transportista, al porteador o a cualquier otra persona encargada de la realización del envío.
  - g) Si el cliente entra en mora de recepción o viola de forma culposa cualesquiera obligaciones de cooperación, estamos autorizados a exigir indemnización por los daños ocasionados, inclusive los eventuales gastos adicionales surgidos (especialmente gastos de almacenamiento). Nos reservamos el derecho por reclamaciones de mayor alcance. Si se dan las condiciones previas del apartado f), el riesgo de una eventual pérdida o empeoramiento del objeto de la compra pasa al cliente en el momento en el que éste ha incurrido en mora de recepción o de pago.
5. Responsabilidad por defectos/garantía legal
  - a) Se aplicarán las disposiciones legales a los derechos del cliente

- en caso de defectos materiales y vicios jurídicos (incluida la entrega incorrecta o en cantidad insuficiente, así como el montaje/instalación inadecuados o instrucciones deficientes), a menos que se estipule lo contrario a continuación. No se verán afectadas las disposiciones legales sobre la compraventa de bienes de consumo (art. 474 y ss. del Código Civil alemán) y los derechos del cliente derivados de garantías emitidas por separado, en particular por parte del fabricante.
- b) La base de nuestra responsabilidad por defectos es, ante todo, el acuerdo alcanzado sobre la calidad y el uso previsto de la mercancía (incluidos los accesorios y las instrucciones). Se consideran acuerdo sobre la calidad en este sentido todas las descripciones de productos y especificaciones del fabricante que sean objeto del contrato individual o que hayamos publicado (en particular en catálogos o en nuestra página de Internet) en el momento de la celebración del contrato. En la medida en que la calidad no se haya acordado, se valorará si existe o no un defecto conforme a la normativa legal (art. 434, apdo. 3 del Código Civil alemán). Las declaraciones públicas realizadas por el fabricante o en su nombre, en particular en la publicidad o en la etiqueta de los productos, prevalecen sobre las declaraciones realizadas por otros terceros.
- c) En el caso de mercancía con elementos digitales u otros contenidos digitales, solo deberemos poner a disposición y, dado el caso, actualizar los contenidos digitales en la medida en que ello se derive expresamente de un acuerdo de calidad conforme a b). No asumimos ninguna responsabilidad por las declaraciones públicas realizadas por el fabricante y otros terceros.
- d) Por principio, no responderemos de los defectos de los que el cliente tenga conocimiento en el momento de la celebración del contrato o de los que no tenga conocimiento por negligencia grave (art. 442 del Código Civil alemán). Además, las reclamaciones del cliente por defectos presuponen que haya cumplido con su obligación legal de examen y notificación (art. 377, 381 del Código Civil alemán). En el caso de materiales de construcción y otras mercancías destinadas a la instalación o a otras transformaciones, deberá realizarse una inspección inmediatamente antes de la transformación. Si se detecta un defecto durante la entrega, la inspección o en cualquier momento posterior, se nos deberá notificar por escrito sin demora. Si el cliente no inspecciona correctamente la mercancía y/o no notifica los defectos, nuestra responsabilidad por el defecto no notificado o no notificado a tiempo o no notificado correctamente quedará excluida de conformidad con las disposiciones legales. En el caso de mercancía destinada al montaje, la fijación o la instalación, esto también se aplicará si el defecto solo se hizo evidente después de la transformación correspondiente como resultado del incumplimiento de una de estas obligaciones; en este caso, el cliente no tendrá, en particular, derecho al reembolso de los costes correspondientes («costes de desmontaje y montaje»).
- e) Si el objeto suministrado es defectuoso, podemos elegir en primer lugar entre el cumplimiento tardío por subsanación del defecto (reparación) o la entrega de un objeto sin defectos (sustitución). Si la forma de cumplimiento tardío elegida por nosotros es inadmisibles para el cliente en el caso concreto, éste podrá rechazarla. Ello no afecta a nuestro derecho a rechazar el cumplimiento tardío según las condiciones legales.
- f) Tenemos derecho a condicionar el cumplimiento tardío al pago por parte del cliente del precio de compra adeudado. Sin embargo, el cliente tendrá derecho a retener una parte razonable del precio de compra proporcional al defecto.
- g) El cliente deberá concedernos el tiempo y la oportunidad necesarios para el cumplimiento tardío, en particular la entrega de la mercancía reclamada para su inspección. En caso de sustitución, el cliente deberá devolvernos el objeto defectuoso a petición nuestra de conformidad con las disposiciones legales; no obstante, el cliente no tiene derecho a devolución. El cumplimiento tardío no incluye el desmontaje, la retirada o la desinstalación del objeto defectuoso ni el montaje, la colocación o la instalación de un objeto libre de defectos si no estábamos obligados originalmente a realizar estos servicios; ello no afecta al derecho del cliente a reclamar el reembolso de los costes correspondientes («costes de desmontaje y montaje»).
- h) Sufragaremos o reembolsaremos los gastos necesarios para la inspección y el cumplimiento tardío, en particular los costes de transporte, desplazamiento, mano de obra y material y, en su caso, los costes de desmontaje y montaje, de conformidad con las disposiciones legales y las presentes Condiciones Generales de Contratación, si realmente existe un defecto. En caso contrario, podremos exigir al cliente el reembolso de los gastos en que hayamos incurrido como consecuencia de la solicitud injustificada de subsanación del defecto si el cliente sabía o podría haber detectado que en realidad no existía ningún defecto.
- i) En casos urgentes, p. ej., si peligra la seguridad de funcionamiento o para evitar daños desproporcionados, el cliente tiene derecho a subsanar él mismo el defecto y a exigimos el reembolso de los gastos objetivamente necesarios para ello. Se nos deberá informar inmediatamente de cualquier actuación propia, a ser posible con antelación. El cliente no tendrá derecho a actuar por su cuenta si tuviéramos derecho a rechazar el cumplimiento tardío correspondiente de acuerdo con las disposiciones legales.
- j) En caso de expirar sin éxito el plazo razonable fijado por el cliente para el cumplimiento tardío o cuando sea prescindible en virtud de las disposiciones legales, el cliente podrá rescindir el contrato de compraventa o reducir el precio de compraventa de conformidad con las disposiciones legales. Sin embargo, en caso de defecto insignificante, no existe derecho de rescisión.
- k) Quedan excluidas las reclamaciones del cliente de compensación de gastos según el art. 445a apdo. 1 del Código Civil alemán, a menos que el último contrato en la cadena de suministro sea una compraventa de bienes de consumo (art. 478, 474 del Código Civil alemán) o un contrato en materia de consumo para el suministro de productos digitales (art. 445c p. 2, 327 apdo. 5, 327u del Código Civil alemán). El cliente también tendrá derecho a reclamar por daños y perjuicios o a la compensación de gastos acaecidos en vano (art. 284 del Código Civil alemán) en caso de defectos en la mercancía solo de conformidad con los siguientes números 6 y 7.

6. Otros tipos de responsabilidad
  - a) Siempre que no se desprenda lo contrario de las presentes Condiciones Generales de Contratación, incluidas las siguientes disposiciones, en caso de incumplimiento de las obligaciones contractuales y extracontractuales responderemos conforme a las disposiciones

- legales.
  - b) En caso de dolo y negligencia grave, responderemos de los daños y perjuicios –independientemente de los fundamentos jurídicos– en el ámbito de la responsabilidad culposa. En caso de negligencia leve, solo responderemos, sin perjuicio de las limitaciones legales de responsabilidad (p. ej., diligencia de los propios asuntos; incumplimiento insignificante de obligaciones), de:
    - aa) de los daños derivados de atentados contra la vida, la integridad física o la salud,
    - bb) de los daños derivados del incumplimiento de una obligación contractual esencial (obligación cuyo cumplimiento es un requisito previo para la correcta ejecución del contrato y en cuyo cumplimiento confía y puede confiar regularmente la parte contratante); sin embargo, en este caso, nuestra responsabilidad se limitará a la indemnización por los daños previsibles y habituales.
  - c) Las limitaciones de responsabilidad resultantes de la b) también se aplicarán a terceros, así como en caso de incumplimiento de obligaciones por parte de personas (también a su favor) de cuya culpa seamos responsables según las disposiciones legales. No se aplicarán en la medida en que se haya ocultado dolosamente un defecto o se haya asumido una garantía de las características de la mercancía, ni por reclamaciones del comprador en virtud de la Ley alemana sobre responsabilidad del productor.
  - d) En caso de incumplimiento de obligaciones que no consista en un defecto, el comprador solo podrá desistir o rescindir el contrato si somos responsables de dicho incumplimiento. Queda excluido el derecho de rescisión libre del comprador (en particular según los art. 650, 648 del Código Civil alemán). Además, se aplicarán los requisitos legales y las consecuencias jurídicas.
7. Prescripción
  - a) No obstante lo dispuesto en el art. 438 (1) nº 3 del Código Civil alemán, el plazo de prescripción general para reclamaciones derivadas de defectos materiales y vicios jurídicos será de un año a partir de la entrega. En la medida en que se haya acordado un control de inspección, el plazo de prescripción comenzará a contar a partir del control de inspección.
  - b) Si la mercancía es una construcción o un objeto que ha sido utilizado para una construcción de acuerdo con su uso habitual y ha causado su deficiencia (material de construcción), el plazo de prescripción será de 5 años a partir de la entrega de acuerdo con la disposición legal (art. 438 apdo. 1 nº 2 del Código Civil alemán). Tampoco se verán afectadas otras disposiciones legales especiales en materia de prescripción (en particular, el art. 438, apdo. 1, nº 1, apdo. 3, y los art. 444 y 445b del Código Civil alemán).
  - c) Los plazos de prescripción anteriores de la legislación sobre compraventa también se aplican a las reclamaciones contractuales y extracontractuales por daños y perjuicios del comprador basadas en un defecto de la mercancía, a menos que la aplicación del plazo de prescripción legal ordinario (art. 195, 199 del Código Civil alemán) condujera a un plazo de prescripción más corto en el caso particular. Las reclamaciones del comprador por daños y perjuicios en virtud del nº 6 b) p. 1 y 2 (aa), así como en virtud de la Ley alemana sobre responsabilidad del producto prescribirán exclusivamente conforme a los plazos de prescripción legales.
8. Derechos de propiedad
 

El cliente debe velar por la propiedad intelectual, especialmente los derechos de autor, de marca, de modelos de estética y de patentes, independientemente de si nos corresponden a nosotros o a nuestros proveedores o fabricantes. Nuestros productos son nuestra propiedad intelectual. El cliente no está autorizado a copiarlos, a asegurarse los derechos de propiedad o a explotarlos en ninguna otra forma.
9. Le informamos que, de acuerdo con la Ley alemana de resolución de litigios del consumidor (VSBG en sus siglas en alemán), no estamos dispuestos ni obligados a participar en procedimientos de resolución de conflictos ante organismos de arbitraje de consumo en virtud de la Ley alemana de resolución de litigios del consumidor.
10. Protección de datos:
 

Se recopilarán, almacenarán, procesarán y utilizarán datos personales de usted como cliente en la medida y durante el tiempo que sea necesario para el establecimiento, la ejecución o la finalización de la relación contractual. La recopilación, el almacenamiento, el tratamiento y el uso de los datos personales solo se llevarán a cabo si así lo exige o permite la ley o si usted ha dado su consentimiento. Para la ejecución de medidas precontractuales y para el cumplimiento de la relación contractual o para el cumplimiento de contratos y pedidos de compraventa individuales, puede ser necesaria en particular la recopilación, el procesamiento y el uso del nombre de personas, su dirección, otros datos de comunicación, el número de identificación fiscal o los datos bancarios. La base jurídica es, en particular, el art. 6, apartado 1, letras b) y c) del RGPD.

Por lo demás, consulte nuestra política de protección de datos, disponible en <https://www.messingschlagler.com/es/politica-de-privacidad>.
11. Elección de ley aplicable y fuero
  - a) Las presentes Condiciones Generales de Contratación y la relación contractual entre nosotros y el cliente se regirán por las leyes de la República Federal de Alemania, con exclusión del derecho internacional uniforme, en particular la Convención de las Naciones Unidas sobre los Contratos de Compraventa Internacional de Mercancías.
  - b) Si el cliente es un comerciante en el sentido del Código de Comercio alemán, una persona jurídica de derecho público o un patrimonio especial de derecho público, la jurisdicción exclusiva para todos los litigios derivados directa o indirectamente de la relación contractual será nuestro domicilio social en Baunach.

En caso de contradicciones prevalecerá la versión alemana de las CGV.

<b>A</b> bschleppseil	539	<b>G</b> abeln	359 - 369, 628, 639 - 641
Achsmuttern und -schrauben	280	Garmin Halter	115
Achsverlängerungen BMX	241	Gepäck-Fahrradanhänger	531 - 533
AirTag Halter	113, 263	Gepäckgurte	440
Alarmanlagen	101, 113, 263	Gepäcktaschen	23 - 44, 531, 533
Allgemeine Geschäftsbedingungen	683 - 685	Gepäckträger	442 - 447
Anhänger & Zubehör	531 - 536	Klingeln	113, 407 - 416
Auftragsformular	682	Griffe	391 - 405
Außenhüllen	310 - 317	<b>H</b> andschuhe	563 - 565
Ausstellungsstände & Zubehör	424 - 430	Helme	572 - 578
<b>B</b> atterie-/Akkulampen	46 - 71, 75 - 76, 78, 80 - 81	Hosen-/Armband	17 - 18
Batterien	88, 628, 630, 633 - 637	Hundeanhänger/-stange	535 - 536
Bekleidung	561 - 565	Hupen	416
Beleuchtungen	46 - 88, 647 - 651	<b>I</b> nnenlager	282 - 286
Bereifungen	468 - 529	Innenzüge	312 - 314
Bike Fitting System	606	<b>K</b> abel	82, 629 - 638
Bikepacking	23 - 30	Kabelbinder	680
Birnchen	88	Kassetten	653 - 660, 665 - 673, 678 - 679
Bowdenzüge	312 - 313	Kassettenfreilaufkörper	245 - 246
Bremsbeläge	293 - 298, 304 - 309	Ketten & Zubehör	177 - 201, 643
Bremsen & Bremsteile	288 - 315, 642, 656 - 670	Kettenblätter	274 - 275
Bremsscheiben	291 - 292, 643, 656 - 657, 661	Kettenradgarnituren & Zubehör	266 - 281
Brillen	568 - 570	Kettenreinigungsgeräte	198
Bügelschlösser	103	Kettenschutz	276, 280 - 281
<b>C</b> omputer	107 - 112	Kettenspanner	199
<b>D</b> rehmomentschlüssel	612 - 613	Kettenstrebenschutz	200 - 201
Dynamos & Teile	85 - 87, 242 - 243, 662	Kettenverschlussglieder	190 - 192, 196 - 197
<b>E</b> -Bike Antriebe	629, 637	Kinderanhänger	534 - 535
E-Bike Akkus	628, 633 - 637	Kinderradzubehör	538, 546
E-Bike Beleuchtung	72 - 73, 78 - 79, 647 - 651	Kindersitze	158 - 160
E-Bike Displays	629, 638	Klebeband	680
E-Bike Zubehör	644 - 645	Körbe	433 - 439
E-Mobility Solutions	623 - 643	Kugellager	248, 281, 286, 356
E-Scooter	542 - 543	Kurbelarme	278 - 279
Einräder	547 - 548	Kurbelkeile	280
Endhülsen	310 - 311, 316 - 317	<b>L</b> aufräder	336 - 346
<b>F</b> ahrradgarage	566	Laufertaschen	41
Fahrradhalter	424 - 431	Lenkerbänder	395 - 396
Faltwerkzeuge	603, 617 - 618	Lenker	371 - 378
Federgabeln	360 - 364, 639 - 641	Lenkerendstopfen	396
Federungselemente	556, 641	Lenkertaschen	24, 26 - 28, 30 - 31, 34 - 35
Felgen	330 - 334	Lenkerzusatzgriffe	388 - 389
Felgenbänder	463 - 466	Lenkungsdämpfer	424
Flaschen	255 - 257	Lernlaufräder	545
Flaschenhalter	257 - 264	Lichtkabel	82
Flickzeug	464, 600, 603, 614 - 615	Luftpumpen & Zubehör	449 - 460

<b>M</b> odulares Haltersystem	114	Schrauben	621
Montage-Ständer	619 - 620	Schuhplatten	225
Multifunktionstücher	562	Schutzbleche	319 - 328
<b>N</b> aben	227 - 244	Shimano-Komponenten	653 - 662
Nabendynamos	85 - 86, 242 - 243	Skihelme	577
Netze	328	Smartphonetaschen & -halter	26, 29, 36 - 39, 43
Nippel	172 - 173	Speichen	167 - 170
<b>P</b> annenschutz	464 - 465	Spiegel	162 - 165
Pedale	203 - 225	Sram-Komponenten	639 - 643
Pedalhaken/-riemen	224	Ständer	418 - 430
Pedalreflektoren	224	Steckachse	227, 229, 233, 536, 632 - 633
Pflegemittel	579 - 584	Steuersätze, Steuersatzhalter & Zubehör	348 - 358
Promotionmaterial	475, 681	Sturmhaube	577
Pumpen & Zubehör	449 - 460	Stützräder	431
<b>R</b> ahmen	550 - 555, 626, 630 - 636	<b>T</b> andem-Stange	538
Rahmenschlösser	104 - 105	Transportschutz	41, 566
Rahmentaschen	24, 26, 37 - 39	Triathlonaufsatz	378
Reflektoren	17 - 21, 83 - 84, 224	Trink-Rucksack	25, 42 - 43
Reflexartikel	17 - 21	Tubeless	463 - 465
Regenbekleidung	563	<b>U</b> mwerfer	658 - 659, 664 - 666, 673 - 674
Reifen	468 - 529	<b>V</b> entile & Zubehör	463 - 467
Reklamationsabwicklung	682	Verpackungen	15, 172, 680
Rollentrainer	539 - 540	Vertreter	691
Roller	542 - 544	Vorbauten	380 - 387
Rücklichter	47 - 50, 53 - 57, 61 - 71, 77 - 81, 651	<b>W</b> andhalter	425
Rucksäcke	25, 27, 32, 42 - 43	Werkstattwagen	586 - 587
Rücktritt-Bremsnaben	243, 244, 662	Werkzeuge	171 - 172, 192, 288 - 289, 586 - 618
<b>S</b> ättel	116 - 142	Werkzeugkoffer	596, 603, 616
Satteldecken	143 - 144	<b>Z</b> ahnkränze	197, 241, 244, 653 - 660, 665 - 673, 678 - 679
Sattelmatten	146 - 147	Zentrierständer	170, 588, 601
Sattelstützen	148 - 156, 643		
Sattelstützadapter	156		
Satteltaschen	23, 27, 40, 44		
Schaltaugen	552, 557 - 559, 591, 627, 630 - 632, 643		
Schalthebel	653 - 662, 664 - 676		
Schaltkettchen	675		
Schaltungsrädchen	677		
Schaltungsschutz	675		
Schaltwerke	653 - 660, 664 - 674		
Schaltzüge	312 - 314		
Scheibenbremsen & Zubehör	288 - 298, 642, 656 - 657, 661		
Scheibenbremsnaben	227 - 235		
Scheinwerfer	72 - 76, 647 - 649		
Schläuche	472 - 475, 522 - 523		
Schlösser	90 - 105		
Schnellspanner	249 - 253		

<b>A</b> gents	691	<b>D</b> epot Hanger	425
Air Horns	416	Derailleur Guards	675
AirTag bracket	113, 263	Derailleur Hanger	552, 557 - 559, 591, 627, 630, 632, 643
Alarm	101, 113, 263	Disc Brake Hubs	227 - 235
Axle Bolts and Nuts	280	Disc Brakes & Accessories	288 - 298, 642, 656 - 657, 661
Axle Pegs BMX	241	Display Stands & Accessories	424 - 430
<b>B</b> aby Seats	158 - 160	Dog Trailer & Guide	535 - 536
Backpacks	25, 27, 32, 42 - 43	Duct Tape	680
Bags	23 - 44, 531, 533	Dynamo & Parts	85 - 87, 242 - 243, 662
Bar Ends	388 - 389	<b>E</b> -Bike Lighting	72 - 73, 78 - 79, 647 - 651
Baskets	433 - 439	E-Bike Batteries	628, 633 - 637
Batteries	88, 628, 630, 633 - 637	E-Bike Displays	629, 638
Batterylamps	46 - 71, 75 - 76, 78, 80 - 81	E-Bike Motors	629, 637
Bells	113, 407 - 416	E-Mobility Solutions	623 - 643
Bicycle Care	579 - 584	End Caps	310 - 311, 316 - 317
Bicycle Garage	566	E-Scooter	542 - 543
Bike Case	41	<b>F</b> olding Tools	603, 617 - 618
Bikepacking	23 - 30	Forks	359 - 369, 628, 639 - 641
Bike & Sportswear	561 - 565	Frame Bags	24, 26, 37 - 39
Bike Fitting System	606	Frame Locks	104 - 105
Bike Stand	418 - 430	Frames	550 - 555, 626, 630 - 636
Bottle Cages	257 - 264	Front Derailleurs	658 - 659, 664 - 666, 673 - 674
Bottom Brackets	282 - 286	<b>G</b> armin brackets	115
Brake Discs	288 - 298, 643, 656 - 657, 661	General Business Conditions	683 - 685
Brake Pads	293 - 298, 304 - 309	Glasses	568 - 570
Brakes & Parts	288 - 315, 642, 656 - 670	Gloves	563 - 565
Bulbs	88	Grips	391 - 405
Bungee Cords	440	<b>H</b> andlebar Bags	24, 26 - 28, 30 - 31, 35
<b>C</b> able Ties	680	Handlebars	371 - 378
Cables	82, 629 - 638	Handlebar Plugs	396
Carriers	442 - 447	Handlebar Tapes	395 - 396
Cassette Bodies	245 - 246	Head Lamps	72 - 76, 647 - 649
Cassettes	653 - 660, 665 - 673, 678 - 679	Head Sets	348 - 358
Chains & Accessories	177 - 201, 643	Head Wear	562, 577
Chain Adjuster	199	Helmets	572 - 578
Chain Cleaners	198	Hub Dynamos	85 - 86, 242 - 243
Chain Guards	276, 280 - 281	Hubs	227 - 244
Chainrings	274 - 275	<b>I</b> ndicator Chain	675
Chain Stay Protectors	200 - 201	Inner Cables	312 - 314
Chainwheel Sets & Accessories	266 - 281	<b>L</b> ight Cables	82
Children Bike Accessories	538, 546	Lighting Products	46 - 88, 647 - 651
Children Trailers	534 - 535	Locks	90 - 105
Cleats	225	Luggage Bicycle Trailers	531 - 533
Coaster Brake Hubs	243, 244, 662		
Complaints Handling	682		
Computers	107 - 112		
Connecting Links	190 - 192, 196 - 197		
Cotter Pins	280		
Cranks	278 - 279		



Mirrors	162 - 165	Stabilizers	431
Modular bracket system	114	Steering Damper	424
Mudguards	319 - 328	Stems	380 - 387
Nets	328	Suspension Forks	360 - 364, 639 - 641
Nipples	172 - 173	Tandem Tow Bar	538
Order Sheet	682	Thru Axles	227, 229, 233, 536, 632 - 633
Outer Casings	310 - 317	Tires	468 - 529
Packagings	15, 172, 680	Tool Cases	596, 603, 616
Pedal Clips & Straps	203 - 225	Tools	171 - 172, 192, 288 - 289, 586 - 618
Pedal Reflectors	224	Torque wrenches	612 - 613
Pedals	203 - 225	Tow rope	539
Promotion Material	475, 681	Trailers & Accessories	531 - 536
Pulleys	677	Tri bars	378
Pumps	449 - 460	Trousers & Arm Bands	17 - 18
Puncture Protection	464 - 465	Truing Stand	170, 588, 601
Puncture Repair Kit	464, 600, 603, 614 - 615	Tubeless Kit	463 - 465
Quick Releases	249 - 253	Tubes	472 - 475, 522 - 523
Rain Clothes	563	Unicycles	547 - 548
Rear Derailleurs	653 - 660, 664 - 674	Valves	463 - 467
Rear Lights	47 - 50, 53 - 57, 61 - 71, 77 - 81, 651	Water Backpack	25, 42 - 43
Rear Shocks	556, 641	Water Bottles	255 - 257
Reflectors	17 - 21, 83 - 84, 224	Wheel Sets	336 - 346
Reflex Products	17 - 21	Wheel Set Bags	41
Rims	330 - 334	Workstands	619 - 620
Rimtapes	463 - 466	Workstation	586 - 587
Roll Exercise Trainer	539 - 540		
Running Bikes	545		
Saddle Bags	23, 27, 40, 44		
Saddle Covers	143 - 144		
Saddles	116 - 142		
Scooters	542 - 544		
Screws	621		
Sealed Ball Bearings	248, 281, 286, 356		
Seat Posts	148 - 156, 643		
Seat Post Adapter	156		
Seat Tube Clamps	146 - 147		
Shackle Locks	103		
Shiftlevers	653 - 662, 664 - 676		
Shimano Components	653 - 662		
Side Stands	418 - 423		
Ski Helmets	577		
Smartphone Bags & Brackets	26, 29, 36 - 39, 43		
Spokes	167 - 170		
Sprockets	197, 241, 244, 653 - 660, 665 - 673, 678 - 679		
Sram Components	639 - 643		

 Your direct connection +49 9544 9444 – ...



**Dennis Schömburg**  
**CEO**  
Tel: -8291  
rj@messingschlager.com



**Benno Messingschlager**  
**Member of the Board**  
Tel: -17  
as@messingschlager.com



**Toni Messingschlager**  
**Prokurist,**  
**IT, Logistics, Customs**  
Tel: -12  
td@messingschlager.com



**Christian Heymanns**  
**Head of E-Mobility**  
**& Service**  
Tel: -882  
hc@messingschlager.com



**Matthias Raab**  
**Head of Procurement**  
**& Product Category**  
**Management**  
Tel: -3446  
mr@messingschlager.com



**Patrick J. Cunnane**  
**CEO**  
**Messingschlager USA**  
Tel: +12 6725 109 72  
pjc@cyclefg.com



**Martin Buchta**  
**Communication**  
Tel: -63  
bt@messingschlager.com



**Christoph Helmrich**  
**E-Commerce & Sales**  
**BENELUX** BE, LUX, NL  
Tel: -3440  
hec@messingschlager.com



**Stephan Czepluch**  
**OEM Sales**  
**International**  
Tel: -64  
cz@messingschlager.com



**Thomas Kühnlein**  
**Sales Germany**  
Tel: -28  
kt@messingschlager.com



**Michael Hälterlein**  
**Sales DACH**  
AT, DE, CH, LI  
Tel: -25  
mh@messingschlager.com



**Frank Brückner**  
**Sales Europe** CY, DK, ES,  
FI, FR, GR, IT, NO, SE  
Tel: -59  
fb@messingschlager.com



**Iain Pollitt-Walmsley**  
**Sales UK/IRE**  
Tel: +44 754 398 30 50  
ipw@messingschlager.com



**Heike Iffland**  
**Sales Central/**  
**Eastern Europe**  
BA, BG, CZ, EE, HR, HU, LT,  
LV, MK, PL, RO, RS, SI, SK  
Tel: -23  
if@messingschlager.com



**Lukas Stasiuk**  
**Sales Central/**  
**Eastern Europe**  
AM, AZ, BY, CZ, GE, KG,  
KZ, LV, MD, PL, RU, UA, UZB  
Tel: -43  
ls@messingschlager.com



**Robert Mrkos**  
**Sales Central/**  
**Eastern Europe**  
BG, CZ, EE, HU, LT, LV,  
PL, RU, RO, RS, SK  
Tel: +420 736 690 666  
rmr@messingschlager.com



**Andreas Schmidt**  
**OEM Sales**  
**International**  
DE, IL, KR, PT, TW, VN  
Tel: -3443  
asc@messingschlager.com



**Nadine Schmuck**  
**Sales Europe, US,**  
**Middle East & Overseas**  
AE, AL, AR, AU, BR, CA, CL, CN,  
CO, CU, HK, ID, IN, IS, MT, NG,  
NZ, TN, TR, US, UY, ZA  
Tel: -76  
nw@messingschlager.com